

# LM2754

## 800mA Switched Capacitor Flash LED Driver with Time-Out Protection

### General Description

The LM2754 is an integrated low noise, high current switched capacitor DC/DC converter with four regulated current sinks. The device is optimized for driving 1 to 4 high power white LEDs in parallel with a maximum current of 800mA. Maximum efficiency is achieved over the input voltage range by actively selecting the proper gain based on the LED forward voltage and current requirements.

Two external low power resistors set the desired current for Torch and Flash modes. The TX pin allows the device to be forced into Torch mode during a Flash pulse, allowing for synchronization between the RF power amplifier pulse and Flash/Torch modes. To protect the device and Flash LEDs, internal Time-Out circuitry turns off the LM2754 in case of a faulty prolonged Flash mode. Internal soft-start circuitry limits the amount of inrush current during start-up.

The LM2754 is available in a small 24-pin thermally enhanced LLP package.

### Features

- Up to 800mA Output Current
- Wide Operating Input Voltage Range: 2.8V to 5.5V
- Drives 1, 2, 3 or 4 LEDs in Parallel
- Ability to Disable One Current Sink Via the SEL Pin to Accommodate 3-LED Flash Modules
- Time-Out Circuitry Limits Flash Duration to 1 Second
- TX Input Ensures Synchronization with RF Power Amplifier Pulse
- Adaptive 1x, 1.5x and 2x Gains for Maximum Efficiency
- 1MHz Constant Frequency Operation
- Output Current Limit
- True Shutdown Output Disconnect
- <math><1\mu\text{A}</math> Shutdown Current
- Internal Soft-Start Limits Inrush Current
- No Inductor Required
- Total Solution Size without LED <math><28\text{mm}^2</math>
- Low Profile 24-Pin LLP Package (4mm x 4mm x 0.8mm)

### Applications

- Camera Flash in Mobile Phones
- Flash for Digital Cameras
- Supplies for DSP's, Microprocessors, Memory, MP3 Players, Pagers, Other Portable Devices

### Typical Application Circuit

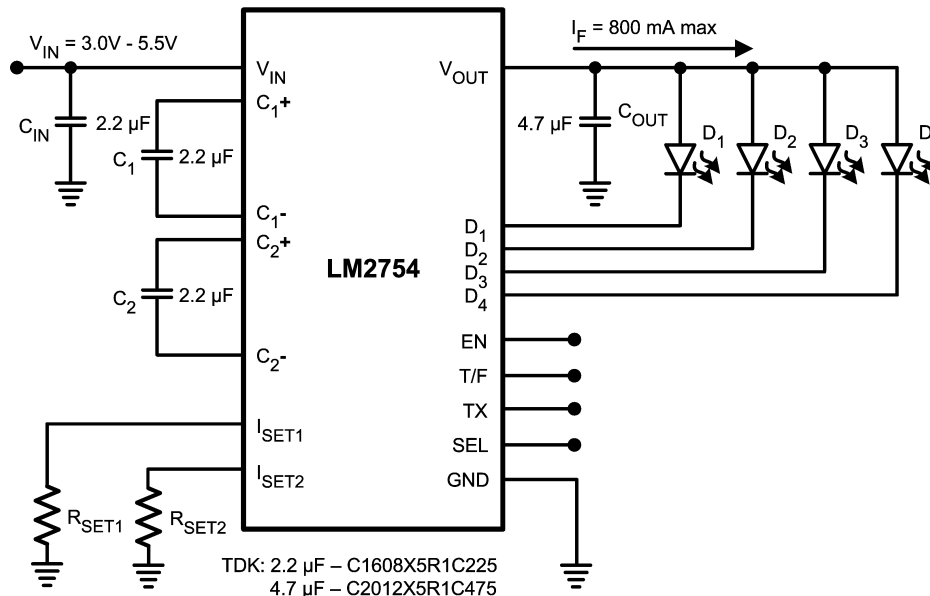

20202801

## Connection Diagram

**LM2754**  
**24-pin No-Pullback Leadless Leadframe Package (LLP-24)**  
**4mm x 4mm x 0.8mm**  
**NS Package Number SQA24A**

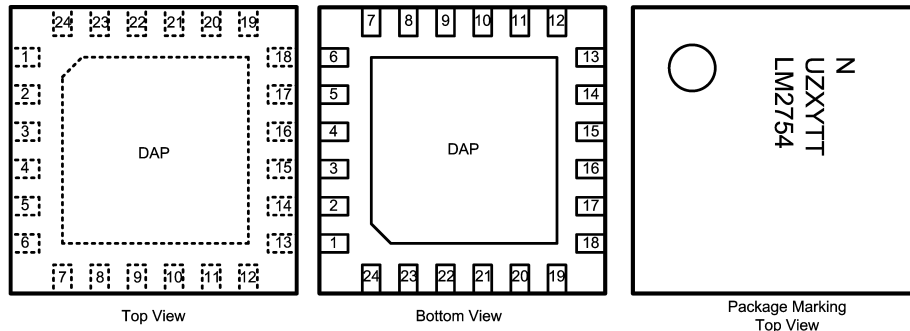

**Note:** The actual physical placement of the package marking will vary from part to part. The package marking "N" is a placeholder for the National Semiconductor Logo. The package marking "U" designates the Fab Code. "Z" is the Assembly Plant Code. "XY" is a NSC internal Date Code and "TT" is Lot Code for die traceability. These codes will vary considerably. LM2754 identifies the device (part number, option, etc.).

20202802

## Pin Descriptions

Pin	Name	Description
23,24	$V_{INSW}$	Input Voltage Connection for Switch Array. Pins 23 and 24 are connected internally on the die. Connect $V_{IN}$ and $V_{INSW}$ pins together.
22	$V_{IN}$	Input Voltage Connection. Connect $V_{IN}$ and $V_{INSW}$ pins together.
8	$V_{OUT}$	Output Voltage. Connect to LED Anodes.
12, 13, 14, 15	D1, D2, D3, D4*	Regulated Current Sink Inputs. (* See <b>SEL PIN</b> description)
1, 2, 7, 5	$C_{1+}$ , $C_{1-}$ , $C_{2+}$ , $C_{2-}$	Flying Capacitor Connections.
3	$GND_{SW}$	Switch Array Ground Connection. Connect GND and $GND_{SW}$ pins together.
9, 16, 17	GND	Ground Connection. Connect GND and $GND_{SW}$ pins together.
21	EN	Enable Control Pin. Logic High = Normal Operation in Torch Mode. Logic Low = Device Shut-Down. (See <b>Note</b> )
20	T/F	Torch/Flash Control Pin. Logic High = Flash Mode. Logic Low = Torch Mode. Device must be enabled for Torch or Flash to operate. (See <b>Note</b> )
10, 11	$I_{SET1}$ , $I_{SET2}$	Current Set Resistor Connections. Connect 1% resistors to ground to set the desired current through the LEDs. LED current is approximated by the equation: $800 \times (1.25V \div R)$ . This equation corresponds to the current through one current sink. Total LED current is equal to the sum of currents through all current sinks connected to the LED. The equation used for Torch ( $I_{SET1}$ ) and Flash ( $I_{SET2}$ ) resistors are the same.
19	TX	RF PA synchronization control pin. Logic High = Force Torch Mode. Logic Low = Normal Operation. (See <b>Applications Information</b> section for the full operational description) (See <b>Note</b> )
18	SEL	$D_4$ Control Pin. Logic Low = Normal 4-LED Operation. Logic High = Disable $D_4$ LED Input. Connect $D_4$ to $V_{OUT}$ when not used. (See <b>Note</b> )
4, 6	No Connect	Do not connect to any node.
<b>Note:</b> EN, T/F, TX, and SEL pins each have a 500k $\Omega$ resistor connected internally to GND		

## Ordering Information

Order Number	Package Description	Package Marking	Supplied as Tape and Reel (Units)
LM2754SQ	No-Pullback	UZXYYTT	1000
LM2754SQX	LLP-24	LM2754	4500

**Absolute Maximum Ratings** (Notes 1, 2)

If Military/Aerospace specified devices are required, please contact the National Semiconductor Sales Office/Distributors for availability and specifications.

$V_{IN}$ , $V_{OUT}$ pins	-0.3V to 6.0V
EN, T/F, TX, SEL pins	-0.3V to ( $V_{IN} + 0.3V$ ) w/ 6.0V max

Continuous Power Dissipation (Note 3)	Internally Limited
Junction Temperature ( $T_{J-MAX-ABS}$ )	150°C
Storage Temperature Range	-65°C to 150°C
Lead Temp. (Soldering, 5 sec.)	260°C
ESD Rating (Note 4)	
Human Body Model	2kV

**Electrical Characteristics** (Notes 2, 7)

Limits in standard typeface are for  $T_J = 25^\circ\text{C}$ , and limits in **boldface** type apply over the full operating junction temperature range (-40°C to +125°C). Unless otherwise noted, specifications apply to the LM2754 Typical Application Circuit (pg.1) with  $V_{(IN, INSW)} = 3.6V$ ,  $V_{EN} = 1.8V$ ,  $V_{T/F} = 0V$ ,  $V_{TX} = 0V$ ,  $V_{SEL} = 0V$ ,  $C_{IN} = C_1 = C_2 = 2.2\mu\text{F}$ ,  $C_{OUT} = 4.7\mu\text{F}$ . (Note 8)

Symbol	Parameter	Conditions	Min	Typ	Max	Units
$V_{SETx}$	$I_{SETx}$ Pin Voltage	$R_{SETx} = 20k\Omega$	<b>-3.5%</b>	1.244	<b>+3.5%</b>	V
$I_{Dx}/I_{SETx}$	LED Current to Set Current Ratio (Note 11)	$I_{Dx} = 50\text{mA}$ to 100mA	<b>-7%</b>	795	<b>+7%</b>	mA/mA
		$I_{Dx} = 200\text{mA}$	<b>-11.5%</b>	820	<b>+11.5%</b>	
$V_{HR}$	Current Sink Headroom Voltage (Note 10)	$I_{Dx} = 200\text{mA}$		550		mV
		$I_{Dx} = 50\text{mA}$		150		
$V_{OUT}$	Output Voltage	1x Mode, $I_{Dx} = 0\text{mA}$		4.7		V
		1.5x Mode, $I_{Dx} = 0\text{mA}$		4.7		
		2x Mode, $I_{Dx} = 0\text{mA}$		5.1		
$R_{OUT}$	Output Impedance	1x Mode		0.25		$\Omega$
		1.5x Mode		1.3		
		2x Mode		1.5		
$I_Q$	Quiescent Supply Current	1x Mode, $I_{Dx} = 0\text{mA}$		0.7		mA
		1.5x Mode, $I_{Dx} = 0\text{mA}$		3.4		
		2x Mode, $I_{Dx} = 0\text{mA}$		6.3	<b>8</b>	
$I_{SD}$	Shutdown Supply Current	$V_{EN} = 0V$		0.1	<b>1</b>	$\mu\text{A}$
$f_{SW}$	Switching Frequency		<b>0.7</b>	1	<b>1.3</b>	MHz
$V_{IH}$	Logic Input High	Input Pins: EN, T/F, TX, SEL	<b>1.2</b>			V
$V_{IL}$	Logic Input Low	Input Pins: EN, T/F, TX, SEL			<b>0.4</b>	
$I_{IH}$	Logic Input High Current (Note 9)	$V_{(EN, T/F, TX, SEL)} = 1.8V$		4		$\mu\text{A}$
$I_{IL}$	Logic Input Low Current (Note 9)	$V_{(EN, T/F, TX, SEL)} = 0V$		0.5		$\mu\text{A}$

**Note 1:** Absolute Maximum Ratings indicate limits beyond which damage to the component may occur. Operating Ratings are conditions under which operation of the device is guaranteed. Operating Ratings do not imply guaranteed performance limits. For guaranteed performance limits and associated test conditions, see the Electrical Characteristics tables.

**Note 2:** All voltages are with respect to the potential at the GND pin.

**Note 3:** Internal thermal shutdown circuitry protects the device from permanent damage. Thermal shutdown engages at  $T_J = 150^\circ\text{C}$  (typ.) and disengages at  $T_J = 120^\circ\text{C}$  (typ.).

**Note 4:** The Human-body model is a 100 pF capacitor discharged through a 1.5k $\Omega$  resistor into each pin.

**Note 5:** In applications where high power dissipation and/or poor package thermal resistance is present, the maximum ambient temperature may have to be derated. Maximum ambient temperature ( $T_{A-MAX}$ ) is dependent on the maximum operation junction temperature ( $T_{J-MAX-OP} = 125^\circ\text{C}$ ), the maximum power dissipation of the device in the application ( $P_{D-MAX}$ ), and the junction-to ambient thermal resistance of the part/package in the application ( $\theta_{JA}$ ), as given by the following equation:  $T_{A-MAX} = T_{J-MAX-OP} - (\theta_{JA} \times P_{D-MAX})$ .

**Note 6:** Junction-to-ambient thermal resistance ( $\theta_{JA}$ ) is taken from a thermal modeling result, performed under the conditions and guidelines set forth in the JEDEC standard JESD51-7. The test board is a 4 layer FR-4 board measuring 102mm x 76mm x 1.6mm. The 2 imbedded copper layers cover roughly the same area as the board. Thickness of copper layers are 70 $\mu\text{m}/35\mu\text{m}/35\mu\text{m}/70\mu\text{m}$  (2oz/1oz/1oz/2oz). Thermal vias are placed between the die attach pad in the 1st copper layer

## Electrical Characteristics (Notes 2, 7) (Continued)

and the 2nd copper layer. Ambient temperature in simulation is 22°C, still air. Power dissipation is 1W.

The value of  $\theta_{JA}$  of the LM2754 in LLP-24 could fall in a range as wide as 35°C/W to 150°C/W (if not wider), depending on PWB material, layout, and environmental conditions. In applications where high maximum power dissipation exists (high  $V_{IN}$ , high Gain, high  $I_{OUT}$ ), special care must be paid to thermal dissipation issues. For more information on these topics, please refer to **Application Note 1187: Leadless Leadframe Package (LLP)** and the **Power Efficiency and Power Dissipation** section of this datasheet.

**Note 7:** Min and Max limits are guaranteed by design, test, or statistical analysis. Typical numbers are not guaranteed, but do represent the most likely norm.

**Note 8:**  $C_{IN}$ ,  $C_{OUT}$ ,  $C_1$ ,  $C_2$ : Low-ESR Surface-Mount Ceramic Capacitors (MLCCs) used in setting electrical characteristics

**Note 9:** There is a 500k $\Omega$  resistor connected internally between each logic pin (EN, T/F, TX, SEL) and GND.

**Note 10:** Headroom Voltage ( $V_{HR}$ ) is the voltage across the current sinks ( $V_{Dx}$ ) at which the current falls to 95% of the nominal programmed current.  $V_{HR}$  is measured from  $V_{Dx}$  to GND. If the headroom voltage requirement is not met, LED current regulation will be compromised.

**Note 11:**  $I_{Dx}/I_{SETx}$  Ratio was tested with the Charge Pump in a gain of 1x.

## Block Diagram

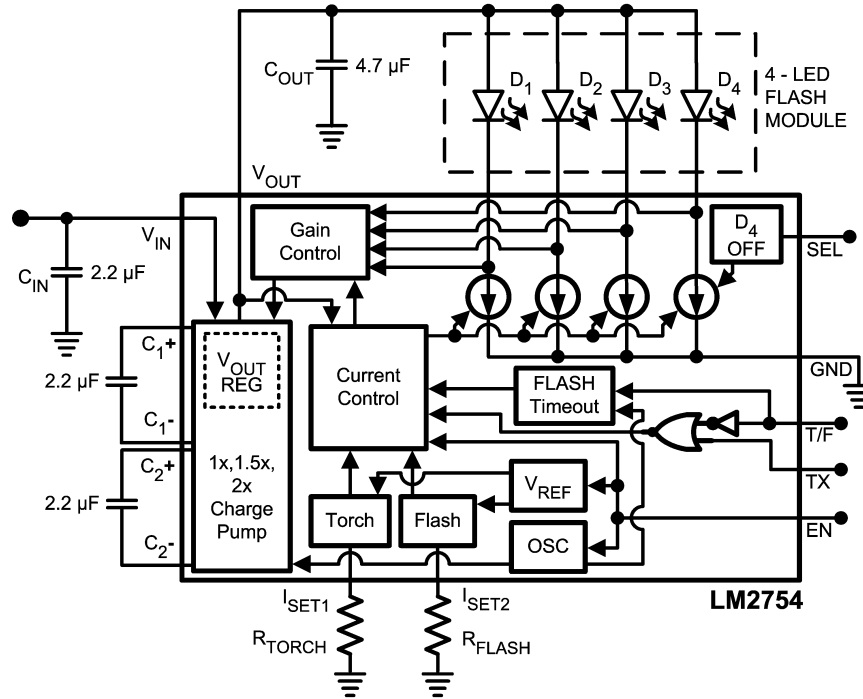

20202803

**Typical Performance Characteristics** Unless otherwise specified:  $T_A = 25^\circ\text{C}$ ,  $V_{Dx} = 1\text{V}$ ,  $V_{(IN, INSW)} = 3.6\text{V}$ ,  $V_{EN} = V_{IN}$ ,  $V_{T/F} = V_{TX} = V_{SEL} = 0\text{V}$ ,  $C_{IN} = C_1 = C_2 = 2.2\mu\text{F}$ ,  $C_{OUT} = 4.7\mu\text{F}$ . Capacitors are low-ESR multi-layer ceramic capacitors (MLCC's).

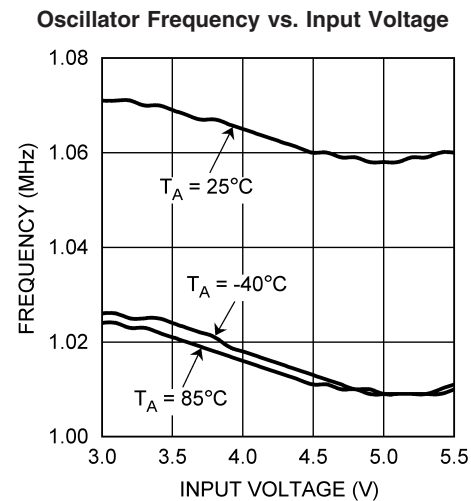
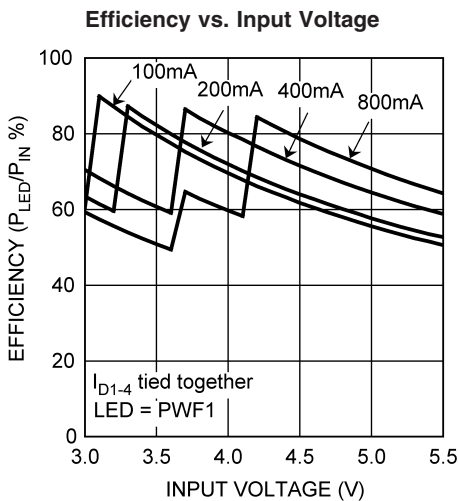
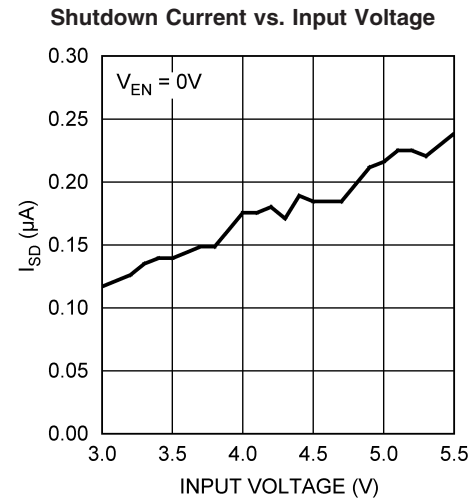
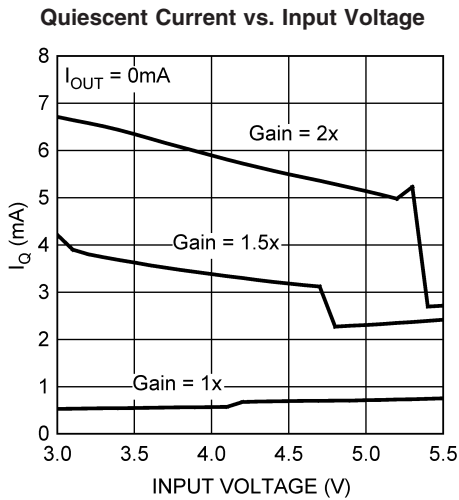
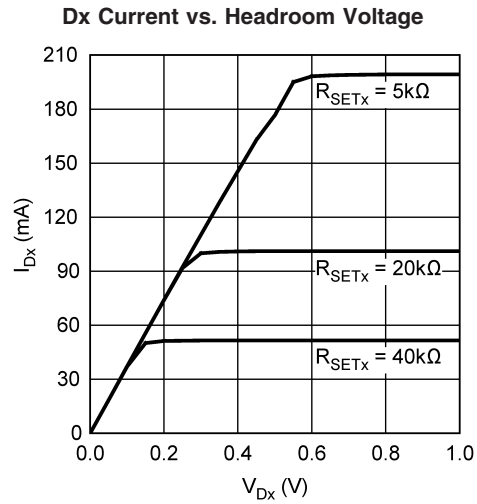
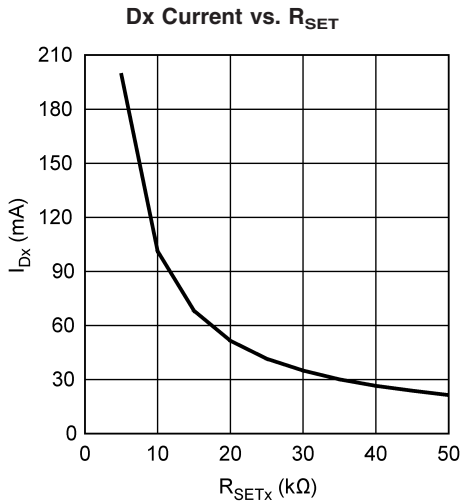

**Typical Performance Characteristics** Unless otherwise specified:  $T_A = 25^\circ\text{C}$ ,  $V_{Dx} = 1\text{V}$ ,  $V_{(IN, INSW)} = 3.6\text{V}$ ,  $V_{EN} = V_{IN}$ ,  $V_{T/F} = V_{TX} = V_{SEL} = 0\text{V}$ ,  $C_{IN} = C_1 = C_2 = 2.2\mu\text{F}$ ,  $C_{OUT} = 4.7\mu\text{F}$ . Capacitors are low-ESR multi-layer ceramic capacitors (MLCC's). (Continued)

**Flash Mode with TX Pulse**

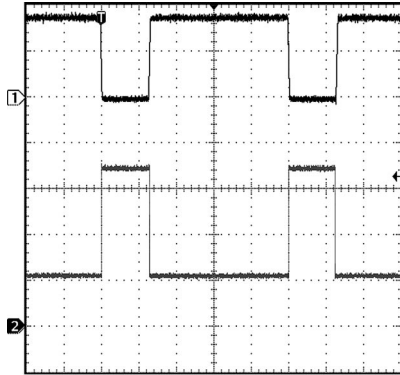

20202810

$V_{IN} = 3.6\text{V}$ , Load = 700mA (Flash), LED = PWF1  
 CH1 (TOP):  $V_{TX}$ ; Scale: 1V/Div, DC Coupled  
 CH2 (BOTTOM):  $I_{LED}$ ; Scale: 200mA/Div  
 Time scale: 1ms/Div

**Torch to Flash Mode**

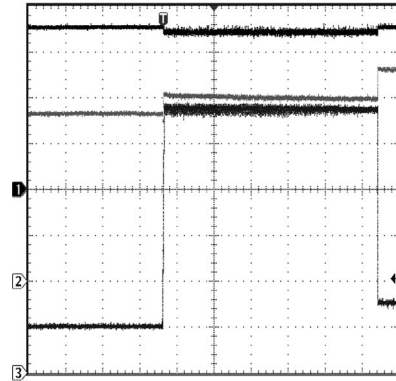

20202811

$V_{IN} = 3.6\text{V}$ , Load = 200mA/800mA (Torch/Flash), LED = PWF1  
 CH1 (TOP):  $V_{IN}$ ; Scale: 1V/Div, DC Coupled  
 CH2 (MIDDLE):  $V_{OUT}$ ; Scale: 1V/Div, DC Coupled  
 CH3 (BOTTOM):  $I_{IN}$ ; Scale: 200mA/Div  
 Time scale: 100ms/Div

**Torch to Flash Mode  
Rising Edge**

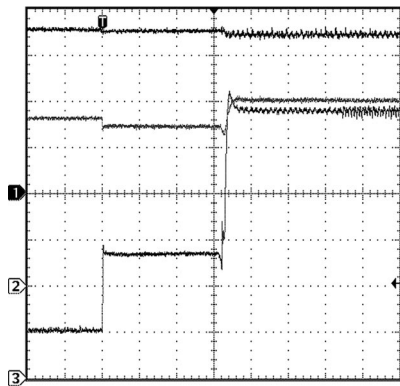

20202812

$V_{IN} = 3.6\text{V}$ , Load = 200mA/800mA (Torch/Flash), LED = PWF1  
 CH1 (TOP):  $V_{IN}$ ; Scale: 1V/Div, DC Coupled  
 CH2 (MIDDLE):  $V_{OUT}$ ; Scale: 1V/Div, DC Coupled  
 CH3 (BOTTOM):  $I_{IN}$ ; Scale: 200mA/Div  
 Time scale: 400µs/Div

**Flash to Torch Mode  
Falling Edge**

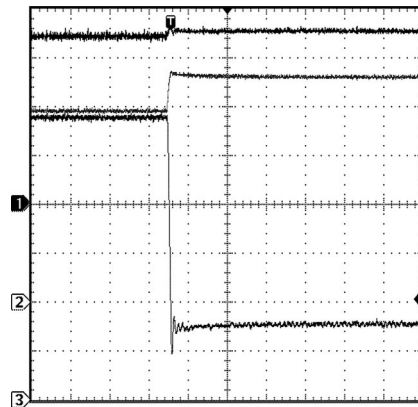

20202813

$V_{IN} = 3.6\text{V}$ , Load = 800mA/200mA (Flash/Torch), LED = PWF1  
 CH1 (TOP):  $V_{IN}$ ; Scale: 1V/Div, DC Coupled  
 CH2 (MIDDLE):  $V_{OUT}$ ; Scale: 1V/Div, DC Coupled  
 CH3 (BOTTOM):  $I_{IN}$ ; Scale: 200mA/Div  
 Time scale: 100µs/Div

**Typical Performance Characteristics** Unless otherwise specified:  $T_A = 25^\circ\text{C}$ ,  $V_{\text{Dx}} = 1\text{V}$ ,  $V_{(\text{IN}, \text{INSW})} = 3.6\text{V}$ ,  $V_{\text{EN}} = V_{\text{IN}}$ ,  $V_{\text{T/F}} = V_{\text{TX}} = V_{\text{SEL}} = 0\text{V}$ ,  $C_{\text{IN}} = C_1 = C_2 = 2.2\mu\text{F}$ ,  $C_{\text{OUT}} = 4.7\mu\text{F}$ . Capacitors are low-ESR multi-layer ceramic capacitors (MLCC's). (Continued)

#### Battery Ripple, Gain = 1.5x

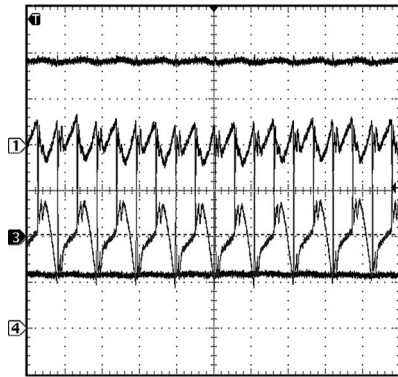

20202814

$V_{\text{IN}} = \text{Li-Ion Battery at } 3.7\text{V}$ , Load = 400mA, LED = PWF1  
 CH1 (MID-TOP):  $V_{\text{OUT}}$ ; Scale: 20mV/Div, AC Coupled  
 CH2 (MID-BOTTOM):  $V_{\text{IN}}$ ; Scale: 50mV/Div, AC Coupled  
 CH3 (TOP):  $V_{\text{IN}}$ ; Scale: 1V/Div, DC Coupled  
 CH4 (BOTTOM):  $I_{\text{IN}}$ ; Scale: 500mA/Div  
 Time scale: 1µs/Div

#### Battery Ripple, Gain = 2x

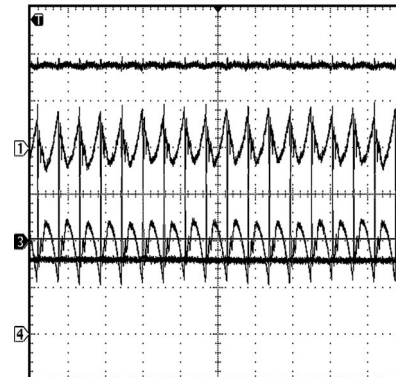

20202815

$V_{\text{IN}} = \text{Li-Ion Battery at } 3.7\text{V}$ , Load = 400mA, LED = PWF1  
 CH1 (MID-TOP):  $V_{\text{OUT}}$ ; Scale: 20mV/Div, AC Coupled  
 CH2 (MID-BOTTOM):  $V_{\text{IN}}$ ; Scale: 50mV/Div, AC Coupled  
 CH3 (TOP):  $V_{\text{IN}}$ ; Scale: 1V/Div, DC Coupled  
 CH4 (BOTTOM):  $I_{\text{IN}}$ ; Scale: 500mA/Div  
 Time scale: 1µs/Div

#### Startup and Shutdown Response Torch Mode (400mA)

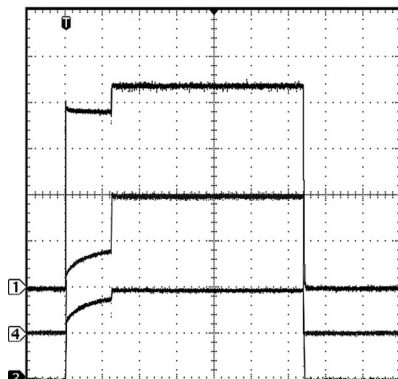

20202816

$V_{\text{IN}} = 3.6\text{V}$ , Load = 400mA, LED = PWF1  
 CH1 (TOP):  $V_{\text{OUT}}$ ; Scale: 1V/Div, DC Coupled  
 CH4 (MIDDLE):  $I_{\text{IN}}$ ; Scale: 200mA/Div  
 CH3 (BOTTOM):  $I_{\text{OUT}}$ ; Scale: 200mA/Div  
 Time scale: 100ms/Div

## Application Information

### CIRCUIT DESCRIPTION

The LM2754 is an adaptive 1x/1.5x/2x CMOS charge pump, optimized for driving Flash LEDs in camera phone and other portable applications. It provides four constant current inputs, each capable of sinking up to 200mA for Flash mode, and 100mA for Torch mode.

Each LED is driven from  $V_{OUT}$  and connected to one of the four current sinks. LED drive current for Torch mode is programmed by connecting a resistor,  $R_{SET1}$ , to the current set pin,  $I_{SET1}$ . LED drive current for Flash mode is set by connecting a resistor,  $R_{SET2}$ , to the current set pin,  $I_{SET2}$ . Torch mode is enabled by the EN pin, and the transition from Torch to Flash mode is controlled by the T/F pin. This device also has an option to disable the  $D_4$  current sink via the SEL pin, for Flash LED modules with only 3 LEDs.

To prevent high battery load during a simultaneous RF PA transmission pulse and Flash condition, this device has a Flash interrupt pin (TX) to reduce the LED current to the Torch mode level for the duration of the RF PA transmission pulse.

### CHARGE PUMP

The input to the 1x/1.5x/2x charge pump is connected to the  $V_{IN}$  pin, and the loosely regulated output of the charge pump is connected to the  $V_{OUT}$  pin. The device's loosely-regulated charge pump has both open loop and closed loop modes of operation. Under no-load conditions, open loop operation occurs when  $V_{OUT}$  is equal to the product of the input voltage and the charge pump gain, and is less than the nominal output regulation voltage. Over the recommended input voltage range of 3.0V to 5.5V, unloaded open loop operation will only occur in 1x and 1.5x gains. When the LM2754 is in closed loop operation with no-load, the voltage at  $V_{OUT}$  is loosely regulated to 4.7V (typ.) for the 1x and 1.5x gains, and 5.1V (typ.) for the 2x gain. When under load, the voltage at  $V_{OUT}$  can be less than the target regulation voltage while the charge pump is still in closed loop operation. This is due to the load regulation topology of the LM2754.

The charge pump gain transitions are actively selected to maintain regulation based on LED forward voltage and load requirements. The charge pump only transitions to higher gains, from 1x to 1.5x and 1.5x to 2x. Each transition from one gain to the next takes 125ms (typ.) for Torch mode and 2ms (typ.) for Flash mode. Once the charge pump transitions to a higher gain, it will remain at that gain for as long as the device remains enabled. Shutting down and then re-enabling the device resets the gain mode to the minimum gain required to maintain the load.

### SOFT START

The LM2754 contains internal soft-start circuitry to limit in-rush currents when the part is enabled. Soft start is implemented internally with a controlled turn-on of the internal voltage reference.

### CURRENT LIMIT PROTECTION

The LM2754 charge pump contains current limit protection circuitry that protects the device during  $V_{OUT}$  fault conditions where excessive current is drawn. Output current is limited to 1.2A (typ.).

### LOGIC CONTROL PINS

There are 4 logic control pins for the LM2754. All pins are active-High logic (High = Function ON). There is an internal pull-down resistor (500k $\Omega$  typ.) connected between each logic pin and GND. The operating modes for the part function according to the Table below:

EN	T/F	TX	SEL	Mode
0	X	X	X	Part in Shutdown
1	0	X	0	Part Enabled, Current set by $R_{SET1}$ , $D_{1-4}$ Active
1	0	X	1	Part Enabled, Current set by $R_{SET1}$ , $D_{1-3}$ Active, $D_4$ Disabled
1	1	0	0	Part Enabled, Current set by $R_{SET2}$ , $D_{1-4}$ Active
1	1	0	1	Part Enabled, Current set by $R_{SET2}$ , $D_{1-3}$ Active, $D_4$ Disabled
1	1	1	0	Part Enabled, Current set by $R_{SET1}$ , TX signal from RF PA, $D_{1-4}$ Active
1	1	1	1	Part Enabled, Current set by $R_{SET1}$ , TX signal from RF PA, $D_{1-3}$ Active, $D_4$ Disabled

### EN PIN (TORCH)

The EN pin is the master enable pin for the part. When the voltage on this pin is Low (<0.4V), the part is in shutdown mode. In this mode, all internal circuitry is OFF,  $V_{OUT}$  is disconnected from the  $V_{IN}$ , and the part consumes very little supply current (<1 $\mu$ A typ.). When the voltage on the EN pin is High (>1.2V), the part will activate the charge pump and regulate the output voltage to its nominal value. When the output voltage reaches its regulation level, the current sinks will turn on and sink the current programmed by  $R_{SET1}$  (assuming the logic on T/F is Low). Enabling the device is also referred to as Torch Mode. For correct start-up sequencing, power must be applied to  $V_{IN}$  before a High logic signal is applied to the EN pin.

### T/F PIN (FLASH) AND FLASH TIMEOUT

A logic Low (<0.4V) signal on the T/F pin disables the Flash mode, defaulting the current through the LEDs to the Torch level programmed by  $R_{SET1}$ . Applying a logic High (>1.2V) signal to T/F places the device in Flash mode, with the LED current set by  $R_{SET2}$ .

Flash Timeout Protection Circuitry disables the current sinks when the signal on T/F is held high for more than 1 second (typ). This prevents the device from self-heating due to the high power dissipation during Flash conditions. During the timeout condition, voltage will still be present on  $V_{OUT}$  but the current sinks will be shut off, resulting in no current through the Flash LEDs. When the device goes into a timeout condition, placing a logic Low signal on EN will reset the timeout and a subsequent logic High signal on EN will return the device to normal operation. Flash timeout is not active during TX mode.

### TX PIN

The TX pin on the LM2754 disables the Flash operation during a RF PA transmission pulse, and sets the LED current to the Torch level programmed by  $R_{SET1}$  for the duration of that pulse. At the end of each transmission interrupt pulse



## Application Information (Continued)

signal on the TX pin, the LED current level returns to the Flash current level set by  $R_{SET2}$ . The TX pin responds to the typical logic High (>1.2V) and logic Low (<0.4V) signal levels. Flash Timeout is not active during the TX mode operation.

### SEL PIN

Connecting the SEL pin to a logic Low (<0.4V) signal places the device in normal operation, with all 4 current sinks active. To accommodate Flash LED modules with only 3 LEDs, place a logic High (>1.2V) signal on the SEL pin to disable the current sink  $D_4$ . If only 3 current sinks are used, the 200mA per current sink recommendation still applies, and the maximum Flash current will be 600mA. Connect  $D_4$  to  $V_{OUT}$  when the logic in the SEL pin is High. Optional use of the SEL pin is to reduce the LED current used for Torch or Flash by 25% for high battery load conditions.

### SETTING LED CURRENTS

The current through the LEDs connected to  $D_{1-4}$  can be set simply by connecting an appropriately sized resistor ( $R_{SETx}$ ) between the  $I_{SET1}$  pin of the LM2754 and GND for Torch mode and the  $I_{SET2}$  pin and GND for Flash Mode. The LED currents are proportional to the current that flows out of the  $I_{SETx}$  pin and are a factor of approximately 800 times greater than the  $I_{SETx}$  current. The feedback loop of an internal amplifier sets the voltage of the  $I_{SET}$  pin to 1.25V (typ.). The statements above are simplified in the equations below:

$$I_{Dx} = 800 \times (V_{SET} / R_{SET})$$

$$R_{SET} = 800 \times (1.25V / I_{Dx})$$

The maximum recommended current through each current sink is 100mA during Torch mode and 200mA during Flash mode. Maximum recommended total Flash current with all 4 current sinks used is 800mA (max 200mA per current sink). Using the part in conditions where the junction temperature might rise above the rated maximum requires that the operating ranges and/or conditions be de-rated. The printed circuit board also must be carefully laid out to account for high thermal dissipation in the part.

### PARALLEL DX OUTPUTS FOR INCREASED CURRENT DRIVE

Outputs  $D_{1-4}$  may be connected together to drive a one or two LEDs at higher currents. In applications using a single LED, all four parallel current sinks of equal value drive the single LED. For this type of configuration, the LED current should be programmed so that the current through each of the outputs is 25% of the total desired LED current. For example, if 200mA is the desired drive current for the single LED,  $R_{SET}$  should be selected such that the current through each of the current sink inputs is 50mA. Similarly, if two LEDs are to be driven by pairing up the  $D_{1-4}$  inputs (i.e.  $D_{1-2}$ ,  $D_{3-4}$ ),  $R_{SET}$  should be selected such that the current through each current sink input is 50% of the desired LED current.

Connecting the outputs in parallel does not affect internal operation of the LM2754 and has no impact on the Electrical Characteristics and limits previously presented. The available diode output current, maximum diode voltage, and all other specifications provided in the Electrical Characteristics table apply to this parallel output configuration, just as they do to the standard 4-LED application circuit.

Maximum recommended LED current for any configuration is 200mA per current sink, and 800mA total. For situations where only 3 current sinks will be used for the application, see the **SEL PIN** operation section.

### CAPACITOR SELECTION

The LM2754 requires 4 external capacitors for proper operation. Surface-mount multi-layer ceramic capacitors are recommended. These capacitors are small, inexpensive and have very low equivalent series resistance (ESR <20mΩ typ.). Tantalum capacitors, OS-CON capacitors, and aluminum electrolytic capacitors are not recommended for use with the LM2754 due to their high ESR, as compared to ceramic capacitors.

For most applications, ceramic capacitors with X7R or X5R temperature characteristic are preferred for use with the LM2754. These capacitors have tight capacitance tolerance (as good as ±10%) and hold their value over temperature (X7R: ±15% over -55°C to 125°C; X5R: ±15% over -55°C to 85°C).

Capacitors with Y5V or Z5U temperature characteristic are generally not recommended for use with the LM2754. Capacitors with these temperature characteristics typically have wide capacitance tolerance (+80%, -20%) and vary significantly over temperature (Y5V: +22%, -82% over -30°C to +85°C range; Z5U: +22%, -56% over +10°C to +85°C range). Under some conditions, a nominal 1μF Y5V or Z5U capacitor could have a capacitance of only 0.1μF. Such detrimental deviation is likely to cause Y5V and Z5U capacitors to fail to meet the minimum capacitance requirements of the LM2754.

The voltage rating of the output capacitor should be 10V or more. For example, a 10V 0603 4.7μF output capacitor (TDK C1608X5R1A475) is acceptable for use with the LM2754, as long as the capacitance on the output does not fall below a minimum of 3μF in the intended application. All other capacitors should have a voltage rating at or above the maximum input voltage of the application and should have a minimum capacitance of 1μF.

### POWER EFFICIENCY

Efficiency of LED drivers is commonly taken to be the ratio of power consumed by the LEDs ( $P_{LED}$ ) to the power drawn at the input of the part ( $P_{IN}$ ). With a 1x/1.5x/2x charge pump, the input current is equal to the charge pump gain times the output current (total LED current). The efficiency of the LM2754 can be predicted as follows:

$$P_{LED} = N \times V_{LED} \times I_{LED}$$

$$P_{IN} = V_{IN} \times I_{IN}$$

$$P_{IN} = V_{IN} \times (\text{Gain} \times N \times I_{LED} + I_Q)$$

$$E = (P_{LED} \div P_{IN})$$

For a simple approximation, the current consumed by internal circuitry ( $I_Q$ ) can be neglected, and the resulting efficiency will become:

$$E = V_{LED} \div (V_{IN} \times \text{Gain})$$

Neglecting  $I_Q$  will result in a slightly higher efficiency prediction, but this impact will be negligible due to the value of  $I_Q$  being very low compared to the typical Torch and Flash current levels (100-800mA). It is also worth noting that efficiency as defined here is in part dependent on LED voltage. Variation in LED voltage does not affect power consumed by the circuit and typically does not relate to the brightness of the LED. For an advanced analysis, it is recommended that power consumed by the circuit ( $V_{IN} \times I_{IN}$ ) be evaluated rather than power efficiency.

## Application Information (Continued)

### THERMAL PROTECTION

Internal thermal protection circuitry disables the LM2754 when the junction temperature exceeds 150°C (typ.). This feature protects the device from being damaged by high die temperatures that might otherwise result from excessive power dissipation. The device will recover and operate normally when the junction temperature falls below 120°C (typ.). It is important that the board layout provide good thermal conduction to keep the junction temperature within the specified operating ratings.

### POWER DISSIPATION

The power dissipation ( $P_{\text{DISSIPATION}}$ ) and junction temperature ( $T_J$ ) can be approximated with the equations below.  $P_{\text{IN}}$  is the power generated by the 1x/1.5x/2x charge pump,  $P_{\text{LED}}$  is the power consumed by the LEDs,  $T_A$  is the ambient temperature, and  $\theta_{JA}$  is the junction-to-ambient thermal resistance for the LLP-24 package.  $V_{\text{IN}}$  is the input voltage to the LM2754,  $V_{\text{LED}}$  is the nominal LED forward voltage, and  $I_{\text{LED}}$  is the programmed LED current.

$$P_{\text{DISSIPATION}} = P_{\text{IN}} - P_{\text{LED}}$$

$$= [\text{Gain} \times V_{\text{IN}} \times (4 \times I_{\text{LED}})] - (V_{\text{LED}} \times 4 \times I_{\text{LED}})$$

$$T_J = T_A + (P_{\text{DISSIPATION}} \times \theta_{JA})$$

The junction temperature rating takes precedence over the ambient temperature rating. The LM2754 may be operated outside the ambient temperature rating, so long as the junction temperature of the device does not exceed the maximum operating rating of 125°C. The maximum ambient temperature rating must be derated in applications where high power dissipation and/or poor thermal resistance causes the junction temperature to exceed 125°C.

### PCB Layout Considerations

The LLP is a leadframe based Chip Scale Package (CSP) with very good thermal properties. This package has an exposed DAP (die attach pad) at the center of the package measuring 2.6mm x 2.6mm. The main advantage of this exposed DAP is to offer lower thermal resistance when it is soldered to the thermal land on the PCB. For PCB layout, National highly recommends a 1:1 ratio between the package and the PCB thermal land. To further enhance thermal conductivity, the PCB thermal land may include vias to a ground plane. For more detailed instructions on mounting LLP packages, please refer to National Semiconductor Application Note AN-1187.

**Physical Dimensions** inches (millimeters) unless otherwise noted

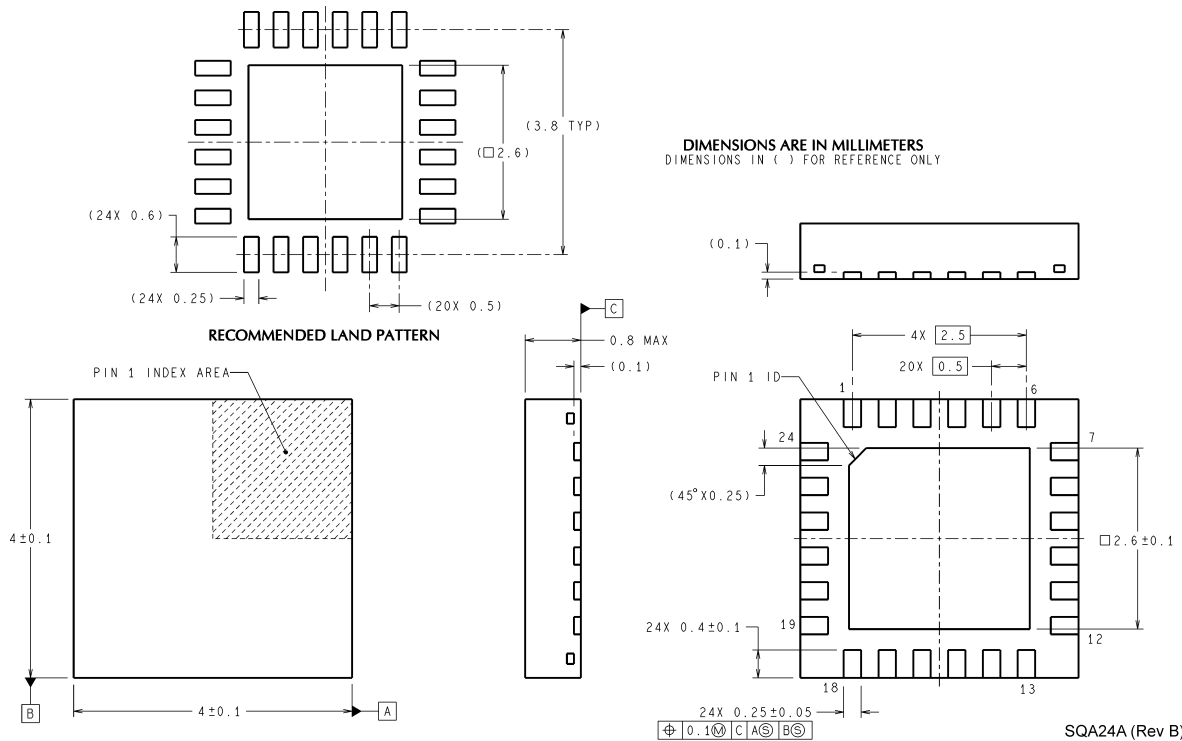

**24-Pin LLP  
NS Package Number SQA24A**

National does not assume any responsibility for use of any circuitry described, no circuit patent licenses are implied and National reserves the right at any time without notice to change said circuitry and specifications.  
For the most current product information visit us at [www.national.com](http://www.national.com).

**LIFE SUPPORT POLICY**

NATIONAL'S PRODUCTS ARE NOT AUTHORIZED FOR USE AS CRITICAL COMPONENTS IN LIFE SUPPORT DEVICES OR SYSTEMS WITHOUT THE EXPRESS WRITTEN APPROVAL OF THE PRESIDENT AND GENERAL COUNSEL OF NATIONAL SEMICONDUCTOR CORPORATION. As used herein:

1. Life support devices or systems are devices or systems which, (a) are intended for surgical implant into the body, or (b) support or sustain life, and whose failure to perform when properly used in accordance with instructions for use provided in the labeling, can be reasonably expected to result in a significant injury to the user.
2. A critical component is any component of a life support device or system whose failure to perform can be reasonably expected to cause the failure of the life support device or system, or to affect its safety or effectiveness.

**BANNED SUBSTANCE COMPLIANCE**

National Semiconductor follows the provisions of the Product Stewardship Guide for Customers (CSP-9-111C2) and Banned Substances and Materials of Interest Specification (CSP-9-111S2) for regulatory environmental compliance. Details may be found at: [www.national.com/quality/green](http://www.national.com/quality/green).

Lead free products are RoHS compliant.



**National Semiconductor**  
Americas Customer  
Support Center  
Email: [new.feedback@nsc.com](mailto:new.feedback@nsc.com)  
Tel: 1-800-272-9959

**National Semiconductor**  
Europe Customer Support Center  
Fax: +49 (0) 180-530 85 86  
Email: [europe.support@nsc.com](mailto:europe.support@nsc.com)  
Deutsch Tel: +49 (0) 69 9508 6208  
English Tel: +44 (0) 870 24 0 2171  
Français Tel: +33 (0) 1 41 91 8790

**National Semiconductor**  
Asia Pacific Customer  
Support Center  
Email: [ap.support@nsc.com](mailto:ap.support@nsc.com)

**National Semiconductor**  
Japan Customer Support Center  
Fax: 81-3-5639-7507  
Email: [jpn.feedback@nsc.com](mailto:jpn.feedback@nsc.com)  
Tel: 81-3-5639-7560