

The LM2931 positive voltage regulator features a very low quiescent current of 1mA or less when supplying 10mA loads. This unique characteristic and the extremely low in-put-output differential required for proper regulation (0.2V for output currents of 10mA) make the LM2931 the ideal regulator for standby power systems. Applications include memory standby circuits, CMOS and other low power processor power supplies as well as systems demanding as much as 100mA of output current.

such as a load dump (60V) when the input voltage to the regulator can momentarily exceed the specified maximum operating voltage, the regulator will automatically shut down to protect both internal circuits and the load. The LM2931 can not be harmed by temporary mirror-image insertion. Familiar regulator features such as short circuit and thermal overload protection are also provided.

Fixed output of 5V is available in the plastic the popular TO-92 package.

Designed originally for automotive applications, the LM2931 and all regulated circuitry are protected from reverse battery installations or 2 battery jumps. During line transients,

FEATURES

- Very low quiescent current
- Output current in excess of 100mA
- Input-Output differential less than 0.6V
- Reverse battery protection
- 60V load dump protection
- -40V reverse transient protection
- Short circuit protection
- Internal thermal overload protection
- Mirror-image insertion protection
- Available in plastic TO-92
- Available as adjustable with TTL compatible switch
- 100% electrical burn-in in thermal limit

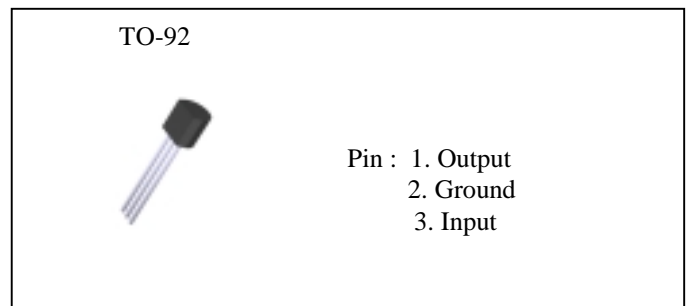

OUTPUT VOLTAGE OPTIONS

DEVICE	V _{OUT} VOLTS	PACKAGE
LM2931CT-5.0	5V	TO-92
LM2931ACT-5.0	5V	TO-92

SCHEMATIC AND CONNECTION DIAGRAMS

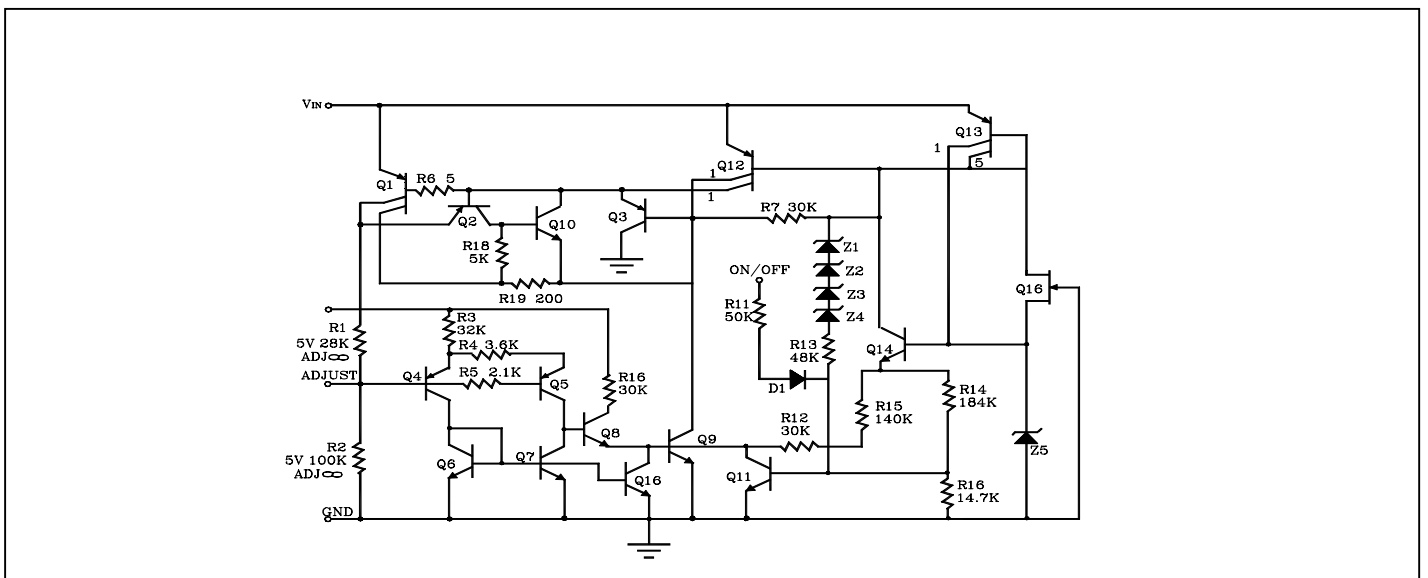



LM2931-5.0

Low Dropout Regulator

ABSOLUTE MAXIMUM RATINGS

Absolute Maximum Ratings

Input Voltage	26V	Internal Power Dissipation(Note 1)	Internally Limited
Operating Range		Operating Temperature Range	0°C to +70
Overshoot Protection		Maximum Junction Temperature	125°C
		Storage Temperature Range	-40°C to +150°C
PJ2931	50V	Lead Temp.(Soldering, 10 seconds)	210°C

ELECTRICAL CHARACTERISTICS (V_{IN}=14V, I_O=10mA, T_J=25°C (Note 1), C₂=100 μ F (unless otherwise specified))

Parameter	Conditions	LM 2931A-5.0			LM 2931-5.0			Units Limit
		Typ	Test Limit (Note 2)	Design limit (Note 3)	Typ	Test Limit (Note 2)	Design limit (Note 3)	
Output Voltage		5	5.19 4.81		5	5.25 4.75		V _{MAX} V _{MIN}
	6.0V V _{IN} 26V, I _O 100mA -40°C T _J 125°C			5.25 4.75			5.5 4.5	V _{MAX} V _{MIN}
Line Regulation	9V V _{IN} 16V	2	10		2	10		mV _{MAX}
	6V V _{IN} 26V	4	30		4	30		mV _{MAX}
Load Regulation	5mA I _O 100mA	14	50		14	50		mV _{MAX}
Output Impedance	100mA _{DC} and 10mA _{Arms} , 100Hz-10KHz	200		600	200			mΩ _{MAX}
Quiescent Current	I _O 10mA, 6V V _{IN} 26V -40°C T _J 125°C	0.4	1.0	1.0	0.4	1.0	1.0	mA _{MAX} mA _{MIN}
	I _O =100mA, V _{IN} =14V, T _J =25°C	15		30 5	15			mA _{MAX} mA _{MIN}
Output Noise Voltage	10Hz-100KHz, C _{OUT} =100 μ F	500		1000	500			μ V _{rmsMAX}
Long Term Stability		20		50	20			mV /1000hr
Ripple Rejection	f _o =120Hz	80		55	80			dB _{MIN}
Dropout Voltage	I _O =10mA	0.05	0.2		0.05	0.2		V _{MAX}
	I _O =100mA	0.3	0.6		0.3	0.6		V _{MAX}
Maximum Operational Input Voltage		33			33			V _{MAX}
			26			26		V _{MIN}
Maximum Line Transient	R _L =500Ω, V _o 5.5V, 100ms	70	60		70	50		V _{MIN}
Reverse Polarity Input Voltage, DC	V _o -0.3V, R _L =500Ω	-30	-15		-30	-15		V _{MIN}
Reverse Polarity Input Voltage, Transient	1% Duty Cycle, 100ms, R _L =500Ω	-80	-50		-80	-50		V _{MIN}

Note 1: To ensure constant junction temperature, low duty cycle pulse testing is used.

Note 2: Guaranteed and 100% production tested.

Note 3: Guaranteed (but not 100% production tested) over the operating temperature and input current ranges. These limits are not used to calculate outgoing quality levels.

Note 4: Thermal resistance junction-to-case (θ_{jc}) is 3°C/W; case-to-ambient is 50°C/W.



LM2931-5.0

Low Dropout Regulator

ELECTRICAL CHARACTERISTICS FOR ADJUSTABLE PJ2931CT

$V_{IN}=14V, V_{OUT}=3V, I_O=10\text{ mA}, T_J=25^\circ\text{C}$ (Note 1), $R_1=27K, C_2=100\mu\text{F}$ (unless otherwise specified)

Parameter	Conditions	Typ	Test Limit	Design limit	Units Limit
Reference Voltage		1.20	1.26 1.14		V_{MAX} V_{MIN}
	$I_O = 100\text{mA}, -40^\circ\text{C} \leq T_J \leq 125^\circ\text{C},$ $R_1=27K$ Measured from V_{OUT} to Adjust Pin			1.32 1.08	V_{MAX} V_{MIN}
Output Voltage Range			24 3		V_{MAX} V_{MIN}
Line Regulation	$V_{OUT}+0.6V \leq V_{IN} \leq 26V$	0.2	1.5		mV/V_{MAX}
Load Regulation	$5\text{mA} \leq I_O \leq 100\text{mA}$	0.3	1		%MAX
Output Impedance	100mA_{DC} and 10mA_{rms} 100Hz-10KHz	40			$\text{m}\Omega/V$
Quiescent Current	$I_O=10\text{mA}$	0.4	1		mA_{MAX}
	$I_O=100\text{ mA}$	15			mA
	During Shutdown $R_L=500\Omega$	0.8	1		mA_{MAX}
Output Noise Voltage	10Hz-100KHz	100			$\mu\text{V}_{rms}/V$
Long Term Stability		0.4			%/1000hr
Ripple Rejection	$f_o=120\text{Hz}$	0.02			%/V
Dropout Voltage	$I_O = 10\text{ mA}$	0.05	0.2		V_{MAX}
	$I_O=100\text{ mA}$	0.3	0.6		V_{MAX}
Maximum Operational Input Voltage		33	26		V_{MIN}
Maximum Line Transient	$I_O=10\text{ mA}, \text{Reference Voltage} = 1.5V$	70	60		V_{MIN}
Reverse Polarity Input Voltage, DC	$V_O = -0.3V, R_L=500\Omega$	-30	-15		V_{MIN}
Reverse Polanty Input Voltage Transient	1% Duty Cycle, $T = 100\text{ms}, R_L=500\Omega$	-80	-50		V_{MIN}
On/Off Threshold Voltage	$V_O=3V$	2.0	1.2		V_{MAX}
		2.2	3.25		V_{MIN}
On/Off Threshold Current		20	50		μA_{MAX}



LM2931-5.0

Low Dropout Regulator

Typical Performance Characteristics

Dropout Voltage

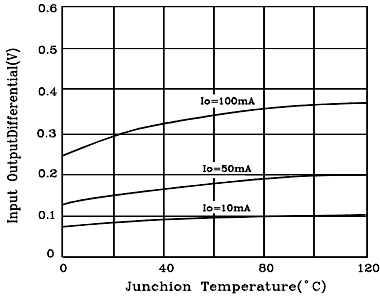

Dropout Voltage

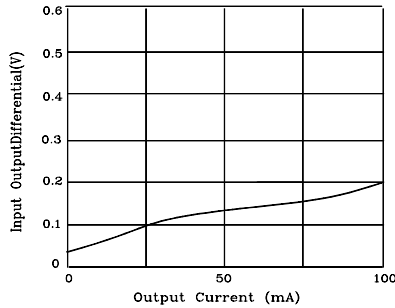

Low Voltage Behavior

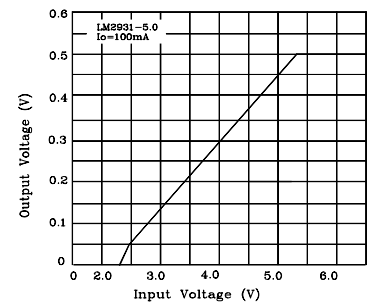

Output at Voltage Extremes

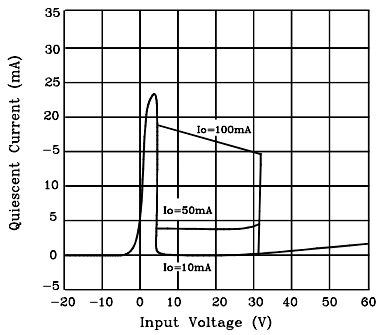

Line Transient Response

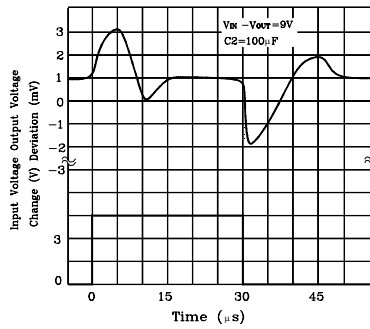

Load Transient Response

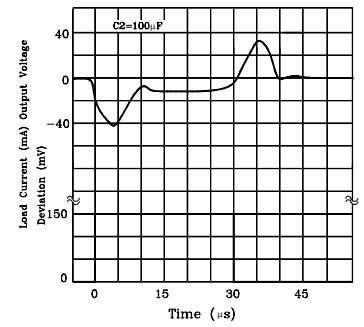

Peak Output Current

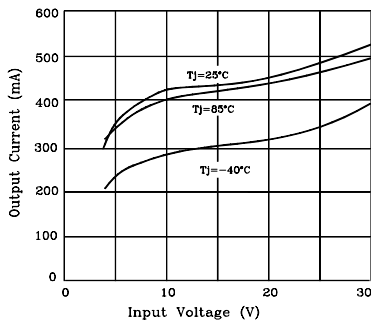

Quiescent Current

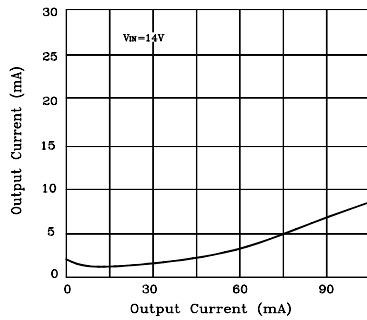

Quiescent Current

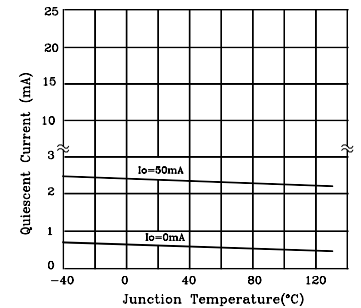

Quiescent Current

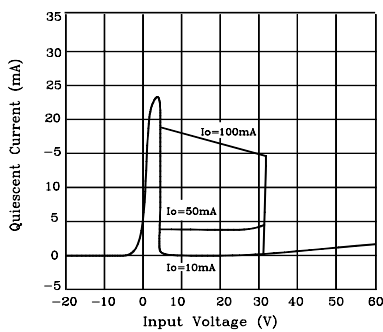

Ripple Rejection

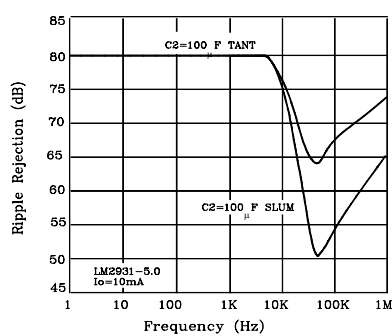

Ripple Rejection

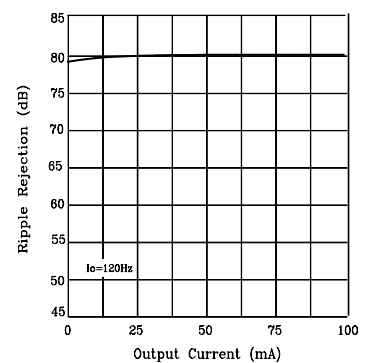



LM2931-5.0

Low Dropout Regulator

Typical Performance Characteristics(Continued)

Output Impedance

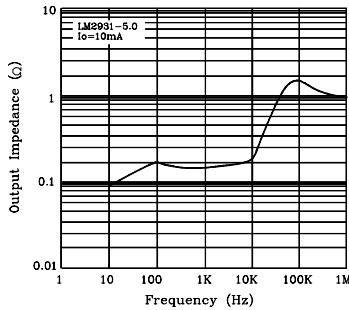

Operation During Load Dump

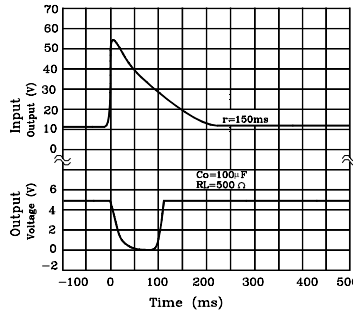

Reference Voltage

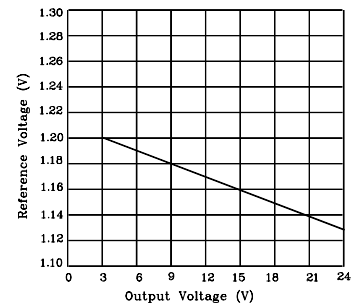

On/Off Threshold

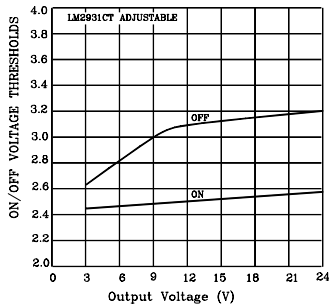

Maximum Power Dissipation (TO-220)

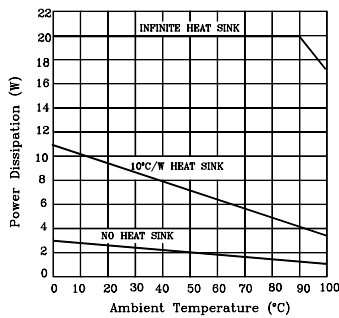

Maximum Power Dissipation (TO-92)

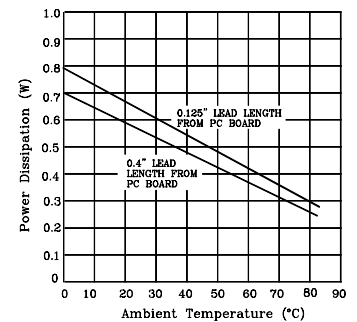

Typical Applications

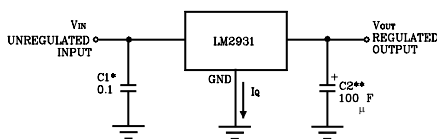

*Required if regulator is located far from power supply filter.

LM2931 ADJUSTABLE

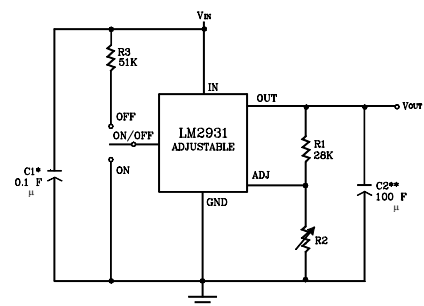

*Required if regulator is located far from power supply filter.

$$V_{OUT} = \text{Reference Voltage} \times \frac{R1+R2}{R1}$$

Note: Using 28K for R1 will automatically compensate for errors in V_{OUT} due to the input bias current of the ADJ pin (approximately $1\mu A$)

** C_{OUT} must be at least $22\mu F$ to maintain stability. May be increased without bound to maintain regulation during transients. Locate as close as possible to the regulator. This capacitor must be rated over the operating temperature range as the regulator. The equivalent series resistance (ESR) of this capacitor should be less than 1Ω over the operating temperature range.



Application Hints

One of the distinguishing factors of the LM2931 series regulators is the requirement of an output capacitor for device stability. The value required varies greatly depending upon the application circuit and other factors. Thus some comments on the characteristics of both capacitors and the regulator are in order.

High frequency characteristics of electrolytic capacitors depend greatly on the type and even the manufacturer. As a result, a value of capacitance that works well with the LM2931 for one brand or type may not necessarily be sufficient with an electrolytic of different origin. Sometimes actual bench testing, as described later, will be the only means to determine the proper capacitor and value. Experience has shown that, as a rule of thumb, the more expensive and higher quality electrolytics generally allow a smaller value for regulator stability. As an example, while a high-quality 100 μ F aluminum electrolytic covers all general application circuits, similar stability can be obtained with a tantalum electrolytic of only 47 μ F. This factor of two can generally be applied to any special application circuit also.

Another critical characteristic of electrolytics is their performance over temperature. While the LM2931 is designed to operate to -40 $^{\circ}$ C, the same is not always true with all electrolytics (hot is generally not a problem). The electrolyte in many aluminum types will freeze around -30 $^{\circ}$ C, reducing their effective value to zero. Since the capacitance is needed for regulator stability, the natural result is oscillation (and lots of it) at the regulator output. For all application circuits where cold operation is necessary, the output capacitor must be rated to operate at the minimum temperature. By coincidence, worst-case stability for the LM2931 also occurs at minimum temperatures. As a result, in applications where the regulator junction temperature will never be less than 25 $^{\circ}$ C, the output capacitor can be reduced approximately by a factor of two over the value needed for the entire temperature range. To continue our example with the tantalum electrolytic, a value of only 22 μ F would probably thus suffice. For high-quality aluminum, 47 μ F would be adequate in such an application.

Another regulator characteristic that is noteworthy is that stability decreases with higher output currents. This sensible fact has important connotations. In many applications, the LM2931 is operated at only a few milliamps of output current or less. In such a circuit, the output capacitor can be further reduced in value. As a rough estimation, a circuit that is required to deliver a maximum of 10mA of output current from the regulator would need an output capacitor of only half the value compared to the same regulator required to deliver the full output current of 100mA. If the example of the tantalum capacitor in the circuit rated at 25 $^{\circ}$ C junction temperature and above were continued to include a maximum of 10 mA of output current, then the 22 μ F output capacitor could be reduced to only 10 μ F.

In the case of the LM2931CT adjustable regulator, the minimum

value of output capacitance is a function of the output voltage. As a general rule, the value decreases with higher output voltages, since internal loop gain is reduced.

At this point, the procedure for bench testing the minimum value of an output capacitor in a special application circuit should be clear. Since worst-case occurs at minimum operating temperatures and maximum operating currents, the entire circuit, including the electrolytic, should be cooled to the minimum temperature. The input voltage to the regulator should be maintained at 0.6V above the output to keep internal power dissipation and die heating to a minimum. Worst-case occurs just after input power is applied and before the die has had a chance to heat up. Once the minimum value of capacitance has been found for the brand and type of electrolytic in question, the value should be doubled for actual use to account for production variations both in the capacitor and the regulator. (All the values in this section and the remainder of the data sheet were determined in this fashion.)

Definition of Terms

Dropout Voltage: The input-output voltage differential at which the circuit ceases to regulate against further reduction in input voltage. Measured when the output voltage has dropped 100 mV from the nominal value obtained at 14V input, dropout voltage is dependent upon load current and junction temperature.

Input Voltage: The DC voltage applied to the input terminals with respect to ground.

Input-Output Differential: The voltage difference between the unregulated input voltage and the regulated output voltage for which the regulator will operate.

Line Regulation: The change in output voltage for a change in the input voltage. The measurement is made under conditions of low dissipation or by using pulse techniques such that the average chip temperature is not significantly affected.

Load Regulation: The change in output voltage for a change in load current at constant chip temperature.

Long Term Stability: Output voltage stability under accelerated life-test conditions after 1000 hours with maximum rated voltage and junction temperature.

Output Noise Voltage: The rms AC voltage at the output, with constant load and no input ripple, measured over a specified frequency range.

Quiescent Current: That part of the positive input current that does not contribute to the positive load current. The regulator ground lead current.

Ripple Rejection: The ratio of the peak-to-peak input ripple voltage to the peak-to-peak output ripple voltage.

Temperature Stability of Vo: The percentage change in output voltage for a thermal variation from room temperature true to either temperature extreme.