



LM2937

LINEAR INTEGRATED CIRCUIT

500mA LOW DROPOUT VOLTAGE REGULATOR

■ DESCRIPTION

The UTC **LM2937** is a positive voltage regulator capable of supplying up to 500mA of load current. The use of a PNP power transistor provides a low dropout voltage characteristic. With a load current of 500mA the minimum input to output voltage differential required for the output to remain in regulation is typically 0.5V(1V guaranteed maximum over the full operating temperature range). Special circuitry has been incorporated to minimize the quiescent current to typically only 10mA with a full 500mA load current when the input to output voltage differential is greater than 3V.

The UTC **LM2937** requires an output bypass capacitor for stability. As with most low dropout regulators, the ESR of this capacitor remains a critical design parameter, but the LM2937 includes special compensation circuitry that relaxes ESR requirements. The UTC **LM2937** is stable for all ESR below 3Ω. This allows the use of low ESR chip capacitors.

Ideally suited for automotive applications, the UTC **LM2937** will protect itself and any load circuitry from reverse battery connections, two-battery jumps and up to +60V/-50V load dump transients. Familiar regulator features such as short circuit and thermal shutdown protection are also built in.

■ FEATURES

- * Fully specified for operation over -40°C~ +125°C
- * Output current in excess of 500mA
- * Output trimmed for 5% tolerance under all operating conditions
- * Typical dropout voltage of 0.5V at full rated load current
- * Wide output capacitor ESR range, up to 3Ω
- * Reverse battery protection
- * Internal short circuit and thermal overload protection
- * 60V input transient protection
- * Mirror image insertion protection
- * Built-in ON/OFF control function

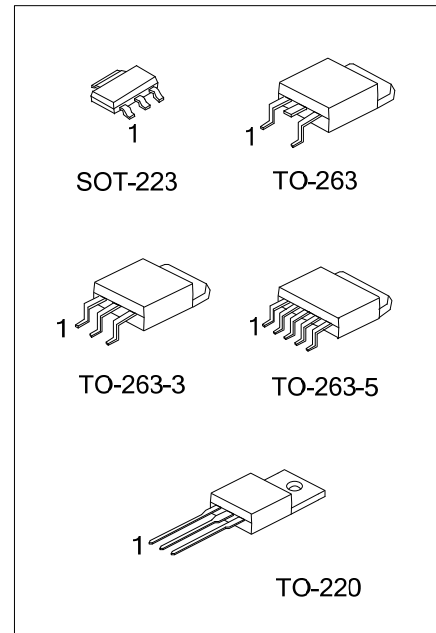

ORDERING INFORMATION

Order Number		Package	Packing
Lead Free	Halogen Free		
-	LM2937G-xx-AA3-R	SOT-223	Tape Reel
LM2937L-xx-TA3-T	LM2937G-xx-TA3-T	TO-220	Tube
LM2937L-xx-TQ2-R	LM2937G-xx-TQ2-R	TO-263	Tape Reel
LM2937L-xx-TQ2-T	LM2937G-xx-TQ2-T	TO-263	Tube
LM2937L-xx-TQ3-R	LM2937G-xx-TQ3-R	TO-263-3	Tape Reel
LM2937L-xx-TQ3-T	LM2937G-xx-TQ3-T	TO-263-3	Tube
LM2937L-xx-TQ5-R	LM2937G-xx-TQ5-R	TO-263-5	Tape Reel
LM2937L-xx-TQ5-T	LM2937G-xx-TQ5-T	TO-263-5	Tube

<p>LM2937G-xx-AA3-R</p>	<p>(1) T: Tube, R: Tape Reel (2) AA3: SOT-223, TA3: TO-220, TQ2: TO-263 TQ3: TO-263-3, TQ5: TO-263-5 (3) xx: refer to Marking Information (4) G: Halogen Free and Lead Free, L: Lead Free</p>
-------------------------	---

MARKING INFORMATION

PACKAGE	VOLTAGE CODE	MARKING
SOT-223		
TO-220 TO-263 TO-263-3	33 : 3.3V 50 : 5.0V 80 : 8.0V 10 : 10V 12 : 12V 15 : 15V	
TO-263-5		

PIN CONFIGURATION

PIN NO.		PIN NAME
SOT-223/TO-220 TO-263/TO-263-3	TO-263-5	
1	4	Input
2	3	GND
3	5	Output
-	1	N/C
-	2	ON/OFF

■ ABSOLUTE MAXIMUM RATINGS (Note 1)

PARAMETER	SYMBOL	RATINGS	UNIT
Input Voltage	V_{IN}	26	V
Power Dissipation(Note 2)	P_D	Internally limited	
Maximum Junction Temperature	T_J	+150	°C
Storage Temperature	T_{STG}	-40 ~ +150	°C

Notes: 1. Absolute Maximum Ratings indicate limits beyond which damage to the device may occur. Electrical Specifications do not apply when operating the device outside of its rated Operating Conditions.

2. The maximum allowable power dissipation at any ambient temperature is $P_{MAX} = (125 - T_A) / \theta_{JA}$, where 125 is the maximum junction temperature for operation, T_A is the ambient temperature, and θ_{JA} is the junction to ambient thermal resistance. If this dissipation is exceeded, the die temperature will rise above 125°C and the electrical specifications do not apply. If the die temperature rises above 150°C, the LM2937 will go into thermal shutdown.

■ THERMAL DATA

PARAMETER	SYMBOL	RATINGS	UNIT
Junction to Ambient	SOT-223	174	°C/W
	TO-220	65	
	TO-263/ TO-263-5	73	
Junction to Case	SOT-223	15	
	TO-220	3	
	TO-263/ TO-263-5	4	

■ ELECTRICAL CHARACTERISTICS

($V_{IN} = V_{NOM} + 5V$, $I_{OUT} = 500mA$, $C_{OUT} = 10\mu F$, $T_J = T_A = 25^\circ C$, unless otherwise specified.)

For LM2937-3.3V

PARAMETER	SYMBOL	TEST CONDITIONS	MIN	TYP	MAX	UNIT
Output Voltage	V_{OUT}	$5mA \leq I_{OUT} \leq 500mA$	3.21	3.30	3.39	V
Line Regulation	ΔV_{OUT}	$V_{OUT} + 2V \leq V_{IN} \leq 26V$, $I_{OUT} = 5mA$		9	30	mV
Load Regulation	ΔV_{OUT}	$5mA \leq I_{OUT} \leq 500mA$		3	30	mV
Quiescent Current	I_Q	$(V_O + 2V) \leq V_{IN} \leq 26V$, $I_{OUT} = 5mA$		2	10	mA
		$V_{IN} = V_{OUT} + 5V$, $I_{OUT} = 500mA$		10	20	mA
Output Noise Voltage	eN	10Hz-100kHz, $I_{OUT} = 5mA$		100		μV_{rms}
Long Term Stability		1000Hrs		12		mV
Dropout Voltage	V_D	$I_{OUT} = 500mA$		0.5	1.0	V
		$I_{OUT} = 50mA$		110	250	mV
Short Circuit Current	I_{SC}		0.6	1.0		A
Peak Line Transient Voltage	T_{IN}	$t_F \leq 100ms$, $R_L = 100\Omega$	60	75		V
Reverse DC Input Voltage	V_{RIN}	$V_{OUT} \geq -0.6V$, $R_L = 100\Omega$	-15	-30		V
Reverse Transient Input Voltage	V_{TRRI}	$t_F < 1ms$, $R_L = 100\Omega$	-50	-75		V

■ ELECTRICAL CHARACTERISTICS (Cont.)

For LM2937-5.0V

PARAMETER	SYMBOL	TEST CONDITIONS	MIN	TYP	MAX	UNIT
Output Voltage	V_{OUT}	$5mA \leq I_{OUT} \leq 500mA$	4.85	5.00	5.15	V
Line Regulation	ΔV_{OUT}	$V_{OUT} + 2V \leq V_{IN} \leq 26V, I_{OUT} = 5mA$		15	50	mV
Load Regulation	ΔV_{OUT}	$5mA \leq I_{OUT} \leq 500mA$		5	50	mV
Quiescent Current	I_Q	$(V_{OUT} + 2V) \leq V_{IN} \leq 26V, I_{OUT} = 5mA$		2	10	mA
		$V_{IN} = V_{OUT} + 5V, I_{OUT} = 500mA$		10	20	mA
Output Noise Voltage	eN	10Hz-100kHz, $I_{OUT} = 5mA$		150		μV_{rms}
Long Term Stability		1000Hrs		20		mV
Dropout Voltage	V_D	$I_{OUT} = 500mA$		0.5	1.0	V
		$I_{OUT} = 50mA$		110	250	mV
Short Circuit Current	I_{SC}		0.6	1.0		A
Peak Line Transient Voltage	T_{IN}	$t_F \leq 100ms, R_L = 100\Omega$	60	75		V
Reverse DC Input Voltage	V_{RIN}	$V_{OUT} \geq -0.6V, R_L = 100\Omega$	-15	-30		V
Reverse Transient Input Voltage	V_{TRRI}	$t_F < 1ms, R_L = 100\Omega$	-50	-75		V

For LM2937-8.0V

PARAMETER	SYMBOL	TEST CONDITIONS	MIN	TYP	MAX	UNIT
Output Voltage	V_{OUT}	$5mA \leq I_{OUT} \leq 500mA$	7.76	8.00	8.24	V
Line Regulation	ΔV_{OUT}	$V_{OUT} + 2V \leq V_{IN} \leq 26V, I_{OUT} = 5mA$		24	80	mV
Load Regulation	ΔV_{OUT}	$5mA \leq I_{OUT} \leq 500mA$		8	80	mV
Quiescent Current	I_Q	$(V_{OUT} + 2V) \leq V_{IN} \leq 26V, I_{OUT} = 5mA$		2	10	mA
		$V_{IN} = V_o + 5V, I_{OUT} = 500mA$		10	20	mA
Output Noise Voltage	eN	10Hz-100kHz, $I_{OUT} = 5mA$		240		μV_{rms}
Long Term Stability		1000Hrs		32		mV
Dropout Voltage	V_D	$I_{OUT} = 500mA$		0.5	1.0	V
		$I_{OUT} = 50mA$		110	250	mV
Short Circuit Current	I_{SC}		0.6	1.0		A
Peak Line Transient Voltage	T_{IN}	$t_F \leq 100ms, R_L = 100\Omega$	60	75		V
Reverse DC Input Voltage	V_{RIN}	$V_{OUT} \geq -0.6V, R_L = 100\Omega$	-15	-30		V
Reverse Transient Input Voltage	V_{TRRI}	$t_F < 1ms, R_L = 100\Omega$	-50	-75		V

For LM2937-10.0V

PARAMETER	SYMBOL	TEST CONDITIONS	MIN	TYP	MAX	UNIT
Output Voltage	V_{OUT}	$5mA \leq I_{OUT} \leq 500mA$	9.70	10.00	10.30	V
Line Regulation	ΔV_{OUT}	$V_{OUT} + 2V \leq V_{IN} \leq 26V, I_{OUT} = 5mA$		30	100	mV
Load Regulation	ΔV_{OUT}	$5mA \leq I_{OUT} \leq 500mA$		10	100	mV
Quiescent Current	I_Q	$(V_{OUT} + 2V) \leq V_{IN} \leq 26V, I_{OUT} = 5mA$		2	10	mA
		$V_{IN} = V_{OUT} + 5V, I_{OUT} = 500mA$		10	20	mA
Output Noise Voltage	eN	10Hz-100kHz, $I_{OUT} = 5mA$		300		μV_{rms}
Long Term Stability		1000Hrs		40		mV
Dropout Voltage	V_D	$I_{OUT} = 500mA$		0.5	1.0	V
		$I_{OUT} = 50mA$		110	250	mV
Short Circuit Current	I_{SC}		0.6	1.0		A
Peak Line Transient Voltage	T_{IN}	$t_F \leq 100ms, R_L = 100\Omega$	60	75		V
Reverse DC Input Voltage	V_{RIN}	$V_{OUT} \geq -0.6V, R_L = 100\Omega$	-15	-30		V
Reverse Transient Input Voltage	V_{TRRI}	$t_F < 1ms, R_L = 100\Omega$	-50	-75		V

■ ELECTRICAL CHARACTERISTICS (Cont.)

For LM2937-12.0V

PARAMETER	SYMBOL	TEST CONDITIONS	MIN	TYP	MAX	UNIT
Output Voltage	V_{OUT}	$5mA \leq I_{OUT} \leq 500mA$	11.64	12.00	12.36	V
Line Regulation	ΔV_{OUT}	$V_{OUT} + 2V \leq V_{IN} \leq 26V, I_{OUT} = 5mA$		36	120	mV
Load Regulation	ΔV_{OUT}	$5mA \leq I_{OUT} \leq 500mA$		12	120	mV
Quiescent Current	I_Q	$(V_{OUT} + 2V) \leq V_{IN} \leq 26V, I_{OUT} = 5mA$		2	10	mA
		$V_{IN} = V_{OUT} + 5V, I_{OUT} = 500mA$		10	20	mA
Output Noise Voltage	eN	10Hz-100kHz, $I_{OUT} = 5mA$		360		μV_{rms}
Long Term Stability		1000Hrs		44		mV
Dropout Voltage	V_D	$I_{OUT} = 500mA$		0.5	1.0	V
		$I_{OUT} = 50mA$		110	250	mV
Short Circuit Current	I_{SC}		0.6	1.0		A
Peak Line Transient Voltage	T_{IN}	$t_F \leq 100ms, R_L = 100\Omega$	60	75		V
Reverse DC Input Voltage	V_{RIN}	$V_{OUT} \geq -0.6V, R_L = 100\Omega$	-15	-30		V
Reverse Transient Input Voltage	V_{TRRI}	$t_F < 1ms, R_L = 100\Omega$	-50	-75		V

For LM2937-15.0V

PARAMETER	SYMBOL	TEST CONDITIONS	MIN	TYP	MAX	UNIT
Output Voltage	V_{OUT}	$5mA \leq I_{OUT} \leq 500mA$	14.55	15.00	15.45	V
Line Regulation	ΔV_{OUT}	$V_{OUT} + 2V \leq V_{IN} \leq 26V, I_{OUT} = 5mA$		45	150	mV
Load Regulation	ΔV_{OUT}	$5mA \leq I_{OUT} \leq 500mA$		15	150	mV
Quiescent Current	I_Q	$(V_{OUT} + 2V) \leq V_{IN} \leq 26V, I_{OUT} = 5mA$		2	10	mA
		$V_{IN} = V_{OUT} + 5V, I_{OUT} = 500mA$		10	20	mA
Output Noise Voltage	eN	10Hz-100kHz, $I_{OUT} = 5mA$		450		μV_{rms}
Long Term Stability		1000Hrs		56		mV
Dropout Voltage	V_D	$I_{OUT} = 500mA$		0.5	1.0	V
		$I_{OUT} = 50mA$		110	250	mV
Short Circuit Current	I_{SC}		0.6	1.0		A
Peak Line Transient Voltage	T_{IN}	$t_F \leq 100ms, R_L = 100\Omega$	60	75		V
Reverse DC Input Voltage	V_{RIN}	$V_{OUT} \geq -0.6V, R_L = 100\Omega$	-15	-30		V
Reverse Transient Input Voltage	V_{TRRI}	$t_F < 1ms, R_L = 100\Omega$	-50	-75		V

■ ON/OFF CONTROL (For 5 pins only)

PARAMETER	SYMBOL	TEST CONDITIONS	MIN	TYP	MAX	UNIT
ON/OFF Threshold Voltage ON	V_{ON}	$I_{OUT} \leq 0.5A$			0.8	V
ON/OFF Threshold Voltage OFF	V_{OFF}	$I_{OUT} \leq 0.5A$	2.0			V
ON/OFF Threshold Current	$I_{ON/OFF}$	$V_{ON/OFF} = 2.0V, I_{OUT} = 0.5A$		50	100	μA

■ TYPICAL APPLICATION

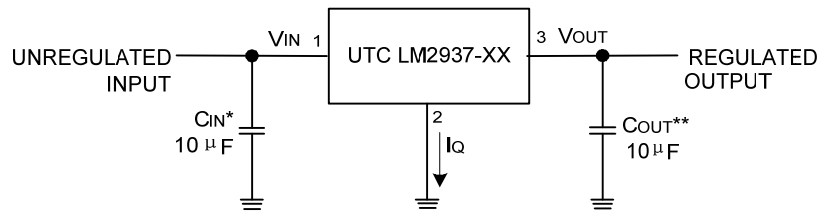

■ ON/OFF CONTROL APPLICATION

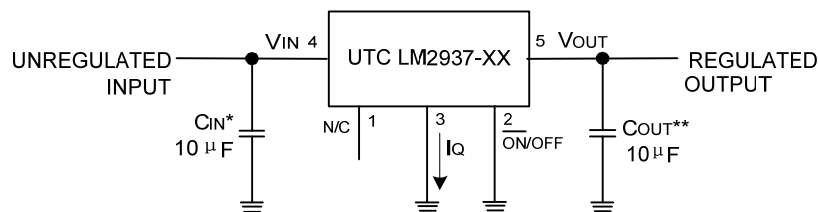

* Required if the regulator is located more than 3 inches from the power supply filter capacitors.

**Required for stability. C_{OUT} must be at least $10\mu F$ (over the full expected operating temperature range) and located as close as possible to the regulator. The equivalent series resistance, ESR, of this capacitor may be as high as 3Ω .

■ TYPICAL CHARACTERISTICS

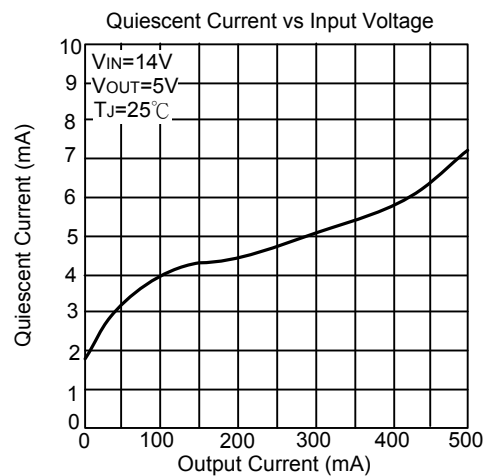
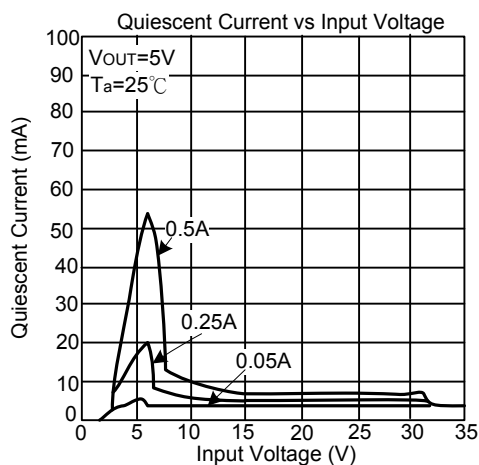
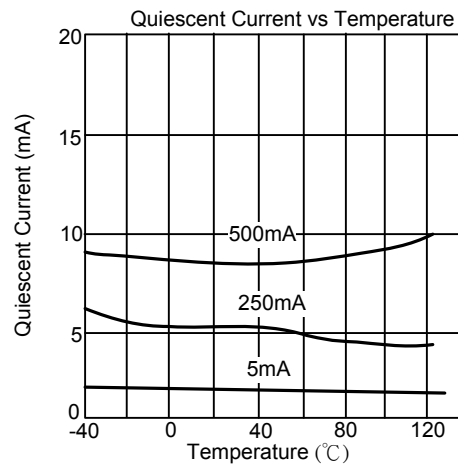
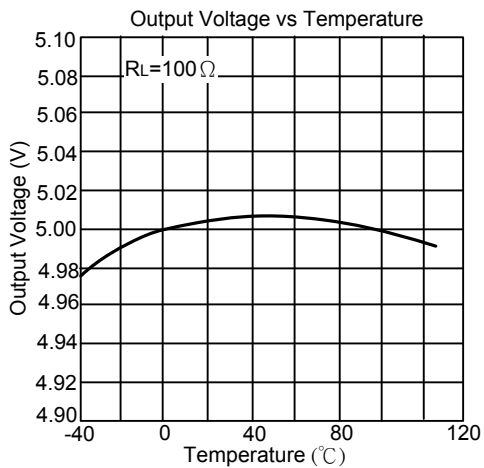
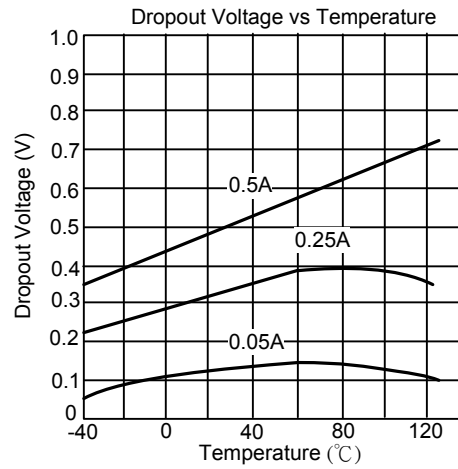
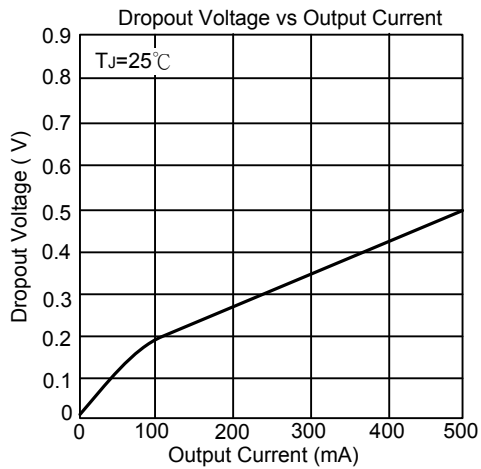

TYPICAL CHARACTERISTICS(Cont.)

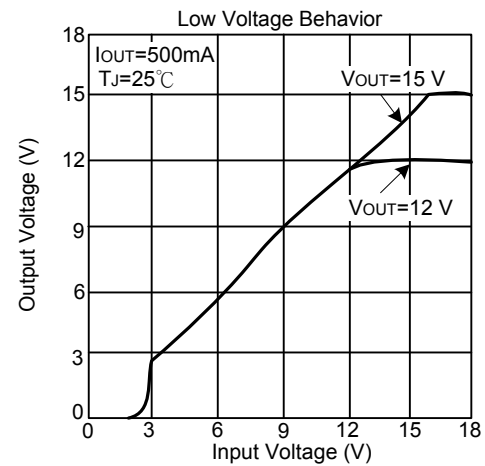
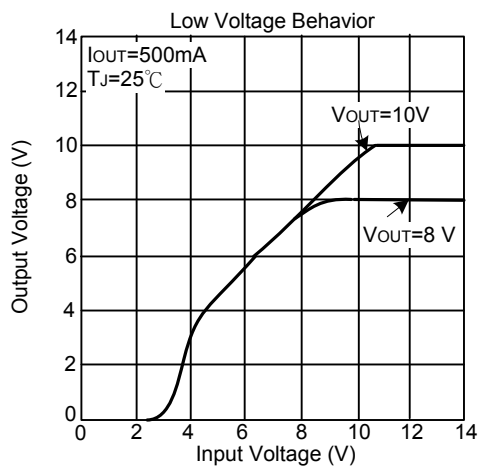
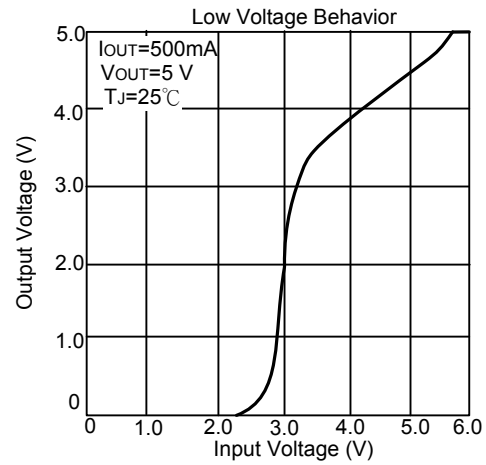
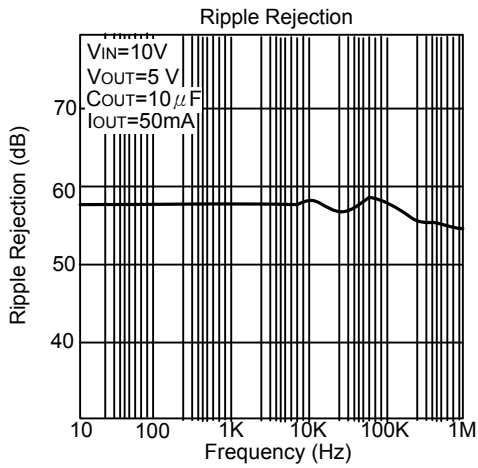
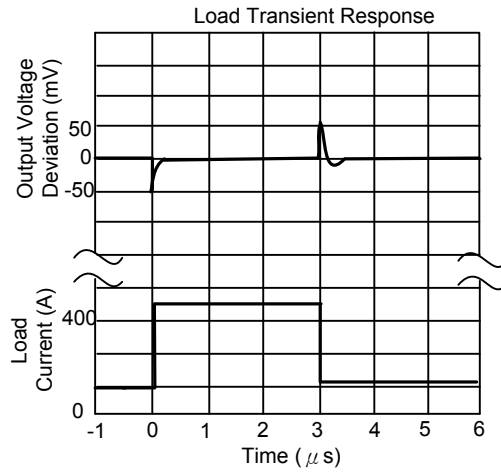
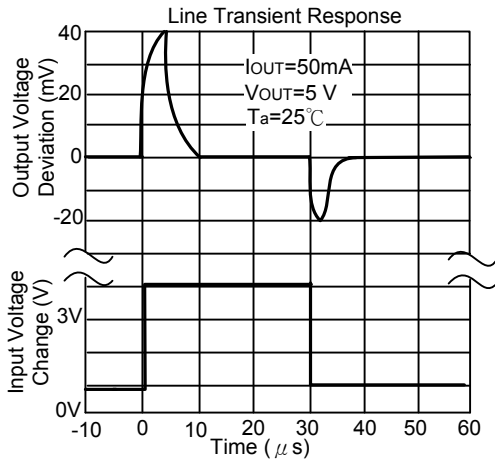

■ TYPICAL CHARACTERISTICS(Cont.)

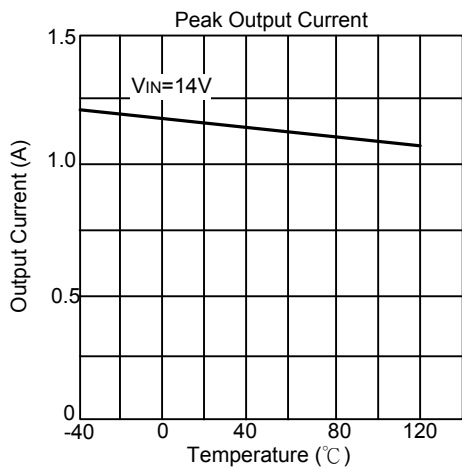
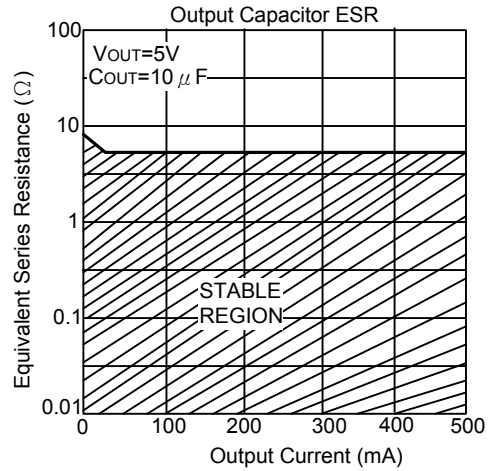
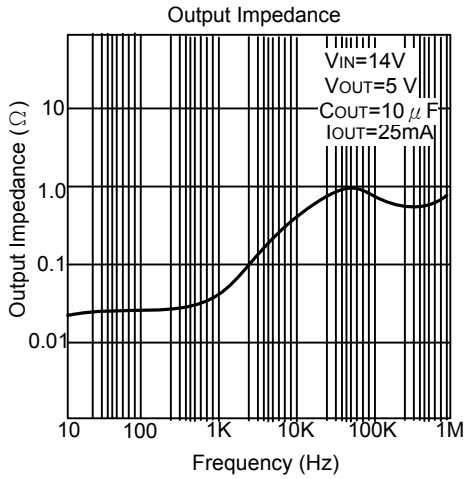
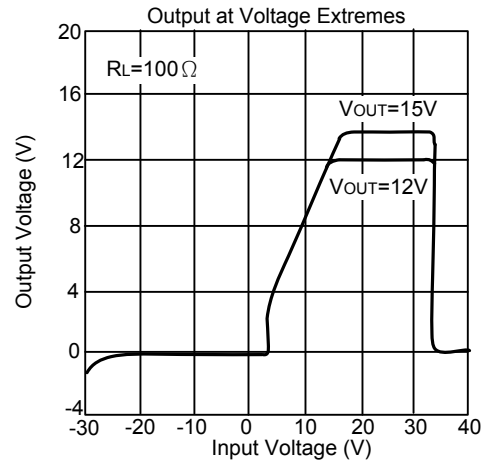
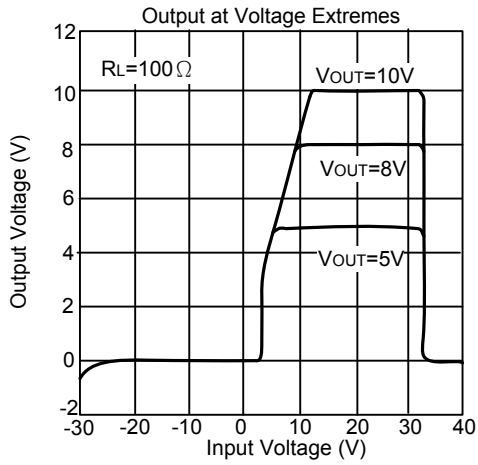

UTC assumes no responsibility for equipment failures that result from using products at values that exceed, even momentarily, rated values (such as maximum ratings, operating condition ranges, or other parameters) listed in products specifications of any and all UTC products described or contained herein. UTC products are not designed for use in life support appliances, devices or systems where malfunction of these products can be reasonably expected to result in personal injury. Reproduction in whole or in part is prohibited without the prior written consent of the copyright owner. The information presented in this document does not form part of any quotation or contract, is believed to be accurate and reliable and may be changed without notice.