

## LM2984 Microprocessor Power Supply System

### General Description

The LM2984 positive voltage regulator features three independent and tracking outputs capable of delivering the power for logic circuits, peripheral sensors and standby memory in a typical microprocessor system. The LM2984 includes circuitry which monitors both its own high-current output and also an external  $\mu\text{P}$ . If any error conditions are sensed in either, a reset error flag is set and maintained until the malfunction terminates. Since these functions are included in the same package with the three regulators, a great saving in board space can be realized in the typical microprocessor system. The LM2984 also features very low dropout voltages on each of its three regulator outputs (0.6V at the rated output current). Furthermore, the quiescent current can be reduced to 1 mA in the standby mode.

Designed also for vehicular applications, the LM2984 and all regulated circuitry are protected from reverse battery installations or 2-battery jumps. Familiar regulator features such as short circuit and thermal overload protection are also provided. Fixed outputs of 5V are available in the plastic TO-220 power package.

### Features

- Three low dropout tracking regulators
- Output current in excess of 500 mA
- Fully specified for  $-40^{\circ}\text{C}$  to  $+125^{\circ}\text{C}$  operation
- Low quiescent current standby regulator
- Microprocessor malfunction RESET flag
- Delayed RESET on power-up
- Accurate pretrimmed 5V outputs
- Reverse battery protection
- Overvoltage protection
- Reverse transient protection
- Short circuit protection
- Internal thermal overload protection
- ON/OFF switch for high current outputs
- P+ Product Enhancement tested

### Typical Application Circuit

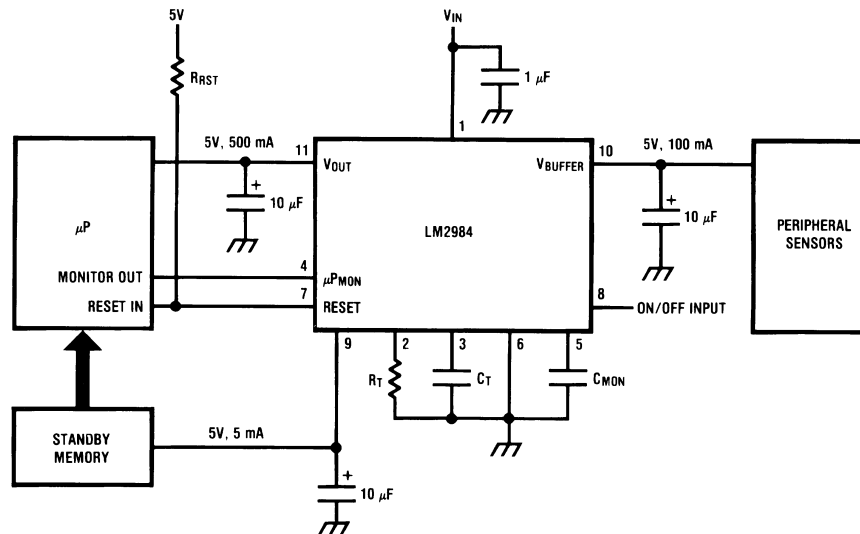

DS011252-1

$C_{OUT}$  must be at least  $10\ \mu\text{F}$  to maintain stability. May be increased without bound to maintain regulation during transients. Locate as close as possible to the regulator. This capacitor must be rated over the same operating temperature range as the regulator. The equivalent series resistance (ESR) of this capacitor is critical; see curve.

Order Number LM2984T  
See NS Package Number TA11B

### Absolute Maximum Ratings (Note 2)

If Military/Aerospace specified devices are required, please contact the National Semiconductor Sales Office/Distributors for availability and specifications.

Input Voltage	
Survival Voltage (<100 ms)	60V
Operational Voltage	26V
Internal Power Dissipation	Internally Limited

Operating Temperature Range ( $T_A$ )	-40°C to +125°C
Maximum Junction Temperature (Note 3)	150°C
Storage Temperature Range	-65°C to +150°C
Lead Temperature (Soldering, 10 sec.)	230°C
ESD Susceptibility (Note 5)	2000V

### Electrical Characteristics

$V_{IN} = 14V$ ,  $I_{OUT} = 5 mA$ ,  $C_{OUT} = 10 \mu F$ , unless otherwise indicated. **Boldface** type refers to limits over the entire operating temperature range,  $-40^\circ C \leq T_A \leq +125^\circ C$ , all other limits are for  $T_A = T_J = 25^\circ C$  (Note 8).

Parameter	Conditions	Typical	Limit (Note 4)	Units
<b><math>V_{OUT}</math> (Pin 11)</b>				
Output Voltage	$5 mA \leq I_O \leq 500 mA$ $6V \leq V_{IN} \leq 26V$	5.00	<b>4.85/4.75</b> <b>5.15/5.25</b>	$V_{min}$ $V_{max}$
Line Regulation	$9V \leq V_{IN} \leq 16V$	2	<b>25/25</b>	$mV_{max}$
	$7V \leq V_{IN} \leq 26V$	5	<b>50/50</b>	$mV_{max}$
Load Regulation	$5 mA \leq I_{OUT} \leq 500 mA$	12	<b>50/50</b>	$mV_{max}$
Output Impedance	$250 mA_{dc}$ and $10 mA_{rms}$ , $f_o = 120 Hz$	24		$m\Omega$
Quiescent Current	$I_{OUT} = 500 mA$	38	<b>100/100</b>	$mA_{max}$
	$I_{OUT} = 250 mA$	14	<b>50/50</b>	$mA_{max}$
Output Noise Voltage	10 Hz–100 kHz, $I_{OUT} = 100 mA$	100		$\mu V$
Long Term Stability		20		$mV/1000 hr$
Ripple Rejection	$f_o = 120 Hz$	70	<b>60/50</b>	$dB_{min}$
Dropout Voltage	$I_{OUT} = 500 mA$	0.53	<b>0.80/1.1</b>	$V_{max}$
	$I_{OUT} = 250 mA$	0.28	<b>0.50/0.70</b>	$V_{max}$
Current Limit		0.92	<b>0.75/0.60</b>	$A_{min}$
Maximum Operational Input Voltage	Continuous DC	32	<b>26/26</b>	$V_{min}$
Maximum Line Transient	$V_{OUT} \leq 6V$ , $R_{OUT} = 100\Omega$ , $T \leq 100 ms$	65	<b>60/60</b>	$V_{min}$
Reverse Polarity Input Voltage DC	$V_{OUT} \geq -0.6V$ , $R_{OUT} = 100\Omega$	-30	<b>-15/-15</b>	$V_{min}$
Reverse Polarity Input Voltage Transient	$T \leq 100 ms$ , $R_{OUT} = 100\Omega$	-55	<b>-35/-35</b>	$V_{min}$

### Electrical Characteristics

$V_{IN} = 14V$ ,  $I_{buf} = 5 mA$ ,  $C_{buf} = 10 \mu F$ , unless otherwise indicated. **Boldface** type refers to limits over the entire operating temperature range,  $-40^\circ C \leq T_A \leq +125^\circ C$ , all other limits are for  $T_A = T_J = 25^\circ C$  (Note 8).

Parameter	Conditions	Typical	Limit (Note 4)	Units
<b><math>V_{buffer}</math> (Pin 10)</b>				
Output Voltage	$5 mA \leq I_O \leq 100 mA$ $6V \leq V_{IN} \leq 26V$	5.00	<b>4.85/4.75</b> <b>5.15/5.25</b>	$V_{min}$ $V_{max}$
Line Regulation	$9V \leq V_{IN} \leq 16V$	2	<b>25/25</b>	$mV_{max}$
	$7V \leq V_{IN} \leq 26V$	5	<b>50/50</b>	$mV_{max}$
Load Regulation	$5 mA \leq I_{buf} \leq 100 mA$	15	<b>50/50</b>	$mV_{max}$
Output Impedance	$50 mA_{dc}$ and $10 mA_{rms}$ , $f_o = 120 Hz$	200		$m\Omega$
Quiescent Current	$I_{buf} = 100 mA$	8.0	<b>15/15</b>	$mA_{max}$

## Electrical Characteristics (Continued)

$V_{IN} = 14V$ ,  $I_{buf} = 5 mA$ ,  $C_{buf} = 10 \mu F$ , unless otherwise indicated. **Boldface** type refers to limits over the entire operating temperature range,  $-40^{\circ}C \leq T_A \leq +125^{\circ}C$ , all other limits are for  $T_A = T_J = 25^{\circ}C$  (Note 8) .

Parameter	Conditions	Typical	Limit (Note 4)	Units
<b>V<sub>buffer</sub> (Pin 10)</b>				
Output Noise Voltage	10 Hz–100 kHz, $I_{OUT} = 100 mA$	100		$\mu V$
Long Term Stability		20		mV/1000 hr
Ripple Rejection	$f_o = 120 Hz$	70	<b>60/50</b>	dB <sub>min</sub>
Dropout Voltage	$I_{buf} = 100 mA$	0.35	<b>0.50/0.80</b>	$V_{max}$
Current Limit		0.23	<b>0.15/0.15</b>	$A_{min}$
Maximum Operational Input Voltage	Continuous DC	32	<b>26/26</b>	$V_{min}$
Maximum Line Transient	$V_{buf} \leq 6V$ , $R_{buf} = 100\Omega$ , $T \leq 100 ms$	65	<b>60/60</b>	$V_{min}$
Reverse Polarity Input Voltage DC	$V_{buf} \geq -0.6V$ , $R_{buf} = 100\Omega$	-30	<b>-15/-15</b>	$V_{min}$
Reverse Polarity Input Voltage Transient	$T \leq 100 ms$ , $R_{buf} = 100\Omega$	-55	<b>-35/-35</b>	$V_{min}$

## Electrical Characteristics

$V_{IN} = 14V$ ,  $I_{stby} = 1 mA$ ,  $C_{stby} = 10 \mu F$ , unless otherwise indicated. **Boldface** type refers to limits over the entire operating temperature range,  $-40^{\circ}C \leq T_A \leq +125^{\circ}C$ , all other limits are for  $T_A = T_J = 25^{\circ}C$  (Note 8) .

Parameter	Conditions	Typical	Limit (Note 4)	Units
<b>V<sub>standby</sub> (Pin 9)</b>				
Output Voltage	$1 mA \leq I_O \leq 7.5 mA$ $6V \leq V_{IN} \leq 26V$	5.00	<b>4.85/4.75</b> <b>5.15/5.25</b>	$V_{min}$ $V_{max}$
Line Regulation	$9V \leq V_{IN} \leq 16V$ $7V \leq V_{IN} \leq 26V$	2 5	<b>25/25</b> <b>50/50</b>	$mV_{max}$ $mV_{max}$
Load Regulation	$0.5 mA \leq I_{OUT} \leq 7.5 mA$	6	<b>50/50</b>	$mV_{max}$
Output Impedance	$5 mA_{dc}$ and $1 mA_{rms}$ , $f_o = 120 Hz$	0.9		$\Omega$
Quiescent Current	$I_{stby} = 7.5 mA$ $I_{stby} = 2 mA$	1.2 0.9	<b>2.0/4.0</b> <b>1.5/4.0</b>	$mA_{max}$ $mA_{max}$
Output Noise Voltage	10 Hz–100 kHz, $I_{stby} = 1 mA$	100		$\mu V$
Long Term Stability		20		mV/1000 hr
Ripple Rejection	$f_o = 120 Hz$	70	<b>60/50</b>	dB <sub>min</sub>
Dropout Voltage	$I_{stby} = 1 mA$ $I_{stby} = 7.5 mA$	0.26 0.38	<b>0.50/0.60</b> <b>0.60/0.70</b>	$V_{max}$ $V_{max}$
Current Limit		15	<b>12/12</b>	$mA_{min}$
Maximum Operational Input Voltage	$4.5V \leq V_{stby} \leq 6V$ , $R_{stby} = 1000\Omega$	65	<b>60/60</b>	$V_{min}$
Maximum Line Transient	$V_{stby} \leq 6V$ , $T \leq 100 ms$ , $R_{stby} = 1000\Omega$	65	<b>60/60</b>	$V_{min}$
Reverse Polarity Input Voltage DC	$V_{stby} \geq -0.6V$ , $R_{stby} = 1000\Omega$	-30	<b>-15/-15</b>	$V_{min}$
Reverse Polarity Input Voltage Transient	$T \leq 100 ms$ , $R_{stby} = 1000\Omega$	-55	<b>-35/-35</b>	$V_{min}$

## Electrical Characteristics

$V_{IN} = 14V$ ,  $C_{OUT} = 10 \mu F$ ,  $C_{buf} = 10 \mu F$ ,  $C_{stby} = 10 \mu F$ , unless otherwise indicated. **Boldface** type refers to limits over the entire operating temperature range,  $-40^{\circ}C \leq T_A \leq +125^{\circ}C$ , all other limits are for  $T_A = T_J = 25^{\circ}C$  (Note 8).

Parameter	Conditions	Typical	Limit (Note 4)	Units
<b>Tracking and Isolation</b>				
Tracking $V_{OUT} - V_{stby}$	$I_{OUT} \leq 500 \text{ mA}$ , $I_{buf} = 5 \text{ mA}$ , $I_{stby} \leq 7.5 \text{ mA}$	$\pm 30$	$\pm 100/\pm 100$	$\text{mV}_{\text{max}}$
Tracking $V_{buf} - V_{stby}$	$I_{OUT} = 5 \text{ mA}$ , $I_{buf} \leq 100 \text{ mA}$ , $I_{stby} \leq 7.5 \text{ mA}$	$\pm 30$	$\pm 100/\pm 100$	$\text{mV}_{\text{max}}$
Tracking $V_{OUT} - V_{buf}$	$I_{OUT} \leq 500 \text{ mA}$ , $I_{buf} \leq 100 \text{ mA}$ , $I_{stby} = 1 \text{ mA}$	$\pm 30$	$\pm 100/\pm 100$	$\text{mV}_{\text{max}}$
Isolation (Note 1) $V_{buf}$ from $V_{OUT}$	$R_{OUT} = 1 \Omega$ , $I_{buf} \leq 100 \text{ mA}$	5.00	4.50/ <b>4.50</b> 5.50/ <b>5.50</b>	$V_{\text{min}}$ $V_{\text{max}}$
Isolation (Note 1) $V_{stby}$ from $V_{OUT}$	$R_{OUT} = 1 \Omega$ , $I_{stby} \leq 7.5 \text{ mA}$	5.00	4.50/ <b>4.50</b> 5.50/ <b>5.50</b>	$V_{\text{min}}$ $V_{\text{max}}$
Isolation (Note 1) $V_{OUT}$ from $V_{buf}$	$R_{buf} = 1 \Omega$ , $I_{OUT} \leq 500 \text{ mA}$	5.00	4.50/ <b>4.50</b> 5.50/ <b>5.50</b>	$V_{\text{min}}$ $V_{\text{max}}$
Isolation (Note 1) $V_{stby}$ from $V_{buf}$	$R_{buf} = 1 \Omega$ , $I_{stby} \leq 7.5 \text{ mA}$	5.00	4.50/ <b>4.50</b> 5.50/ <b>5.50</b>	$V_{\text{min}}$ $V_{\text{max}}$

**Note 1:** Isolation refers to the ability of the specified output to remain within the tested limits when the other output is shorted to ground.

## Electrical Characteristics

$V_{IN} = 14V$ ,  $I_{OUT} = 5 \text{ mA}$ ,  $I_{buf} = 5 \text{ mA}$ ,  $I_{stby} = 5 \text{ mA}$ ,  $R_t = 130 \text{ k}\Omega$ ,  $C_t = 0.33 \mu F$ ,  $C_{mon} = 0.47 \mu F$ , unless otherwise indicated. **Boldface** type refers to limits over the entire operating temperature range,  $-40^{\circ}C \leq T_A \leq +125^{\circ}C$ , all other limits are for  $T_A = T_J = 25^{\circ}C$  (Note 8).

Parameter	Conditions	Typical	Limit (Note 4)	Units
<b>Computer Monitor/Reset Functions</b>				
$I_{\text{reset LOW}}$	$V_{IN} = 4V$ , $V_{rst} = 0.4V$	5	2/ <b>0.50</b>	$\text{mA}_{\text{min}}$
$V_{\text{reset LOW}}$	$V_{IN} = 4V$ , $I_{rst} = 1 \text{ mA}$	0.10	0.40/ <b>0.40</b>	$V_{\text{max}}$
$R_t$ voltage	(Pin 2)	1.22	1.15/ <b>0.75</b>	$V_{\text{min}}$
		1.22	1.30/ <b>2.00</b>	$V_{\text{max}}$
Power On Reset Delay	$V_{\mu P_{\text{mon}}} = 5V$ ( $T_{\text{diy}} = 1.2 R_t C_t$ )	50	45/ <b>17.0</b> 55/ <b>80.0</b>	$\text{ms}_{\text{min}}$ $\text{ms}_{\text{max}}$
$\Delta V_{OUT}$ Low Reset Threshold	(Note 6)	-350	-225/ <b>-175</b> -500/ <b>-550</b>	$\text{mV}_{\text{min}}$ $\text{mV}_{\text{max}}$
$\Delta V_{OUT}$ High Reset Threshold	(Note 6)		600	225/ <b>175</b> 750/ <b>800</b>
Reset Output Leakage	$V_{\mu P_{\text{mon}}} = 5V$ , $V_{rst} = 12V$	0.01	1/ <b>5.0</b>	$\mu A_{\text{max}}$
$\mu P_{\text{mon}}$ Input Current (Pin 4)	$V_{\mu P_{\text{mon}}} = 2.4V$	7.5	25/ <b>25</b>	$\mu A_{\text{max}}$
	$V_{\mu P_{\text{mon}}} = 0.4V$	0.01	10/ <b>15</b>	$\mu A_{\text{max}}$
$\mu P_{\text{mon}}$ Input Threshold Voltage		1.22	0.80/ <b>0.80</b>	$V_{\text{min}}$
		1.22	2.00/ <b>2.00</b>	$V_{\text{max}}$
$\mu P$ Monitor Reset Oscillator Period	$V_{\mu P_{\text{mon}}} = 0V$ ( $T_{\text{window}} = 0.82 R_t C_{\text{mon}}$ )	50	45/ <b>30</b> 55/ <b>70</b>	$\text{ms}_{\text{min}}$ $\text{ms}_{\text{max}}$
$\mu P$ Monitor Reset Oscillator Pulse Width	$V_{\mu P_{\text{mon}}} = 0V$ ( $\text{RESET}_{\text{pw}} = 2000 C_{\text{mon}}$ )	1.0	0.7/ <b>0.4</b>	$\text{ms}_{\text{min}}$
		1.0	1.3/ <b>2.10</b>	$\text{ms}_{\text{max}}$
Minimum $\mu P$ Monitor Input Pulse Width	(Note 7)	2		$\mu s$
Reset Fall Time	$R_{rst} = 10k$ , $V_{rst} = 5V$ , $C_{rst} \leq 10 \text{ pF}$	0.20	1.00/ <b>1.00</b>	$\mu s_{\text{max}}$

## Electrical Characteristics (Continued)

$V_{IN} = 14V$ ,  $I_{OUT} = 5\text{ mA}$ ,  $I_{buf} = 5\text{ mA}$ ,  $I_{stby} = 5\text{ mA}$ ,  $R_t = 130\text{ k}\Omega$ ,  $C_t = 0.33\text{ }\mu\text{F}$ ,  $C_{mon} = 0.47\text{ }\mu\text{F}$ , unless otherwise indicated, **Boldface** type refers to limits over the entire operating temperature range,  $-40^\circ\text{C} \leq T_A \leq +125^\circ\text{C}$ , all other limits are for  $T_A = T_J = 25^\circ\text{C}$  (Note 8)

Parameter	Conditions	Typical	Limit (Note 4)	Units
<b>Computer Monitor/Reset Functions</b>				
Reset Rise Time	$R_{rst} = 10k$ , $V_{rst} = 5V$ , $C_{rst} \leq 10\text{ pF}$	0.60	1.00/ <b>1.50</b>	$\mu\text{s}_{max}$
On/Off Switch Input	$V_{ON} = 2.4V$	7.5	<b>25/25</b>	$\mu\text{A}_{max}$
Current (Pin 8)	$V_{ON} = 0.4V$	0.01	<b>10/10</b>	$\mu\text{A}_{max}$
On/Off Switch Input		1.22	<b>0.80/0.80</b>	$V_{min}$
Threshold Voltage		1.22	<b>2.00/2.00</b>	$V_{max}$

**Note 2:** Absolute Maximum Ratings indicate limits beyond which damage to the device may occur. DC and AC electrical specifications do not apply when operating the device beyond its specified operating ratings.

**Note 3:** Thermal resistance without a heatsink for junction-to-case temperature is  $3^\circ\text{C/W}$ . Thermal resistance case-to-ambient is  $40^\circ\text{C/W}$ .

**Note 4:** Tested Limits are guaranteed and 100% production tested.

**Note 5:** Human body model, 100 pF capacitor discharged through a 1500 $\Omega$  resistor.

**Note 6:** Internal comparators detect when the main regulator output ( $V_{OUT}$ ) changes from the measured output voltage (with  $V_{IN} = 14V$ ) by the specified amount,  $\Delta V_{OUT}$  High or  $\Delta V_{OUT}$  Low, and set the Reset Error Flag low. The Reset Error Flag is held low until  $V_{OUT}$  returns to regulation. The Reset Error Flag is then allowed to go high again after a delay set by  $R_t$  and  $C_t$ . (see application section).

**Note 7:** This parameter is a measure of how short a pulse can be detected at the  $\mu\text{P}$  Monitor Input. This parameter is primarily influenced by the value of  $C_{mon}$ . (See Application Hints Section.)

**Note 8:** To ensure constant junction temperature, low duty cycle pulse testing is used.

## Block Diagram

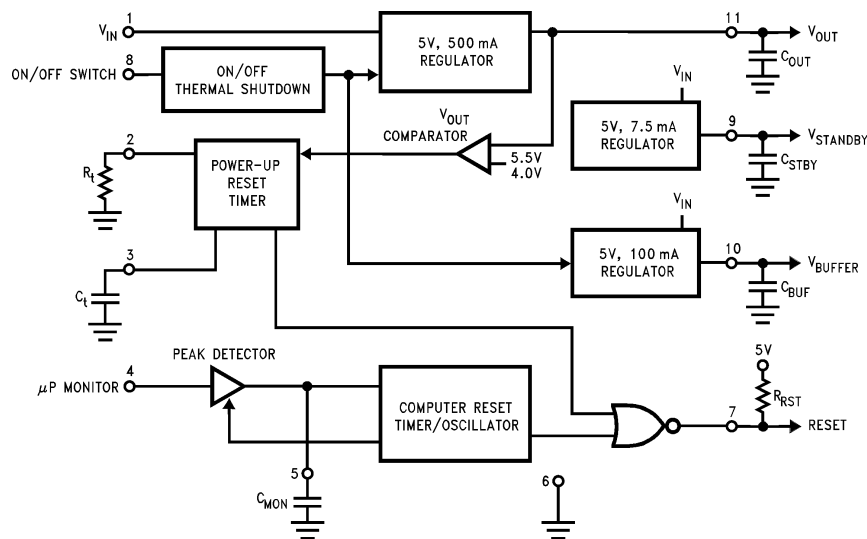

DS011252-2

## Pin Description

Pin No.	Pin Name	Comments
1	V <sub>IN</sub>	Positive supply input voltage
2	R <sub>t</sub>	Sets internal timing currents
3	C <sub>t</sub>	Sets power-up reset delay timing
4	μP <sub>mon</sub>	Microcomputer monitor input
5	C <sub>mon</sub>	Sets μC monitor timing
6	Ground	Regulator ground
7	Reset	Reset error flag output
8	ON/OFF	Enables/disables high current regulators
9	V <sub>standby</sub>	Standby regulator output (7.5 mA)
10	V <sub>buffer</sub>	Buffer regulator output (100 mA)
11	V <sub>OUT</sub>	Main regulator output (500 mA)

## External Components

Component	Typical Value	Component Range	Comments
C <sub>IN</sub>	1 μF	0.47 μF–10 μF	Required if device is located far from power supply filter.
R <sub>t</sub>	130k	24k–510k	Sets internal timing currents.
C <sub>t</sub>	0.33 μF	0.033 μF–3.3 μF	Sets power-up reset delay.
C <sub>tc</sub>	0.01 μF	0.001 μF–0.1 μF	Establishes time constant of AC coupled computer monitor.
R <sub>tc</sub>	10k	1k–100k	Establishes time constant of AC coupled computer monitor. (See applications section.)
C <sub>mon</sub>	0.47 μF	0.047 μF–4.7 μF	Sets time window for computer monitor. Also determines period and pulse width of computer malfunction reset. (See applications section.)
R <sub>rst</sub>	10k	5k–100k	Load for open collector reset output. Determined by computer reset input requirements.
C <sub>stby</sub>	10 μF	10 μF–no bound	A 10 μF is required for stability but larger values can be used to maintain regulation during transient conditions.
C <sub>buf</sub>	10 μF	10 μF–no bound	A 10 μF is required for stability but larger values can be used to maintain regulation during transient conditions.
C <sub>OUT</sub>	10 μF	10 μF–no bound	A 10 μF is required for stability but larger values can be used to maintain regulation during transient conditions.

## Typical Circuit Waveforms

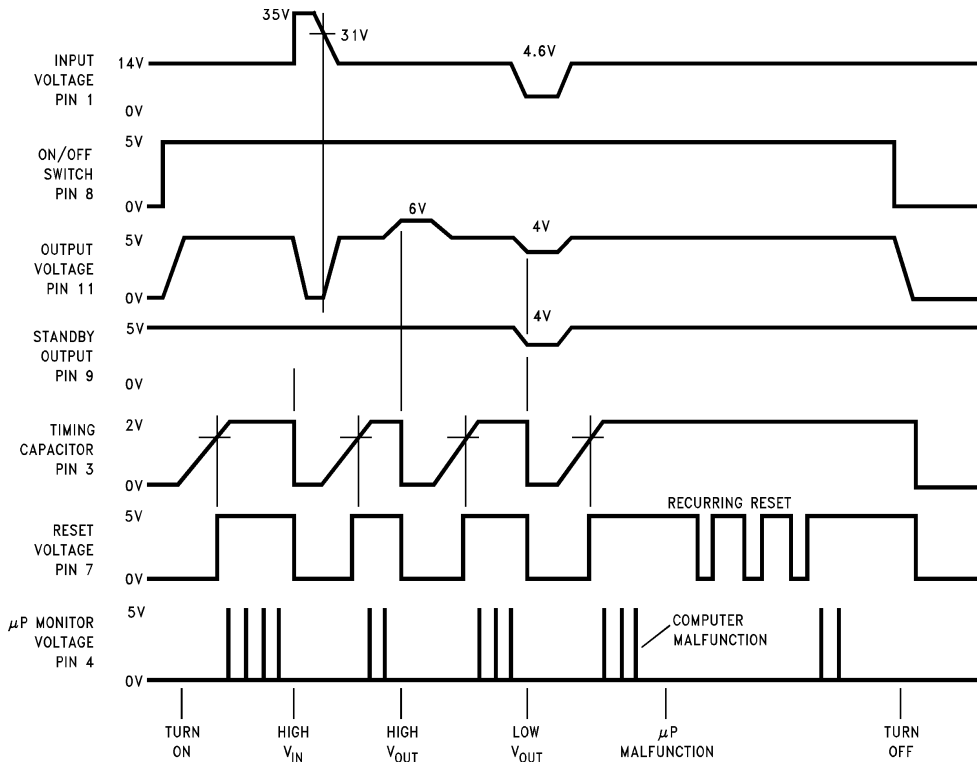

DS011252-3

## Connection Diagram

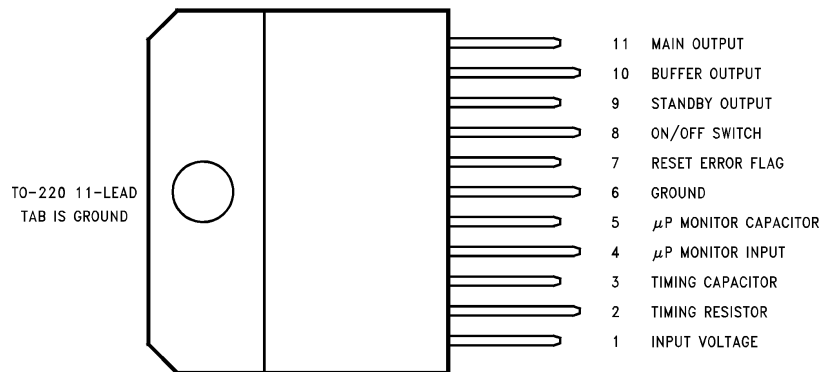

DS011252-4

Order Number LM2984T  
See NS Package Number TA11B

## Typical Performance Characteristics

**Dropout Voltage ( $V_{OUT}$ )**

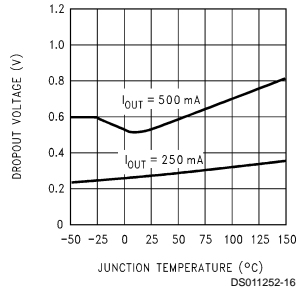

**Dropout Voltage ( $V_{buf}$ )**

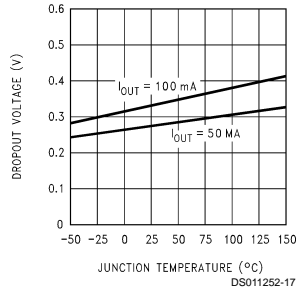

**Dropout Voltage ( $V_{stby}$ )**

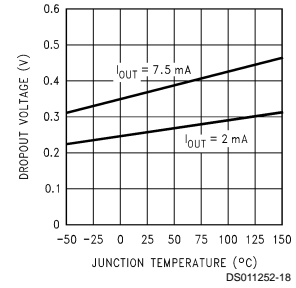

**Dropout Voltage ( $V_{OUT}$ )**

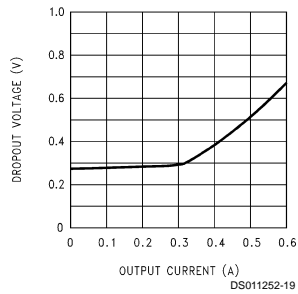

**Dropout Voltage ( $V_{buf}$ )**

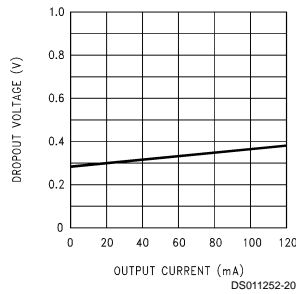

**Dropout Voltage ( $V_{stby}$ )**

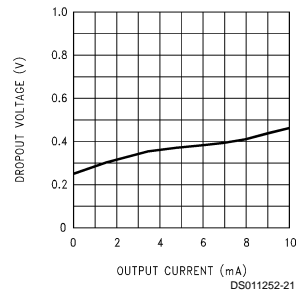

**Peak Output Current ( $V_{OUT}$ )**

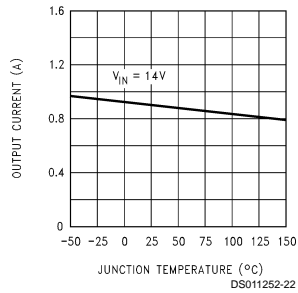

**Peak Output Current ( $V_{buf}$ )**

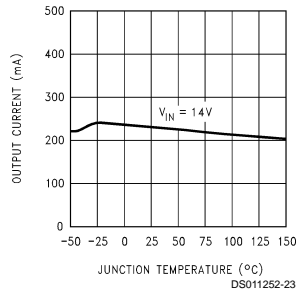

**Peak Output Current ( $V_{stby}$ )**

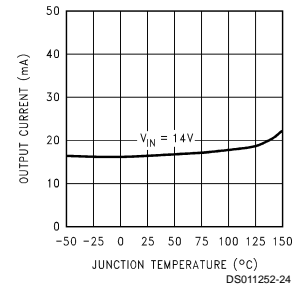

**Quiescent Current ( $V_{OUT}$ )**

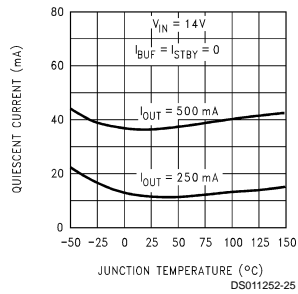

**Quiescent Current ( $V_{buf}$ )**

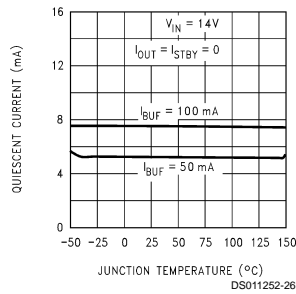

**Quiescent Current ( $V_{stby}$ )**

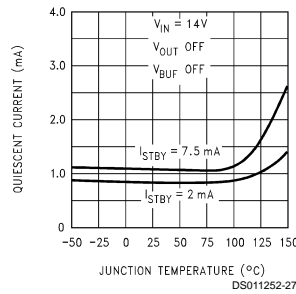



## Typical Performance Characteristics (Continued)

**Quiescent Current ( $V_{OUT}$ )**

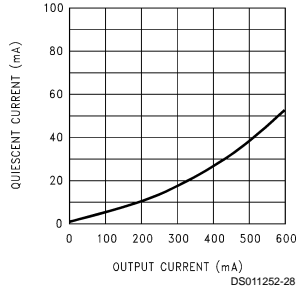

**Quiescent Current ( $V_{buf}$ )**

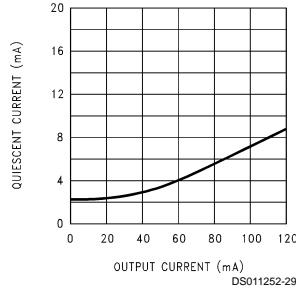

**Quiescent Current ( $V_{stby}$ )**

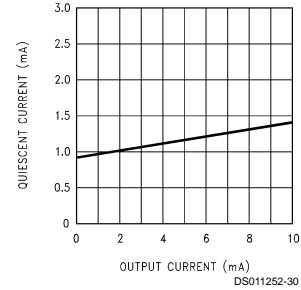

**Quiescent Current ( $V_{OUT}$ )**

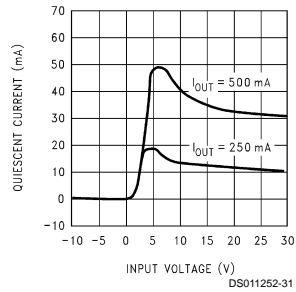

**Quiescent Current ( $V_{buf}$ )**

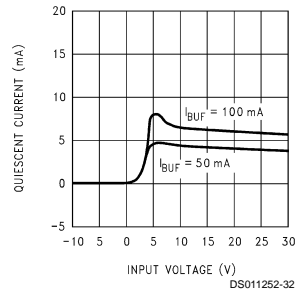

**Quiescent Current ( $V_{stby}$ )**

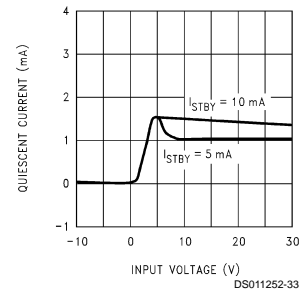

**Output Voltage ( $V_{OUT}$ )**

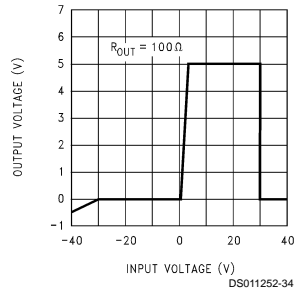

**Output Voltage ( $V_{buf}$ )**

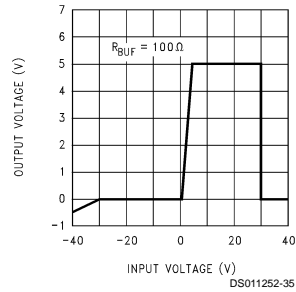

**Output Voltage ( $V_{stby}$ )**

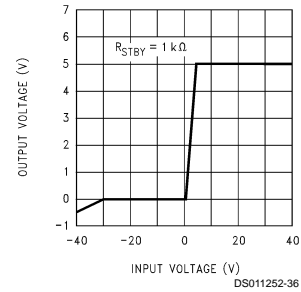

**Low Voltage Behavior ( $V_{OUT}$ )**

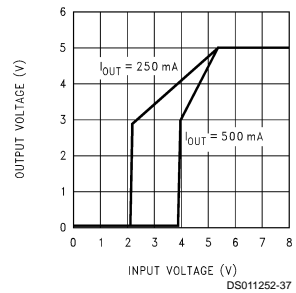

**Low Voltage Behavior ( $V_{buf}$ )**

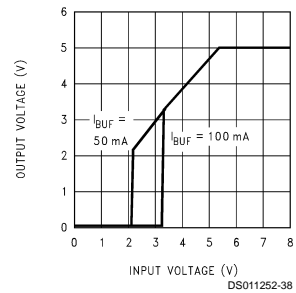

**Low Voltage Behavior ( $V_{stby}$ )**

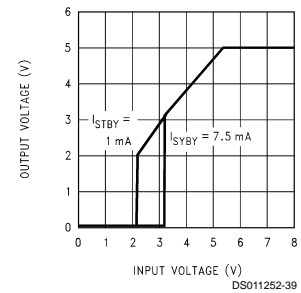

## Typical Performance Characteristics (Continued)

**Line Transient Response ( $V_{OUT}$ )**

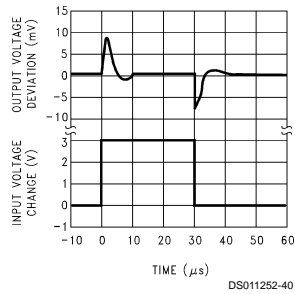

**Line Transient Response ( $V_{buf}$ )**

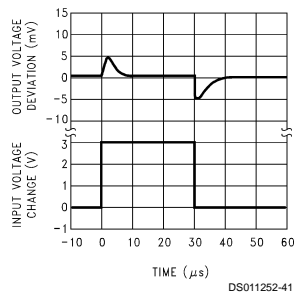

**Line Transient Response ( $V_{stby}$ )**

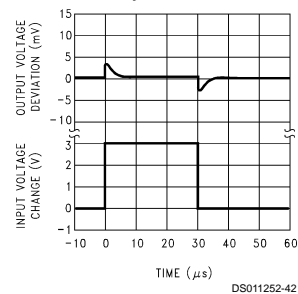

**Load Transient Response ( $V_{OUT}$ )**

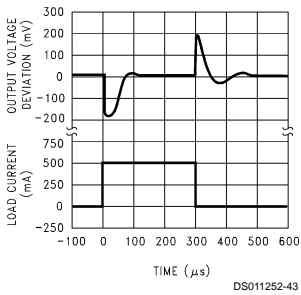

**Load Transient Response ( $V_{buf}$ )**

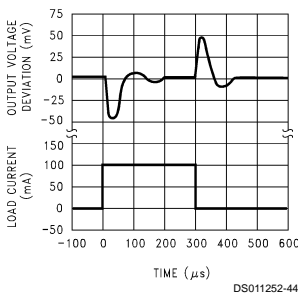

**Load Transient Response ( $V_{stby}$ )**

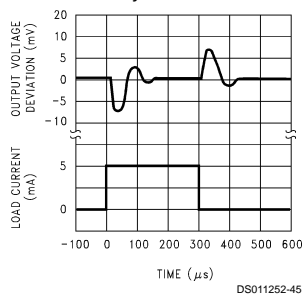

**Output Impedance ( $V_{OUT}$ )**

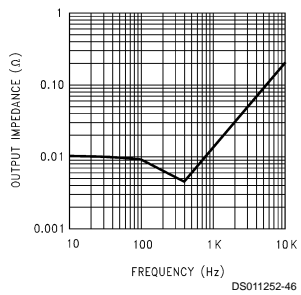

**Output Impedance ( $V_{buf}$ )**

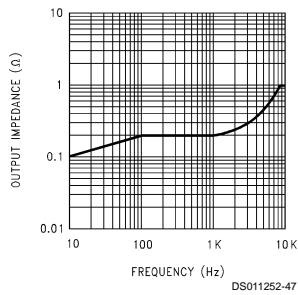

**Output Impedance ( $V_{stby}$ )**

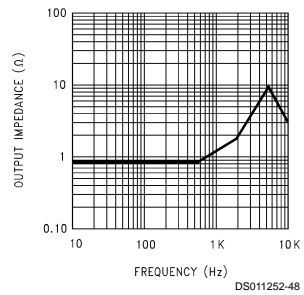

## Typical Performance Characteristics (Continued)

**Ripple Rejection ( $V_{OUT}$ )**

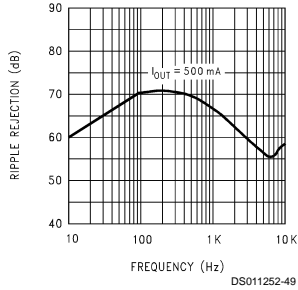

**Ripple Rejection ( $V_{BUF}$ )**

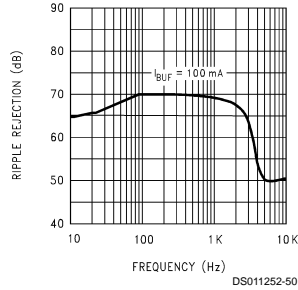

**Ripple Rejection ( $V_{STBY}$ )**

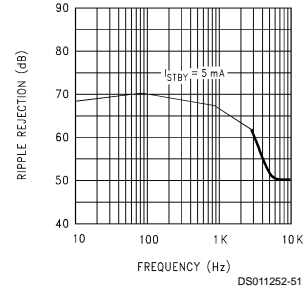

**Output Voltage**

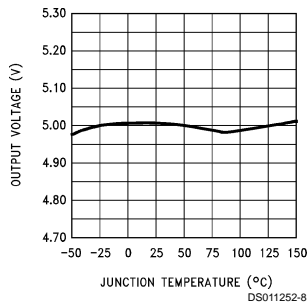

**Device Dissipation vs Ambient Temperature**

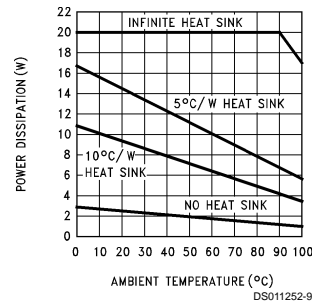

**Output Capacitor ESR (Standby Output, Pin 9)**

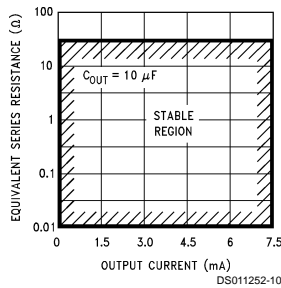

**Output Capacitor ESR (Buffer Output, Pin 10)**

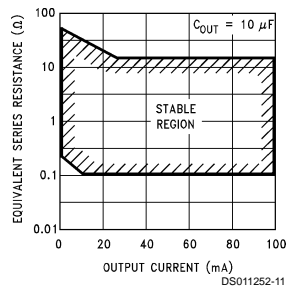

**Output Capacitor ESR (Main Output, Pin 11)**

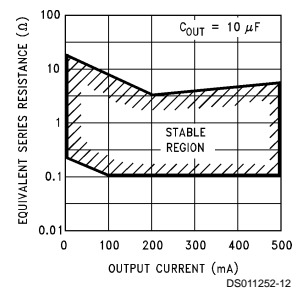

## Application Hints

### OUTPUT CAPACITORS

The LM2984 output capacitors are required for stability. Without them, the regulator outputs will oscillate, sometimes by many volts. Though the 10  $\mu\text{F}$  shown are the minimum recommended values, actual size and type may vary depending upon the application load and temperature range. Capacitor effective series resistance (ESR) also affects the IC stability. Since ESR varies from one brand to the next, some bench work may be required to determine the mini-

um capacitor value to use in production. Worst case is usually determined at the minimum ambient temperature and the maximum load expected.

Output capacitors can be increased in size to any desired value above the minimum. One possible purpose of this would be to maintain the output voltages during brief conditions of negative input transients that might be characteristic of a particular system.

Capacitors must also be rated at all ambient temperatures expected in the system. Many aluminum type electrolytics will freeze at temperatures less than  $-30^\circ\text{C}$ , reducing their

## Application Hints (Continued)

effective capacitance to zero. To maintain regulator stability down to  $-40^{\circ}\text{C}$ , capacitors rated at that temperature (such as tantalums) must be used.

Each output **must** be terminated by a capacitor, even if it is not used.

### STANDBY OUTPUT

The standby output is intended for use in systems requiring standby memory circuits. While the high current regulator outputs are controlled with the ON/OFF pin described later, the standby output remains on under all conditions as long as sufficient input voltage is supplied to the IC. Thus, memory and other circuits powered by this output remain unaffected by positive line transients, thermal shutdown, etc.

The standby regulator circuit is designed so that the quiescent current to the IC is very low ( $<1.5\text{ mA}$ ) when the other regulator outputs are off.

The capacitor on the output of this regulator can be increased without bound. This will help maintain the output voltage during negative input transients and will also help to reduce the noise on all three outputs. Because the other two track the standby output: therefore any noise reduction here will also reduce the other two noise voltages.

### BUFFER OUTPUT

The buffer output is designed to drive peripheral sensor circuitry in a  $\mu\text{P}$  system. It will track the standby and main regulator within a few millivolts in normal operation. Therefore, a peripheral sensor can be powered off this supply and have the same operating voltage as the  $\mu\text{P}$  system. This is important if a ratiometric sensor system is being used.

The buffer output can be short circuited while the other two outputs are in normal operation. This protects the  $\mu\text{P}$  system from disruption of power when a sensor wire, etc. is temporarily shorted to ground, i.e. only the sensor signal would be interrupted, while the  $\mu\text{P}$  and memory circuits would remain operational.

The buffer output is similar to the main output in that it is controlled by the ON/OFF switch in order to save power in the standby mode. It is also fault protected against overvoltage and thermal overload. If the input voltage rises above approximately 30V (e.g. load dump), this output will automatically shut down. This protects the internal circuitry and enables the IC to survive higher voltage transients than would otherwise be expected. Thermal shutdown is necessary since this output is one of the dominant sources of power dissipation in the IC.

### MAIN OUTPUT

The main output is designed to power relatively large loads, i.e. approximately 500 mA. It is therefore also protected against overvoltage and thermal overload.

This output will track the other two within a few millivolts in normal operation. It can therefore be used as a reference voltage for any signal derived from circuitry powered off the standby or buffer outputs. This is important in a ratiometric sensor system or any system requiring accurate matching of power supply voltages.

### ON/OFF SWITCH

The ON/OFF switch controls the main output and the buffer output. The threshold voltage is compatible with most logic families and has about 20 mV of hysteresis to insure "clean"

switching from the standby mode to the active mode and vice versa. This pin can be tied to the input voltage through a 10 k $\Omega$  resistor if the regulator is to be powered continuously.

### POWER DOWN OVERRIDE

Another possible approach is to use a diode in series with the ON/OFF signal in order to maintain power for some period of time after the ON/OFF signal has been removed (see Figure 1). When the ON/OFF switch is initially pulled high through diode D1, the main output will turn on and supply power through diode D2 to the ON/OFF switch effectively latching the main output. An open collector transistor Q1 is connected to the ON/OFF pin along with the two diodes and forces the regulators off after a period of time determined by the  $\mu\text{P}$ . In this way, the  $\mu\text{P}$  can override a power down command and store data, do housekeeping, etc. before reverting back to the standby mode.

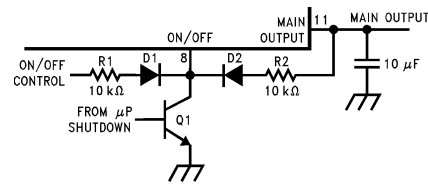

FIGURE 1. Power Down Override

### RESET OUTPUT

This output is an open collector NPN transistor which is forced low whenever an error condition is present at the main output or when a  $\mu\text{P}$  error is sensed (see  $\mu\text{P}$  Monitor section). If the main output voltage drops by 350 mV or rises out of regulation by 600 mV typically, the RESET output is forced low and held low for a period of time set by two external components,  $R_t$  and  $C_t$ . There is a slight amount of hysteresis in these two threshold voltages so that the RESET output has a fast rise and fall time compatible with the requirements of most  $\mu\text{P}$  RESET inputs.

### DELAYED RESET

Resistor  $R_t$  and capacitor  $C_t$  set the period of time that the RESET output is held low after a main output error condition has been sensed. The delay is given by the formula:

$$T_{\text{dly}} = 1.2 R_t C_t \text{ (seconds)}$$

The delayed RESET will be initiated any time the main output is out of regulation, i.e. during power-up, short circuit, overvoltage, low line, thermal shutdown or power-down. The  $\mu\text{P}$  is therefore RESET whenever the output voltage is out of regulation. (It is important to note that a RESET is only initiated when the main output is in error. The buffer and standby outputs are not directly monitored for error conditions.)

### $\mu\text{P}$ MONITOR RESET

There are two distinct and independent error monitoring systems in the LM2984. The one described above monitors the main regulator output and initiates a delayed RESET whenever this output is in error. The other error monitoring system is the  $\mu\text{P}$  watchdog. These two systems are OR'd together internally and both force the RESET output low when either type of error occurs.

## Application Hints (Continued)

This watchdog circuitry continuously monitors a pin on the  $\mu\text{P}$  that generates a positive going pulse during normal operation. The period of this pulse is typically on the order of milliseconds and the pulse width is typically on the order of 10's of microseconds. If this pulse ever disappears, the watchdog circuitry will time out and a RESET low will be sent to the  $\mu\text{P}$ . The time out period is determined by two external components,  $R_t$  and  $C_{\text{mon}}$ , according to the formula:

$$T_{\text{window}} = 0.82 R_t C_{\text{mon}} \text{ (seconds)}$$

The width of the RESET pulse is set by  $C_{\text{mon}}$  and an internal resistor according to the following:

$$\text{RESET}_{\text{pw}} = 2000 C_{\text{mon}} \text{ (seconds)}$$

A square wave signal can also be monitored for errors by filtering the  $C_{\text{mon}}$  input such that only the positive edges of the signal are detected. *Figure 2* is a schematic diagram of a typical circuit used to differentiate the input signal. Resistor  $R_{tc}$  and capacitor  $C_{tc}$  pass only the rising edge of the square wave and create a short positive pulse suitable for the  $\mu\text{P}$

monitor input. If the incoming signal continues in a high state or in a low state for too long a period of time, a RESET low will be generated.

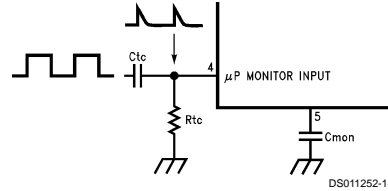

**FIGURE 2. Monitoring Square Wave  $\mu\text{P}$  Signals**

The threshold voltage and input characteristics of this pin are compatible with nearly all logic families.

There is a limit on the width of a pulse that can be reliably detected by the watchdog circuit. This is due to the output resistance of the transistor which discharges  $C_{\text{mon}}$  when a high state is detected at the input. The minimum detectable pulse width can be determined by the following formula:

$$\text{PW}_{\text{min}} = 20 C_{\text{mon}} \text{ (seconds)}$$

# Equivalent Schematic Diagram

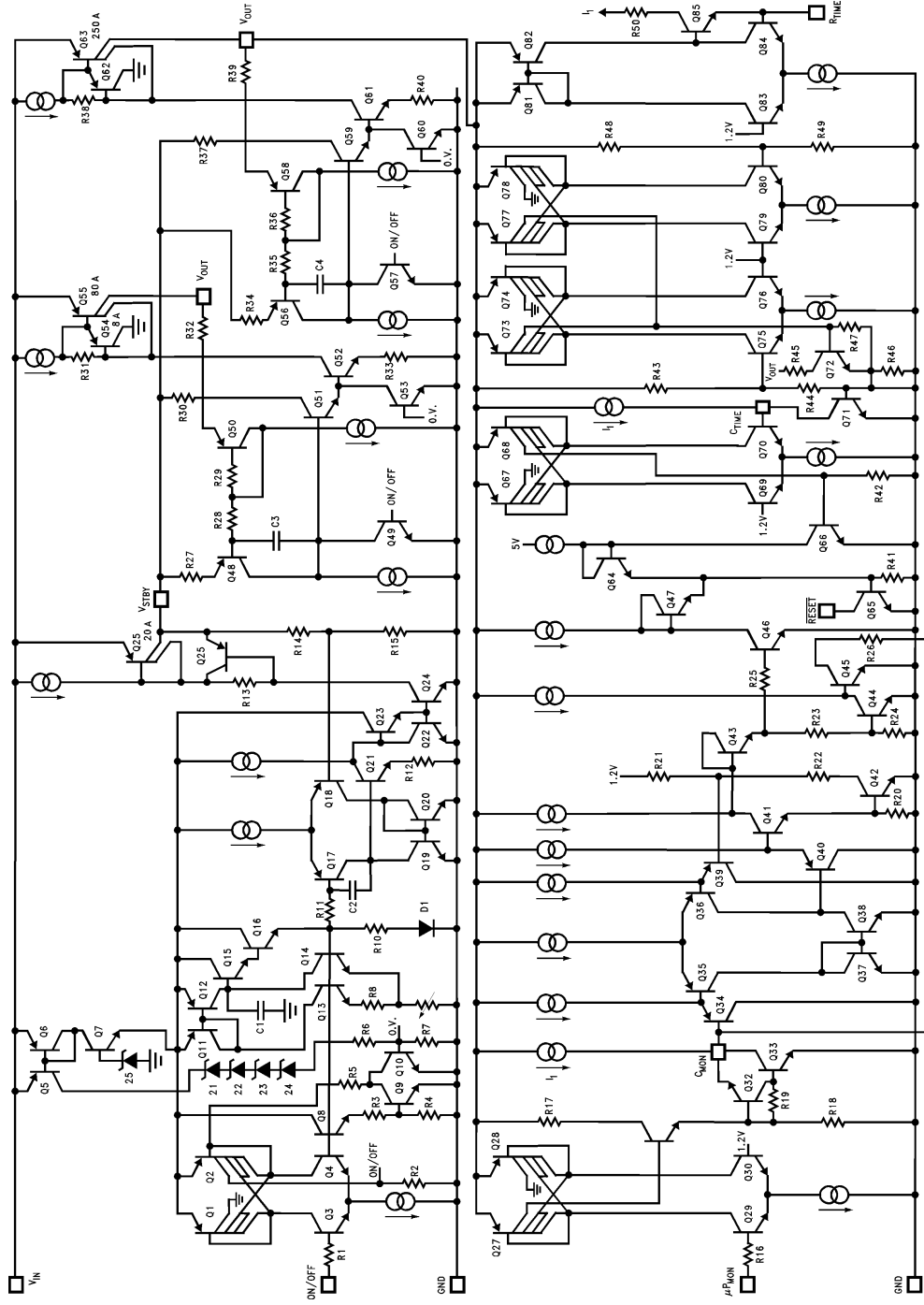

DS01252-15



**Physical Dimensions** inches (millimeters) unless otherwise noted

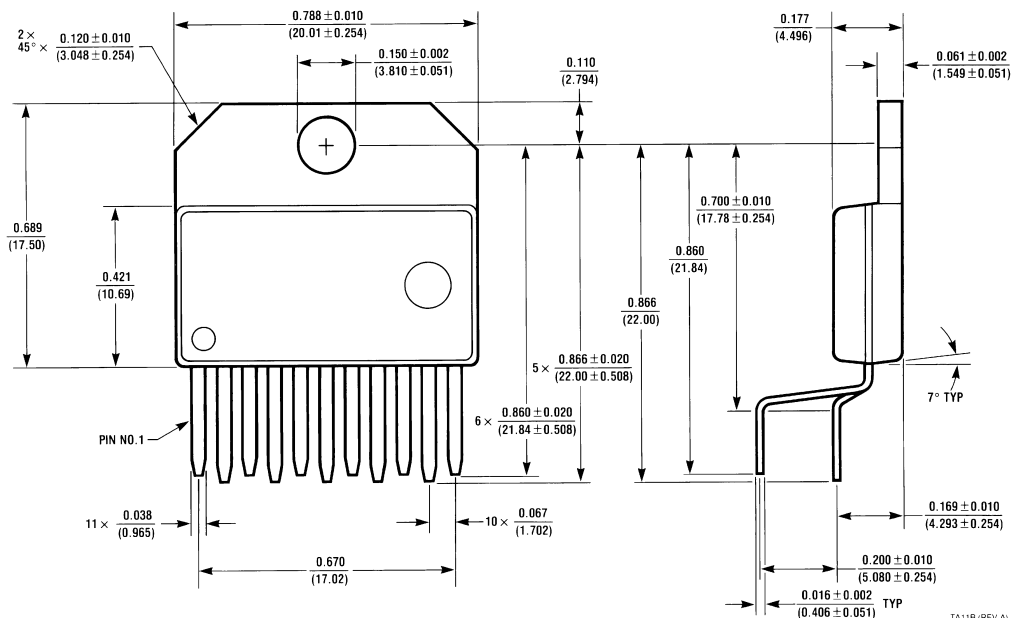

**Molded TO-220 Package (TA)  
Order Number LM2984T  
NS Package Number TA11B**

**LIFE SUPPORT POLICY**

NATIONAL'S PRODUCTS ARE NOT AUTHORIZED FOR USE AS CRITICAL COMPONENTS IN LIFE SUPPORT DEVICES OR SYSTEMS WITHOUT THE EXPRESS WRITTEN APPROVAL OF THE PRESIDENT OF NATIONAL SEMICONDUCTOR CORPORATION. As used herein:

1. Life support devices or systems are devices or systems which, (a) are intended for surgical implant into the body, or (b) support or sustain life, and whose failure to perform when properly used in accordance with instructions for use provided in the labeling, can be reasonably expected to result in a significant injury to the user.
2. A critical component in any component of a life support device or system whose failure to perform can be reasonably expected to cause the failure of the life support device or system, or to affect its safety or effectiveness.



**National Semiconductor Corporation**  
Americas  
Tel: 1-800-272-9959  
Fax: 1-800-737-7018  
Email: support@nsc.com

**National Semiconductor Europe**  
Fax: +49 (0) 1 80-530 85 86  
Email: europe.support@nsc.com  
Deutsch Tel: +49 (0) 1 80-530 85 85  
English Tel: +49 (0) 1 80-532 78 32  
Français Tel: +49 (0) 1 80-532 93 58  
Italiano Tel: +49 (0) 1 80-534 16 80

**National Semiconductor Asia Pacific Customer Response Group**  
Tel: 65-2544466  
Fax: 65-2504466  
Email: sea.support@nsc.com

**National Semiconductor Japan Ltd.**  
Tel: 81-3-5620-6175  
Fax: 81-3-5620-6179

www.national.com