



深圳市拓普微科技开发有限公司

SHENZHEN TOPWAY TECHNOLOGY CO., LTD.

LM3037BDW-1

LCD Module User Manual

Prepared by: Cai Date: 2009-02-12	Checked by: Date:	Approved by: Date:
---	----------------------------------	-----------------------------------

Rev.	Descriptions	Release Date
0.1	Preliminary New release	2009-02-12

Table of Content

1. Basic Specifications	3
1.1 Display Specifications	3
1.2 Mechanical Specifications	3
1.3 Block Diagram	3
2. Terminal Functions	4
3. Absolute Maximum Ratings	5
4. Electrical Characteristics	5
4.1 DC Characteristics	5
4.2 LED Backlight Circuit Characteristics	5
4.3 AC Characteristics (Parallel Mode Interface)	6
4.4 AC Characteristics (Serial Mode Interface)	7
4.5 Reset Timing	7
5. Function Specifications	8
5.1 Resetting the LCD module	8
5.2 Using Parallel interface	9
5.3 Using Serial interface	9
5.4 Display Memory Map	10
5.5 Display Control Instructions	12
6. Design and Handling Precaution	14

1. Basic Specifications

1.1 Display Specifications

- 1) LCD Display Mode : STN, Positive, Transmissive
- 2) Display Color : Display Data = "1" : Deep Blue (*1)
: Display Data = "0" : Light Gray (*2)
- 3) Viewing Angle : 6 H
- 4) Driving Method : 1/33 duty, 1/5bias
- 5) Back Light : White LED backlight

Note:

- *1. Color tone may slightly change by Temperature and Driving Condition
- *2. The Color is defined as the inactive / background color

1.2 Mechanical Specifications

- 1) Outline Dimension : 80.8 x 35.0 x 12.5MAX
(see attached Outline Drawing for details)

1.3 Block Diagram

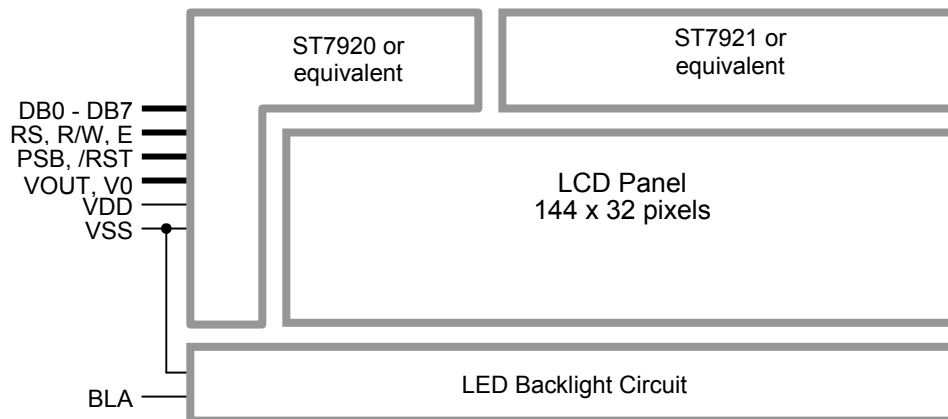

2. Terminal Functions

Pin No.	Pin Name	I/O	Descriptions	
			Parallel mode (PSB=H)	Serial Mode (PSB=L)
1	VSS	Power	Negative Power Supply, Ground (0V)	
2	VDD	Power	Positive Power Supply	
3	V0	Input	Contrast Reference Input	
4	RS (CS)	Input	Register Select RS=H; data read or write RS=L; Instruction data write or status busy flag read	Chip Select CS=H; chip enable CS=L; chip disable
5	R/W (SID)	Input	Read write control R/W=H; data or status read R/W=L; data or command write	Serial Input Data
6	E (SCLK)	Input	Enable trigger	Serial Clock
7	DB0	I/O	8-bit Data Bus	Leave open or pull-up
:	:	:	In 4 bit mode,	
14	DB7	I/O	DB3~DB0 could leave open or pull-up	
15	BLA	Power	Positive Power for LED backlight	
16	VOOUT	Power	Power Output for V0	
17	PSB		Interface selection: PSB=L; serial mode PSB=H; 8 or 4 bit parallel bus mode	
18	/RST	Input	System reset; low active	

3. Absolute Maximum Ratings

Items	Symbol	Min.	Max.	Unit	Condition
Supply Voltage	V_{DD}	-0.3	4.0	V	$V_{SS} = 0V$
Input Voltage	V_{IN}	-0.3	$V_{DD}+0.3$	V	$V_{SS} = 0V$
Operating Temperature	T_{OP}	-20	70	°C	No Condensation
Storage Temperature	T_{ST}	-30	80	°C	No Condensation

Cautions:

Any Stresses exceeding the Absolute Maximum Ratings may cause substantial damage to the device. Functional operation of this device at other conditions beyond those listed in the specification is not implied and prolonged exposure to extreme conditions may affect device reliability.

4. Electrical Characteristics

4.1 DC Characteristics

$V_{SS}=0V, V_{DD} =3.3V, T_{OP} =25^{\circ}C$

Items	Symbol	MIN.	TYP.	MAX.	Unit	Applicable Pin
Operating Voltage	V_{DD}	3.0	3.3	3.6	V	VDD
Input High Voltage	V_{IH1}	$0.8V_{DD}$	-	V_{DD}	V	RS, R/W, E, PSB, /RST, DB0-DB7
Input Low Voltage	V_{IL1}	V_{SS}	-	0.4	V	
Output High Voltage	V_{OH1}	$0.7V_{DD}$	-	V_{DD}	V	DB0-DB7 ($I_{OH} = -0.1mA$)
Output Low Voltage	V_{OL1}	V_{SS}	-	0.6	V	DB0-DB7 ($I_{OL} = 0.1mA$)
Operating Current	I_{DD}	-	1.4	3.0	mA	VDD

4.2 LED Backlight Circuit Characteristics

$V_{SS} =0V, I_{f_{BLA}}=40mA, T_{OP} =25^{\circ}C$

Items	Symbol	MIN.	TYP.	MAX.	Unit	Applicable Pin
Forward Voltage	$V_{f_{BLA}}$	-	3.3	-	V	BLA
Forward Current	$I_{f_{BLA}}$	-	40	50	mA	BLA

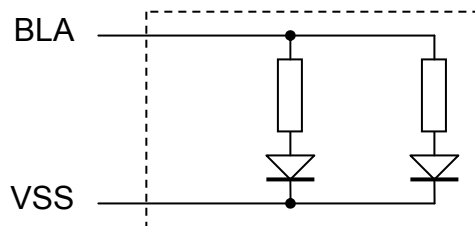

4.3 AC Characteristics (Parallel Mode Interface)

$V_{SS}=0V, V_{DD}=3.3V, T_{OP}=25^{\circ}C$

Item	Symbol	MIN.	TYP.	MAX.	Unit
E cycle time	tc	2250	-	-	ns
E high level width	tpw	400	-	-	ns
E rise time	tr	-	-	20	ns
E fall time	tf	-	-	20	ns
Address set-up time	tas	13	-	-	ns
Address hold time	tah	25	-	-	ns
Data set-up time	tdsw	50	-	-	ns
Data delay time	tddr	-	-	325	ns
Data hold time	th	25	-	-	ns

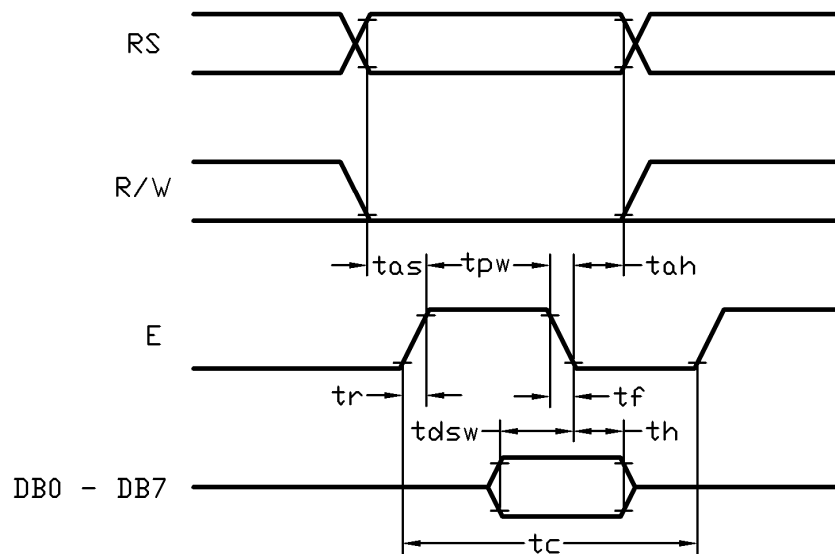

Host Write Timing Diagram (Parallel Mode)

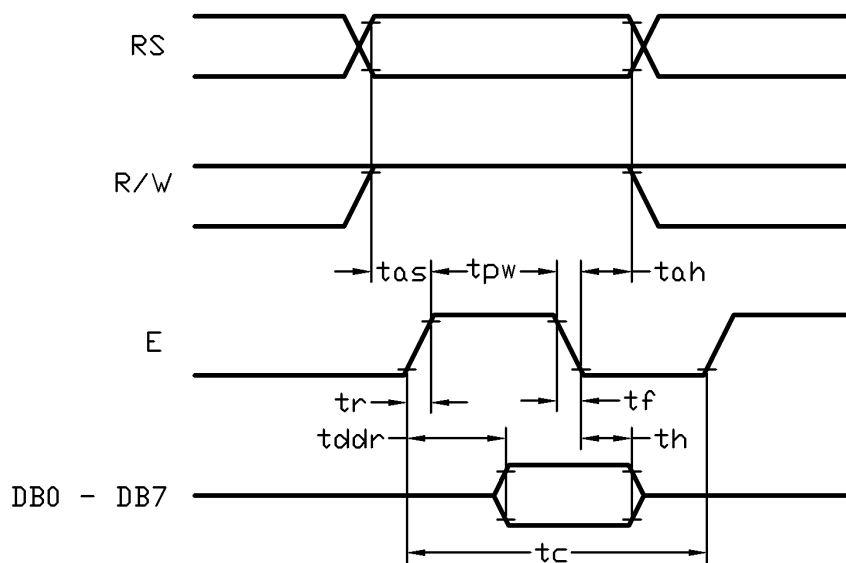

Host Read Timing Diagram (Parallel Mode)

4.4 AC Characteristics (Serial Mode Interface)

$V_{SS}=0V, V_{DD}=3.3V, T_{OP}=25^{\circ}C$

Item	Symbol	MIN.	TYP.	MAX.	Unit
Clock Cycle	tscyc	750	-	-	ns
SCLK high pulse width	tshw	375	-	-	ns
SCLK low pulse width	tslw	375	-	-	ns
SCLK rise time	tr	-	-	20	ns
SCLK fall time	tf	-	-	20	ns
SID data setup time	tsds	50	-	-	ns
SID data hold time	tsdh	50	-	-	ns
CS setup time	tcss	75	-	-	ns
CS hold time	tcsh	75	-	-	ns

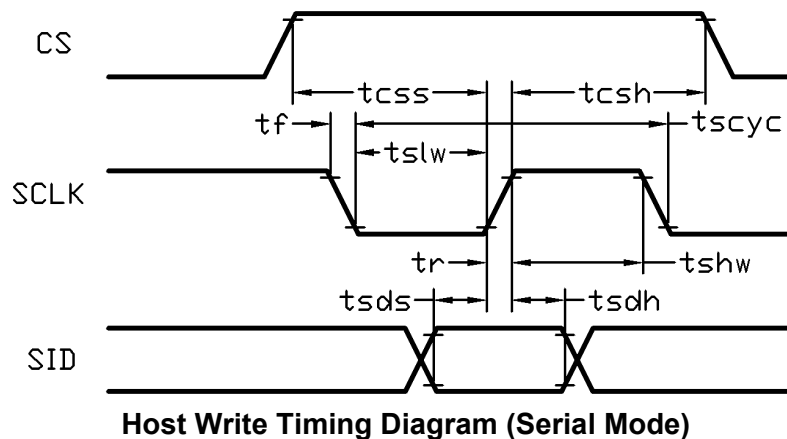

4.5 Reset Timing

$V_{SS}=0V, V_{DD}=3.3V, T_{OP}=25^{\circ}C$

Item	Symbol	MIN.	TYP.	MAX.	Unit
Reset Pulse width	trw	2.0	-	-	us
Reset Start time	tres	-	-	100	ns

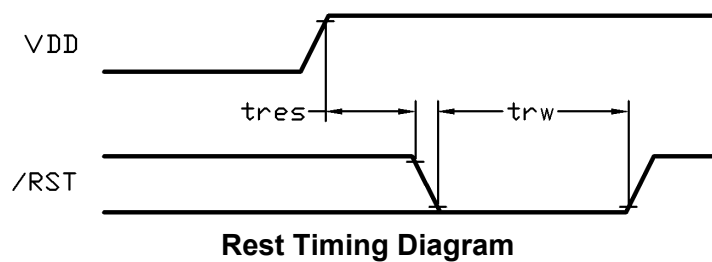

5. Function Specifications

5.1 Adjusting the LCD Display Contrast

A Variable-Resistor must be connected to the LCD module for providing a reference to V0. Adjusting the VR will result the change of LCD display contrast. The recommended value of VR is 5k Ohm.

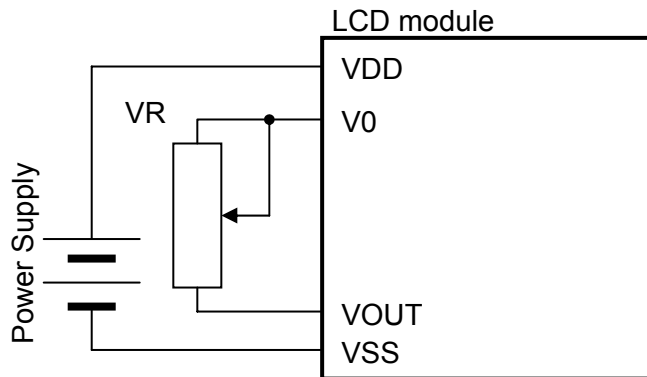

5.2 Resetting the LCD module

The LCD module should be initialized by setting /RST terminal at low level when turning the power on. See the reset timing section for details.

The initialized status is as follow:

Functions	Initialized Status
ENTER MODE SET	I/D=1 cursor move to right S=0 DDRAM address counter (AC) plus 1
DISPLAY STATUS	D=0 display = OFF C=0 cursor = OFF B=0 cursor position blink = OFF
FUNCTION SET	DL=1 8bit Interface RE=0 Basic Instruction Set
SCROLL OR RAM ADDR. SELECT	SR=0 CGRAM address access is enabled
REVERSE	R1=0, R0=0 First line normal
EXTENDED FUNCTION SET	G=0 Graphic Display OFF

5.3 Using Parallel interface

When PSB=H, the LCD module is in parallel interface mode. 8-bit or 4-bit bus interface could be selected by FUNCTION SET instruction DL bit.

In 4-bit bus interface, every 8-bit instruction/data is separated into two parts. First, transfer the higher 4-bit (D7~D4). Then transfer the lower 4-bit (D3~D0). They are transferred via DB7~DB4 terminals, where DB3~DB0 are not in used (leave open or pull high)

5.4 Using Serial interface

When PSB=L, the LCD module is in serial interface mode (write only).

In this mode, CS pin should be used. CS=H, enable the data transfer. CS=L, reset the serial data counter, terminate the data transition and clear the data buffer.

As the controller IC have no instruction buffer area, it must wait for the previous instruction to finish before sending the next one. Thus transferring multiple instruction/data, execution time must be considered.

Starting a transmission, a start byte is required. It consists 5 consecutive "1" follow with a "0", a RS bit (Register Select bit) and a "0".

Then the 8bit instruction/data should be separated into 2 groups. First group is DB7 to DB4, followed by 4 consecutive "0". The second group is DB3 to DB0 with 4 consecutive "0". See the Data Sequence Diagram for details.

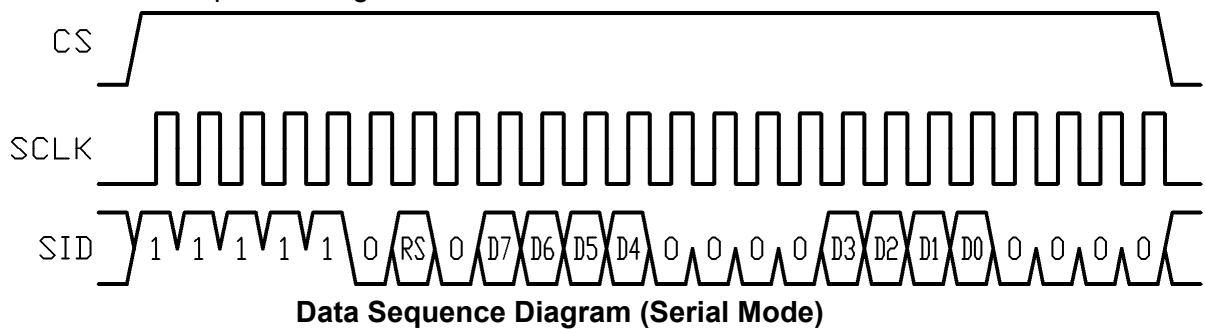

5.5 Display Memory Map

There are three main memory-areas in the LCD module for display.

- Character Generator RAM (CGRAM)
- Graphic Display RAM (GDRAM)
- Display Data RAM (DDRAM)

5.5.1 Character Generator RAM (CGRAM)

Character Generator RAM is for storing the User-defined Characters (a 16x16 dots font). There are only two characters could be defined.

The User-defined Character Codes are 0000h and 0002h. They could be called into DDRAM as normal character.

User-defined Character Code	CGRAM Address	CGRAM data	
		D15 ~ D8	D7 ~ D0
0000h	00h	16 x 16 dot font	16 x 16 dot font
	01h		
	⋮		
	⋮		
	0Eh		
	0Fh		
0002h	10h	16 x 16 dot font	16 x 16 dot font
	11h		
	⋮		
	⋮		
	1Eh		
	1Fh		

CGRAM Address Map

5.5.2 Graphics Display RAM (GDRAM)

GDRAM is for full graphics display. It could be displayed when G=1 (set by EXTENDED FUNCTION SET in Extended Instruction Set)

		Horizontal Address (X)				
		00h	01h	~	07h	08h
		D15 ~ D0	D15 ~ D0	~	D15 ~ D0	D15 ~ D0
Vertical Address (Y)	00h	144x32 pixels	144x32 pixels	144x32 pixels	144x32 pixels	144x32 pixels
	01h					
	⋮					
	⋮					
	1Eh					
	1Fh					

GDRAM Address Map

Note:

- *1. The mapping is based on Vertical Scroll Displacement Address=0.
- *2. Another 144x32 Graphics Display RAM space is not showed. They could be displayed by adjusting the Vertical Scroll Displacement Address value.

5.5.3 Display Data RAM (DDRAM)

GB Character Code (16bit, A1A0h~F7FFh) could write into DDRAM for displaying the Simplified Chinese Character (16x16 dots font). User Characters (16bit, 0000h or 0002h) defined by user that stored in CGRAM could also be used. The display character should be on grid only.

		DDRAM Address (Lower 4bit)													
		00h		01h		02h		~		06h		07h		08h	
		H	L	H	L	H	L	~		H	L	H	L	H	L
DDRAM Address (Upper 4bit)	80h	9 x 2 Characters (16x16 dots font)													
	90h														

DDRAM Address Map with 16x16 dots font

Note:

- *1. The mapping is based on Vertical Scroll Displacement Address=0.
- *2. Another 9x2(Character) Display Data RAM space is not showed. They could be displayed by adjusting the Vertical Scroll Displacement Address value.

Standard ASCII code (8bit, 00h~7Fh) could write into DDRAM for displaying the half-width Character (8x16 dots font). The display character should be on grid only, and two characters should be written in each write operation.

		DDRAM Address (Lower 4bit)													
		00h		01h		02h		~		06h		07h		08h	
		H	L	H	L	H	L	~		H	L	H	L	H	L
DDRAM Address (Upper 4bit)	80h	18 x 2 Characters (8x16 dots font)													
	90h														

DDRAM Address Map with 8x16 dots font

Note:

- *1. The mapping is based on Vertical Scroll Displacement Address=0.
- *2. Another 18x2(Character) Display Data RAM space is not showed. They could be displayed by adjusting the Vertical Scroll Displacement Address value.

5.6 Display Control Instructions

5.6.1 Basic Instruction Set

RE=0, basic instruction set

Instructions	Code										Function
	RS	R/W	DB7	DB6	DB5	DB4	DB3	DB2	DB1	DB0	
CLEAR	0	0	0	0	0	0	0	0	0	1	Fill DDRAM with "20h", and set DDRAM address counter (AC) to "00h"
HOME	0	0	0	0	0	0	0	0	1	X	Set DDRAM address counter (AC) to "00h" and put cursor to origin. DDRAM content no changed.
ENTRY MODE	0	0	0	0	0	0	0	1	I/D	S	Set cursor position and display shift when doing write or read operation I/D=1, cursor move right AC increased by 1 I/D=0, cursor move left, AC decreased by 1 S=1, toggle the shift of the entire display (based on I/D defined direction)
DISPLAY ON/OFF	0	0	0	0	0	0	1	D	C	B	D=1, display ON D=0, display OFF C=1, cursor ON C=0, cursor OFF B=1, blink ON B=0, blink OFF
CURSOR DISPLAY CONTROL	0	0	0	0	0	1	S/C	R/L	X	X	Cursor position and display shift control. DDRAM content no changed.
FUNCTION SET	0	0	0	0	1	DL	X	RE	X	X	DL=1, 8bit interface DL=0, 4bit interface RE=1, extended instruction RE=0; basic instruction
SET CGRAM ADDR	0	0	0	1	AC5	AC4	AC3	AC2	AC1	AC0	Set CGRAM address to address counter (AC) Make sure that in extended instruction SR=0 (scroll or RAM address selected)
SET DDRAM ADDR	0	0	AC7	AC6	AC5	AC4	AC3	AC2	AC1	AC0	Set DDRAM address to address counter (AC), where AC7 =1, AC6=0
READ BF & ADDR	0	1	BF	AC6	AC5	AC4	AC3	AC2	AC1	AC0	Read busy flag (BF) for completion of the internal operation, also read out the value of AC
WRITE RAM	1	0	D7	D6	D5	D4	D3	D2	D1	D0	Write data to internal RAM (DDRAM, CGRAM,GDRAM) For 16bit data, write two byte consecutively, high byte first, then low byte
READ RAM	1	1	D7	D6	D5	D4	D3	D2	D1	D0	Read data from internal RAM (DDRAM, CGRAM,GDRAM)

Note:

- *1. For the details of the Display Control Instructions, please refer to Sitronix ST7920 series datasheet.
- *2. RE is the selection byte of basic and extended instruction set. Each time altering the value of RE, it will remain. Thus, it is not necessary to set RE every time when using the same group of instruction set

5.6.2 Extended Instruction Set

RE=1, extended instruction set

Instructions	Code										Function
	RS	R/W	DB7	DB6	DB5	DB4	DB3	DB2	DB1	DB0	
SCROLL or RAM ADDR SELECT	0	0	0	0	0	0	0	0	1	SR	SR=1, enable vertical scroll position SR=0, enable CGRAM address (basic instruction)
REVERSE	0	0	0	0	0	0	0	1	R1	R0	Toggle 1 out of 4 line (in DDRAM) of the display to be reversed (initial value is R1 ,R0 = 0, 0
EXTENDED FUNCTION SET	0	0	0	0	1	DL	X	RE	G	0	DL=1, 8bit interface DL=0, 4bit interface RE=1, extended instruction RE=0; basic instruction G=1, graphics display ON G=0, graphics display OFF
SET SCROLL ADDR	0	0	0	1	AC5	AC4	AC3	AC2	AC1	AC0	Set the address of vertical scroll Make sure extended instruction SR=1, enable vertical scroll position.
SET GRAPHICS RAM ADDR	0	0	1	AC6	AC5	AC4	AC3	AC2	AC1	AC0	Set the GDRAM address to address counter (AC) Dual byte command should write consecutively First byte set the Vertical address AC6~AC0 Second byte set the Horizontal address AC3~AC0
	0	0	1	0	0	0	AC3	AC2	AC1	AC0	

Note:

*1. For the details of the Display Control Instructions, please refer to Sitronix ST7920 series datasheet.

*2. RE is the selection byte of basic and extended instruction set. Each time altering the value of RE, it will remain. Thus, it is not necessary to set RE every time when using the same group of instruction set

6. Design and Handling Precaution

1. The LCD panel is made by glass. Any mechanical shock (eg. dropping from high place) will damage the LCD module.
2. Do not add excessive force on the surface of the display, which may cause the Display color change abnormally.
3. The polarizer on the LCD is easily get scratched. If possible, do not remove the LCD protective film until the last step of installation.
4. Never attempt to disassemble or rework the LCD module.
5. Only Clean the LCD with Isopropyl Alcohol or Ethyl Alcohol. Other solvents (eg. water) may damage the LCD.
6. When mounting the LCD module, make sure that it is free from twisting, warping and distortion.
7. Ensure to provide enough space (with cushion) between case and LCD panel to prevent external force adding on it, or it may cause damage to the LCD or degrade the display result.
8. Only hold the LCD module by its side. Never hold LCD module by add force on the heat seal or TAB.
9. Never add force to component of the LCD module. It may cause invisible damage or degrade of the reliability.
10. LCD module could be easily damaged by static electricity. Be careful to maintain an optimum anti-static work environment to protect the LCD module.
11. When peeling off the protective film from LCD, static charge may cause abnormal display pattern. It is normal and will resume to normal in a short while.
12. Take care and prevent get hurt by the LCD panel sharp edge.
13. Never operate the LCD module exceed the absolute maximum ratings.
14. Keep the signal line as short as possible to prevent noisy signal applying to LCD module.
15. Never apply signal to the LCD module without power supply.
16. IC chip (eg. TAB or COG) is sensitive to the light. Strong lighting environment could possibly cause malfunction. Light sealing structure casing is recommend.
17. LCD module reliability may be reduced by temperature shock.
18. When storing the LCD module, avoid exposure to the direct sunlight, high humidity, high temperature or low temperature. They may damage or degrade the LCD module