

# LM3100

## SIMPLE SWITCHER® Synchronous 1MHz 1.5A Step-Down Voltage Regulator

### General Description

The LM3100 Synchronously Rectified Buck Converter features all functions needed to implement a highly efficient, cost effective buck regulator capable of supplying 1.5A to loads with voltages as low as 0.8V. Dual 40V N-Channel synchronous MOSFET switches allow for low external component thus reducing complexity and minimizing board space. The LM3100 is designed to work exceptionally well with ceramic and other very low ESR output capacitors. The Constant ON-Time (COT) regulation scheme requires no loop compensation, results in fast load transient response, and simplifies circuit implementation. Through the use of a unique design the regulator does not rely on output capacitor ESR for stability, as do most other COT regulators. The operating frequency remains nearly constant with line and load variations due to the inverse relationship between the input voltage and the on-time. The operating frequency can be externally programmed up to 1MHz. Protection features include  $V_{CC}$  under-voltage lockout, thermal shutdown and gate drive under-voltage lockout. The part is available in a thermally enhanced eTSSOP-20 package

### Features

- Input voltage range 4.5V - 36V
- 1.5A output current
- 0.8V,  $\pm 1.5\%$  reference
- Integrated 40V, dual N-Channel buck synchronous switches
- Low component count and small solution size
- No loop compensation required
- Ultra-fast transient response
- Stable with ceramic and other low ESR capacitors
- Programmable switching frequency up to 1MHz
- Max. duty cycle limited during start-up
- Valley current limit
- Precision Internal Reference for adjustable output voltage down to 0.8V
- Thermal shutdown
- Thermally enhanced eTSSOP-20 package

### Typical Applications

- 5VDC, 12VDC, 24VDC, 12VAC, and 24VAC systems
- Embedded Systems
- Industrial Controls
- Automotive Telematics and Body Electronics
- Point of Load Regulators
- Storage Systems
- Broadband Infrastructure
- Direct Conversion from 2/3/4 Cell Lithium Batteries Systems

### Typical Application

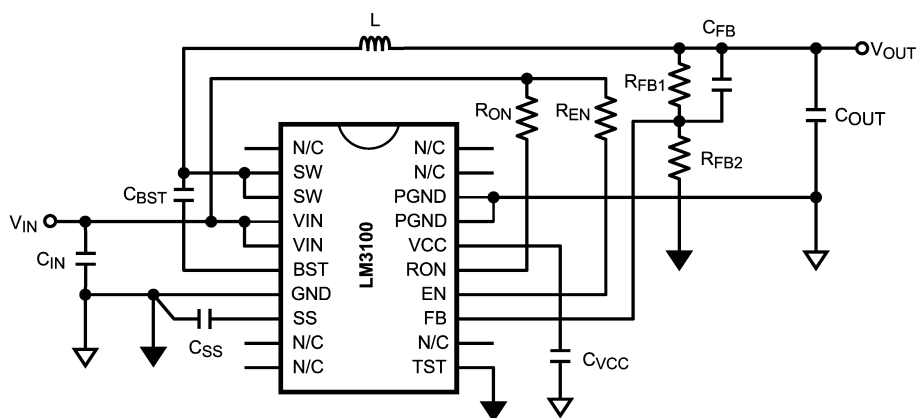

20174702

### Connection Diagram

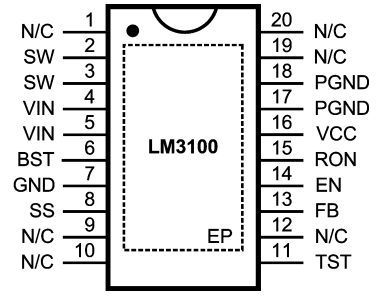

20-lead Plastic eTSSOP (MXA20A)

20174703

### Ordering Information

Order Number	Package Type	NSC Package Drawing	Supplied As
LM3100MH	Exposed Pad	MXA0020	73 units per Anti-Static Tube
LM3100MHX	TSSOP-20		2500 Units on Tape and Reel

## Pin Descriptions

Pin	Name	Description	Application Information
1,9,10,12,19,20	N/C	No Connection	These pins must be left unconnected.
2, 3	SW	Switching Node	Internally connected to the buck switch source. Connect to output inductor.
4, 5	VIN	Input supply voltage	Supply pin to the device. Nominal input range is 4.5V to 36V.
6	BST	Connection for bootstrap capacitor	Connect a 0.033 $\mu$ F capacitor from SW pin to this pin. An internal diode charges the capacitor during the high-side switch off-time.
7	GND	Analog Ground	Ground for all internal circuitry other than the synchronous switches.
8	SS	Soft-start	An internal 8 $\mu$ A current source charges an external capacitor to provide the soft- start function.
11	TST	Test mode enable pin	Force the device into test mode. Must be connected to ground for normal operation.
13	FB	Feedback	Internally connected to the regulation and over-voltage comparators. The regulation setting is 0.8V at this pin. Connect to feedback divider.
14	EN	Enable pin	Connect a voltage higher than 1.26V to enable the regulator.
15	RON	On-time Control	An external resistor from VIN to this pin sets the high-side switch on-time.
16	VCC	Start-up regulator Output	Nominally regulated to 6V. Connect a capacitor of not less than 680nF between VCC and GND for stable operation.
17, 18	PGND	Power Ground	Synchronous rectifier MOSFET source connection. Tie to power ground plane.
DAP	EP	Exposed Pad	Thermal connection pad, connect to GND.

**Absolute Maximum Ratings** (Note 1)

If Military/Aerospace specified devices are required, please contact the National Semiconductor Sales Office/Distributors for availability and specifications.

V <sub>IN</sub> , R <sub>ON</sub> to GND	-0.3V to 40V
SW to GND	-0.3V to 40V
SW to GND (Transient)	-2V (< 100ns)
V <sub>IN</sub> to SW	-0.3V to 40V
BST to SW	-0.3V to 7V
All Other Inputs to GND	-0.3V to 7V

## ESD Rating (Note 2)

Human Body Model	±2kV
Storage Temperature Range	-65°C to +150°C
Junction Temperature (T <sub>J</sub> )	150°C

**Operating Ratings** (Note 1)

Supply Voltage Range (V <sub>IN</sub> )	4.5V to 36V
Junction Temperature Range (T <sub>J</sub> )	-40°C to +125°C
Thermal Resistance (θ <sub>JC</sub> ) (Note 3)	6.5°C/W

**Electrical Characteristics** Specifications with standard type are for T<sub>J</sub> = 25°C only; limits in boldface type apply over the full Operating Junction Temperature (T<sub>J</sub>) range. Minimum and Maximum limits are guaranteed through test, design, or statistical correlation. Typical values represent the most likely parametric norm at T<sub>J</sub> = 25°C, and are provided for reference purposes only. Unless otherwise stated the following conditions apply: V<sub>IN</sub> = 18V, V<sub>OUT</sub> = 3.3V.

Symbol	Parameter	Conditions	Min	Typ	Max	Units
<b>Start-Up Regulator, V<sub>CC</sub></b>						
V <sub>CC</sub>	V <sub>CC</sub> output voltage	C <sub>CC</sub> = 680nF, no load	<b>5.0</b>	6.0	<b>7.2</b>	V
V <sub>IN</sub> - V <sub>CC</sub>	V <sub>IN</sub> - V <sub>CC</sub> dropout voltage	I <sub>CC</sub> = 2mA		50	<b>140</b>	mV
		I <sub>CC</sub> = 20mA		350	<b>570</b>	
I <sub>VCC</sub>	V <sub>CC</sub> current limit (Note 4)	V <sub>CC</sub> = 0V	<b>40</b>	65		mA
V <sub>CC-UVLO</sub>	V <sub>CC</sub> under-voltage lockout threshold (UVLO)	V <sub>IN</sub> increasing	<b>3.6</b>	3.75	<b>3.85</b>	V
V <sub>CC-UVLO-HYS</sub>	V <sub>CC</sub> UVLO hysteresis	V <sub>IN</sub> decreasing		130		mV
t <sub>VCC-UVLO-D</sub>	V <sub>CC</sub> UVLO filter delay			3		μs
I <sub>IN</sub>	I <sub>IN</sub> operating current	No switching, V <sub>FB</sub> = 1V		0.7	<b>1</b>	mA
I <sub>IN-SD</sub>	I <sub>IN</sub> operating current, Device shutdown	V <sub>EN</sub> = 0V		17	<b>30</b>	μA
<b>Switching Characteristics</b>						
R <sub>DS-UP-ON</sub>	Main MOSFET R <sub>ds(on)</sub>			0.18	<b>0.35</b>	Ω
R <sub>DS-DN-ON</sub>	Syn. MOSFET R <sub>ds(on)</sub>			0.11	<b>0.2</b>	Ω
V <sub>G-UVLO</sub>	Gate drive voltage UVLO	V <sub>BST</sub> - V <sub>SW</sub> increasing		3.3	<b>4</b>	V
<b>Soft-start</b>						
I <sub>SS</sub>	SS pin source current	V <sub>SS</sub> = 0.5V	<b>6</b>	8	<b>9.8</b>	μA
<b>Current Limit</b>						
I <sub>CL</sub>	Syn. MOSFET current limit threshold			1.9		A
<b>ON/OFF Timer</b>						
t <sub>ON</sub>	ON timer pulse width	V <sub>IN</sub> = 10V, R <sub>ON</sub> = 100 kΩ		1.38		μs
		V <sub>IN</sub> = 30V, R <sub>ON</sub> = 100 kΩ		0.47		
t <sub>ON-MIN</sub>	ON timer minimum pulse width			200		ns
t <sub>OFF</sub>	OFF timer pulse width			260		ns
<b>Enable Input</b>						
V <sub>EN</sub>	EN Pin input threshold	V <sub>EN</sub> rising	<b>1.236</b>	1.26	<b>1.285</b>	V
V <sub>EN-HYS</sub>	Enable threshold hysteresis	V <sub>EN</sub> falling		90		mV
<b>Regulation and Over-Voltage Comparator</b>						
V <sub>FB</sub>	In-regulation feedback voltage	V <sub>SS</sub> ≥ 0.8V T <sub>J</sub> = -40°C to +125°C	<b>0.784</b>	0.8	<b>0.816</b>	V
		V <sub>SS</sub> ≥ 0.8V T <sub>J</sub> = 0°C to +125°C	<b>0.788</b>		<b>0.812</b>	
V <sub>FB-OV</sub>	Feedback over-voltage threshold		<b>0.894</b>	0.920	<b>0.940</b>	V
I <sub>FB</sub>				5	<b>100</b>	nA
<b>Thermal Shutdown</b>						
T <sub>SD</sub>	Thermal shutdown temperature	T <sub>J</sub> rising		165		°C

**Electrical Characteristics** Specifications with standard type are for  $T_J = 25^\circ\text{C}$  only; limits in boldface type apply over the full Operating Junction Temperature ( $T_J$ ) range. Minimum and Maximum limits are guaranteed through test, design, or statistical correlation. Typical values represent the most likely parametric norm at  $T_J = 25^\circ\text{C}$ , and are provided for reference purposes only. Unless otherwise stated the following conditions apply:  $V_{IN} = 18\text{V}$ ,  $V_{OUT} = 3.3\text{V}$ . (Continued)

Symbol	Parameter	Conditions	Min	Typ	Max	Units
$T_{SD-HYS}$	Thermal shutdown temperature hysteresis	$T_J$ falling		20		$^\circ\text{C}$

**Note 1:** Absolute Maximum Ratings are limits beyond which damage to the device may occur. Operating Ratings are conditions under which operation of the device is intended to be functional. For guaranteed specifications and test conditions, see the Electrical Characteristics.

**Note 2:** The human body model is a 100pF capacitor discharged through a 1.5k $\Omega$  resistor into each pin.

**Note 3:**  $\theta_{JC}$  measurements are performed in general accordance with Mil-Std 883B, Method 1012.1 and utilizes the copper heat sink technique. Copper Heat Sink @ 60 $^\circ\text{C}$ .

**Note 4:**  $V_{CC}$  provides self bias for the internal gate drive and control circuits. Device thermal limitations limit external loading.

**Typical Performance Characteristics** All curves taken at  $V_{IN} = 18V$  with configuration in typical application circuit for  $V_{OUT} = 3.3V$  shown in this datasheet.  $T_A = 25^\circ C$ , unless otherwise specified.

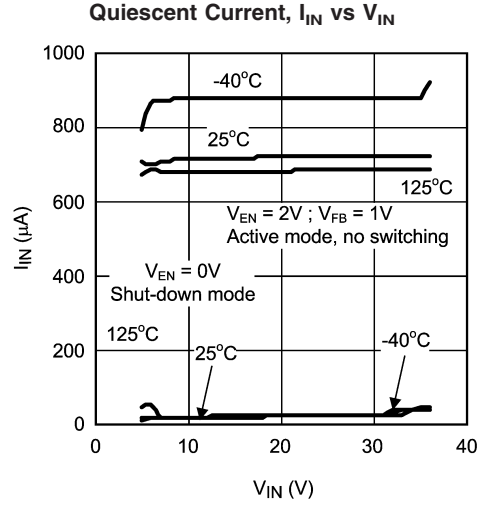

20174718

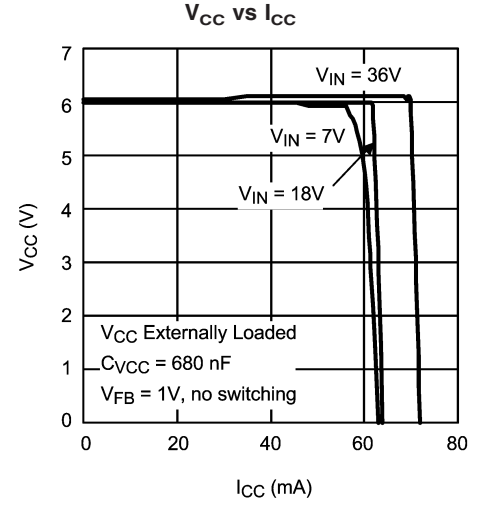

20174719

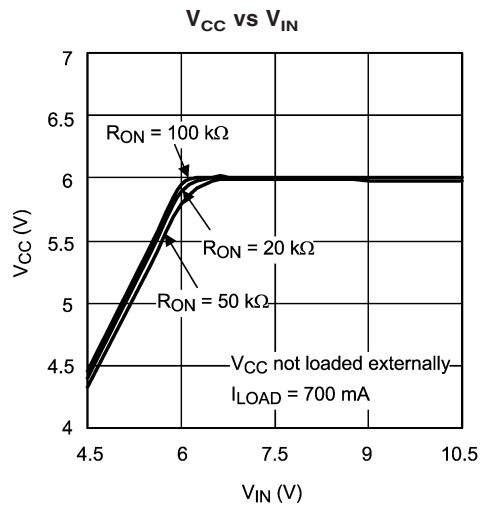

20174720

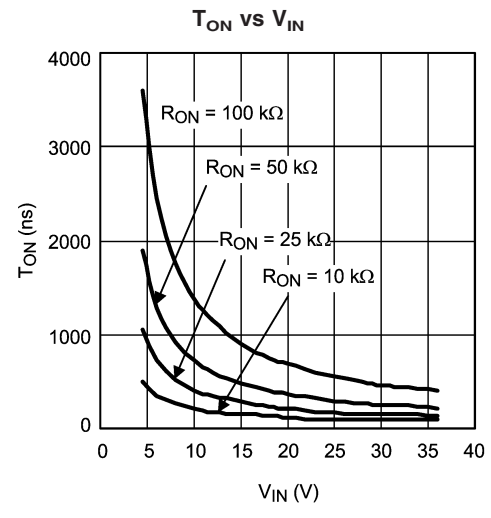

20174721

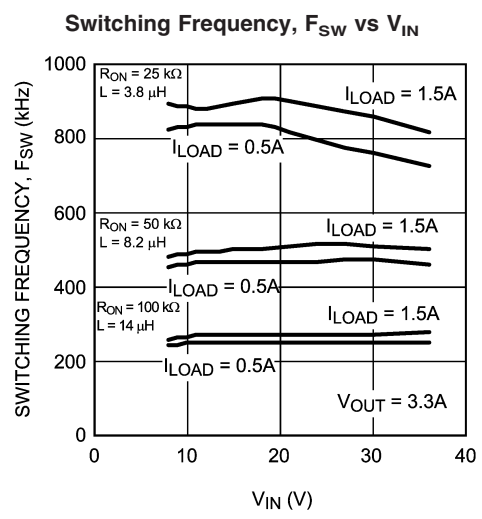

20174722

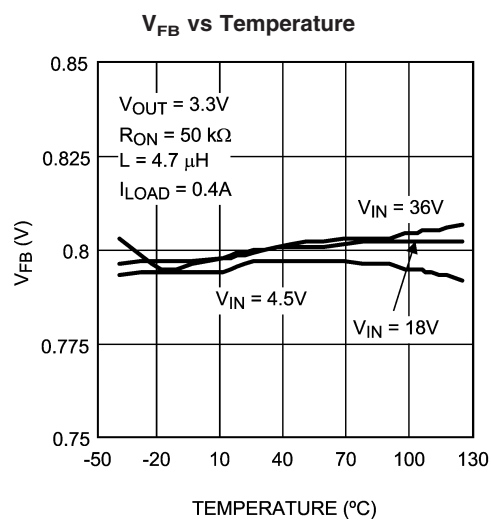

20174723

**Typical Performance Characteristics** All curves taken at  $V_{IN} = 18V$  with configuration in typical application circuit for  $V_{OUT} = 3.3V$  shown in this datasheet.  $T_A = 25^\circ C$ , unless otherwise specified. (Continued)

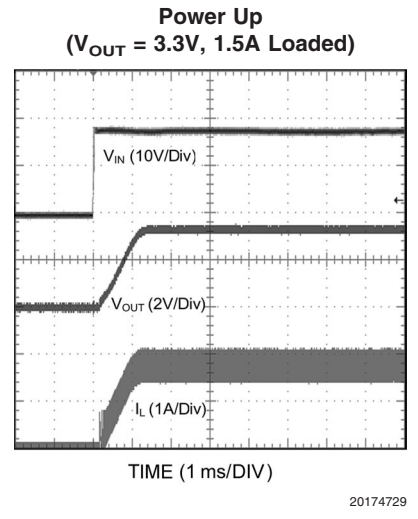
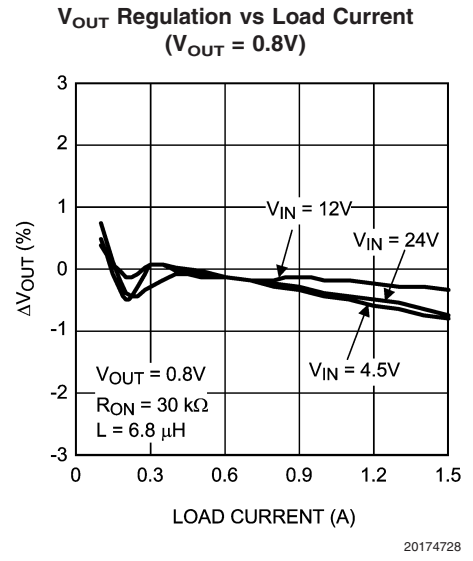
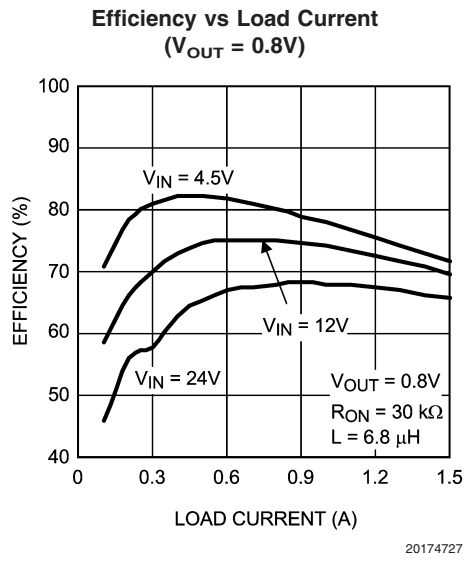
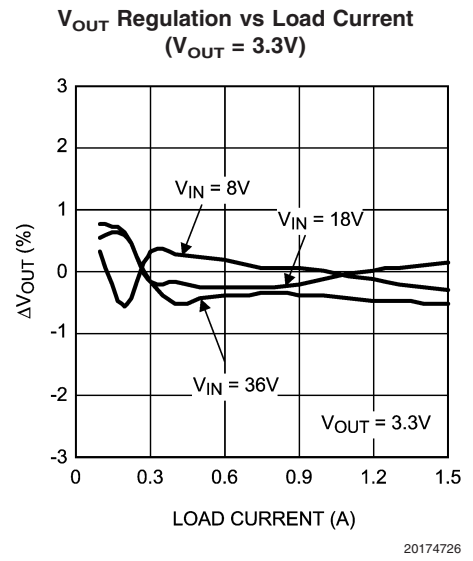
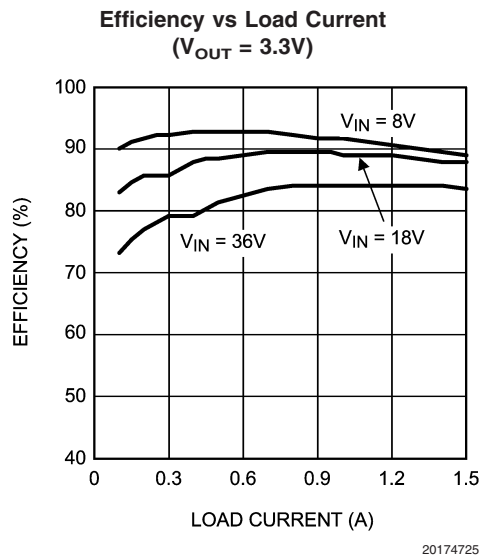
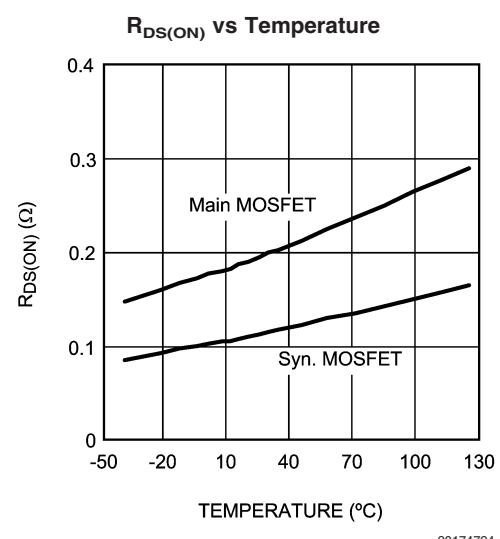

**Typical Performance Characteristics** All curves taken at  $V_{IN} = 18V$  with configuration in typical application circuit for  $V_{OUT} = 3.3V$  shown in this datasheet.  $T_A = 25^{\circ}C$ , unless otherwise specified. (Continued)

**Enable Transient**  
( $V_{OUT} = 3.3V, 1.5A$  Loaded)

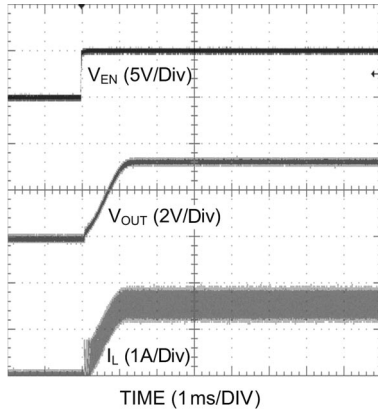

20174730

**Shutdown Transient**  
( $V_{OUT} = 3.3V, 1.5A$  Loaded)

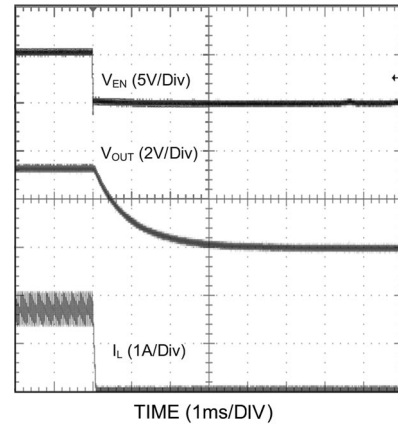

20174731

**Continuous Mode Operation**  
( $V_{OUT} = 3.3V, 1.5A$  Loaded)

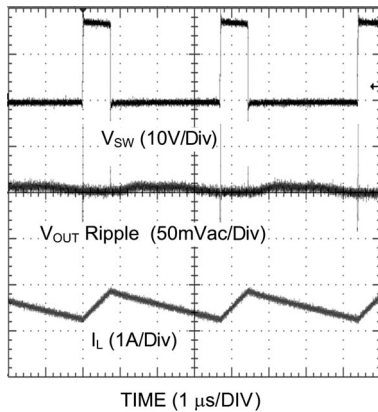

20174732

**Discontinuous Mode Operation**  
( $V_{OUT} = 3.3V, 1.5A$  Loaded)

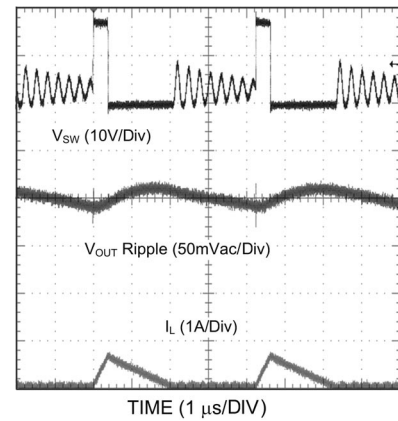

20174733

**CCM to DCM Transition**  
( $V_{OUT} = 3.3V, 0.15A - 1.5A$  Load)

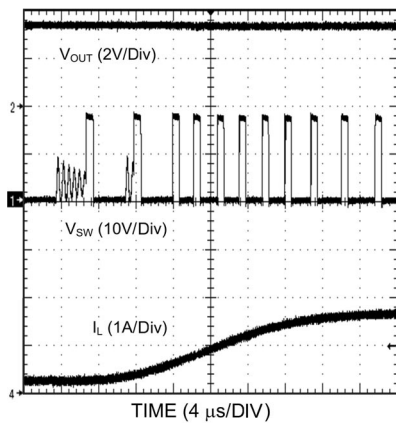

20174734

**Load Transient**  
( $V_{OUT} = 3.3V, 0.15A - 1.5A$  Load, Current slew-rate:  $2.5A/\mu s$ )

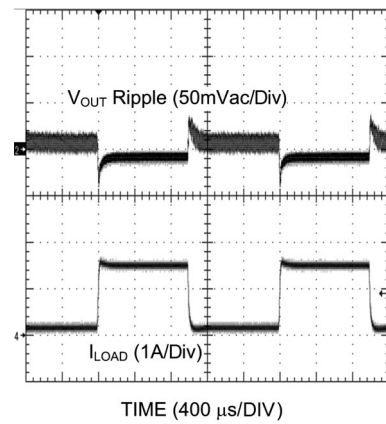

20174735



### Simplified Functional Block Diagram

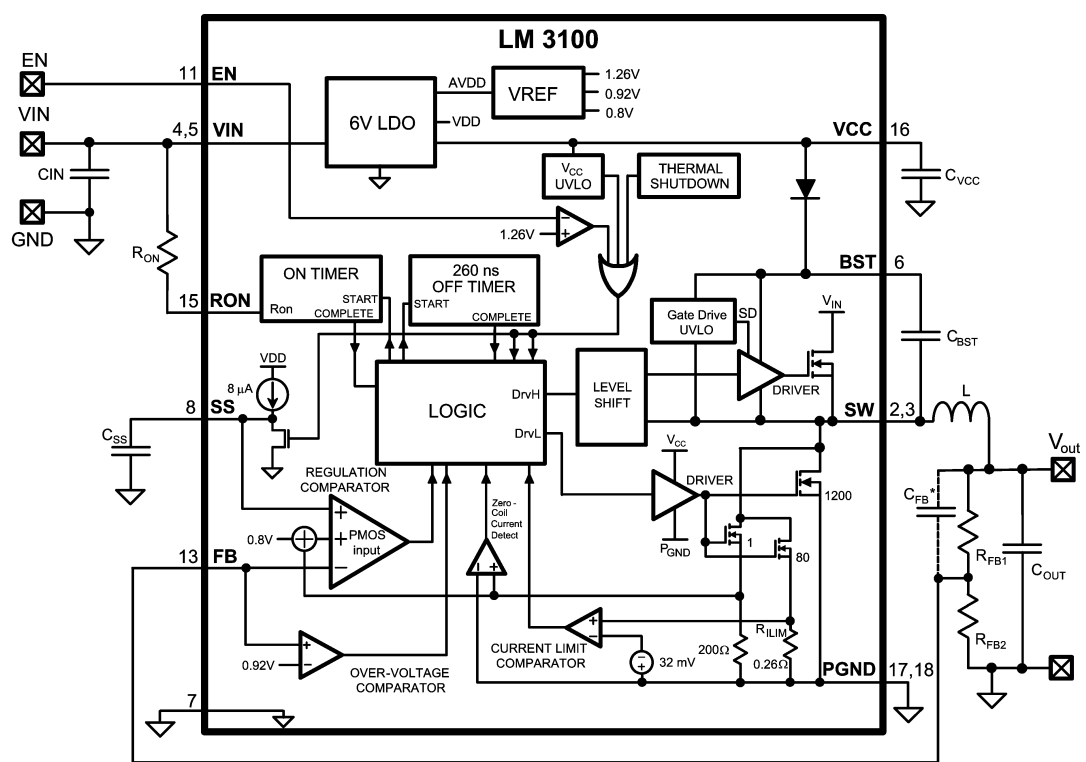

\*optional  
20174701

## Functional Description

The LM3100 Step Down Switching Regulator features all functions needed to implement a cost effective, efficient buck power converter capable of supplying 1.5A to a load. This voltage regulator contains Dual 40V N-Channel buck synchronous switches and is available in a thermally enhanced eTSSOP-20 package. The Constant ON-Time (COT) regulation scheme requires no loop compensation, results in fast load transient response, and simplifies circuit implementation. It will work correctly even with an all ceramic output capacitor network and does not rely on the output capacitor's ESR for stability. The operating frequency remains constant with line and load variations due to the inverse relationship between the input voltage and the on-time. The valley current limit detection circuit, internally set at 1.9A, inhibits the high-side switch until the inductor current level subsides. Please refer to the functional block diagram with a typical application circuit.

The LM3100 can be applied in numerous applications and can operate efficiently from inputs as high as 36V. Protection features include: Thermal shutdown,  $V_{CC}$  under-voltage lockout, gate drive under-voltage lockout.

## Hysteretic Control Circuit Overview

The LM3100 buck DC-DC regulator employs a control scheme in which the high-side switch on-time varies inversely with the line voltage ( $V_{IN}$ ). Control is based on a comparator and the one-shot on-timer, with the output voltage feedback (FB) compared with an internal reference of 0.8V. If the FB level is below the reference the buck switch is turned on for a fixed time determined by the input voltage and a programming resistor ( $R_{ON}$ ). Following the on-time, the switch remains off for a minimum of 260ns. If FB is below the reference at that time the switch turns on again for another on-time period. The switching will continue until regulation is achieved.

The regulator will operate in discontinuous conduction mode at light load currents, and continuous conduction mode with heavy load current. In discontinuous conduction mode (DCM), current through the output inductor starts at zero and ramps up to a peak during the on-time, then ramps back to zero before the end of the off-time. The next on-time period starts when the voltage at FB falls below the internal reference. Until then the inductor current remains zero and the load is supplied entirely by the output capacitor. In this mode the operating frequency is lower than in continuous conduction mode, and varies with load current. Conversion efficiency is maintained since the switching losses are reduced with the reduction in load and switching frequency. The discontinuous operating frequency can be calculated approximately as follows:

$$F_s = \frac{V_{OUT} (V_{IN} - 1) \times L \times 1.18 \times 10^{20} \times I_{OUT}}{(V_{IN} - V_{OUT}) \times R_{ON}^2} \quad (1)$$

where  $R_L$  = the load resistance

In continuous conduction mode (CCM), current always flows through the inductor and never reaches zero during the off-time. In this mode, the operating frequency remains relatively constant with load and line variations. The CCM operating frequency can be calculated approximately as follows:

$$F_s = \frac{V_{OUT}}{1.3 \times 10^{-10} \times R_{ON}} \quad (2)$$

The output voltage is set by two external resistors ( $R_{FB1}$ ,  $R_{FB2}$ ). The regulated output voltage is calculated as follows:

$$V_{OUT} = 0.8V \times (R_{FB1} + R_{FB2})/R_{FB2} \quad (3)$$

## Start-up Regulator ( $V_{CC}$ )

The start-up regulator is integrated within LM3100. The input pin ( $V_{IN}$ ) can be connected directly to line voltage up to 36V, with transient capability to 40V. The  $V_{CC}$  output regulates at 6V, and is current limited to 65 mA. Upon power up, the regulator sources current into the external capacitor at  $V_{CC}$  ( $C_{VCC}$ ).  $C_{VCC}$  must be at least 680nF for stability. When the voltage on the VCC pin reaches the under-voltage lockout threshold of 3.75V, the buck switch is enabled and the Soft-start pin is released to allow the soft-start capacitor ( $C_{SS}$ ) to charge.

The minimum input voltage is determined by the dropout voltage of  $V_{CC}$ , and the  $V_{CC}$  UVLO falling threshold ( $\approx 3.7$  V). If  $V_{IN}$  is less than  $\approx 4.0$ V, the  $V_{CC}$  UVLO activates to shut off the output.

## Regulation Comparator

The feedback voltage at FB is compared to the internal reference voltage of 0.8V. In normal operation (the output voltage is regulated), an on-time period is initiated when the voltage at FB falls below 0.8V. The buck switch stays on for the on-time, causing the FB voltage to rise above 0.8V. After the on-time period, the buck switch stays off until the FB voltage falls below 0.8V. Bias current at the FB pin is nominally 100 nA.

## Over-Voltage Comparator

The voltage at FB is compared to an internal 0.92V reference. If the voltage at FB rises above 0.92V the on-time pulse is immediately terminated. This condition can occur if the input voltage, or the output load, changes suddenly. Once the OVP is activated, the buck switch remains off until the voltage at FB pin falls below 0.92V. The low side switch will stay on to discharge the inductor energy and until the inductor current decays to zero. The low side switch will be turned off.

## ON-Time Timer, Shutdown

The LM3100 main switch is determined by the  $R_{ON}$  resistor and the input voltage ( $V_{IN}$ ), and is calculated from:

$$t_{ON} = \frac{1.3 \times 10^{-10} \times R_{ON}}{V_{IN}} \quad (4)$$

The inverse relationship with  $V_{IN}$  results in a nearly constant frequency as  $V_{IN}$  is varied.  $R_{ON}$  should be selected for a minimum on-time (at maximum  $V_{IN}$ ) greater than 200 ns for proper current limit operation. This requirement limits the maximum frequency for each application, depending on  $V_{IN}$  and  $V_{OUT}$ , calculated from the following:

## ON-Time Timer, Shutdown (Continued)

$$F_{MAX} = \frac{V_{OUT}}{V_{IN(MAX)} \times 200 \text{ ns}} \quad (5)$$

The LM3100 can be remotely shut down by taking the EN pin below 1.1V. Refer to Figure 1. In this mode the SS pin is internally grounded, the on-timer is disabled, and bias currents are reduced. Releasing the EN pin allows normal operation to resume. The voltage at the EN pin is between 1.5V and 3.0V, depending on  $V_{IN}$  and the pull-up resistor.

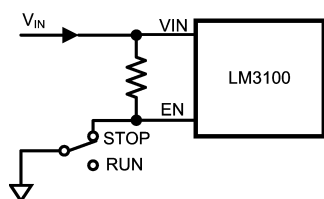

20174704

FIGURE 1. Shutdown Implementation

## Current Limit

Current limit detection occurs during the off-time by monitoring the re-circulating current through the low-side synchro-

nous switch. Referring to Functional Block Diagram, when the buck switch is turned off, inductor current flows through the load, into PGND, and through the internal low-side synchronous switch. If that current exceeds 1.9A the current limit comparator toggles, forcing a delay to the start of the next on-time period. The next cycle starts when the re-circulating current falls back below 1.9A and the voltage at FB is below 0.8V. The inductor current is monitored during the low-side switch on-time. As long as the overload condition persists and the inductor current exceeds 1.9A, the high-side switch will remain inhibited. The operating frequency is lower during an over-current due to longer than normal off-times.

Figure 2 illustrates the inductor current waveform. During normal operation the load current is low, the average of the ripple waveform. When an overload occurs the current ratchets up until it exceeds 1.9A. During the Current Limited portion of Figure 2, the current ramps down to 1.9A during each off-time, initiating the next on-time (assuming the voltage at FB is  $<0.8V$ ). During each on-time the current ramps up an amount equal to:

$$\Delta I = \frac{(V_{IN} - V_{OUT}) \times t_{ON}}{L} \quad (6)$$

During this time the LM3100 is in a constant current mode, with an average load current ( $I_{OCL}$ ) equal to  $1.9A + \Delta I/2$ .

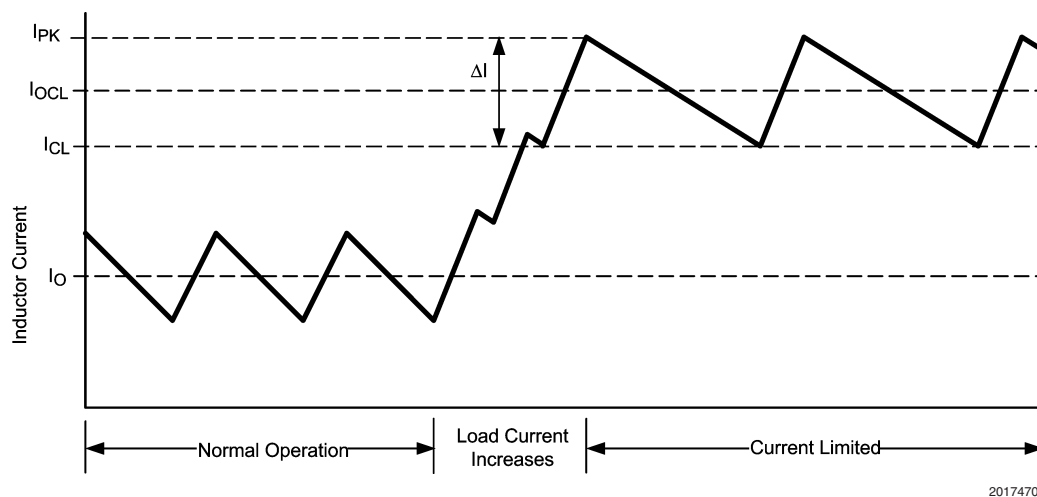

20174705

FIGURE 2. Inductor Current - Current Limit Operation

## N - Channel Buck Switch and Driver

The LM3100 integrates an N-Channel buck (high-side) switch and associated floating high voltage gate driver. The gate drive circuit works in conjunction with an external bootstrap capacitor and an internal high voltage diode. A 33 nF capacitor ( $C_{BST}$ ) connected between BST and SW pins provides voltage to the high-side driver during the buck switch on-time. During each off-time, the SW pin falls to approximately -1V and  $C_{BST}$  charges from the  $V_{CC}$  supply through the internal diode. The minimum off-time of 260ns ensures adequate time each cycle to recharge the bootstrap capacitor.

### Softstart

The soft-start feature allows the converter to gradually reach a steady state operating point, thereby reducing start-up stresses and current surges. Upon turn-on, after  $V_{CC}$  reaches the under-voltage threshold, an internal 8 $\mu$ A current source charges up the external capacitor at the SS pin. The ramping voltage at SS (and the non-inverting input of the regulation comparator) ramps up the output voltage in a controlled manner.

An internal switch grounds the SS pin if  $V_{CC}$  is below the under-voltage lockout threshold, if a thermal shutdown occurs, or if the EN pin is grounded. Using an externally controlled switch, the output voltage can be shut off by taking the SS pin to ground. Releasing the switch allows the SS pin to ramp up, and the output voltage to return to normal. The shut-down configuration is shown in Figure 3.

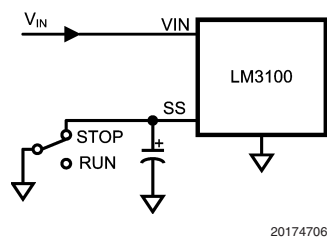

20174706

FIGURE 3. Alternate Shutdown Implementation

### Thermal Protection

The LM3100 should be operated so the junction temperature does not exceed the maximum limit. An internal Thermal Shutdown circuit, which activates (typically) at 165°C, takes the controller to a low power reset state by disabling the buck switch and the on-timer, and grounding the Softstart pin. This feature helps prevent catastrophic failures from accidental device overheating. When the junction temperature falls back below 145°C (typical hysteresis = 20°C), the Softstart pin is released and normal operation resumes.

### Applications Information

#### EXTERNAL COMPONENTS

The following guidelines can be used to select the external components.

$R_{FB1}$  and  $R_{FB2}$ : The ratio of these resistors is calculated from:

$$R_{FB1}/R_{FB2} = (V_{OUT}/0.8V) - 1$$

$R_{FB1}$  and  $R_{FB2}$  should be chosen from standard value resistors in the range of 1.0 k $\Omega$  - 10 k $\Omega$  which satisfy the above ratio.

For  $V_{OUT} = 0.8V$ , the FB pin can be connected to the output directly. However, the converter operation needs a minimum inductor current ripple to maintain good regulation when no load is connected. This minimum load is about 10  $\mu$ A and can be implemented by adding a pre-load resistor to the output.

$R_{ON}$ : The minimum value for  $R_{ON}$  is calculated from:

$$R_{ON} \geq \frac{200 \text{ ns} \times (V_{INMAX})}{1.3 \times 10^{-10}}$$

Equation 1 can be used to select  $R_{ON}$  if a specific frequency is desired as long as the above limitation is met.

**L**: The main parameter effected by the inductor is the output current ripple amplitude ( $I_{OR}$ ). The maximum allowable ( $I_{OR}$ ) must be determined at both the minimum and maximum nominal load currents. At minimum load current, the lower peak must not reach 0 mA. At maximum load current, the upper peak must not exceed the current limit threshold (1.9A). The allowable ripple current is calculated from the following equations:

$$I_{OR(MAX1)} = 2 \times I_{O(min)}$$

or

$$I_{OR(MAX2)} = 2 \times (1.9A - I_{O(max)})$$

The lesser of the two ripple amplitudes calculated above is then used in the following equation:

$$L = \frac{V_{OUT} \times (V_{IN} - V_{OUT})}{I_{OR} \times F_s \times V_{IN}} \quad (7)$$

where  $V_{IN}$  is the maximum input voltage and  $F_s$  is determined from equation 1. This provides a value for L. The next larger standard value should be used. L should be rated for the  $I_{PK}$  current level shown in Figure 2.

#### Inductor Selector for $V_{OUT} = 3.3V$

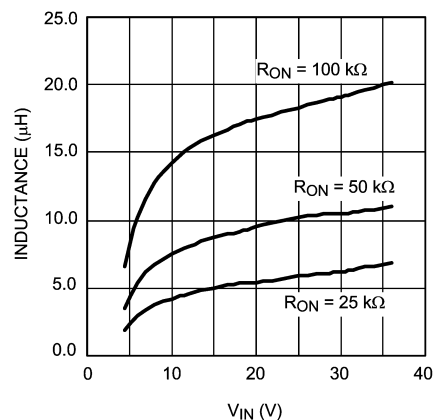

20174736

## Applications Information (Continued)

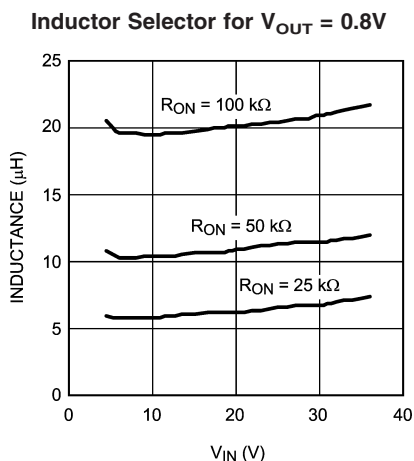

20174737

**$C_{VCC}$ :** The capacitor on the  $V_{CC}$  output provides not only noise filtering and stability, but also prevents false triggering of the  $V_{CC}$  UVLO at the buck switch on/off transitions. For this reason,  $C_{VCC}$  should be no smaller than 680 nF for stability, and should be a good quality, low ESR, ceramic capacitor.

**$C_O$  and  $C_{O3}$ :**  $C_O$  should generally be no smaller than 10  $\mu F$ . Experimentation is usually necessary to determine the minimum value for  $C_O$ , as the nature of the load may require a larger value. A load which creates significant transients requires a larger value for  $C_O$  than a fixed load.

$C_{O3}$  is a small value ceramic capacitor to further suppress high frequency noise at  $V_{OUT}$ . A 47nF is recommended, located close to the LM3100.

**$C_{IN}$  and  $C_{IN3}$ :**  $C_{IN}$ 's purpose is to supply most of the switch current during the on-time, and limit the voltage ripple at  $V_{IN}$ , on the assumption that the voltage source feeding  $V_{IN}$  has an output impedance greater than zero. If the source's dynamic impedance is high (effectively a current source), it supplies the average input current, but not the ripple current.

At maximum load current, when the buck switch turns on, the current into  $V_{IN}$  suddenly increases to the lower peak of the inductor's ripple current, ramps up to the peak value, then drop to zero at turn-off. The average current during the on-time is the load current. For a worst case calculation,  $C_{IN}$  must supply this average load current during the maximum on-time.  $C_{IN}$  is calculated from:

$$C_{IN} = \frac{I_O \times t_{ON}}{\Delta V} \quad (8)$$

where  $I_O$  is the load current,  $t_{ON}$  is the maximum on-time, and  $\Delta V$  is the allowable ripple voltage at  $V_{IN}$ .

$C_{IN3}$ 's purpose is to help avoid transients and ringing due to long lead inductance at  $V_{IN}$ . A low ESR, 0.1 $\mu F$  ceramic chip capacitor is recommended, located close to the LM3100.

**$C_{BST}$ :** The recommended value for  $C_{BST}$  is 33 nF. A high quality ceramic capacitor with low ESR is recommended as  $C_{BST}$  supplies a surge current to charge the buck switch gate at turn-on. A low ESR also helps ensure a complete recharge during each off-time.

**$C_{SS}$ :** The capacitor at the SS pin determines the soft-start time, i.e. the time for the reference voltage at the regulation comparator, and the output voltage, to reach their final value. The time is determined from the following:

$$t_{SS} = \frac{C_{SS} \times 0.8V}{8 \mu A}$$

**$C_{FB}$ :** If output voltage is higher than 1.6V, this feedback cap is needed for Discontinuous Conduction Mode to improve the output ripple performance, the recommended value for  $C_{FB}$  is 10 nF.

### PC BOARD LAYOUT

The LM3100 regulation, over-voltage, and current limit comparators are very fast, and will respond to short duration noise pulses. Layout considerations are therefore critical for optimum performance. The layout must be as neat and compact as possible, and all of the components must be as close as possible to their associated pins. Refer to the functional block diagram, the loop formed by  $C_{IN}$ , the high and low-side switches internal to the IC, and the PGND pin should be as small as possible. The PGND connection to  $C_{IN}$  should be as short and direct as possible. There should be several vias connecting the  $C_{IN}$  ground terminal to the ground plane placed as close to the capacitor as possible. The boost capacitor should be connected as close to the SW and BST pins as possible. The feedback divider resistors and the  $C_{FB}$  capacitor should be located close to the FB pin. A long trace run from the top of the divider to the output is generally acceptable since this is a low impedance node. Ground the bottom of the divider directly to the GND (pin 7). The output capacitor,  $C_{OUT}$ , should be connected close to the load and tied directly into the ground plane. The inductor should connect close to the SW pin with as short a trace as possible to help reduce the potential for EMI (electromagnetic interference) generation.

If it is expected that the internal dissipation of the LM3100 will produce excessive junction temperatures during normal operation, good use of the PC board's ground plane can help considerably to dissipate heat. The exposed pad on the bottom of the IC package can be soldered to a ground plane and that plane should extend out from beneath the IC to help dissipate the heat. The exposed pad is internally connected to the IC substrate. Additionally the use of wide PC board traces, where possible, can help conduct heat away from the IC. Using numerous vias to connect the die attach pad to an internal ground plane is a good practice. Judicious positioning of the PC board within the end product, along with the use of any available air flow (forced or natural convection) can help reduce the junction temperature.

### Applications Information (Continued)

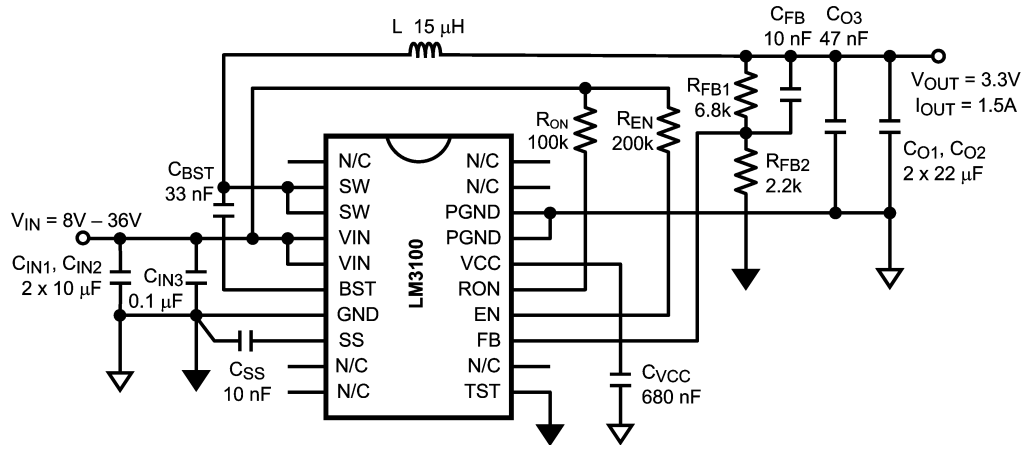

Typical Application Schematic for  $V_{OUT} = 3.3V$

20174716

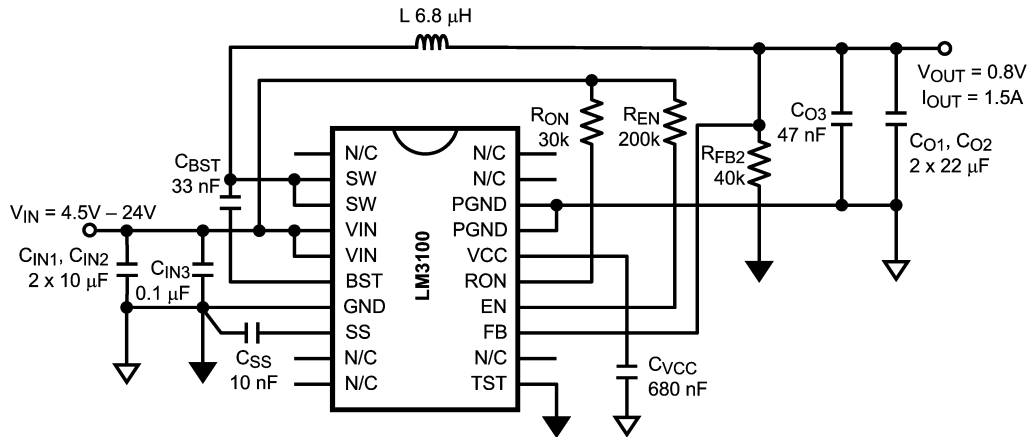

Typical Application Schematic for  $V_{OUT} = 0.8V$

20174717

## Physical Dimensions inches (millimeters) unless otherwise noted

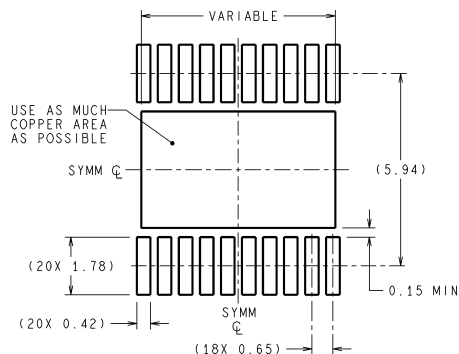
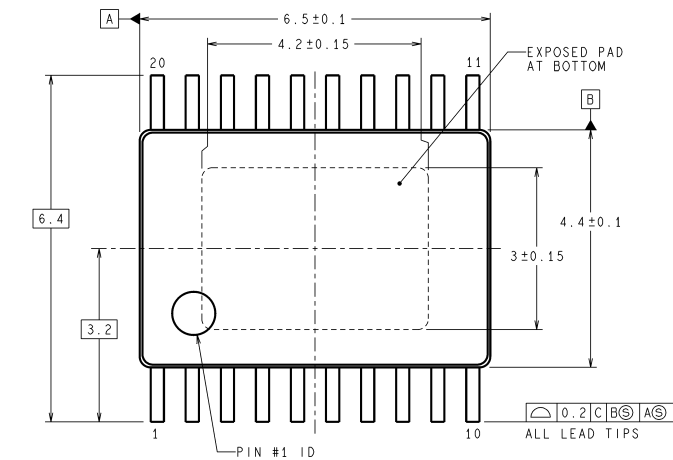

DIMENSIONS ARE IN MILLIMETERS  
DIMENSIONS IN ( ) FOR REFERENCE ONLY

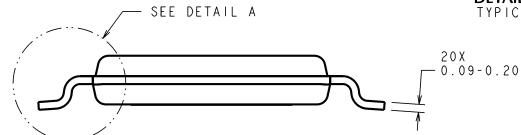
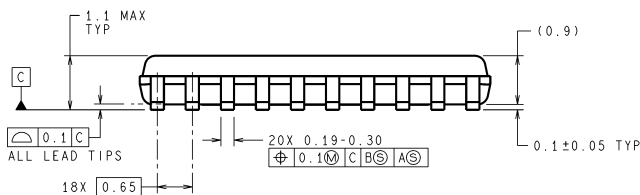
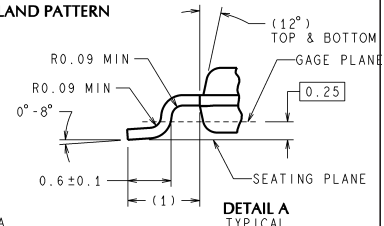

MXA20A (Rev B)

### 20-Lead Plastic eTSSOP Package NS Package Number MXA20A

National does not assume any responsibility for use of any circuitry described, no circuit patent licenses are implied and National reserves the right at any time without notice to change said circuitry and specifications.

For the most current product information visit us at [www.national.com](http://www.national.com).

#### LIFE SUPPORT POLICY

NATIONAL'S PRODUCTS ARE NOT AUTHORIZED FOR USE AS CRITICAL COMPONENTS IN LIFE SUPPORT DEVICES OR SYSTEMS WITHOUT THE EXPRESS WRITTEN APPROVAL OF THE PRESIDENT AND GENERAL COUNSEL OF NATIONAL SEMICONDUCTOR CORPORATION. As used herein:

1. Life support devices or systems are devices or systems which, (a) are intended for surgical implant into the body, or (b) support or sustain life, and whose failure to perform when properly used in accordance with instructions for use provided in the labeling, can be reasonably expected to result in a significant injury to the user.
2. A critical component is any component of a life support device or system whose failure to perform can be reasonably expected to cause the failure of the life support device or system, or to affect its safety or effectiveness.

#### BANNED SUBSTANCE COMPLIANCE

National Semiconductor follows the provisions of the Product Stewardship Guide for Customers (CSP-9-111C2) and Banned Substances and Materials of Interest Specification (CSP-9-111S2) for regulatory environmental compliance. Details may be found at: [www.national.com/quality/green](http://www.national.com/quality/green).

Lead free products are RoHS compliant.

 **National Semiconductor**  
Americas Customer  
Support Center  
Email: [new.feedback@nsc.com](mailto:new.feedback@nsc.com)  
Tel: 1-800-272-9959

**National Semiconductor**  
Europe Customer Support Center  
Fax: +49 (0) 180-530 85 86  
Email: [europe.support@nsc.com](mailto:europe.support@nsc.com)  
Deutsch Tel: +49 (0) 69 9508 6208  
English Tel: +44 (0) 870 24 0 2171  
Français Tel: +33 (0) 1 41 91 8790

**National Semiconductor**  
Asia Pacific Customer  
Support Center  
Email: [ap.support@nsc.com](mailto:ap.support@nsc.com)

**National Semiconductor**  
Japan Customer Support Center  
Fax: 81-3-5639-7507  
Email: [jpn.feedback@nsc.com](mailto:jpn.feedback@nsc.com)  
Tel: 81-3-5639-7560

[www.national.com](http://www.national.com)

[www.DataSheet4U.com](http://www.DataSheet4U.com)