

LM216/LM316, LM216A/LM316A Operational Amplifiers

General Description

These devices are precision, high input impedance operational amplifiers designed for applications requiring extremely low input-current errors. They use supergain transistors in a Darlington input stage to get input bias currents that are equal to high-quality FET amplifiers—even in limited temperature range operation. The low input current is, however, obtained with some sacrifice to offset voltage, offset voltage drift and noise when compared to the non-Darlington LM112 series. Noteworthy specifications include:

- Guaranteed bias currents as low as 50 pA
- Maximum offset currents down to 15 pA
- Operates from supplies of $\pm 3V$ to $\pm 20V$
- Supply current only 300 μA at $\pm 20V$

These operational amplifiers are internally frequency compensated and have provisions for offset balancing with a single external potentiometer.

Further, unlike most other internally compensated amplifiers, the MOS compensation capacitor is protected to prevent catastrophic failure from overvoltage spikes on the supplies.

The low current error of these amplifiers make possible many designs that were previously impractical with monolithic amplifiers. They will operate from 100 M Ω source resistances, introducing less error than general purpose amplifiers with 10 k Ω sources. Integrators with worst case drifts less than 10 $\mu V/sec$ and analog time delays in excess of one day can also be made using capacitors no larger than 1 μF .

The LM216A and LM316A are high performance versions of the LM216 and LM316. The LM216 and LM216A are specified for operation from $-25^{\circ}C$ to $85^{\circ}C$, while the LM316 and LM316A are specified from $0^{\circ}C$ to $55^{\circ}C$.

Schematic Diagram **

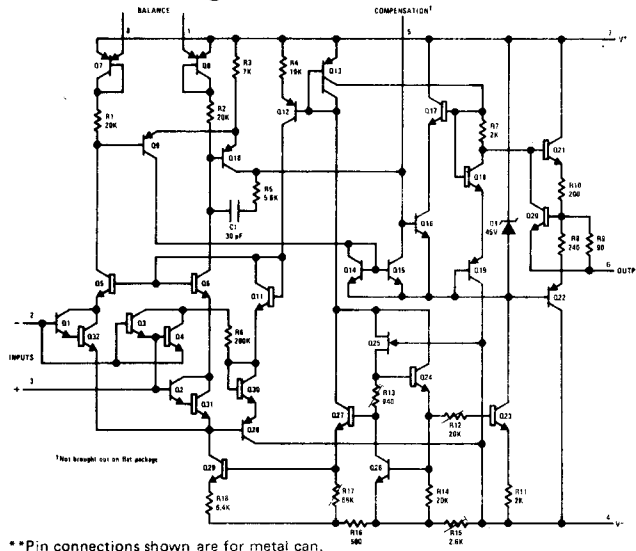

**Pin connections shown are for metal can.

Auxiliary Circuits **

Overcompensation for Greater Stability Margin

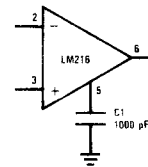

Offset Balancing

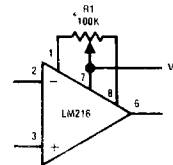

Connection Diagrams

Metal Can Package

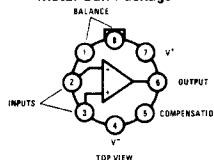

Order Number LM216H or LM216AH or LM316H or LM316AH
See NS Package H08C

Absolute Maximum Ratings

Supply Voltage	±20V
Power Dissipation (Note 1)	500 mW
Differential Input Current (Note 2)	±10 mA
Input Voltage (Note 3)	±15V
Output Short-Circuit Duration	Indefinite
Operating Temperature Range	LM216/LM216A -25°C to 85°C LM316/LM316A 0°C to 70°C
Storage Temperature Range	-65°C to 150°C
Lead Temperature (Soldering, 10 sec)	300°C

Electrical Characteristics (Note 4)

PARAMETER	CONDITIONS	LM216A	LM216	LM316A	LM316	UNITS
Input Offset Voltage	$T_A = 25^\circ\text{C}$, Max	3	10	3	10	mV
Input Offset Current	$T_A = 25^\circ\text{C}$, Max	15	50	15	50	pA
Input Bias Current	$T_A = 25^\circ\text{C}$, Max	50	150	50	150	pA
Input Resistance	$T_A = 25^\circ\text{C}$, Min	5	1	5	1	GΩ
Supply Current	$T_A = 25^\circ\text{C}$, Max	0.6	0.8	0.6	0.8	mA
Large Signal Voltage Gain	$T_A = 25^\circ\text{C}$, $V_S = \pm 15\text{V}$, $V_{OUT} = \pm 10\text{V}$, $R_L \geq 10\text{ k}\Omega$, Min	40	20	40	20	V/mV
Input Offset Voltage	Max	6	15	6	15	mV
Input Offset Current	Max	30	100	30	100	pA
Input Bias Current	Max	100	250	100	250	pA
Supply Current	$T_A = T_{MAX}$, Max	0.5		0.5		mA
Large Signal Voltage Gain	$V_S = \pm 15\text{V}$, $V_{OUT} = \pm 10\text{V}$, $R_L > 10\text{ k}\Omega$, Min	20	10	30	15	V/mV
Output Voltage Swing	$V_S = \pm 15\text{V}$, $R_L = 10\text{ k}\Omega$, Min	±13	±13	±13	±13	V
Input Voltage Range	$V_S = \pm 15\text{V}$, Min	±13	±13	±13	±13	V
Common-Mode Rejection Ratio	Min	80	80	80	80	dB
Supply Voltage Rejection Ratio	Min	80	80	80	80	dB

Note 1: The maximum junction temperature of the LM216 and LM216A is 100°C, while that of the LM316 and LM316A is 70°C. For operating at elevated temperatures, devices in the TO-5 package must be derated based on a thermal resistance of 150°C/W, junction to ambient, or 45°C/W, junction to case.

Note 2: The inputs are shunted with back-to-back diodes for overvoltage protection. Therefore, excessive current will flow if a differential input voltage in excess of 1V is applied between the inputs unless some limiting resistance is used.

Note 3: For supply voltages less than ±15V, the absolute maximum input voltage is equal to the supply voltage.

Note 4: These specifications apply for $\pm 5\text{V} < V_S < \pm 20\text{V}$ and $-25^\circ\text{C} < T_A < 85^\circ\text{C}$, unless otherwise specified. With the LM316 and LM316A however, all temperature specifications are limited to $0^\circ\text{C} < T_A < 55^\circ\text{C}$.

Typical Performance Characteristics

Input Currents

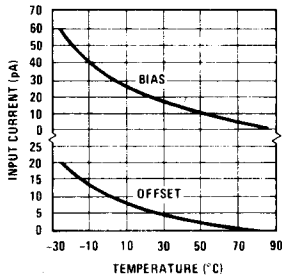

Offset Error

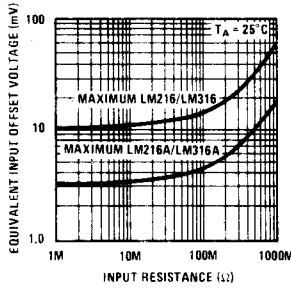

Input Current

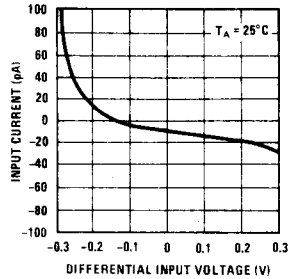

Input Noise Voltage

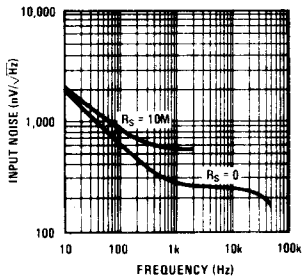

Power Supply Rejection

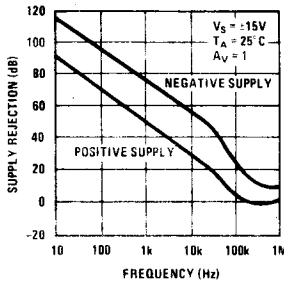

Closed Loop Output Impedance

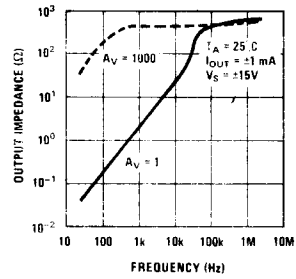

Voltage Gain

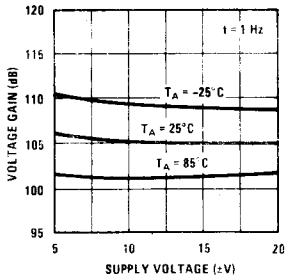

Output Swing

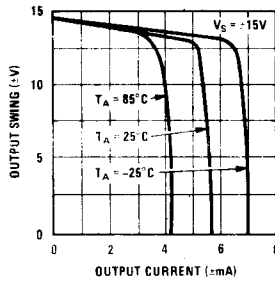

Supply Current

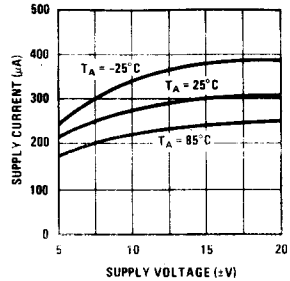

Open Loop Frequency Response

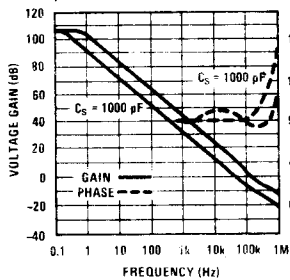

Large Signal Frequency Response

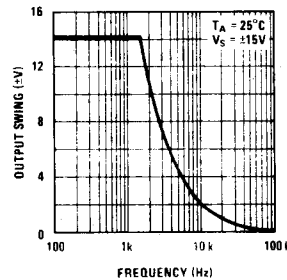

Voltage Follower Pulse Response

