



## LM318

## LINEAR INTEGRATED CIRCUIT

### HIGH SPEED OPERATIONAL AMPLIFIER

#### DESCRIPTION

The UTC **LM318** is a precision, high speed, high gain operational amplifier that has been specifically designed for use in high slew rate and wide bandwidth applications. Unlike many wideband amplifiers, the UTC **LM318** is unity-gain stable since it has internal circuitry for frequency compensation. However, external components may be added for compensation to achieve optimum performance.

When used in inverting applications, feed-forward compensation can be used to achieve slew rate in excess of 150V/μs and almost double the bandwidth. For greater stability, using overcompensation with the amplifier is possible if maximum bandwidth is not needed. In general, by adding a single capacitor can reduce the settling time for 0.1% error band to under 1μs.

The typical applications of UTC **LM318** include A/D converters, fast integrator, oscillators, active filters, sample and hold circuits, or general purpose amplifiers.

#### FEATURES

- \* Unit gain stable (internal frequency compensation)
- \* 4mV typical input offset voltage
- \* 30nA typical input offset current
- \* Input bias current of 250nA (maximum)
- \* 15MHz bandwidth (small signal)
- \* 50V/μs slew rate (guarantee)
- \* Operates voltages of ±5V to ±20V
- \* Overload protection for Input and output
- \* Same pin assignment as general-purpose op amps

#### ORDERING INFORMATION

Order Number		Package	Packing
Lead Free	Halogen Free		
LM318L-D08-T	LM318G-D08-T	DIP-8	Tube
LM318L-S08-R	LM318G-S08-R	SOP-8	Tape Reel

<p>LM318L-D08-T</p> <p>(1) Packing Type (2) Package Type (3) Green Package</p>	<p>(1) T: Tube, R: Tape Reel (2) D08: DIP-8, S08: SOP-8 (3) L: Lead Free, G: Halogen Free and Lead Free</p>
----------------------------------------------------------------------------------------	---------------------------------------------------------------------------------------------------------------------

#### MARKING

DIP-8	SOP-8
<p>UTC LM318</p> <p>Date Code L: Lead Free G: Halogen Free Lot Code</p>	<p>UTC LM318</p> <p>Date Code L: Lead Free G: Halogen Free Lot Code</p>

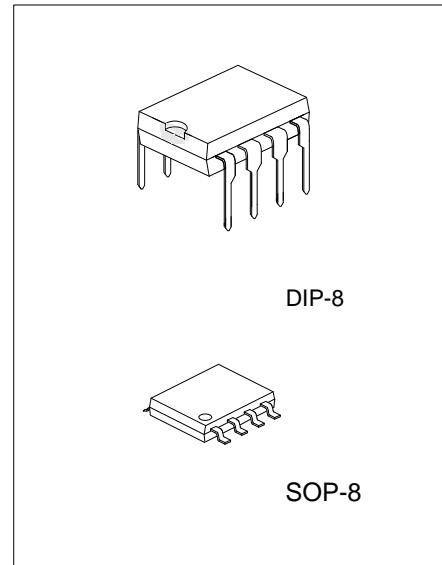

## ■ PIN CONFIGURATIONS

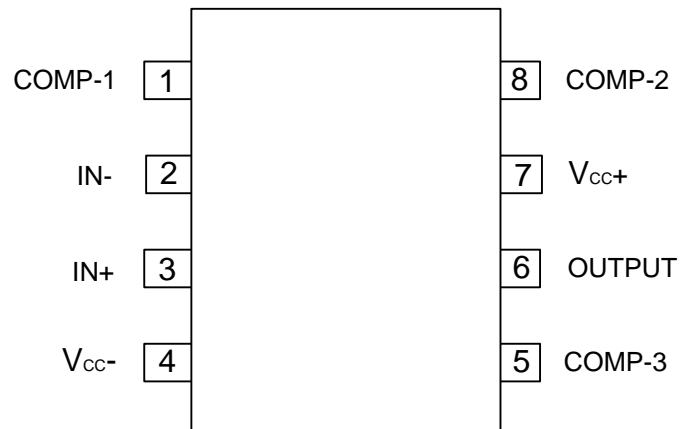

## ■ SCHEMATIC DIAGRAM

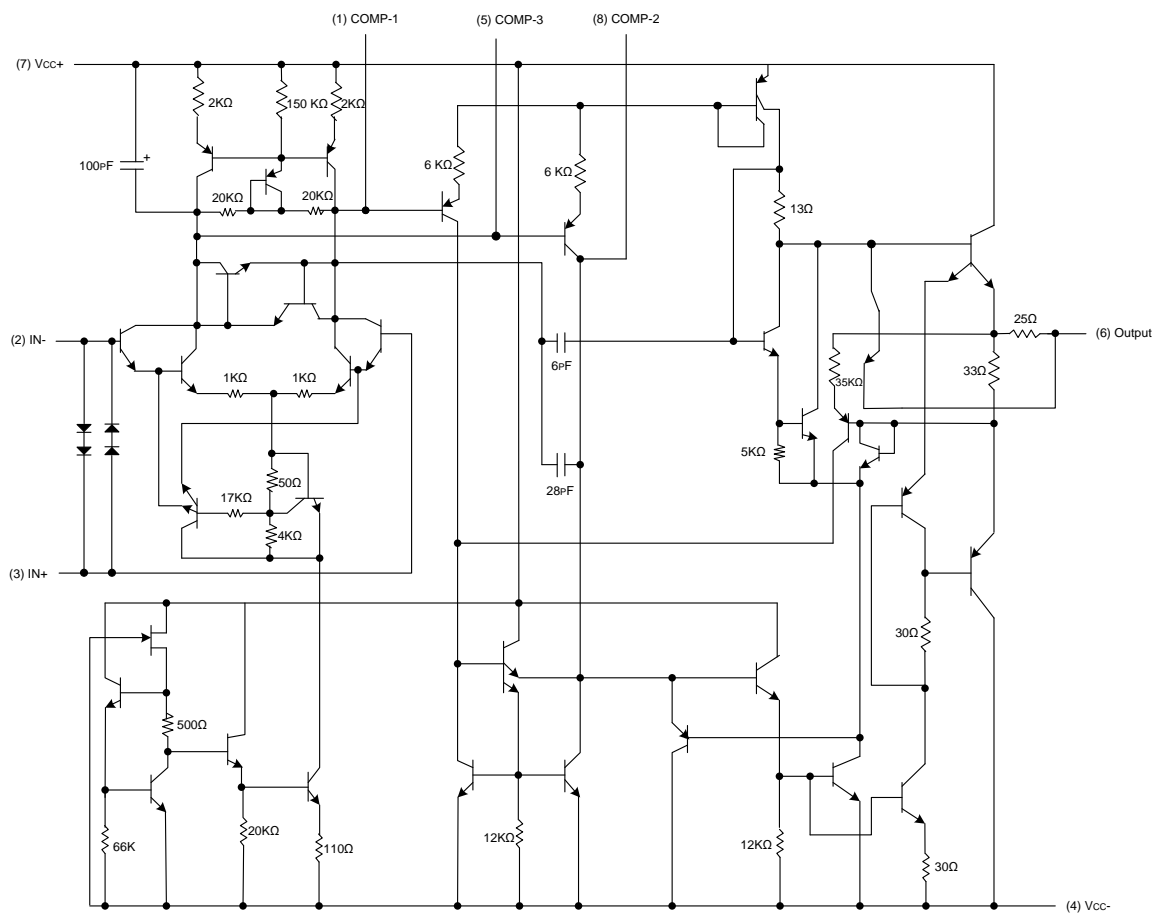

### ■ ABSOLUTE MAXIMUM RATINGS

PARAMETER	SYMBOL	RATINGS	UNIT
Supply Voltage	$V_{CC+}$	+20	V
Supply Voltage	$V_{CC-}$	-20	V
Input Voltage (Note 2)	$V_{IN}$	$\pm 15$	V
Differential Input Current (Note 3)	$I_{I(DIFF)}$	$\pm 10$	mA
Power Dissipation	$P_D$	500	mW
Output Short-Circuit Duration		Continuous	
Maximum Junction Temperature	$T_J$	110	$^{\circ}\text{C}$
Operating Temperature Range	$T_{OPR}$	0 ~ +70	$^{\circ}\text{C}$
Storage Temperature Range	$T_{STG}$	-65 ~ +150	$^{\circ}\text{C}$

- Notes: 1. Absolute maximum ratings are those values beyond which the device could be permanently damaged. Absolute maximum ratings are stress ratings only and functional device operation is not implied.
2. For supply voltage less than  $\pm 15\text{V}$ , the absolute maximum input voltage is equal to the supply voltage.
3. The inputs are shunted with two opposite-facing base-emitter diodes for over voltage protection. Therefore, excessive current flows if a differential input voltage in excess of 1V is applied between the inputs unless some limiting resistance is used.

### ■ ELECTRICAL CHARACTERISTICS ( $\pm 5\text{V} \leq V_{CC} \leq \pm 20\text{V}$ , $0^{\circ}\text{C} \leq T_A \leq +70^{\circ}\text{C}$ , unless other specifics)

PARAMETER	SYMBOL	TEST CONDITION	MIN	TYP	MAX	UNIT
Input Voltage Range	$V_{IN}$	$V_{CC} = \pm 15\text{V}$	$\pm 11.5$			V
Output Voltage Swing	$V_{OUT}$	$V_{CC} = \pm 15\text{V}$ , $R_L = 2\text{K}\Omega$	$\pm 12$	$\pm 13$		V
Input Offset Voltage	$V_{I(OFF)}$	$T_A = 25^{\circ}\text{C}$		4	10	mV
					15	mV
Large Signal Voltage Gain	$G_V$	$T_A = 25^{\circ}\text{C}$ , $V_{CC} = \pm 15\text{V}$ $V_{OUT} = \pm 10\text{V}$ , $R_L \geq 2\text{K}\Omega$	25	200		V/mV
		$V_{CC} = \pm 15\text{V}$ , $V_{OUT} = \pm 10\text{V}$ , $R_L \geq 2\text{K}\Omega$	20			V/mV
Input Offset Current	$I_{I(OFF)}$	$T_A = 25^{\circ}\text{C}$		30	200	nA
					300	nA
Input Bias Current	$I_{I(BIAS)}$	$T_A = 25^{\circ}\text{C}$		150	500	nA
					750	nA
Supply Current	$I_{SS}$	$T_A = 25^{\circ}\text{C}$		5	10	mA
Input Resistance	$R_S$	$T_A = 25^{\circ}\text{C}$	0.5	3		$\text{M}\Omega$
Slew Rate	SR	$T_A = 25^{\circ}\text{C}$ , $V_{CC} = \pm 15\text{V}$ , $G_V = 1$	50	70		$\text{V}/\mu\text{s}$
Small Signal Bandwidth	$SB_W$	$T_A = 25^{\circ}\text{C}$ , $V_{CC} = \pm 15\text{V}$		15		MHz
Common Mode Rejection Ratio	CMRR		70	100		dB
Supply Voltage Rejection Ratio	SVRR		65	80		dB

Note: These power supplies must be bypassed with 0.1 $\mu\text{F}$  (or larger) disc ceramic capacitor within an inch of the device.

## ■ TYPICAL CHARACTERISTICS

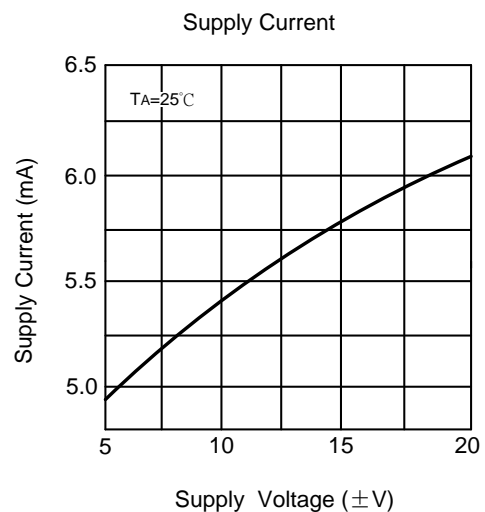
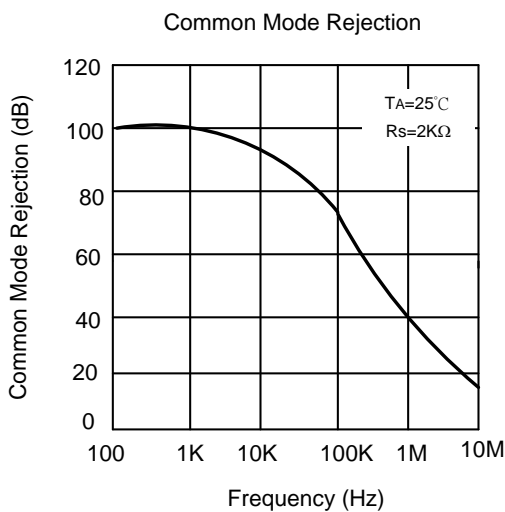
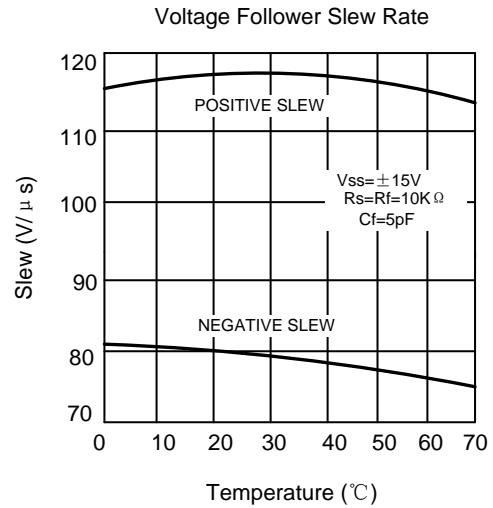
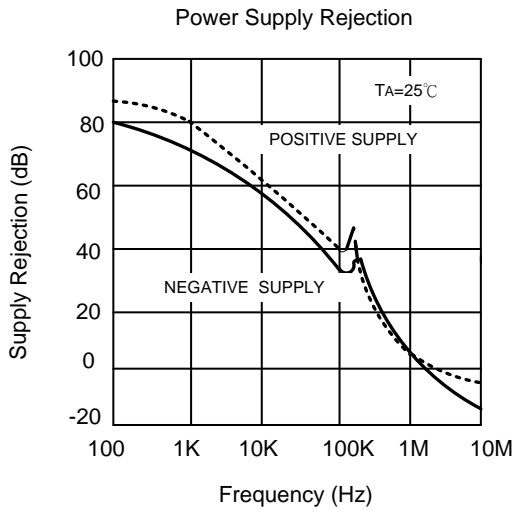
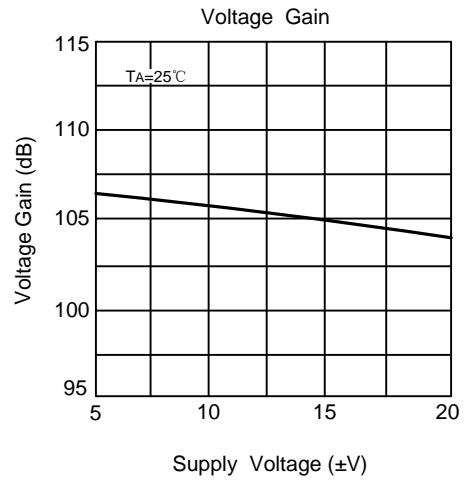
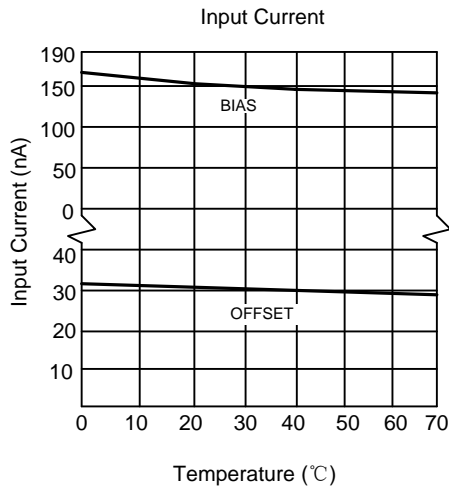

### ■ TYPICAL CHARACTERISTICS (Cont.)

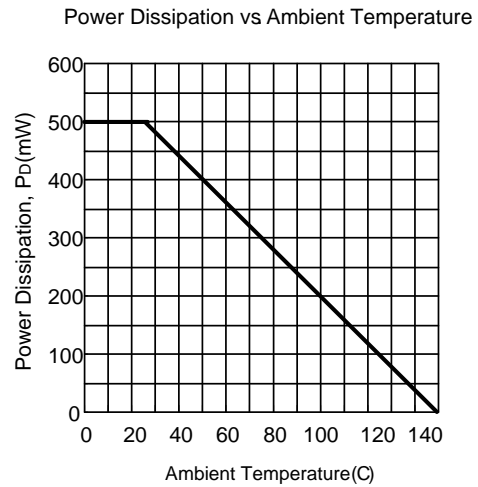
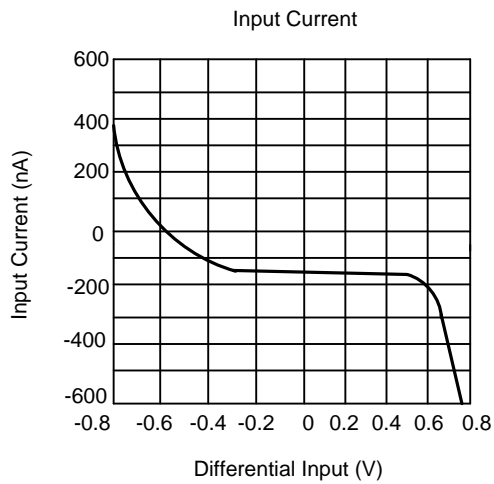

UTC assumes no responsibility for equipment failures that result from using products at values that exceed, even momentarily, rated values (such as maximum ratings, operating condition ranges, or other parameters) listed in products specifications of any and all UTC products described or contained herein. UTC products are not designed for use in life support appliances, devices or systems where malfunction of these products can be reasonably expected to result in personal injury. Reproduction in whole or in part is prohibited without the prior written consent of the copyright owner. UTC reserves the right to make changes to information published in this document, including without limitation specifications and product descriptions, at any time and without notice. This document supersedes and replaces all information supplied prior to the publication hereof.