

LM342 Series 3-Terminal Positive Regulators

General Description

The LM342-XX series of three-terminal regulators is available with several fixed output voltages, making them useful in a wide range of applications. One of these is local on card regulation, eliminating the distribution problems associated with single point regulation. The voltages available allow these regulators to be used in logic systems, instrumentation, HiFi, and other solid state electronic equipment. Although designed primarily as fixed voltage regulators these devices can be used with external components to obtain adjustable voltages and currents.

The LM342-XX series is available in the plastic TO-202 package. This package allows these regulators to deliver over 0.25A if adequate heat sinking is provided. Current limiting is included to limit the peak output current to a safe value. Safe area protection for the output transistor is provided to limit internal power dissipation. If internal power dissipation becomes too high for the heat sinking provided, the thermal shutdown circuit takes over, preventing the IC from overheating.

Considerable effort was expended to make the LM342-XX series of regulators easy to use and minimize the number of external components. It is not necessary to bypass the

output, although this does improve transient response. Input bypassing is needed only if the regulator is located far from the filter capacitor of the power supply.

For output voltage other than 5V, 12V and 15V the LM117 series provides an output voltage range from 1.2V to 57V.

Features

- Output current in excess of 0.25A
- Internal thermal overload protection
- No external components required
- Output transistor safe area protection
- Internal short circuit current limit
- Available in plastic TO-202 package
- Special circuitry allows start-up even if output is pulled to negative voltage (\pm supplies)

Voltage Range

| | |
|-----------|-----|
| LM342-5.0 | 5V |
| LM342-12 | 12V |
| LM342-15 | 15V |

Schematic Diagram

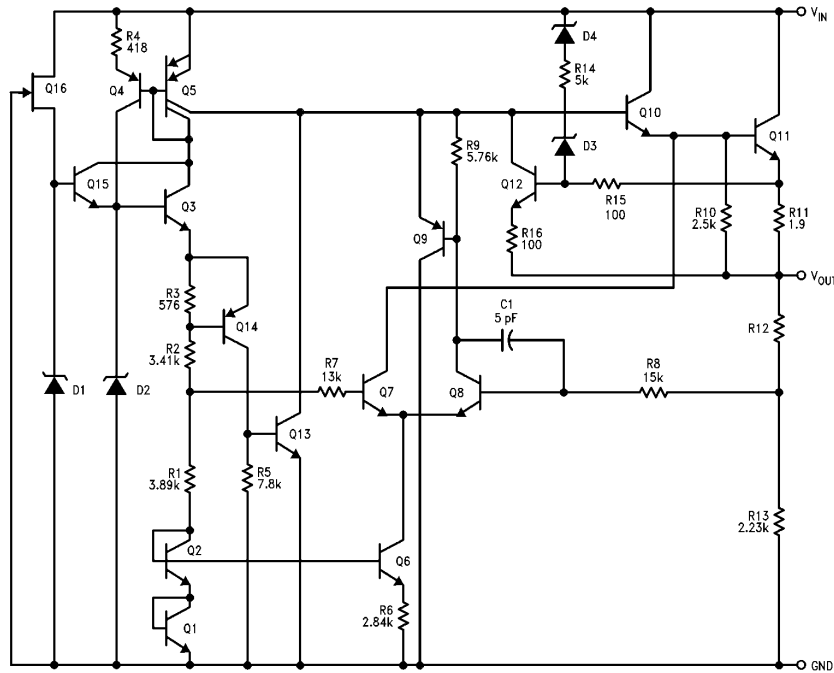

TL/H/10485-1

Absolute Maximum Ratings (Note 1)

If Military/Aerospace specified devices are required, please contact the National Semiconductor Sales Office/Distributors for availability and specifications.

Input Voltage

$V_O = 5V$ 30V

$V_O = 12V$ and $15V$ 35V

Internal Power Dissipation Internally Limited

Operating Temperature Range $0^{\circ}C$ to $+70^{\circ}C$

Maximum Junction Temperature $125^{\circ}C$

Storage Temperature Range $-65^{\circ}C$ to $+150^{\circ}C$

Lead Temperature (Soldering, 10 sec.) $300^{\circ}C$

ESD Susceptibility TBD

Electrical Characteristics $T_A = 0^{\circ}C$ to $+70^{\circ}C$, $I_O = 250$ mA (Note 2) unless noted

| Output Voltage | | | 5V | | | 12V | | | 15V | | | Units |
|--|--|--|------|-----|-------------------------------|------|-----|--------------------------------|-------|-----|--------------------------------|---------------|
| Input Voltage (unless otherwise noted) | | | 10V | | | 19V | | | 23V | | | |
| Symbol | Parameter | Conditions | Min | Typ | Max | Min | Typ | Min | Min | Typ | Max | |
| V_O | Output Voltage (Note 3) | $T_J = 25^{\circ}C$ | 4.8 | 5 | 5.2 | 11.5 | 12 | 12.5 | 14.4 | 15 | 15.6 | V |
| | | $1\text{ mA} \leq I_O \leq 250\text{ mA}$ and $V_{MIN} \leq V_{IN} \leq V_{MAX}$ | 4.75 | | 5.25 | 11.4 | | 12.6 | 14.25 | | 15.75 | V |
| ΔV_O | Line Regulation | $T_J = 25^{\circ}C$, $I_O = 250\text{ mA}$ | | | 55 | | | 100 | | | 100 | mV |
| | | | | | ($7.3 \leq V_{IN} \leq 25$) | | | ($14.6 \leq V_{IN} \leq 30$) | | | ($17.7 \leq V_{IN} \leq 30$) | |
| ΔV_O | Load Regulation | $T_J = 25^{\circ}C$, $1\text{ mA} \leq I_O \leq 250\text{ mA}$ | | | 50 | | | 120 | | | 150 | mV |
| ΔV_O | Long Term Stability | | | | 20 | | | 48 | | | 60 | mV/khrs |
| I_Q | Quiescent Current | $T_J = 25^{\circ}C$ | | | 6 | | | 6 | | | 6 | mA |
| ΔI_Q | Quiescent Current Change | $T_J = 25^{\circ}C$, $1\text{ mA} \leq I_O \leq 250\text{ mA}$ | | | 0.5 | | | 0.5 | | | 0.5 | mA |
| | | $T_J = 25^{\circ}C$, $V_{MIN} \leq V_{IN} \leq V_{MAX}$ | | | 1.5 | | | 1.5 | | | 1.5 | mA |
| | | | | | ($7.3 \leq V_{IN} \leq 25$) | | | ($14.6 \leq V_{IN} \leq 30$) | | | ($17.7 \leq V_{IN} \leq 30$) | |
| V_n | Output Noise Voltage | $T_J = 25^{\circ}C$, $f = 10\text{ Hz} - 10\text{ kHz}$ | | | 40 | | | 96 | | | 120 | μV |
| $\frac{\Delta V_{IN}}{\Delta V_{OUT}}$ | Ripple Rejection | $f = 120\text{ Hz}$ | 50 | 64 | | 44 | 56 | | 42 | 56 | | dB |
| | Input Voltage Required to Maintain Line Regulation | $T_J = 25^{\circ}C$, $I_O = 250\text{ mA}$ | | | 7.3 | | | 14.6 | | | 17.7 | V |
| | Thermal Resistance Junction to Case | P Package | | | 15 | | | 15 | | | 15 | $^{\circ}C/W$ |
| | Thermal Resistance Junction to Ambient | P Package | | | 80 | | | 80 | | | 80 | $^{\circ}C/W$ |

Note 1: Absolute Maximum Ratings indicate limits beyond which damage to the device may occur. Operating Ratings indicate conditions for which the device is intended to be functional, but do not guarantee specific performance limits. For guaranteed specifications and test conditions, see the Electrical Characteristics.

Note 2: The electrical characteristics data represent pulse test conditions with junction temperatures as shown at the initiation of tests.

Note 3: The temperature coefficient of V_{OUT} is typically within 0.01% $V_O/^{\circ}C$.

Typical Performance Characteristics

Maximum Average Power Dissipation (TO-202 Package)

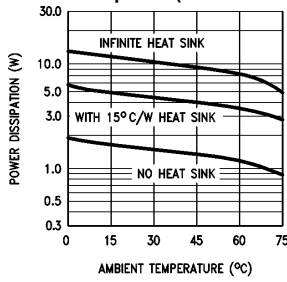

Peak Output Current

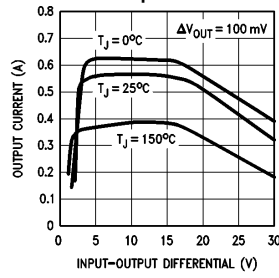

Dropout Voltage

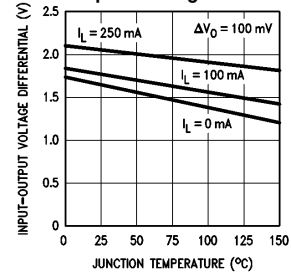

Ripple Rejection

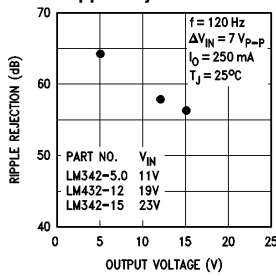

Ripple Rejection

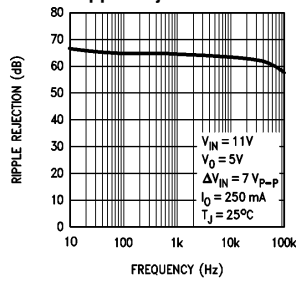

Output Impedance

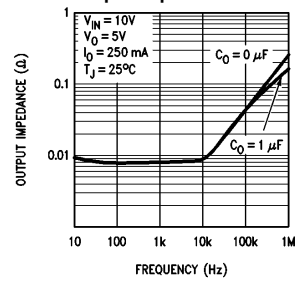

Quiescent Current

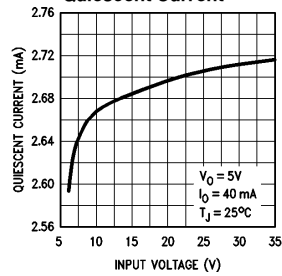

Quiescent Current

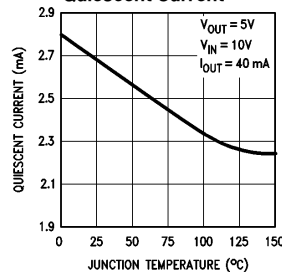

TL/H/10485-3

Connection Diagram

TO-202 (P) Plastic Package

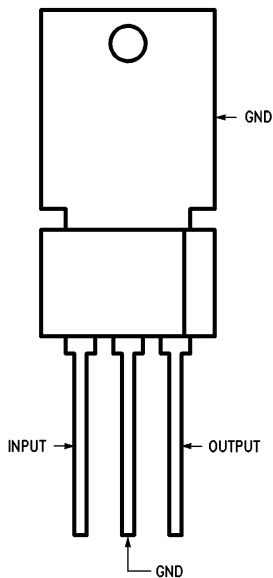

TL/H/10485-2

Order Number LM342P-5.0,
LM342P-12 or LM342P-15
See NS Package Number P03A

Typical Applications

Fixed Output Regulator

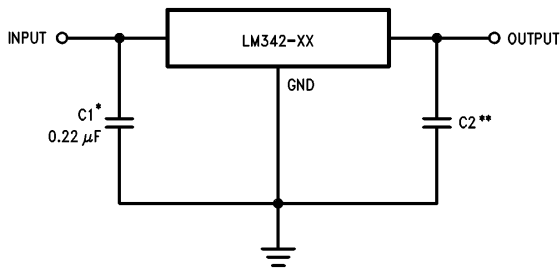

TL/H/10485-4

*Required if the regulator is located far from power supply filter

**Although not required, C2 does improve transient response. (If needed, use 0.1 μF ceramic disc.)

Adjustable Output Regulator

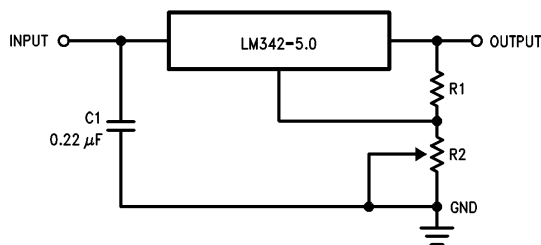

TL/H/10485-5

$$V_O = 5V + (5V/R1 + I_Q) R2$$

$$5V/R1 > 3I_Q, \text{ Load Regulation (L}_R\text{)} = [(R1 + R2)/R1] \times (L_r \text{ of LM342-05})$$

Current Regulator

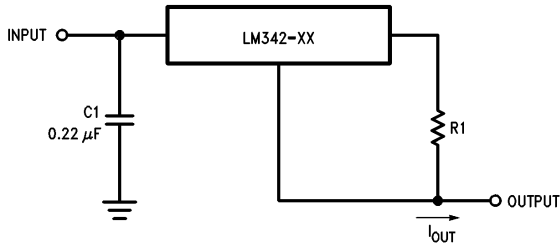

TL/H/10485-6

$$I_{OUT} = V^2 - 3/R1 + I_Q$$

$$\Delta I_Q \leq 1.5 \text{ mA over line and load changes}$$

Typical Applications (Continued)

High Output Voltage Regulator

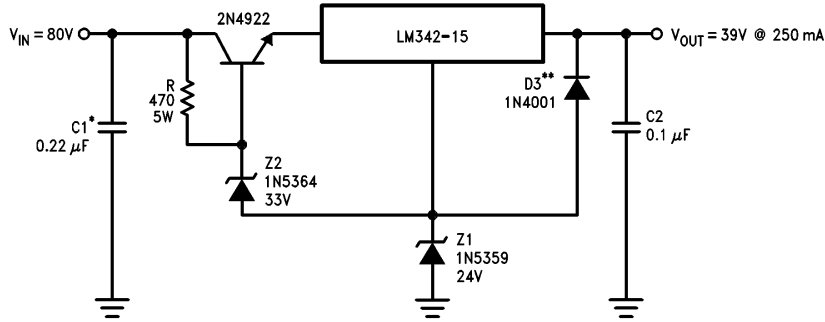

TL/H/10485-7

*Necessary if regulator is located far from the power supply filter

**D3 aids in full load start-up and protects the regulator during short circuits from high input to output voltage differentials

± 15V, 250 mA Dual Power Supply

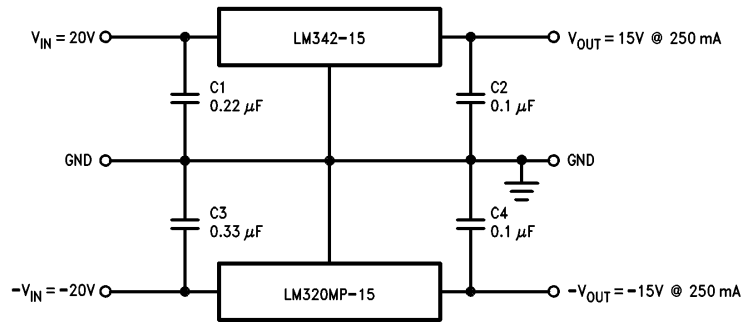

TL/H/10485-8

Variable Output Regulator 0.5V – 18V

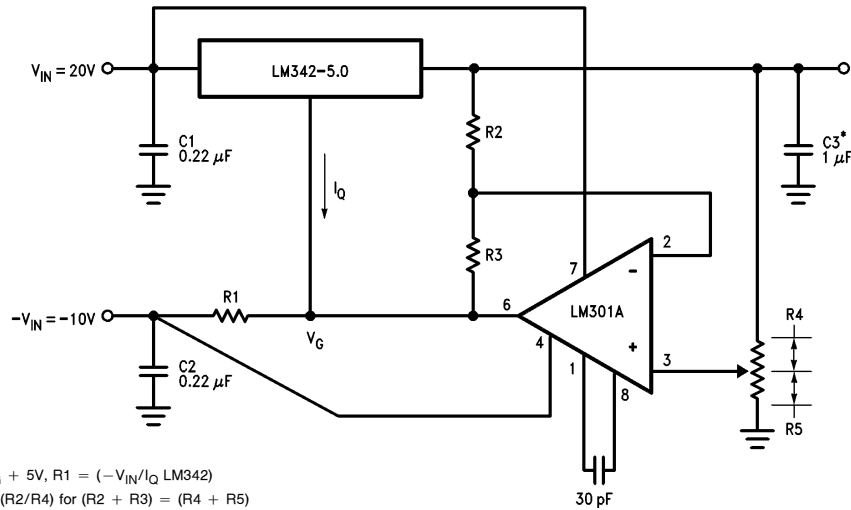

$$V_{OUT} = V_G + 5V, R_1 = (-V_{IN}/I_Q \text{ LM342})$$

$$V_{OUT} = 5V(R_2/R_4) \text{ for } (R_2 + R_3) = (R_4 + R_5)$$

$$\text{A } 0.5V \text{ output will correspond to } (R_2/R_4) = 0.1, (R_3/R_4) = 0.9$$

*Solid tantalum

TL/H/10485-9

