

LM34922 28V, 2A Constant On-Time Switching Regulator with Adjustable Current Limit

Check for Samples: [LM34922](#)

FEATURES

- Input Operating Voltage Range: 6V to 28V
- Absolute Maximum Input Rating: 30V
- Integrated 2A N-Channel Buck Switch
- Adjustable Current Limit Allows for Smaller Inductor
- Adjustable Output Voltage from 2.51V
- Minimum Ripple Voltage at V_{OUT}
- Power Good Output
- Switching Frequency Adjustable to 1MHz
- COT Topology Features:
 - Switching Frequency Remains Nearly Constant with Load Current and Input Voltage Variations
 - Ultra-Fast Transient Response
 - No Loop Compensation Required
 - Stable Operation with Ceramic Output Capacitors
 - Allows for Smaller Output Capacitor and Current Sense Resistor
- Adjustable Soft-Start Timing

- Thermal Shutdown
- Precision 2% Feedback Reference

DESCRIPTION

The LM34922 Constant On-time Step-Down Switching Regulator features all the functions needed to implement a low cost, efficient, buck bias regulator capable of supplying up to 2A of load current. This voltage regulator contains an N-Channel Buck switch, a startup regulator, current limit detection, and internal ripple control. The constant on-time regulation principle requires no loop compensation, results in fast load transient response, and simplifies circuit implementation. The operating frequency remains constant with line and load. The adjustable valley current limit detection results in a smooth transition from constant voltage to constant current mode when current limit is reached, without the use of current limit foldback. The PGD output indicates the output voltage has increased to within 5% of the expected regulation value. Additional features include: Low output ripple, VIN under-voltage lock-out, adjustable soft-start timing, thermal shutdown, gate drive pre-charge, gate drive under-voltage lock-out, and maximum duty cycle limit.

Typical Application, Basic Step-Down Regulator

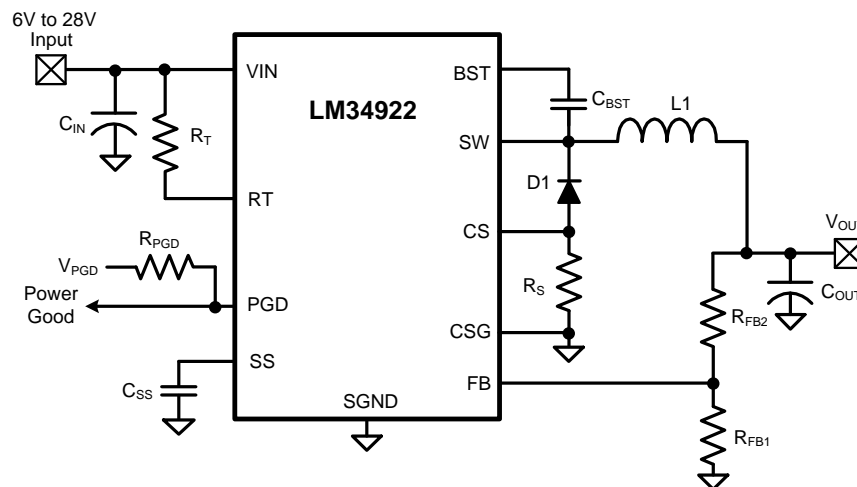

Please be aware that an important notice concerning availability, standard warranty, and use in critical applications of Texas Instruments semiconductor products and disclaimers thereto appears at the end of this data sheet.

All trademarks are the property of their respective owners.

Connection Diagram

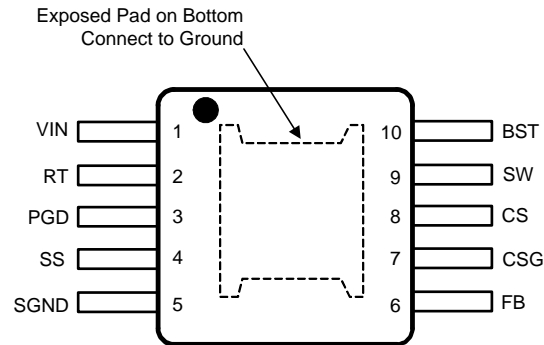

**Figure 1. Top View
10-Lead HVSSOP-PowerPAD**

PIN DESCRIPTIONS

Pin No.	Name	Description	Application Information
1	VIN	Input supply voltage	Operating input range is 6V to 28V. Transient capability is 30V. A low ESR capacitor must be placed as close as possible to the VIN and SGND pins.
2	RT	On-time Control	An external resistor from VIN to this pin sets the buck switch on-time, and the switching frequency.
3	PGD	Power Good	Logic output indicates when the voltage at the FB pin has increased to above 95% of the internal reference voltage. Hysteresis is provided. An external pull-up resistor to a voltage less than 7V is required.
4	SS	Soft-Start	An internal current source charges an external capacitor to provide the soft-start function.
5	SGND	Signal Ground	Ground for all internal circuitry other than the current limit sense circuit.
6	FB	Feedback	Internally connected to the regulation comparator. The regulation level is 2.51V.
7	CSG	Current Sense Ground	Ground connection for the current limit sensing circuit. Connect to ground and to the current sense resistor.
8	CS	Current sense	Connect to the current sense resistor and the anode of the free-wheeling diode.
9	SW	Switching Node	Internally connected to the buck switch source. Connect to the external inductor, cathode of the free-wheeling diode, and bootstrap capacitor.
10	BST	Bootstrap capacitor connection of the buck switch gate driver.	Connect a 0.1 μ F capacitor from SW to this pin. The capacitor is charged during the buck switch off-time via an internal diode.



These devices have limited built-in ESD protection. The leads should be shorted together or the device placed in conductive foam during storage or handling to prevent electrostatic damage to the MOS gates.

Absolute Maximum Ratings ⁽¹⁾⁽²⁾⁽³⁾

VIN to SGND (T _J = 25°C)		30V
BST to SGND		37V
SW to SGND (Steady State)		-1.5V to 30V
BST to SW		-0.3V to 7V
CS to CSG		-0.3V to 0.3V
CSG to SGND		-0.3V to 0.3V
PGD to SGND		-0.3V to 7V
SS to SGND		-0.3V to 3V
RT to SGND		-0.3V to 1V
FB to SGND		-0.3V to 7V
ESD Rating ⁽⁴⁾	Human Body Model	2kV
Storage Temperature Range		-65°C to +150°C
For soldering specs see: SNOA549C		
Junction Temperature		150°C

- (1) Absolute Maximum Ratings are limits beyond which damage to the device may occur. Operating Ratings are conditions under which operation of the device is intended to be functional. For specifications and test conditions, see the Electrical Characteristics.
- (2) If Military/Aerospace specified devices are required, please contact the Texas Instruments Sales Office/ Distributors for availability and specifications.
- (3) Current flow out of a pin is indicated as a negative number.
- (4) The human body model is a 100pF capacitor discharged through a 1.5kΩ resistor into each pin.

Operating Ratings ⁽¹⁾

VIN Voltage	6.0V to 28V
Junction Temperature	-40°C to +125°C

- (1) Absolute Maximum Ratings are limits beyond which damage to the device may occur. Operating Ratings are conditions under which operation of the device is intended to be functional. For specifications and test conditions, see the Electrical Characteristics.

Electrical Characteristics

Specifications with standard type are for T_J = 25°C only; limits in **boldface type** apply over the full Operating Junction Temperature (T_J) range. Minimum and Maximum limits are specified through test, design, or statistical correlation. Typical values represent the most likely parametric norm at T_J = 25°C, and are provided for reference purposes only. Unless otherwise stated the following conditions apply: V_{IN} = 12V, R_T = 50kΩ.

Symbol	Parameter	Conditions	Min	Typ	Max	Units
Input (VIN Pin)						
I _{IN}	Input operating current	Non-switching, FB = 3V		1200	1600	μA
UVLO _{VIN}	VIN under-voltage lock-out threshold	VIN Increasing	4.6	5.3	5.9	V
	VIN under-voltage lock-out threshold hysteresis			200		mV
Switch Characteristics						
R _{DS(ON)}	Buck Switch R _{DS(ON)}	I _{TEST} = 200mA		0.3	0.6	Ω
UVLO _{GD}	Gate Drive UVLO	BST-SW	2.4	3.4	4.4	V
	UVLO _{GD} Hysteresis			350		mV
	Pre-charge switch voltage	I _{TEST} = 10mA into SW pin		1.4		V
	Pre-charge switch on-time			120		ns
Soft-Start Pin						
V _{SS}	Pull-up voltage			2.51		V
I _{SS}	Internal current source			10		μA
V _{SS-SH}	Shutdown Threshold		70	140		mV
Current Limit						

Electrical Characteristics (continued)

Specifications with standard type are for $T_J = 25^\circ\text{C}$ only; limits in **boldface type** apply over the full Operating Junction Temperature (T_J) range. Minimum and Maximum limits are specified through test, design, or statistical correlation. Typical values represent the most likely parametric norm at $T_J = 25^\circ\text{C}$, and are provided for reference purposes only. Unless otherwise stated the following conditions apply: $V_{IN} = 12\text{V}$, $R_T = 50\text{k}\Omega$.

Symbol	Parameter	Conditions	Min	Typ	Max	Units
V_{ILIM}	Threshold voltage at CS		-146	-130	-115	mV
	CS bias current	FB = 3V		-120		μA
	CSG bias current	FB = 3V		-35		μA
On Timer, RT Pin						
$t_{ON} - 1$	On-time	$V_{IN} = 12\text{V}$, $R_T = 50\text{k}\Omega$	150	200	250	ns
$t_{ON} - 2$	On-time (current limit)	$V_{IN} = 12\text{V}$, $R_T = 50\text{k}\Omega$		100		ns
$t_{ON} - 3$	On-time	$V_{IN} = 12\text{V}$, $R_T = 301\text{k}\Omega$		1020		ns
$t_{ON} - 4$	On-time	$V_{IN} = 9\text{V}$, $R_T = 30.9\text{k}\Omega$	130	171	215	ns
$t_{ON} - 5$	On-time	$V_{IN} = 12\text{V}$, $R_T = 30.9\text{k}\Omega$	105	137	170	ns
$t_{ON} - 6$	On-time	$V_{IN} = 16\text{V}$, $R_T = 30.9\text{k}\Omega$	79	109	142	ns
Off Timer						
t_{OFF}	Minimum Off-time (LM34922)		90	150	208	ns
Regulation Comparator (FB Pin)						
V_{REF}	FB regulation threshold	SS pin = steady state	2.46	2.51	2.56	V
	FB bias current	FB = 3V		100		nA
Power Good (PGD pin)						
	Threshold at FB, with respect to V_{REF}	FB increasing	91	95		%
	Threshold hysteresis			3.3		%
PGD_{VOL}	Low state voltage	$I_{PGD} = 1\text{mA}$, FB = 0V		125	180	mV
PGD_{LKG}	Off state leakage	$V_{PGD} = 7\text{V}$, FB = 3V		0.1		μA
Thermal Shutdown						
T_{SD}	Thermal shutdown	Junction temperature increasing		155		$^\circ\text{C}$
	Thermal shutdown hysteresis			20		$^\circ\text{C}$
Thermal Resistance						
θ_{JA}	Junction to Ambient, 0 LFPM Air Flow ⁽¹⁾			48		$^\circ\text{C/W}$
θ_{JC}	Junction to Case, ⁽¹⁾			10		$^\circ\text{C/W}$

(1) JEDEC test board description can be found in JESD 51-5 and JESD 51-7.

Typical Performance Characteristics

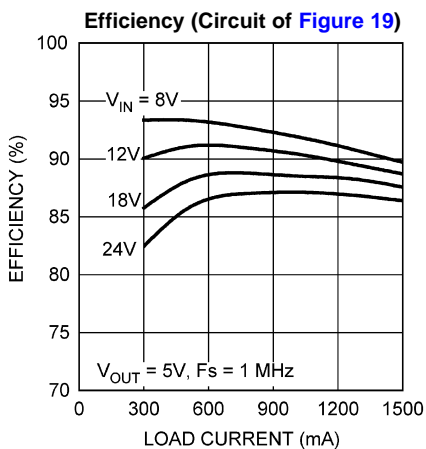

Figure 2.

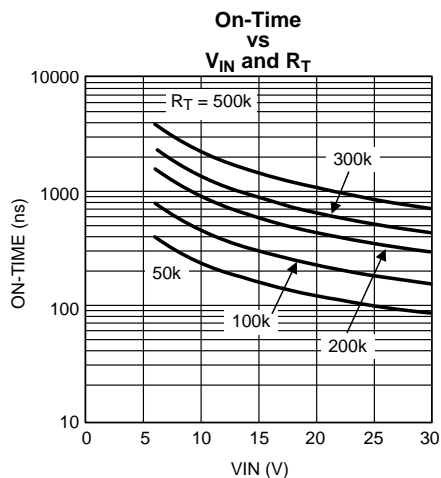

Figure 3.

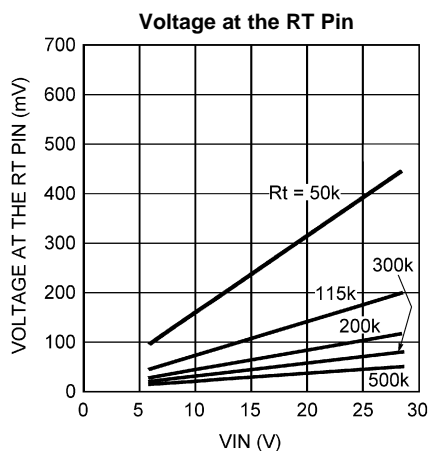

Figure 4.

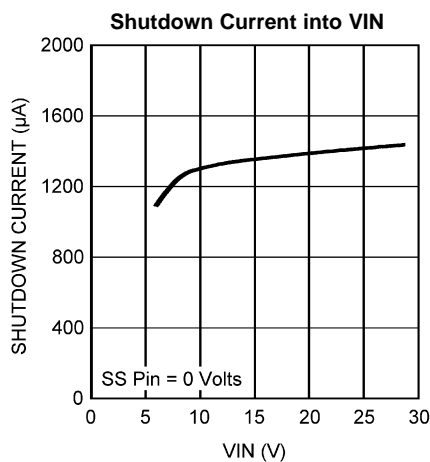

Figure 5.

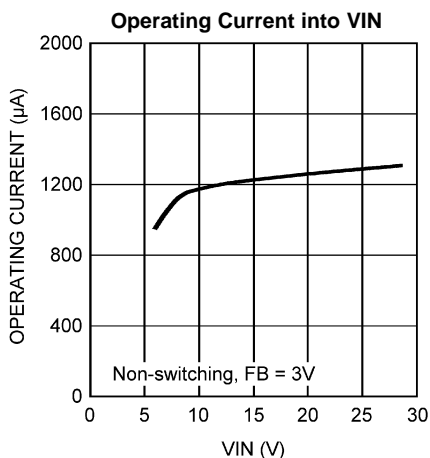

Figure 6.

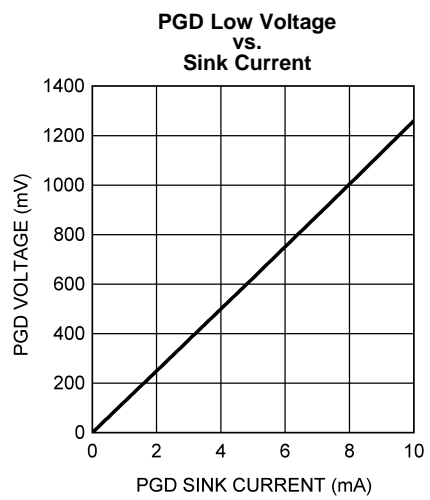

Figure 7.

Typical Performance Characteristics (continued)

Reference Voltage vs. Temperature

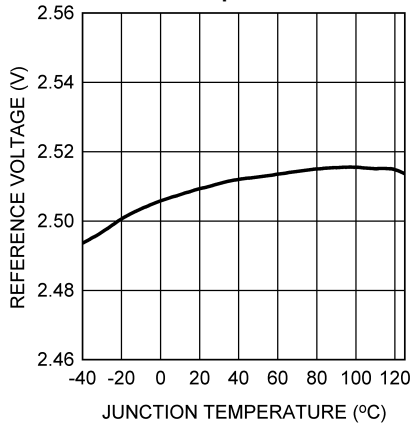

Figure 8.

Current Limit Threshold vs. Temperature

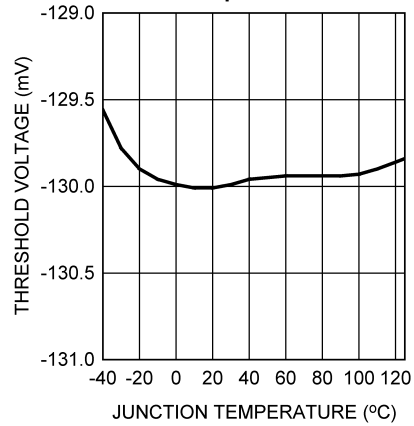

Figure 9.

Operating Current vs. Temperature

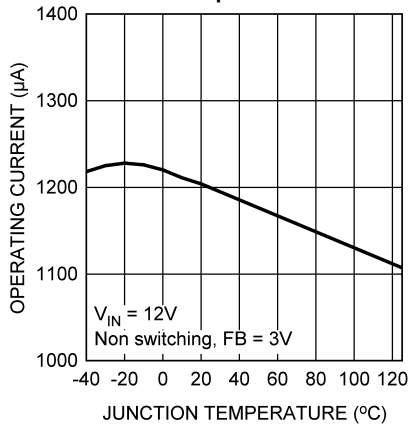

Figure 10.

VIN UVLO vs. Temperature

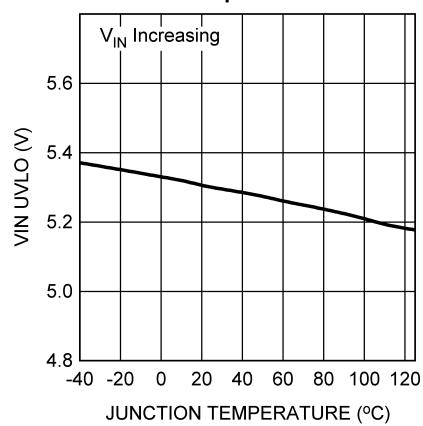

Figure 11.

SS Pin Shutdown Threshold vs. Temperature

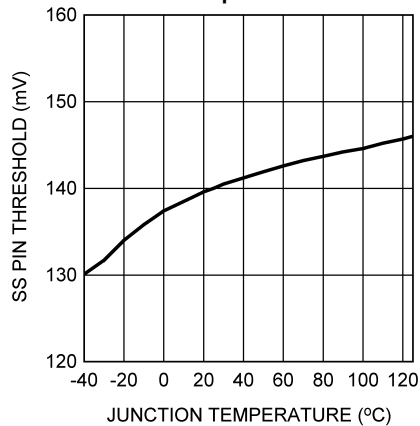

Figure 12.

On-Time vs. Temperature

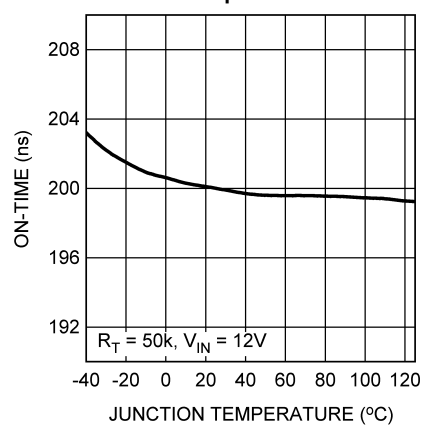

Figure 13.

Typical Performance Characteristics (continued)

Minimum Off-Time

vs.

Temperature (LM34922)

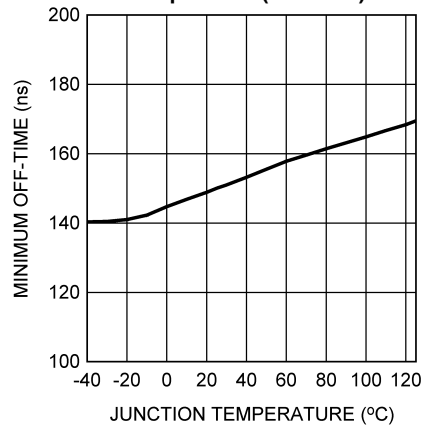

Figure 14.

Block Diagram

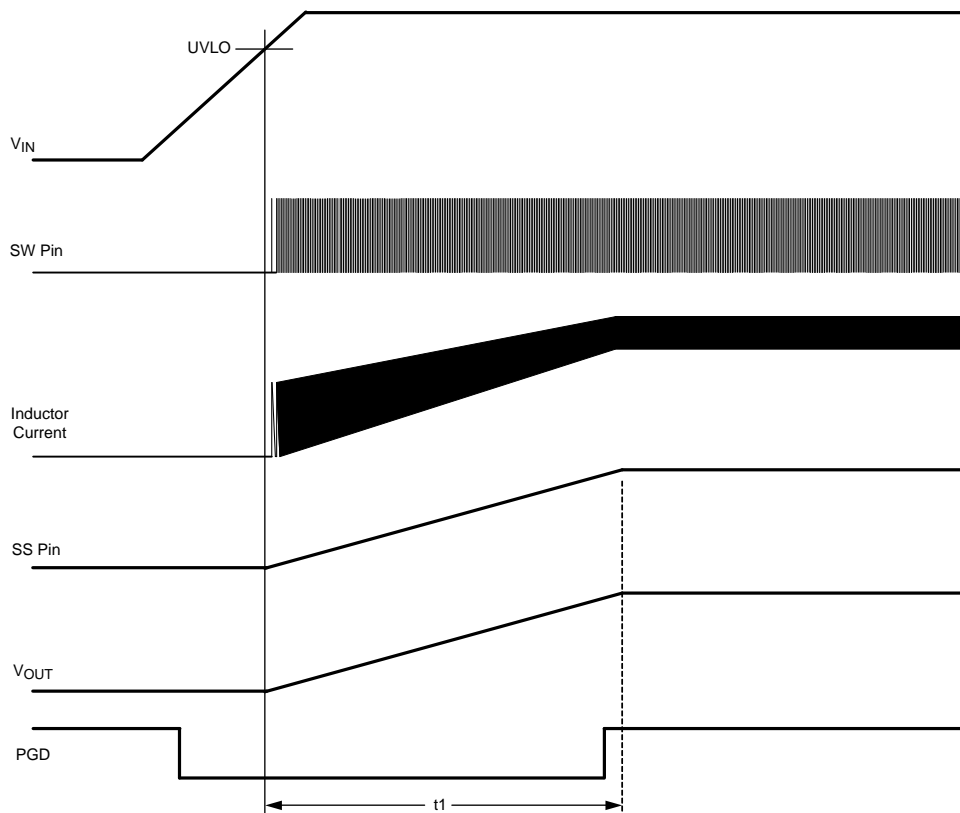
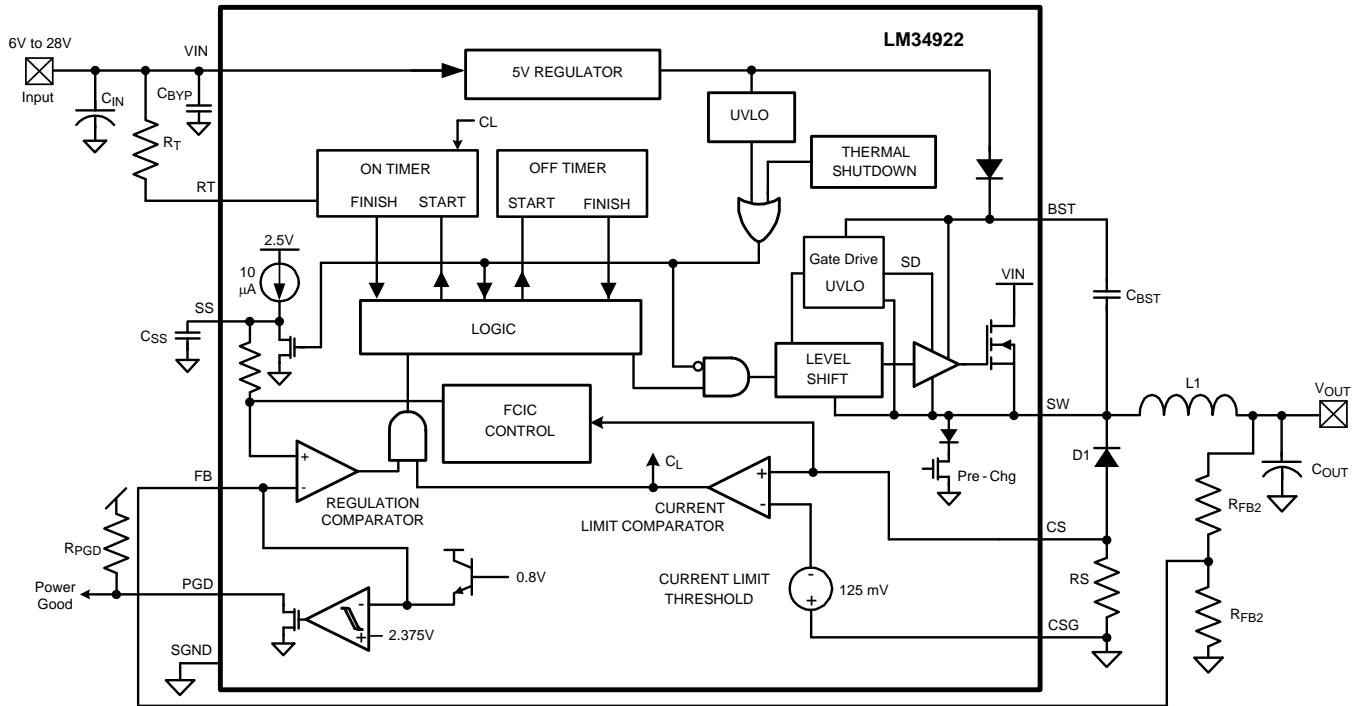

Figure 15. Startup Sequence

FUNCTIONAL DESCRIPTION

The LM34922 Constant On-time Step-down Switching Regulator features all the functions needed to implement a low cost, efficient buck bias power converter capable of supplying up to 2.0A to the load. This high voltage regulator contains an N-Channel buck switch, is easy to implement, and is available in a 10-pin HVSSOP-PowerPAD power enhanced package. The regulator's operation is based on a constant on-time control principle with the on-time inversely proportional to the input voltage. This feature results in the operating frequency remaining relatively constant with load and input voltage variations. The constant on-time feedback control principle requires no loop compensation resulting in very fast load transient response. The adjustable valley current limit detection results in a smooth transition from constant voltage to constant current when current limit is reached. To aid in controlling excessive switch current due to a possible saturating inductor the on-time is reduced by $\approx 40\%$ when current limit is detected. The Power Good output (PGD pin) indicates when the output voltage is within 5% of the expected regulation voltage.

The LM34922 can be implemented to efficiently step-down higher voltages in non-isolated applications. Additional features include: Low output ripple, VIN under-voltage lock-out, adjustable soft-start timing, thermal shutdown, gate drive pre-charge, gate drive under-voltage lock-out, and maximum duty cycle limit.

Control Circuit Overview

The LM34922 buck regulator employs a control principle based on a comparator and a one-shot on-timer, with the output voltage feedback (FB) compared to an internal reference (2.51V). If the FB voltage is below the reference the internal buck switch is switched on for the one-shot timer period, which is a function of the input voltage and the programming resistor (R_T). Following the on-time the switch remains off until the FB voltage falls below the reference, but never less than the minimum off-time forced by the off-time one-shot timer. When the FB pin voltage falls below the reference and the off-time one-shot period expires, the buck switch is then turned on for another on-time one-shot period.

When in regulation, the LM34922 operates in continuous conduction mode at heavy load currents and discontinuous conduction mode at light load currents. In continuous conduction mode the inductor's current is always greater than zero, and the operating frequency remains relatively constant with load and line variations. The minimum load current for continuous conduction mode is one-half the inductor's ripple current amplitude. The approximate operating frequency is calculated as follows:

$$F_S = \frac{V_{OUT}}{(4.1 \times 10^{-11} \times (R_T + 0.5k)) + (V_{IN} \times 15 \text{ ns})} \quad (1)$$

The buck switch duty cycle is approximately equal to:

$$DC = \frac{t_{ON}}{t_{ON} + t_{OFF}} = t_{ON} \times F_S = \frac{V_{OUT}}{V_{IN}} \quad (2)$$

When the load current is less than one half the inductor's ripple current amplitude the circuit operates in discontinuous conduction mode. The off-time is longer than in continuous conduction mode while the inductor current is zero, causing the switching frequency to reduce as the load current is reduced. Conversion efficiency is maintained at light loads since the switching losses are reduced with the reduction in load and frequency. The approximate discontinuous operating frequency can be calculated as follows:

$$F_S = \frac{V_{OUT}^2 \times L1 \times 1.19 \times 10^{21}}{R_L \times R_T^2}$$

where

- R_L = the load resistance
 - $L1$ is the circuit's inductor
- (3)

The output voltage is set by the two feedback resistors (R_{FB1} , R_{FB2} in the Block Diagram). The regulated output voltage is calculated as follows:

$$V_{OUT} = 2.51V \times (R_{FB1} + R_{FB2}) / R_{FB1} \quad (4)$$

Ripple voltage, which is required at the input of the regulation comparator for proper output regulation, is generated internally in the LM34922. In the LM34922 the ERM (Emulated Ripple Mode) control circuit generates the required internal ripple voltage from the ripple waveform at the CS pin.

On-Time Timer

The on-time for the LM34922 is determined by the R_T resistor and the input voltage (V_{IN}), calculated from:

$$t_{ON} = \frac{4.1 \times 10^{-11} \times (R_T + 500\Omega)}{(V_{IN})} + 15 \text{ ns} \quad (5)$$

The inverse relationship with V_{IN} results in a nearly constant frequency as V_{IN} is varied. To set a specific continuous conduction mode switching frequency (F_S), the R_T resistor is determined from the following:

$$R_T = \frac{V_{OUT} - (V_{IN} \times F_S \times 15 \text{ ns})}{F_S \times 4.1 \times 10^{-11}} - 500\Omega \quad (6)$$

The on-time must be chosen greater than 90ns for proper operation. [Equation 1](#), [Equation 5](#) and [Equation 6](#) are valid only during normal operation - i.e., the circuit is not in current limit. When the LM34922 operates in current limit, the on-time is reduced by $\approx 40\%$. This feature reduces the peak inductor current which may be excessively high if the load current and the input voltage are simultaneously high. This feature operates on a cycle-by-cycle basis until the load current is reduced and the output voltage resumes its normal regulated value. The maximum continuous current into the RT pin must be less than 2mA. For high frequency applications, the maximum switching frequency is limited at the maximum input voltage by the minimum on-time one-shot period (90ns). At minimum input voltage the maximum switching frequency is limited by the minimum off-time one-shot period, which, if reached, prevents achievement of the proper duty cycle.

Current Limit

Current limit detection occurs during the off-time by monitoring the voltage across the external current sense resistor R_S . Referring to the [Block Diagram](#), during the off-time the recirculating current flows through the inductor, through the load, through the sense resistor, and through D1 to the inductor. If the voltage across the sense resistor exceeds the threshold (V_{LIM}) the current limit comparator output switches to delay the start of the next on-time period. The next on-time starts when the recirculating current decreases such that the voltage across R_S reduces to the threshold and the voltage at FB is below 2.51V. The operating frequency is typically lower due to longer-than-normal off-times. When current limit is detected, the on-time is reduced by $\approx 40\%$ if the voltage at the FB pin is below its threshold when the voltage across R_S reduces to its threshold (V_{OUT} is low due to current limiting).

[Figure 16](#) illustrates the inductor current waveform during normal operation and in current limit. During the first "Normal Operation" the load current is I_{O1} , the average of the inductor current waveform. As the load resistance is reduced, the inductor current increases until the lower peak of the inductor ripple current exceeds the threshold. During the "Current Limited" portion of [Figure 16](#), each on-time is reduced by $\approx 40\%$, resulting in lower ripple amplitude for the inductor's current. During this time the LM34922 is in a constant current mode with an average load current equal to the current limit threshold plus half the ripple amplitude (I_{OCL}), and the output voltage is below the normal regulated value. Normal operation resumes when the load current is reduced (to I_{O2}), allowing V_{OUT} and the on-time to return to their normal values. Note that in the second period of "Normal Operation", even though the inductor's peak current exceeds the current limit threshold during part of each cycle, the circuit is not in current limit since the inductor current falls below the current limit threshold during each off time. The peak current allowed through the buck switch is 3.5A, and the maximum allowed average current is 2.0A.

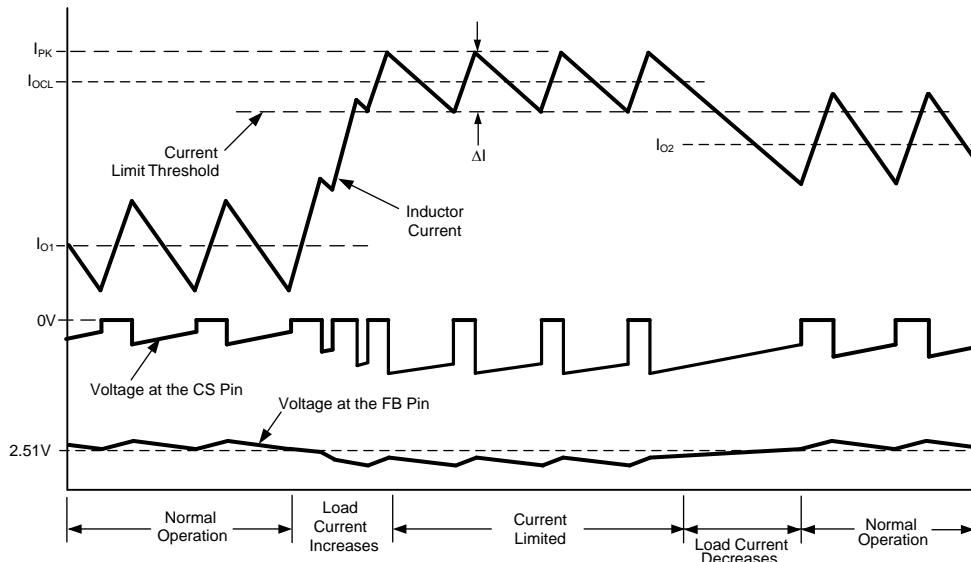

Figure 16. Normal and Current Limit Operation

Ripple Requirements

The LM34922 requires a minimum of 15mVp-p ripple voltage at the CS pin. That ripple voltage is generated by the decreasing recirculating current (the inductor's ripple current) through R_S during the off-time. See Figure 17.

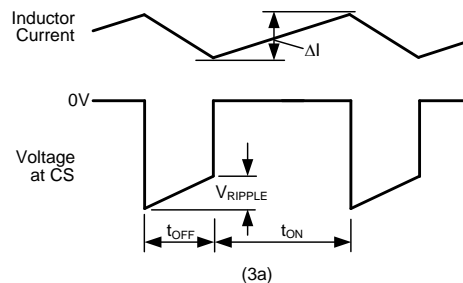

Figure 17. CS Pin Waveform

The ripple voltage is equal to:

$$V_{\text{RIPPLE}} = \Delta I \times R_S$$

where

- ΔI is the inductor current ripple amplitude
- R_S is the current sense resistor at the CS pin

(7)

N-Channel Buck Switch and Driver

The LM34922 integrates an N-Channel buck switch and associated floating high voltage gate driver. The gate driver circuit works in conjunction with an external bootstrap capacitor (C_{BST}) and an internal high voltage diode. A 0.1 μF capacitor connected between BST and SW provides the supply voltage for the driver during the on-time. During each off-time, the SW pin is at approximately -1V, and C_{BST} is recharged from the internal 5V regulator for the next on-time. The minimum off-time ensures a sufficient time each cycle to recharge the bootstrap capacitor.

Soft-Start

The soft-start feature allows the converter to gradually reach a steady state operating point, thereby reducing startup stresses and current surges. Upon turn-on, when V_{IN} reaches its under-voltage lock-out threshold an internal $10\mu\text{A}$ current source charges the external capacitor at the SS pin to 2.51V (t_1 in [Figure 15](#)). The ramping voltage at SS ramps the non-inverting input of the regulation comparator, and the output voltage, in a controlled manner. For proper operation, the soft-start capacitor should be no smaller than 1000pF .

The LM34922 can be employed as a tracking regulator by applying the controlling voltage to the SS pin. The regulator's output voltage tracks the applied voltage, gained up by the ratio of the feedback resistors. The applied voltage at the SS pin must be within the range of 0.5V to 2.6V . The absolute maximum rating for the SS pin is 3.0V . If the tracking function causes the voltage at the FB pin to go below the thresholds for the PGD pin, the PGD pin will switch low (see the [Power Good Output \(PGD\)](#) section). An internal switch grounds the SS pin if the input voltage at V_{IN} is below its under-voltage lock-out threshold or if the Thermal Shutdown activates. If the tracking function (described above) is used, the tracking voltage applied to the SS pin must be current limited to a maximum of 1mA .

Shutdown Function

The SS pin can be used to shutdown the LM34922 by grounding the SS pin as shown in [Figure 18](#). Releasing the pin allows normal operation to resume.

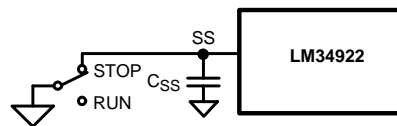

Figure 18. Shutdown Implementation

Power Good Output (PGD)

The Power Good output (PGD) indicates when the voltage at the FB pin is close to the internal 2.51V reference voltage. The rising threshold at the FB pin for the PGD output to switch high is 95% of the internal reference. The falling threshold for the PGD output to switch low is approximately 3.3% below the rising threshold.

The PGD pin is internally connected to the drain of an N-channel MOSFET switch. An external pull-up resistor (R_{PGD}), connected to an appropriate voltage not exceeding 7V , is required at PGD to indicate the LM34922's status to other circuitry. When PGD is low, the pin's voltage is determined by the current into the pin. See the graph "[PGD Low Voltage vs. Sink Current](#)".

Upon powering up the LM34922, the PGD pin is high until the voltage at V_{IN} reaches 2V , at which time PGD switches low. As V_{IN} is increased PGD stays low until the output voltage takes the voltage at the FB pin above 95% of the internal reference voltage, at which time PGD switches high. As V_{IN} is decreased (during shutdown) PGD remains high until either the voltage at the FB pin falls below $\approx 92\%$ of the internal reference, or when V_{IN} falls below its lower UVLO threshold, whichever occurs first. PGD then switches low, and remains low until V_{IN} falls below 2V , at which time PGD switches high. If the LM34922 is used as a tracking regulator (see the [Soft-Start](#) section), the PGD output is high as long as the voltage at the FB pin is above the thresholds mentioned above.

Thermal Shutdown

The LM34922 should be operated so the junction temperature does not exceed 125°C . If the junction temperature increases above that, an internal Thermal Shutdown circuit activates (typically) at 155°C , taking the controller to a low power reset state by disabling the buck switch and taking the SS pin to ground. This feature helps prevent catastrophic failures from accidental device overheating. When the junction temperature reduces below 135°C (typical hysteresis = 20°C) normal operation resumes.

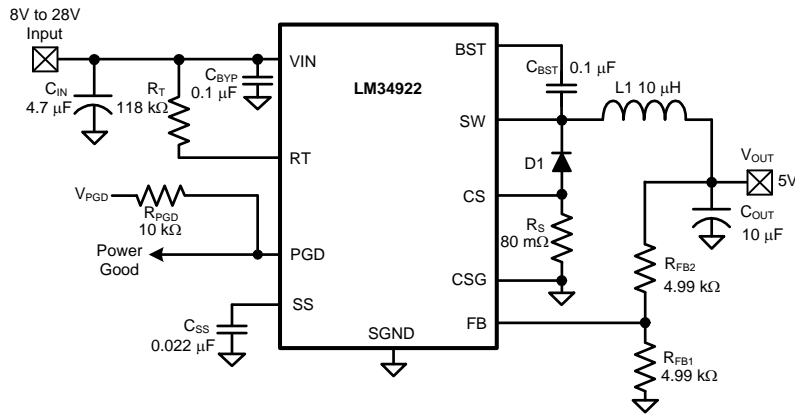

Figure 19. Example Circuit

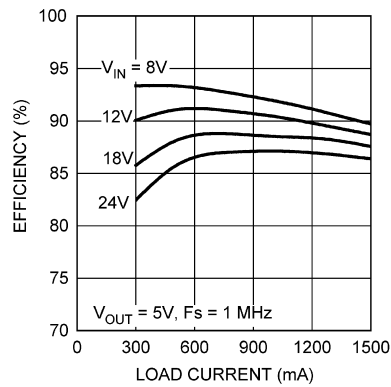

Figure 20. Efficiency (Circuit of Figure 19)

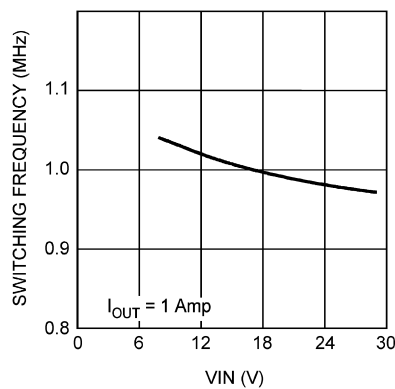

Figure 21. Frequency vs V_{IN} (Circuit of Figure 19)

REVISION HISTORY

Changes from Original (March 2013) to Revision A	Page
• Changed layout of National Data Sheet to TI format	13

PACKAGING INFORMATION

Orderable Device	Status (1)	Package Type	Package Drawing	Pins	Package Qty	Eco Plan (2)	Lead/Ball Finish (6)	MSL Peak Temp (3)	Op Temp (°C)	Device Marking (4/5)	Samples
LM34922MY/NOPB	ACTIVE	HVSSOP	DGQ	10	1000	Green (RoHS & no Sb/Br)	SN	Level-3-260C-168 HR	-40 to 125	SA8B	Samples
LM34922MYX/NOPB	ACTIVE	HVSSOP	DGQ	10	3500	Green (RoHS & no Sb/Br)	SN	Level-3-260C-168 HR	-40 to 125	SA8B	Samples

(1) The marketing status values are defined as follows:

ACTIVE: Product device recommended for new designs.

LIFEBUY: TI has announced that the device will be discontinued, and a lifetime-buy period is in effect.

NRND: Not recommended for new designs. Device is in production to support existing customers, but TI does not recommend using this part in a new design.

PREVIEW: Device has been announced but is not in production. Samples may or may not be available.

OBsolete: TI has discontinued the production of the device.

(2) **RoHS:** TI defines "RoHS" to mean semiconductor products that are compliant with the current EU RoHS requirements for all 10 RoHS substances, including the requirement that RoHS substance do not exceed 0.1% by weight in homogeneous materials. Where designed to be soldered at high temperatures, "RoHS" products are suitable for use in specified lead-free processes. TI may reference these types of products as "Pb-Free".

RoHS Exempt: TI defines "RoHS Exempt" to mean products that contain lead but are compliant with EU RoHS pursuant to a specific EU RoHS exemption.

Green: TI defines "Green" to mean the content of Chlorine (Cl) and Bromine (Br) based flame retardants meet JS709B low halogen requirements of <=1000ppm threshold. Antimony trioxide based flame retardants must also meet the <=1000ppm threshold requirement.

(3) MSL, Peak Temp. - The Moisture Sensitivity Level rating according to the JEDEC industry standard classifications, and peak solder temperature.

(4) There may be additional marking, which relates to the logo, the lot trace code information, or the environmental category on the device.

(5) Multiple Device Markings will be inside parentheses. Only one Device Marking contained in parentheses and separated by a "~" will appear on a device. If a line is indented then it is a continuation of the previous line and the two combined represent the entire Device Marking for that device.

(6) Lead/Ball Finish - Orderable Devices may have multiple material finish options. Finish options are separated by a vertical ruled line. Lead/Ball Finish values may wrap to two lines if the finish value exceeds the maximum column width.

Important Information and Disclaimer:The information provided on this page represents TI's knowledge and belief as of the date that it is provided. TI bases its knowledge and belief on information provided by third parties, and makes no representation or warranty as to the accuracy of such information. Efforts are underway to better integrate information from third parties. TI has taken and continues to take reasonable steps to provide representative and accurate information but may not have conducted destructive testing or chemical analysis on incoming materials and chemicals. TI and TI suppliers consider certain information to be proprietary, and thus CAS numbers and other limited information may not be available for release.

In no event shall TI's liability arising out of such information exceed the total purchase price of the TI part(s) at issue in this document sold by TI to Customer on an annual basis.

TAPE AND REEL INFORMATION



QUADRANT ASSIGNMENTS FOR PIN 1 ORIENTATION IN TAPE



*All dimensions are nominal

Device	Package Type	Package Drawing	Pins	SPQ	Reel Diameter (mm)	Reel Width W1 (mm)	A0 (mm)	B0 (mm)	K0 (mm)	P1 (mm)	W (mm)	Pin1 Quadrant
LM34922MY/NOPB	HVSSOP	DGQ	10	1000	178.0	12.4	5.3	3.4	1.4	8.0	12.0	Q1
LM34922MYX/NOPB	HVSSOP	DGQ	10	3500	330.0	12.4	5.3	3.4	1.4	8.0	12.0	Q1

TAPE AND REEL BOX DIMENSIONS

*All dimensions are nominal

Device	Package Type	Package Drawing	Pins	SPQ	Length (mm)	Width (mm)	Height (mm)
LM34922MY/NOPB	HVSSOP	DGQ	10	1000	210.0	185.0	35.0
LM34922MYX/NOPB	HVSSOP	DGQ	10	3500	367.0	367.0	35.0

DGQ0010A

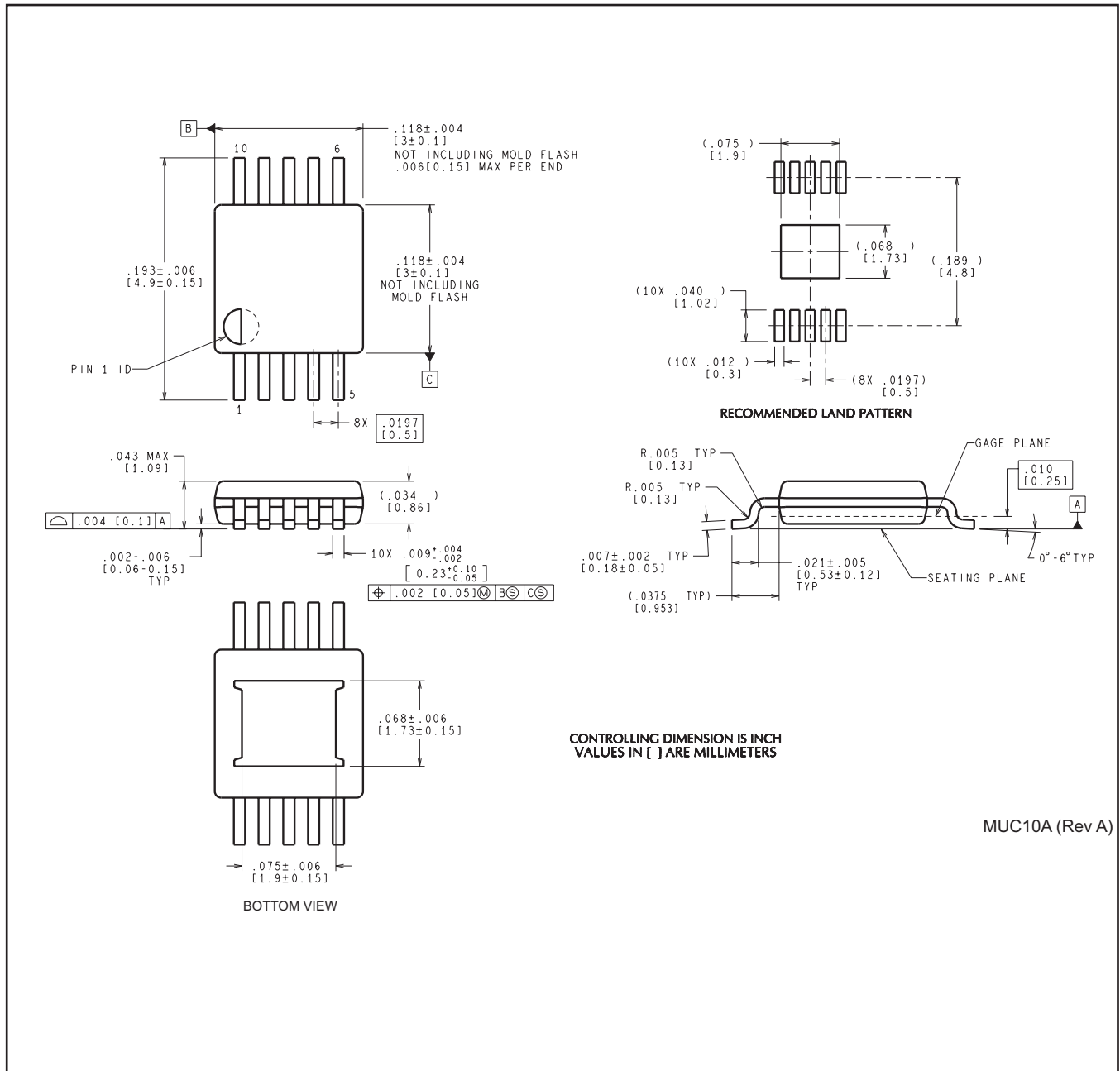

IMPORTANT NOTICE AND DISCLAIMER

TI PROVIDES TECHNICAL AND RELIABILITY DATA (INCLUDING DATASHEETS), DESIGN RESOURCES (INCLUDING REFERENCE DESIGNS), APPLICATION OR OTHER DESIGN ADVICE, WEB TOOLS, SAFETY INFORMATION, AND OTHER RESOURCES "AS IS" AND WITH ALL FAULTS, AND DISCLAIMS ALL WARRANTIES, EXPRESS AND IMPLIED, INCLUDING WITHOUT LIMITATION ANY IMPLIED WARRANTIES OF MERCHANTABILITY, FITNESS FOR A PARTICULAR PURPOSE OR NON-INFRINGEMENT OF THIRD PARTY INTELLECTUAL PROPERTY RIGHTS.

These resources are intended for skilled developers designing with TI products. You are solely responsible for (1) selecting the appropriate TI products for your application, (2) designing, validating and testing your application, and (3) ensuring your application meets applicable standards, and any other safety, security, or other requirements. These resources are subject to change without notice. TI grants you permission to use these resources only for development of an application that uses the TI products described in the resource. Other reproduction and display of these resources is prohibited. No license is granted to any other TI intellectual property right or to any third party intellectual property right. TI disclaims responsibility for, and you will fully indemnify TI and its representatives against, any claims, damages, costs, losses, and liabilities arising out of your use of these resources.

TI's products are provided subject to TI's Terms of Sale (www.ti.com/legal/termsofsale.html) or other applicable terms available either on ti.com or provided in conjunction with such TI products. TI's provision of these resources does not expand or otherwise alter TI's applicable warranties or warranty disclaimers for TI products.

Mailing Address: Texas Instruments, Post Office Box 655303, Dallas, Texas 75265
Copyright © 2020, Texas Instruments Incorporated