

## LM3674

### 2MHz, 600mA Step-Down DC-DC Converter in SOT 23-5

#### General Description

The LM3674 step-down DC-DC converter is optimized for powering low voltage circuits from a single Li-Ion cell battery and input voltage rails from 2.7V to 5.5V. It provides up to 600mA load current, over the entire input voltage range. There are several fixed output voltages and adjustable output voltage versions.

The device offers superior features and performance for mobile phones and similar portable systems. During PWM mode, the device operates at a fixed-frequency of 2 MHz (typ). Internal synchronous rectification provides high efficiency during PWM mode operation. In shutdown mode, the device turns off and reduces battery consumption to 0.01  $\mu$ A (typ).

The LM3674 is available in SOT23-5 in leaded (PB) and lead-free (NO PB) versions. A high switching frequency of 2 MHz (typ) allows use of only three tiny external surface-mount components, an inductor and two ceramic capacitors.

#### Features

- 600mA max load current
- Input voltage range from 2.7V to 5.5V
- Available in fixed and adjustable output voltages ranging from 1.0V to 3.3V
- Operates from a single Li-Ion cell Battery
- Internal synchronous rectification for high efficiency
- Internal soft start
- 0.01  $\mu$ A typical shutdown current
- 2 MHz PWM fixed switching frequency (typ)
- SOT23-5 package
- Current overload protection and Thermal shutdown protection

#### Applications

- Mobile phones
- PDAs
- MP3 players
- Portable instruments
- W-LAN
- Digital still cameras
- Portable Hard disk drives

#### Typical Application

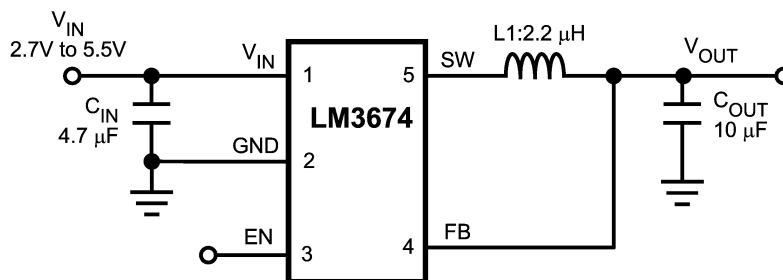

20167201

FIGURE 1. Typical Application Circuit

## Typical Application (Continued)

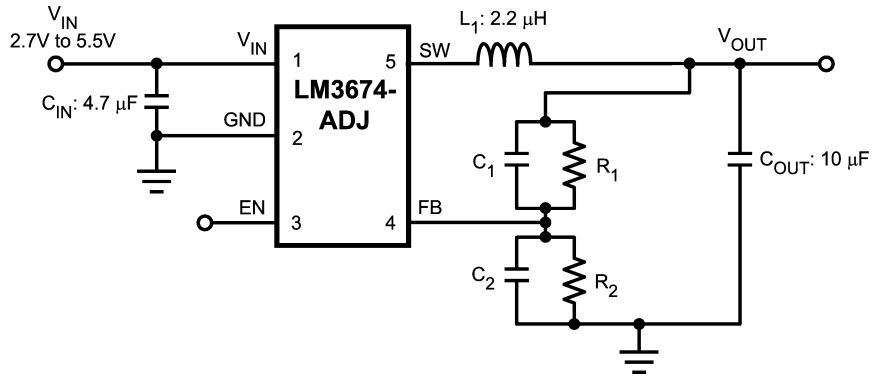

20167230

FIGURE 2. Typical Application Circuit

## Connection Diagram and Package Mark Information

SOT23-5 Package  
NS Package Number MF05A

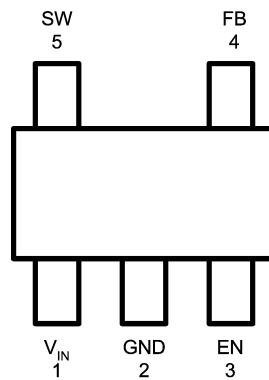

20167202

**Note:** The actual physical placement of the package marking will vary from part to part.

FIGURE 3. Top View

## Pin Descriptions

Pin #	Name	Description
1	$V_{IN}$	Power supply input. Connect to the input filter capacitor ( <i>Figure 1</i> ).
2	GND	Ground pin.
3	EN	Enable input. The device is in shutdown mode when voltage to this pin is $<0.4V$ and enable when $>1.0V$ . Do not leave this pin floating.
4	FB	Feedback analog input. Connect to the output filter capacitor for fixed voltage versions. For adjustable version external resistor dividers are required ( <i>Figure 2</i> ). The internal resistor dividers are disabled for the adjustable version.
5	SW	Switching node connection to the internal PFET switch and NFET synchronous rectifier.

## Ordering Information

Voltage Option (V)	Order Number (Level 95)	SPEC	Package Marking	Supplied As (#/reel)
1.2	LM3674MF-1.2	NO PB	SLRB	1000
	LM3674MFX-1.2	NO PB		3000
	LM3674MF-1.2			1000
	LM3674MFX-1.2			3000
1.5	LM3674MF-1.5	NO PB	SLSB	1000
	LM3674MFX-1.5	NO PB		3000
	LM3674MF-1.5			1000
	LM3674MFX-1.5			3000
1.8	LM3674MF-1.8	NO PB	SLHB	1000
	LM3674MFX-1.8	NO PB		3000
	LM3674MF-1.8			1000
	LM3674MFX-1.8			3000
ADJ	LM3674MF-ADJ	NO PB	SLTB	1000
	LM3674MFX-ADJ	NO PB		3000
	LM3674MF-ADJ			1000
	LM3674MFX-ADJ			3000

**Absolute Maximum Ratings** (Note 1)

If Military/Aerospace specified devices are required, please contact the National Semiconductor Sales Office/Distributors for availability and specifications.

$V_{IN}$ Pin: Voltage to GND	-0.2V to 6.0V
EN, FB, SW Pin:	(GND-0.2V) to ( $V_{IN} + 0.2V$ )
Continuous Power Dissipation	Internally Limited
Junction Temperature ( $T_{J-MAX}$ )	+125°C
Storage Temperature Range	-65°C to +150°C
Maximum Lead Temperature (Soldering, 10 sec.)	260°C
ESD Rating (Note 3)	
Human Body model: All Pins	2 kV
Machine Model: All Pins	200V

**Operating Ratings** (Notes 1, 2)

Input Voltage Range (Note 11)	2.7V to 5.5V
Recommended Load Current	0A to 600 mA
Junction Temperature ( $T_J$ ) Range	-30°C to +125°C
Ambient Temperature ( $T_A$ ) Range	-30°C to +85°C

**Thermal Properties**

Junction-to-Ambient Thermal Resistance ( $\theta_{JA}$ ) (SOT23-5) for a 2 layer board (Note 6)	Junction-to-Ambient Thermal Resistance ( $\theta_{JA}$ ) (SOT23-5) for a 4 layer board (Note 6)
250°C/W	130°C/W

**Electrical Characteristics** (Notes 2, 9, 10) Limits in standard typeface are for  $T_J = 25^\circ\text{C}$ . Limits in **boldface** type apply over the full operating junction temperature range ( $-30^\circ\text{C} \leq T_J \leq 125^\circ\text{C}$ ). Unless otherwise noted, specifications apply to the LM3674 with  $V_{IN} = EN = 3.6V$

Symbol	Parameter	Condition	Min	Typ	Max	Units
$V_{FB}$	Feedback Voltage (Note 12)	$I_O = 10\text{mA}$	<b>-4</b>		<b>+4</b>	%
	Line Regulation	$2.7V \leq V_{IN} \leq 5.5V$ $I_O = 100\text{mA}$		0.083		%/V
	Load Regulation	$100\text{mA} \leq I_O \leq 600\text{mA}$ $V_{IN} = 3.6V$		0.0010		%/mA
$V_{REF}$	Internal Reference Voltage	(Note 7)		0.5		V
$I_{SHDN}$	Shutdown Supply Current	EN = 0V		0.01	<b>1</b>	$\mu\text{A}$
$I_Q$	DC Bias Current into $V_{IN}$	No load, device is not switching (FB=0V)		300	<b>600</b>	$\mu\text{A}$
$R_{DSON(P)}$	Pin-Pin Resistance for PFET	$I_{SW} = 200\text{mA}$		380	500	m $\Omega$
$R_{DSON(N)}$	Pin-Pin Resistance for NFET	$I_{SW} = 200\text{mA}$		250	400	m $\Omega$
$I_{LIM}$	Switch Peak Current Limit	Open Loop (Note 8)	<b>830</b>	1020	<b>1200</b>	mA
$V_{IH}$	Logic High Input		<b>1.0</b>			V
$V_{IL}$	Logic Low Input				<b>0.4</b>	V
$I_{EN}$	Enable (EN) Input Current			0.01	<b>1</b>	$\mu\text{A}$
$F_{OSC}$	Internal Oscillator Frequency	PWM Mode	<b>1.6</b>	2	<b>2.6</b>	MHz

**Note 1:** Absolute Maximum Ratings indicate limits beyond which damage to the device may occur. Operating Ratings are conditions under which operation of the device is guaranteed. Operating Ratings do not imply guaranteed performance limits. For guaranteed performance limits and associated test conditions, see the Electrical Characteristics tables.

**Note 2:** All voltages are with respect to the potential at the GND pin.

**Note 3:** The Human body model is a 100 pF capacitor discharged through a 1.5 k $\Omega$  resistor into each pin. The machine model is a 200 pF capacitor discharged directly into each pin (MIL-STD-883 3015.7). National Semiconductor recommends that all integrated circuits be handled with appropriate precautions. Failure to observe proper ESD handling techniques can result in damage.

**Note 4:** Internal thermal shutdown circuitry protects the device from permanent damage. Thermal shutdown engages at  $T_J = 150^\circ\text{C}$  (typ.) and disengages at  $T_J = 130^\circ\text{C}$

**Note 5:** In Applications where high power dissipation and /or poor package resistance is present, the maximum ambient temperature may have to be derated. Maximum ambient temperature ( $T_{A-MAX}$ ) is dependent on the maximum operating junction temperature ( $T_{J-MAX}$ ), the maximum power dissipation of the device in the application ( $P_{D-MAX}$ ) and the junction to ambient thermal resistance of the package ( $\theta_{JA}$ ) in the application, as given by the following equation:  $T_{A-MAX} = T_{J-MAX} - (\theta_{JA} \times P_{D-MAX})$ . Refer to Dissipation ration table for  $P_{D-MAX}$  values at different ambient temperatures.

**Note 6:** Junction to ambient thermal resistance is highly application and board layout dependent. In applications where high power dissipation exists, special care must be given to thermal dissipation issues in board design. Value specified here 250°C/W is based on measurement results using a 2 layer, 4" X 3", 2 oz. Cu board as per JEDEC standards. The ( $\theta_{JA}$ ) is 130°C/W if a 4 layer, 4" X 3", 2/1/1/2 oz. Cu board as per JEDEC standards is used.

**Note 7:** For the ADJ version the resistor dividers should be selected such that at the desired output voltage, the voltage at the FB pin is 0.5V.

**Note 8:** Refer to datasheet curves for closed loop data and its variation with regards to supply voltage and temperature. Electrical Characteristic table reflects open loop data (FB=0V and current drawn from SW pin ramped up until cycle by cycle current limit is activated). Closed loop current limit is the peak inductor current measured in the application circuit by increasing output current until output voltage drops by 10%.

**Note 9:** Min and Max limits are guaranteed by design, test or statistical analysis. Typical numbers are not guaranteed, but do represent the most likely norm.

**Note 10:** The parameters in the electrical characteristic table are tested at  $V_{IN} = 3.6V$  unless otherwise specified. For performance over the input voltage range refer to datasheet curves.

**Electrical Characteristics** (Notes 2, 9, 10) Limits in standard typeface are for  $T_J = 25^\circ\text{C}$ . Limits in **boldface** type apply over the full operating junction temperature range ( $-30^\circ\text{C} \leq T_J \leq 125^\circ\text{C}$ ). Unless otherwise noted, specifications apply to the LM3674 with  $V_{IN} = EN = 3.6\text{V}$  (Continued)

**Note 11:** Input voltage range recommended for ideal applications performance for the specified output voltages are given below

$$V_{IN} = 2.7\text{V to } 5.5\text{V for } 1.0\text{V} \leq V_{OUT} < 1.8\text{V}$$

$$V_{IN} = (V_{OUT} + V_{DROPOUT}) \text{ to } 5.5\text{V for } 1.8 \leq V_{OUT} \leq 3.3\text{V}$$

$$\text{Where } V_{DROPOUT} = I_{LOAD} * (R_{DS(ON)}(P) + R_{INDUCTOR})$$

**Note 12:** Feedback voltage specification for ADJ include the tolerances of the resistor divider network. ADJ configured to 1.5V output.

## Dissipation Rating Table

$\theta_{JA}$	<b><math>T_A \leq 25^\circ\text{C}</math> (Power Rating)</b>	<b><math>T_A = 60^\circ\text{C}</math> (Power Rating)</b>	<b><math>T_A = 85^\circ\text{C}</math> (Power Rating)</b>
250°C/W (2 layer board)	400mW	260mW	160mW
130°C/W (4 layer board)	770mW	500mW	310mW

# Block Diagram

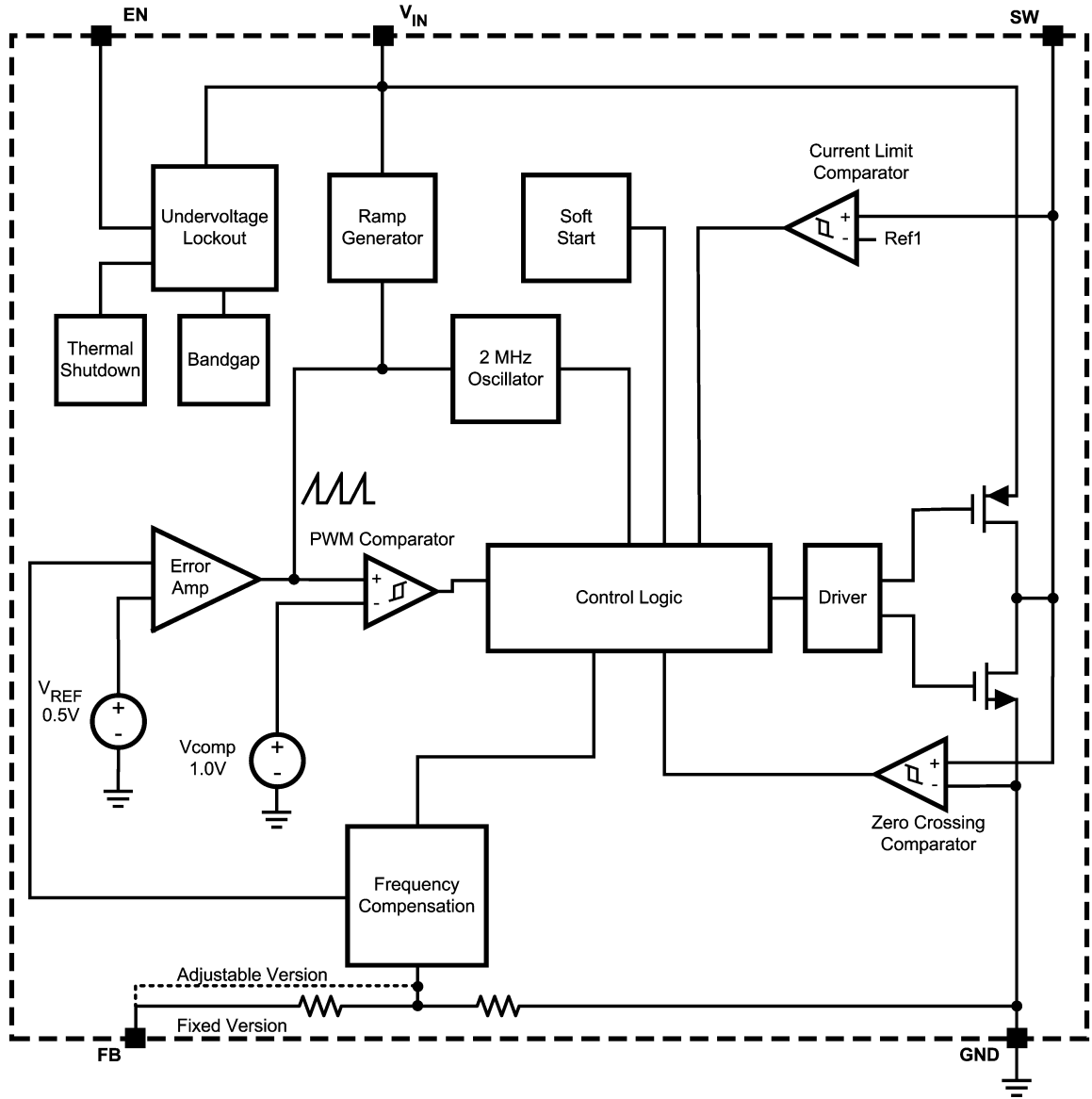
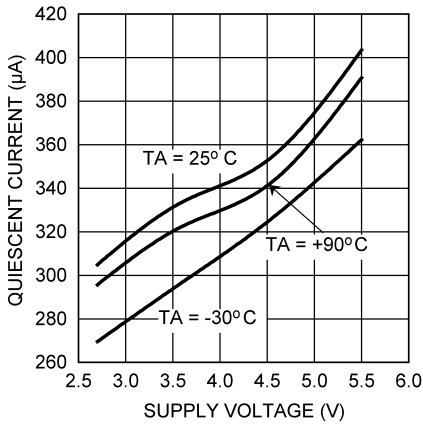

FIGURE 4. Simplified Functional Diagram

**Typical Performance Characteristics** (unless otherwise stated:  $V_{IN} = 3.6V$ ,  $V_{OUT} = 1.5V$ ,  $T_A = 25^\circ C$ )

**Quiescent Current vs. Supply Voltage**  
(FB = 0V, No Switching)



20167244

**I<sub>Q</sub> Shutdown vs. Temp**

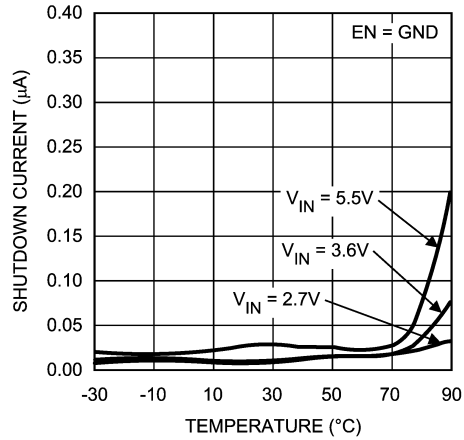

20167205

**Feedback Bias Current vs. Temp**

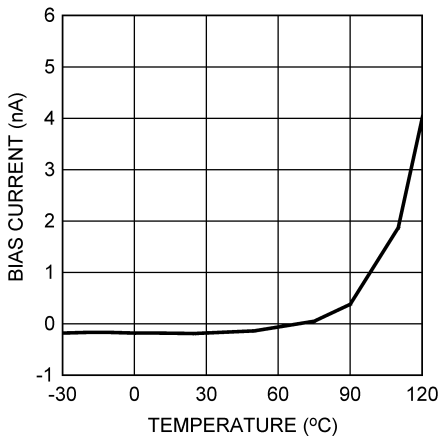

20167206

**Output Voltage vs. Supply Voltage**

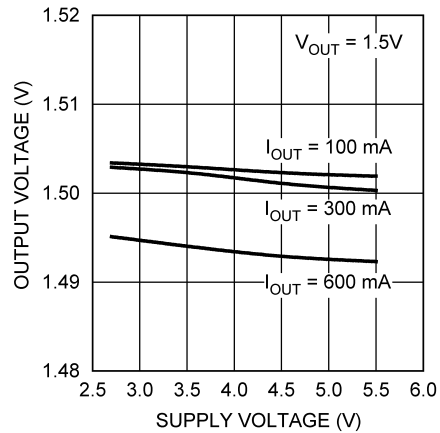

20167265

**Output Voltage vs. Temperature**

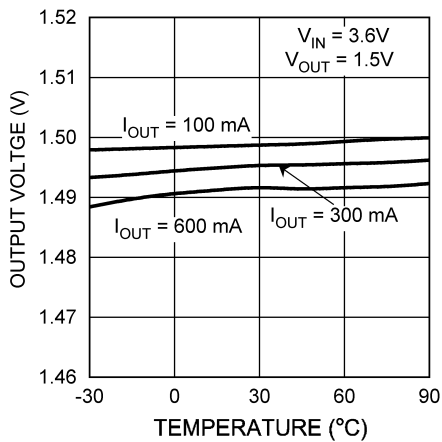

20167298

**Output Voltage vs. Output Current**

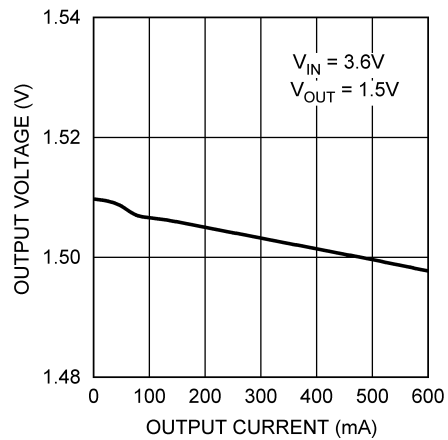

20167266

**Typical Performance Characteristics** (unless otherwise stated:  $V_{IN} = 3.6V$ ,  $V_{OUT} = 1.5V$ ,  $T_A = 25^\circ C$ ) (Continued)

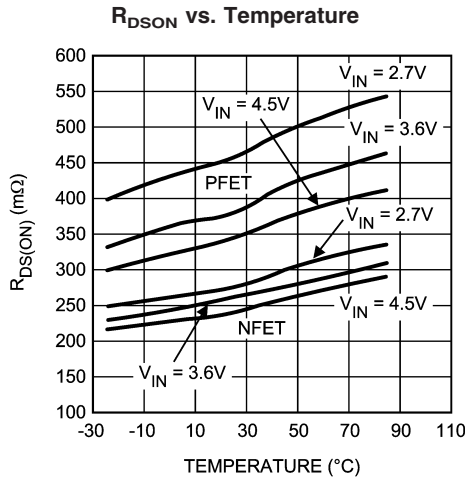

20167210

**Efficiency vs. Output Current**  
( $V_{OUT} = 1.2V$ ,  $L = 2.2\mu H$ ,  $DCR = 200m\Omega$ )

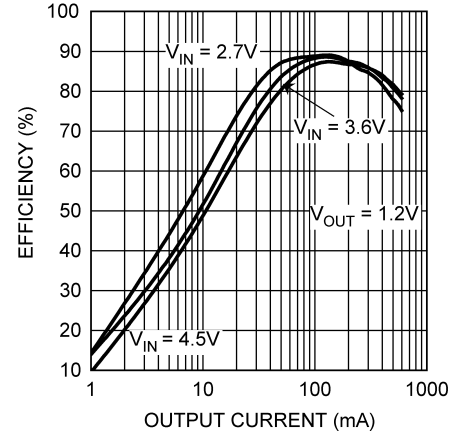

20167267

**Efficiency vs. Output Current**  
( $V_{OUT} = 1.5V$ ,  $L = 2.2\mu H$ ,  $DCR = 200m\Omega$ )

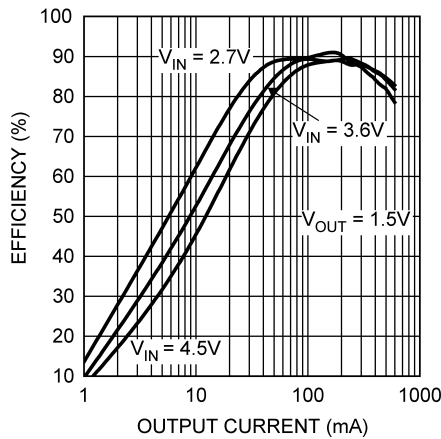

20167268

**Efficiency vs. Output Current**  
( $V_{OUT} = 1.8V$ ,  $L = 2.2\mu H$ ,  $DCR = 200m\Omega$ )

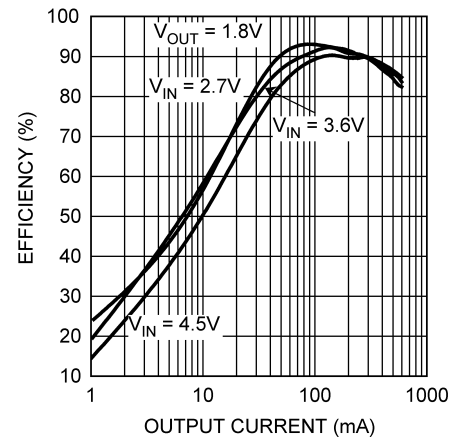

20167269

**Efficiency vs. Output Current**  
( $V_{OUT} = 3.3V$ ,  $L = 2.2\mu H$ ,  $DCR = 200m\Omega$ )

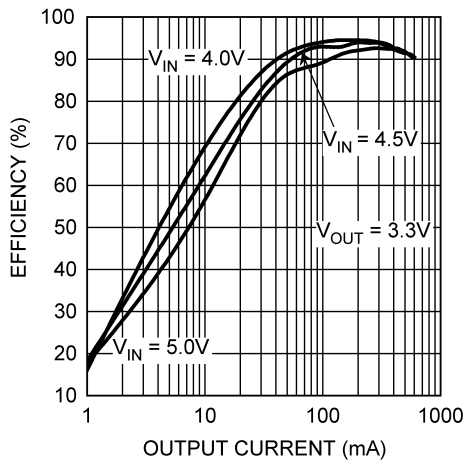

20167299

**Switching Frequency vs. Temperature**

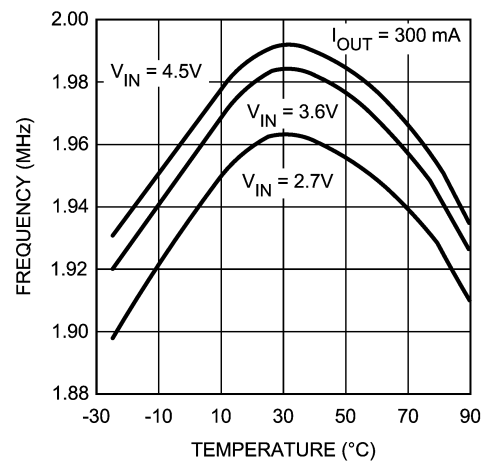

20167216



**Typical Performance Characteristics** (unless otherwise stated:  $V_{IN} = 3.6V$ ,  $V_{OUT} = 1.5V$ ,  $T_A = 25^\circ C$ ) (Continued)

**Open/Closed Loop Current Limit vs. Temperature**

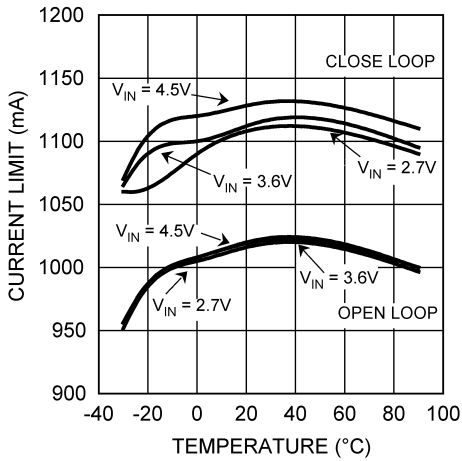

20167297

**Line Transient Response**

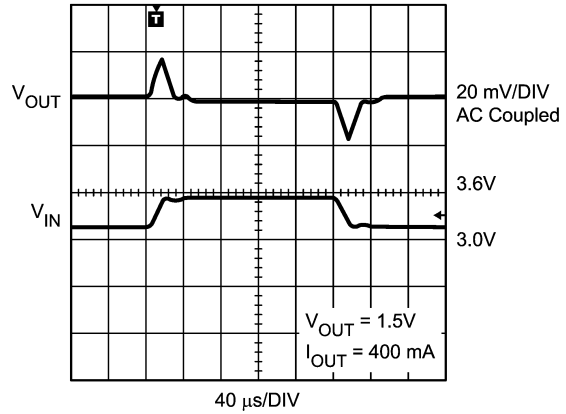

20167218

**Load Transient**

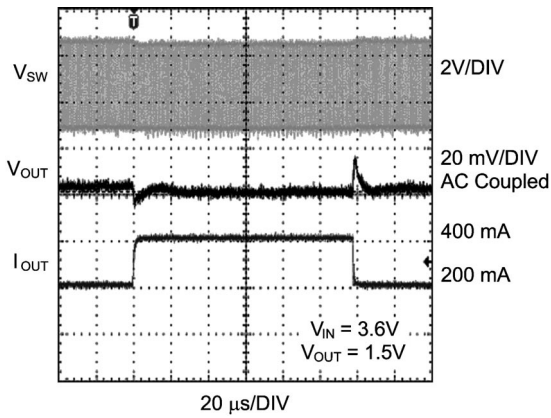

20167247

**Start Up (Output Current = 300mA)**

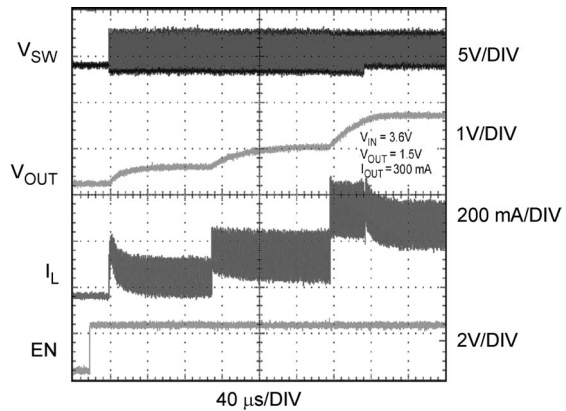

20167223

**Start Up (Output Current = 10mA)**

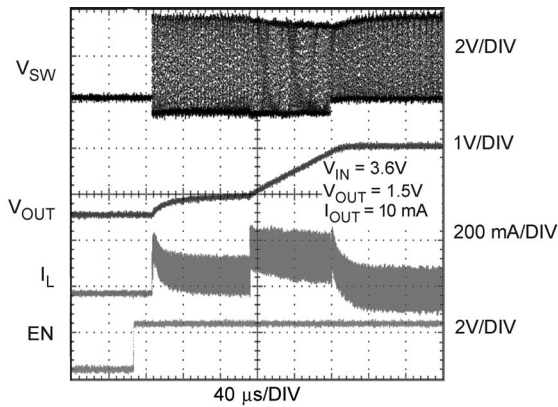

20167224

## Operation Description

### DEVICE INFORMATION

The LM3674, a high efficiency step down DC-DC switching buck converter, delivers a constant voltage from a single Li-Ion battery and input voltage rails from 2.7V to 5.5V to portable devices such as cell phones and PDAs. Using a voltage mode architecture with synchronous rectification, the LM3674 has the ability to deliver up to 600 mA depending on the input voltage, output voltage, ambient temperature and the inductor chosen.

There are two modes of operation depending on the current required - PWM (Pulse Width Modulation), and shutdown. The device operates in PWM throughout the  $I_{OUT}$  range. Shutdown mode turns off the device, offering the lowest current consumption ( $I_{SHUTDOWN} = 0.01 \mu\text{A typ}$ ).

Additional features include soft-start, under voltage protection, current overload protection, and thermal overload protection. As shown in *Figure 1*, only three external power components are required for implementation.

The part uses an internal reference voltage of 0.5V. It is recommended to keep the part in shutdown until the input voltage is 2.7V or higher.

### CIRCUIT OPERATION

During the first portion of each switching cycle, the control block in the LM3674 turns on the internal PFET switch. This allows current to flow from the input through the inductor to the output filter capacitor and load. The inductor limits the current to a ramp with a slope of

$$\frac{V_{IN} - V_{OUT}}{L}$$

by storing energy in a magnetic field. During the second portion of each cycle, the controller turns the PFET switch off, blocking current flow from the input, and then turns the NFET synchronous rectifier on. The inductor draws current from ground through the NFET to the output filter capacitor and load, which ramps the inductor current down with a slope of

$$\frac{-V_{OUT}}{L}$$

The output filter stores charge when the inductor current is high, and releases it when the inductor current is low, smoothing the voltage across the load.

The output voltage is regulated by modulating the PFET switch on time to control the average current sent to the load. The effect is identical to sending a duty-cycle modulated rectangular wave formed by the switch and synchronous rectifier at the SW pin to a low-pass filter formed by the inductor and output filter capacitor. The output voltage is equal to the average voltage at the SW pin.

### PWM OPERATION

During PWM (Pulse Width Modulation) operation the converter operates as a voltage-mode controller with input voltage feed forward. This allows the converter to achieve excellent load and line regulation. The DC gain of the power

stage is proportional to the input voltage. To eliminate this dependence, feed forward inversely proportional to the input voltage is introduced.

While in PWM mode, the output voltage is regulated by switching at a constant frequency and then modulating the energy per cycle to control power to the load. At the beginning of each clock cycle the PFET switch is turned on and the inductor current ramps up until the comparator trips and the control logic turns off the switch.

The current limit comparator can also turn off the switch in case the current limit of the PFET is exceeded. Then the NFET switch is turned on and the inductor current ramps down. The next cycle is initiated by the clock turning off the NFET and turning on the PFET.

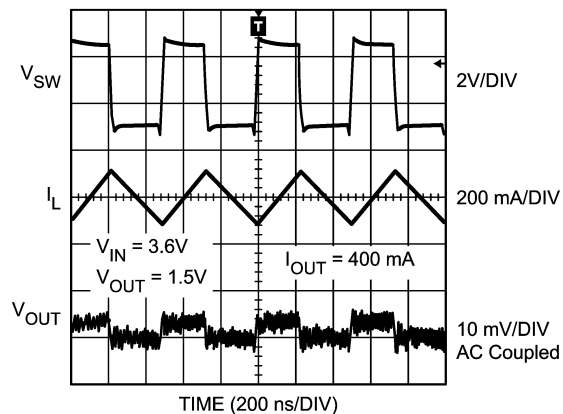

20167275

### Internal Synchronous Rectification

While in PWM mode, the LM3674 uses an internal NFET as a synchronous rectifier to reduce rectifier forward voltage drop and associated power loss. Synchronous rectification provides a significant improvement in efficiency whenever the output voltage is relatively low compared to the voltage drop across an ordinary rectifier diode.

### Current Limiting

A current limit feature allows the LM3674 to protect itself and external components during overload conditions. PWM mode implements current limiting using an internal comparator that trips at 1020 mA (typ). If the output is shorted to ground the device enters a timed current limit mode where the NFET is turned on for a longer duration until the inductor current falls below a low threshold, ensuring inductor current has more time to decay, thereby preventing runaway.

### SOFT-START

The LM3674 has a soft-start circuit that limits in-rush current during start-up. During start-up the switch current limit is increased in steps. Soft start is activated only if EN goes from logic low to logic high after  $V_{IN}$  reaches 2.7V. Soft start is implemented by increasing switch current limit in steps of 70mA, 140mA, 280mA, and 1020mA (typ. switch current limit). The start-up time thereby depends on the output capacitor and load current demanded at start-up. Typical start-up times with 10 $\mu\text{F}$  output capacitor and 300mA load current is 350 $\mu\text{s}$  and with 10mA load current is 240 $\mu\text{s}$ .

### LDO - LOW DROP OUT OPERATION

The LM3674-ADJ can operate at 100% duty cycle (no switching, PMOS switch completely on) for low drop out support of the output voltage. In this way the output voltage

## Operation Description (Continued)

will be controlled down to the lowest possible input voltage. When the device operates near 100% duty cycle, the output voltage supply ripple is slightly higher, approximately 25mV. The minimum input voltage needed to support the output voltage is

$$V_{IN,MIN} = I_{LOAD} * (R_{DSON,PFET} + R_{INDUCTOR}) + V_{OUT}$$

- $I_{LOAD}$  Load current
- $R_{DSON,PFET}$  Drain to source resistance of PFET switch in the triode region
- $R_{INDUCTOR}$  Inductor resistance

## Application Information

### OUTPUT VOLTAGE SELECTION FOR ADJUSTABLE (LM3674-ADJ)

The output voltage of the adjustable parts can be programmed through the resistor network connected from  $V_{OUT}$  to FB the to GND.  $V_{OUT}$  will be adjusted to make FB equal to 0.5V. The resistor from FB to GND ( $R_2$ ) should be 200 k $\Omega$  to keep the current drawn through this network small but large enough that it is not susceptible to noise. If  $R_2$  is 200K $\Omega$ , and given the  $V_{FB}$  is 0.5V, then the current through the resistor feedback network will be 2.5 $\mu$ A. The output voltage formula is:

$$V_{OUT} = V_{FB} * \left( \frac{R_1}{R_2} + 1 \right)$$

- $V_{OUT}$  = Output Voltage (V)

TABLE 1. Adjustable LM3674 Configurations for Various  $V_{OUT}$

VOUT (V)	R1 (K $\Omega$ )	R2 (K $\Omega$ )	C1 (pF)	C2 (pF)	L ( $\mu$ H)	CIN ( $\mu$ F)	COU ( $\mu$ F)
1.0	200	200	18	None	2.2	4.7	10
1.1	191	158	18	None	2.2	4.7	10
1.2	280	200	12	None	2.2	4.7	10
1.5	357	178	10	None	2.2	4.7	10
1.6	442	200	8.2	None	2.2	4.7	10
1.7	432	178	8.2	None	2.2	4.7	10
1.8	464	178	8.2	None	2.2	4.7	10
1.875	523	191	6.8	None	2.2	4.7	10
2.5	402	100	8.2	None	2.2	4.7	10
2.8	464	100	8.2	33	2.2	4.7	10
3.3	562	100	6.8	33	2.2	4.7	10

### INDUCTOR SELECTION

There are two main considerations when choosing an inductor; the inductor should not saturate, and the inductor current ripple should be small enough to achieve the desired output voltage ripple. Different saturation current rating specifications are followed by different manufacturers so attention must be given to details. Saturation current ratings are typically specified at 25°C. However, ratings at the maximum ambient temperature of application should be requested from the manufacturer. **The minimum value of inductance**

- $V_{FB}$  = Feedback Voltage (0.5V typ)
- $R_1$  = Resistor from  $V_{OUT}$  to FB ( $\Omega$ )
- $R_2$  = Resistor from FB to GND ( $\Omega$ )

For any output voltage greater than or equal to 1.0V a frequency zero must be added at 45KHz for stability. The formula is:

$$C_1 = \frac{1}{2 \times \pi \times R_1 \times 45 \text{ kHz}}$$

For output voltages greater than or equal to 2.5V, a pole must also be placed at 45KHz as well. If the pole and zero are at the same frequency the formula for calculation of  $C_2$  is:

$$C_2 = \frac{1}{2 \times \pi \times R_2 \times 45 \text{ kHz}}$$

The formula for location of zero and pole frequency created by adding  $C_1, C_2$  are given below. It can be seen that by adding  $C_1$ , a zero as well as a higher frequency pole is introduced.

$$F_z = \frac{1}{(2 * \pi * R_1 * C_1)}$$

$$F_p = \frac{1}{2 * \pi * (R_1 || R_2) * (C_1 + C_2)}$$

See the " LM3674-ADJ Configurations for " Various  $V_{OUT}$ " table.

**to guarantee good performance is 1.76 $\mu$ H at  $I_{LIM}$  (typ) dc current over the ambient temperature range.** Shielded inductors radiate less noise and should be preferred.

There are two methods to choose the inductor saturation current rating.

#### Method 1:

The saturation current is greater than the sum of the maximum load current and the worst case average to peak inductor current. This can be written as:

## Application Information (Continued)

$$I_{SAT} > I_{OUTMAX} + I_{RIPPLE}$$

$$\text{where } I_{RIPPLE} = \left( \frac{V_{IN} - V_{OUT}}{2 \times L} \right) \left( \frac{V_{OUT}}{V_{IN}} \right) \left( \frac{1}{f} \right)$$

- $I_{Ripple}$ : average to peak inductor current
- $I_{outmax}$ : maximum load current (600mA)
- $V_{IN}$ : maximum input voltage in application
- L: min inductor value including worst case tolerances (30% drop can be considered for method 1)
- f: minimum switching frequency (1.6 MHz)
- $V_{OUT}$ : output voltage

### Method 2:

A more conservative and recommended approach is to choose an inductor that has saturation current rating greater than the max current limit of 1200 mA.

A 2.2  $\mu$ H inductor with a saturation current rating of at least 1200 mA is recommended for most applications. The inductor's resistance should be less than around 0.3 $\Omega$  for good efficiency. *Table 2* lists suggested inductors and suppliers. For low-cost applications, an unshielded bobbin inductor is suggested. For noise critical applications, a toroidal or shielded-bobbin inductor should be used. A good practice is to lay out the board with overlapping footprints of both types

for design flexibility. This allows substitution of a low-noise toroidal inductor, in the event that noise from low-cost bobbin models is unacceptable.

### INPUT CAPACITOR SELECTION

A ceramic input capacitor of 4.7  $\mu$ F, 6.3V is sufficient for most applications. Place the input capacitor as close as possible to the  $V_{IN}$  pin of the device. A larger value may be used for improved input voltage filtering. Use X7R or X5R types; do not use Y5V. DC bias characteristics of ceramic capacitors must be considered when selecting case sizes like 0805 and 0603. **The minimum input capacitance to guarantee good performance is 2.2 $\mu$ F at 3V dc bias; 1.5 $\mu$ F at 5V dc bias including tolerances and over ambient temperature range.** The input filter capacitor supplies current to the PFET switch of the LM3674 in the first half of each cycle and reduces voltage ripple imposed on the input power source. A ceramic capacitor's low ESR provides the best noise filtering of the input voltage spikes due to this rapidly changing current. Select a capacitor with sufficient ripple current rating. The input current ripple can be calculated as:

$$I_{RMS} = I_{OUTMAX} \times \sqrt{\frac{V_{OUT}}{V_{IN}} \times \left( 1 - \frac{V_{OUT}}{V_{IN}} + \frac{r^2}{12} \right)}$$

$$r = \frac{(V_{IN} - V_{OUT}) \times V_{OUT}}{L \times f \times I_{OUTMAX} \times V_{IN}} \quad \text{The worst case is when } V_{IN} = 2 \times V_{OUT}$$

TABLE 2. Suggested Inductors and Their Suppliers

Model	Vendor	Dimensions LxWxH(mm)	D.C.R (max)
DO3314-222MX	Coilcraft	3.3 x 3.3 x 1.4	200 m $\Omega$
LPO3310-222MX	Coilcraft	3.3 x 3.3 x 1.0	150 m $\Omega$
ELL5GM2R2N	Panasonic	5.2 x 5.2 x 1.5	53 m $\Omega$
CDRH2D14-2R2	Sumida	3.2 x 3.2 x 1.55	94 m $\Omega$

## Application Information (Continued)

### OUTPUT CAPACITOR SELECTION

A ceramic output capacitor of 10  $\mu\text{F}$ , 6.3V is sufficient for most applications. Use X7R or X5R types; do not use Y5V. DC bias characteristics of ceramic capacitors must be considered when selecting case sizes like 0805 and 0603. DC bias characteristics vary from manufacturer to manufacturer and dc bias curves should be requested from them as part of the capacitor selection process.

**The minimum output capacitance to guarantee good performance is 5.75 $\mu\text{F}$  at 1.8V dc bias including tolerances and over ambient temperature range.** The output filter capacitor smoothes out current flow from the inductor to the load, helps maintain a steady output voltage during transient load changes and reduces output voltage ripple. These capacitors must be selected with sufficient capacitance and sufficiently low ESR to perform these functions.

The output voltage ripple is caused by the charging and discharging of the output capacitor and by the  $R_{\text{ESR}}$  and can be calculated as:

Voltage peak-to-peak ripple due to capacitance can be expressed as follow:

$$V_{\text{PP-C}} = \frac{I_{\text{ripple}}}{f \times 4 \times C}$$

Voltage peak-to-peak ripple due to ESR =

$$V_{\text{OUT}} = V_{\text{PP-ESR}} = I_{\text{PP}} * R_{\text{ESR}}$$

Because these two components are out of phase the rms value can be used to get an approximate value of peak-to-peak ripple.

Voltage peak-to-peak ripple, root mean squared =

$$V_{\text{PP-RMS}} = \sqrt{V_{\text{PP-C}}^2 + V_{\text{PP-ESR}}^2}$$

Note that the output ripple is dependent on the current ripple and the equivalent series resistance of the output capacitor ( $R_{\text{ESR}}$ ).

The  $R_{\text{ESR}}$  is frequency dependent (as well as temperature dependent); make sure the value used for calculations is at the switching frequency of the part.

**TABLE 3. Suggested Capacitors and Their Suppliers**

Model	Type	Vendor	Voltage Rating	Case size inch (mm)
<b>10 <math>\mu\text{F}</math> for <math>C_{\text{OUT}}</math></b>				
GRM21BR60J106K	Ceramic, X5R	Murata	6.3V	0805 (2012)
C2012X5R0J106K	Ceramic, X5R	TDK	6.3V	0805 (2012)
JMK212BJ106K	Ceramic, X5R	Taiyo-Yuden	6.3V	0805 (2012)
<b>4.7 <math>\mu\text{F}</math> for <math>C_{\text{IN}}</math></b>				
GRM21BR60J475K	Ceramic, X5R	Murata	6.3V	0805 (2012)
JMK212BJ475K	Ceramic, X5R	Taiyo-Yuden	6.3V	0805 (2012)
C2012X5R0J475K	Ceramic, X5R	TDK	6.3V	0805 (2012)

### BOARD LAYOUT CONSIDERATIONS

PC board layout is an important part of DC-DC converter design. Poor board layout can disrupt the performance of a DC-DC converter and surrounding circuitry by contributing to

EMI, ground bounce, and resistive voltage loss in the traces. These can send erroneous signals to the DC-DC converter IC, resulting in poor regulation or instability.

## Application Information (Continued)

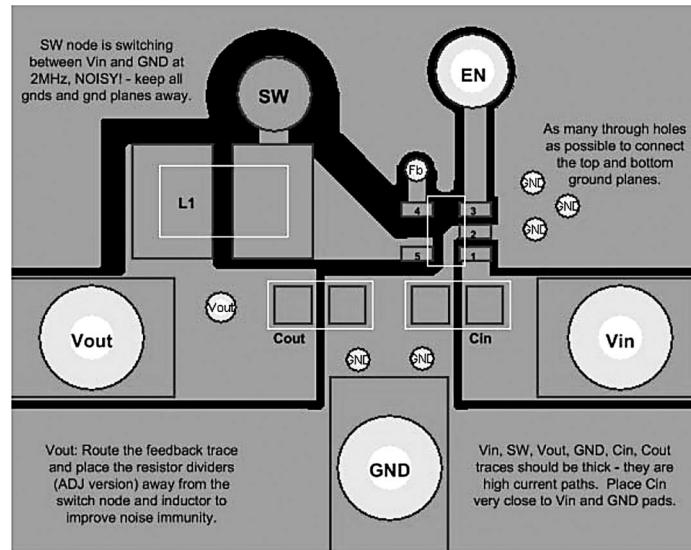

20167231

**FIGURE 5. Board Layout Design Rules for the LM3674**

Good layout for the LM3674 can be implemented by following a few simple design rules, as illustrated in .

1. *Place the LM3674, inductor and filter capacitors close together and make the traces short.* The traces between these components carry relatively high switching currents and act as antennas. Following this rule reduces radiated noise. Special care must be given to place the input filter capacitor very close to the  $V_{IN}$  and GND pin.
2. *Arrange the components so that the switching current loops curl in the same direction.* During the first half of each cycle, current flows from the input filter capacitor, through the LM3674 and inductor to the output filter capacitor and back through ground, forming a current loop. In the second half of each cycle, current is pulled up from ground, through the LM3674 by the inductor, to the output filter capacitor and then back through ground, forming a second current loop. Routing these loops so the current curls in the same direction prevents magnetic field reversal between the two half-cycles and reduces radiated noise.
3. *Connect the ground pins of the LM3674, and filter capacitors together using generous component-side copper fill as a pseudo-ground plane. Then, connect this to the ground-plane (if one is used) with several vias.* This reduces ground-plane noise by preventing the switching currents from circulating through the ground plane. It also reduces ground bounce at the LM3674 by giving it a low-impedance ground connection.
4. *Use wide traces between the power components and for power connections to the DC-DC converter circuit.* This

reduces voltage errors caused by resistive losses across the traces.

5. *Route noise sensitive traces, such as the voltage feedback path, away from noisy traces between the power components.* The voltage feedback trace must remain close to the LM3674 circuit and should be direct but should be routed opposite to noisy components. This reduces EMI radiated onto the DC-DC converter's own voltage feedback trace. A good approach is to route the feedback trace on another layer and to have a ground plane between the top layer and layer on which the feedback trace is routed. In the same manner for the adjustable part it is desired to have the feedback dividers on the bottom layer.
6. *Place noise sensitive circuitry, such as radio IF blocks, away from the DC-DC converter, CMOS digital blocks and other noisy circuitry.* Interference with noise-sensitive circuitry in the system can be reduced through distance.

In mobile phones, for example, a common practice is to place the DC-DC converter on one corner of the board, arrange the CMOS digital circuitry around it (since this also generates noise), and then place sensitive preamplifiers and IF stages on the diagonally opposing corner. Often, the sensitive circuitry is shielded with a metal pan and power to it is post-regulated to reduce conducted noise, using low-dropout linear regulators.

**Physical Dimensions** inches (millimeters) unless otherwise noted

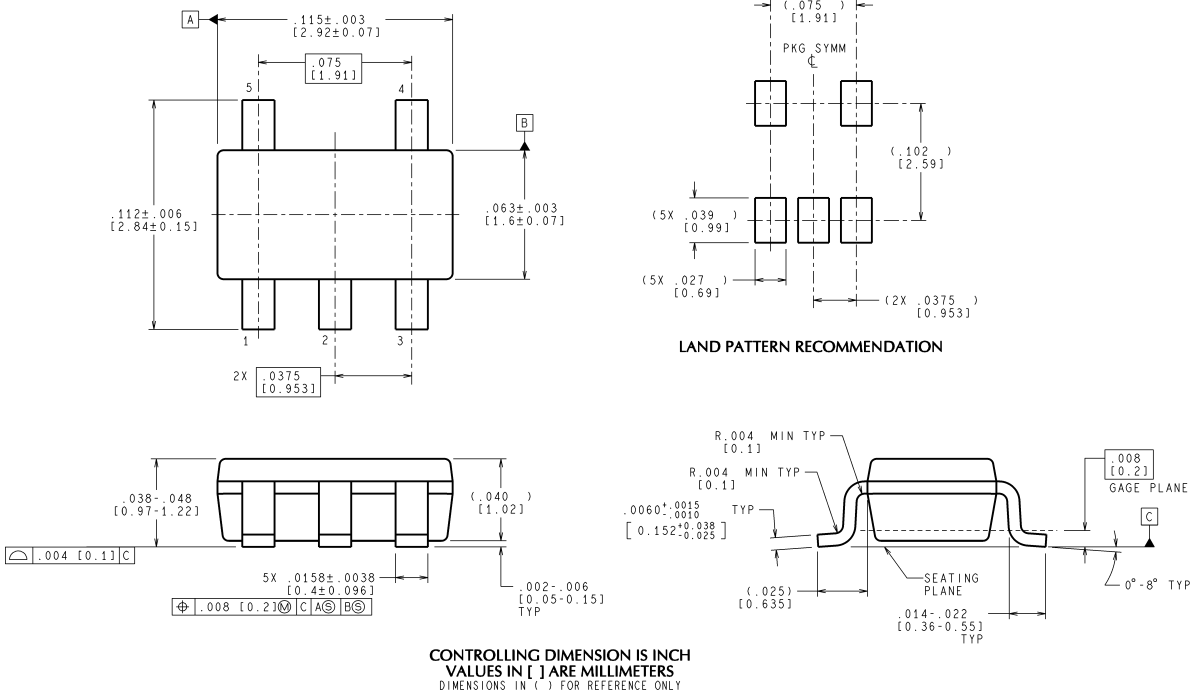

**5-Lead SOT23-5 Package  
NS Package Number MF05A**

National does not assume any responsibility for use of any circuitry described, no circuit patent licenses are implied and National reserves the right at any time without notice to change said circuitry and specifications.  
For the most current product information visit us at [www.national.com](http://www.national.com).

**LIFE SUPPORT POLICY**

NATIONAL'S PRODUCTS ARE NOT AUTHORIZED FOR USE AS CRITICAL COMPONENTS IN LIFE SUPPORT DEVICES OR SYSTEMS WITHOUT THE EXPRESS WRITTEN APPROVAL OF THE PRESIDENT AND GENERAL COUNSEL OF NATIONAL SEMICONDUCTOR CORPORATION. As used herein:

1. Life support devices or systems are devices or systems which, (a) are intended for surgical implant into the body, or (b) support or sustain life, and whose failure to perform when properly used in accordance with instructions for use provided in the labeling, can be reasonably expected to result in a significant injury to the user.
2. A critical component is any component of a life support device or system whose failure to perform can be reasonably expected to cause the failure of the life support device or system, or to affect its safety or effectiveness.

**BANNED SUBSTANCE COMPLIANCE**

National Semiconductor manufactures products and uses packing materials that meet the provisions of the Customer Products Stewardship Specification (CSP-9-111C2) and the Banned Substances and Materials of Interest Specification (CSP-9-111S2) and contain no "Banned Substances" as defined in CSP-9-111S2.

Leadfree products are RoHS compliant.

**National Semiconductor**  
Americas Customer Support Center  
Email: [new.feedback@nsc.com](mailto:new.feedback@nsc.com)  
Tel: 1-800-272-9959

**National Semiconductor**  
Europe Customer Support Center  
Fax: +49 (0) 180-530 85 86  
Email: [europe.support@nsc.com](mailto:europe.support@nsc.com)  
Deutsch Tel: +49 (0) 69 9508 6208  
English Tel: +44 (0) 870 24 0 2171  
Français Tel: +33 (0) 1 41 91 8790

**National Semiconductor**  
Asia Pacific Customer Support Center  
Email: [ap.support@nsc.com](mailto:ap.support@nsc.com)

**National Semiconductor**  
Japan Customer Support Center  
Fax: 81-3-5639-7507  
Email: [jpn.feedback@nsc.com](mailto:jpn.feedback@nsc.com)  
Tel: 81-3-5639-7560