

# LM4040, LM4041

## Precision Micro-Power Shunt Voltage References

### Description

LM4040 and LM4041 are precision two-terminal shunt mode voltage references offered in factory programmed reverse breakdown voltages of 1.225 V, 2.500 V, 3.000 V, 3.300 V, 4.096 V, and 5.000 V.

ON Semiconductor's Charge Programmable floating gate technology ensures precise voltage settings offering five grades of initial accuracy; from 0.1% to 2%.

LM4040 and LM4041 operate over a shunt current range of 60  $\mu$ A to 15 mA with low dynamic impedance, and 100 ppm/ $^{\circ}$ C temperature coefficient ensuring stable reverse breakdown voltage accuracy over a wide range of operating conditions.

These shunt regulators do not require an external stabilizing capacitor but are stable with any capacitive load (up to 1  $\mu$ F).

Offered in space saving SOT-23 and SC-70 packages LM4040 and LM4041 are specified for operation over the full industrial temperature range of  $-40^{\circ}$ C to  $+85^{\circ}$ C.

### Features

- Reverse Breakdown Voltages:
  - ◆ 1.225 V
  - ◆ 2.500 V
  - ◆ 3.000 V
  - ◆ 3.300 V
  - ◆ 4.096 V
  - ◆ 5.000 V
- Accuracy Grades:
  - ◆ A:  $\pm 0.1\%$
  - ◆ B:  $\pm 0.2\%$
  - ◆ C:  $\pm 0.5\%$
  - ◆ D:  $\pm 1.0\%$
  - ◆ E:  $\pm 2.0\%$
- Operating Current: 60  $\mu$ A to 15 mA
- Low Output Noise: 35  $\mu$ V (10 Hz to 10 KHz)
- Small Package Size: SOT-23, SC-70
- These Devices are Pb-Free, Halogen Free/BFR Free and are RoHS Compliant

### Typical Applications

- Mobile Handheld Devices
- Industrial Process Control
- Instrumentation
- Laptop and Desktop PCs
- Automotive
- Energy Management



ON Semiconductor®

<http://onsemi.com>



SOT-23 3 Lead  
TB SUFFIX  
CASE 527AG



SC-70 5 Lead  
SD SUFFIX  
CASE 419AC

### MARKING DIAGRAMS

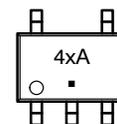
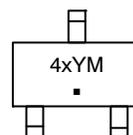

- 4x = Specific Device Code  
(4L = LM4040, 4M = LM4041)
- A = Assembly Location Code
- Y = Production Year
- M = Production Month
- = Pb-Free Package

### PIN CONNECTIONS

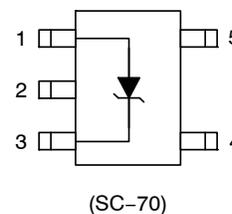
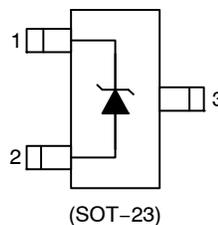

### ORDERING INFORMATION

See detailed ordering and shipping information in the package dimensions section on page 13 of this data sheet.

## LM4040, LM4041

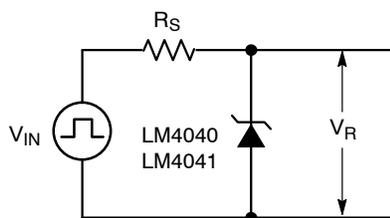

**Figure 1. Test Circuit**

**Table 1. PIN DESCRIPTIONS**

Pin		Name	Function
SOT-23	SC-70		
1	3	V+	Positive voltage
2	1	V-	Negative voltage
3	2	NC	This pin must be left floating or connected to V-.
	4	NIC	No Internal Connection. A voltage or signal applied to this pin will have no effect.
	5	NIC	

**Table 2. ABSOLUTE MAXIMUM RATINGS**

Parameter	Rating	Unit
Reverse Current	20	mA
Forward Current	10	mA
Junction Temperature	150	°C
Power Dissipation	SOT-23-3	300
Power Dissipation	SC-70-5	240
		mW

Stresses exceeding Maximum Ratings may damage the device. Maximum Ratings are stress ratings only. Functional operation above the Recommended Operating Conditions is not implied. Extended exposure to stresses above the Recommended Operating Conditions may affect device reliability.

**Table 3. RECOMMENDED OPERATING CONDITIONS**

Parameter	Rating	Unit
I <sub>REVERSE</sub>	0.06 – 15	mA
Ambient Temperature Range	-40 to +85	°C

**Table 4. ESD SUSCEPTABILITY**

Symbol	Parameter	Min	Units
ESD	Human Body Model	2000	V
	Machine Model	200	V

# LM4040, LM4041

**Table 5. DC ELECTRICAL CHARACTERISTICS**

 ( $I_R = 100 \mu\text{A}$ ,  $T_A = -40^\circ\text{C}$  to  $+85^\circ\text{C}$ , unless otherwise noted. Typical values are at  $T_A = +25^\circ\text{C}$ .)

Symbol	Parameter	Test Conditions	Limits			Units	
			Min	Typ	Max		
<b>1.225 V</b>							
$V_R$	Reverse Breakdown Voltage	$T_A = +25^\circ\text{C}$	LM4041A (0.1%)	1.2238	1.225	1.2262	V
			LM4041B (0.2%)	1.2226	1.225	1.2274	
			LM4041C (0.5%)	1.219	1.225	1.231	
			LM4041D (1.0%)	1.213	1.225	1.237	
			LM4041E (2.0%)	1.200	1.225	1.250	
$V_R$	Reverse Breakdown Voltage Tolerance	LM4041A		$\pm 1.2$	$\pm 9.2$	mV	
		LM4041B		$\pm 2.4$	$\pm 10.4$		
		LM4041C		$\pm 6$	$\pm 14$		
		LM4041D		$\pm 12$	$\pm 24$		
		LM4041E		$\pm 25$	$\pm 36$		
$I_{R\_MIN}$	Minimum Operating Current			45	65	$\mu\text{A}$	
$\Delta V_R/\Delta T$	Reverse Breakdown Voltage Temperature Coefficient	$I_R = 10 \text{ mA}$			$\pm 20$	ppm/ $^\circ\text{C}$	
		$I_R = 1 \text{ mA}$	LM4041A, B, C		$\pm 15$		$\pm 100$
			LM4041D, E		$\pm 15$		$\pm 150$
$I_R = 100 \mu\text{A}$			$\pm 15$				
$\Delta V_R/\Delta I_R$	Reverse Breakdown Voltage Change with Operating Current	$I_{R\_MIN} \leq I_R \leq 1 \text{ mA}$	LM4041A, B, C		0.7	2.0	mV
			LM4041D, E		0.7	2.5	
		$1 \text{ mA} \leq I_R \leq 15 \text{ mA}$	LM4041A, B, C		2.5	8	
			LM4041D, E		2.5	10	
$Z_R$	Reverse Dynamic Impedance	$I_R = 1 \text{ mA}$ , $f = 120 \text{ Hz}$ , $I_{AC} = 0.1 I_R$	LM4041A, B		0.5	1.5	$\Omega$
			LM4041C		0.5	1.5	
			LM4041D, E		0.5	2.0	
$e_N$	Wideband Noise	$I_R = 100 \mu\text{A}$ , $10 \text{ Hz} \leq f \leq 10 \text{ KHz}$			200	$\mu\text{V}_{RMS}$	
$\Delta V_R$	Reverse Breakdown Voltage Long Term Stability	$T = 1000 \text{ h}$			120	ppm	
$V_{HYST}$	Thermal Hysteresis (Note 2)	$\Delta T = -40^\circ\text{C}$ to $+125^\circ\text{C}$			0.08	%	

**2.500 V**

$V_R$	Reverse Breakdown Voltage	$T_A = +25^\circ\text{C}$	LM4040A (0.1%)	2.498	2.500	2.502	V
			LM4040B (0.2%)	2.496	2.500	2.504	
			LM4040C (0.5%)	2.490	2.500	2.510	
			LM4040D (1.0%)	2.475	2.500	2.525	
			LM4040E (2.0%)	2.450	2.500	2.550	
$V_R$	Reverse Breakdown Voltage Tolerance	LM4040A		$\pm 2$	$\pm 19$	mV	
		LM4040B		$\pm 4$	$\pm 21$		
		LM4040C		$\pm 10$	$\pm 29$		
		LM4040D		$\pm 25$	$\pm 49$		
		LM4040E		$\pm 50$	$\pm 74$		

1. Guaranteed by design.

 2. Thermal hysteresis is defined as the difference in voltage measured at  $+25^\circ\text{C}$  after cycling to temperature  $-40^\circ\text{C}$  and the  $25^\circ\text{C}$  measurement after cycling to temperature  $+125^\circ\text{C}$ .

# LM4040, LM4041

**Table 5. DC ELECTRICAL CHARACTERISTICS**

( $I_R = 100 \mu A$ ,  $T_A = -40^\circ C$  to  $+85^\circ C$ , unless otherwise noted. Typical values are at  $T_A = +25^\circ C$ .)

Symbol	Parameter	Test Conditions	Limits			Units	
			Min	Typ	Max		
<b>2.500 V</b>							
$I_{R\_MIN}$	Minimum Operating Current			45	65	$\mu A$	
$\Delta V_R/\Delta T$	Reverse Breakdown Voltage Temperature Coefficient	$I_R = 10 \text{ mA}$		$\pm 20$		ppm/ $^\circ C$	
		$I_R = 1 \text{ mA}$	LM4040A, B, C	$\pm 15$	$\pm 100$		
			LM4040D, E	$\pm 15$	$\pm 150$		
$I_R = 100 \mu A$		$\pm 15$					
$\Delta V_R/\Delta I_R$	Reverse Breakdown Voltage Change with Operating Current	$I_{R\_MIN} \leq I_R \leq 1 \text{ mA}$	LM4040A, B, C	0.3	1.0	mV	
			LM4040D, E	0.3	1.2		
		$1 \text{ mA} \leq I_R \leq 15 \text{ mA}$	LM4040A, B, C	2.5	8		
			LM4040D, E	2.5	10		
$Z_R$	Reverse Dynamic Impedance	$I_R = 1 \text{ mA}$ , $f = 120 \text{ Hz}$ , $I_{AC} = 0.1 I_R$	LM4040A, B	0.3	0.8	$\Omega$	
			LM4040C	0.3	0.9		
			LM4040D, E	0.3	1.1		
$e_N$	Wideband Noise	$I_R = 100 \mu A$ , $10 \text{ Hz} \leq f \leq 10 \text{ KHz}$		350		$\mu V_{RMS}$	
$\Delta V_R$	Reverse Breakdown Voltage Long Term Stability	$T = 1000 \text{ h}$		120		ppm	
$V_{HYST}$	Thermal Hysteresis (Note 2)	$\Delta T = -40^\circ C$ to $+125^\circ C$		0.08		%	
<b>3.000 V</b>							
$V_R$	Reverse Breakdown Voltage	$T_A = +25^\circ C$	LM4040A (0.1%)	2.997	3.000	3.003	V
			LM4040B (0.2%)	2.994	3.000	3.006	
			LM4040C (0.5%)	2.985	3.000	3.015	
			LM4040D (1.0%)	2.970	3.000	3.030	
			LM4040E (2.0%)	2.940	3.000	3.060	
$V_R$	Reverse Breakdown Voltage Tolerance	LM4040A		$\pm 3$	$\pm 22$	mV	
		LM4040B		$\pm 6$	$\pm 26$		
		LM4040C		$\pm 15$	$\pm 34$		
		LM4040D		$\pm 30$	$\pm 59$		
		LM4040E		$\pm 60$	$\pm 89$		
$I_{R\_MIN}$	Minimum Operating Current			45	65	$\mu A$	
$\Delta V_R/\Delta T$	Reverse Breakdown Voltage Temperature Coefficient	$I_R = 10 \text{ mA}$		$\pm 20$		ppm/ $^\circ C$	
		$I_R = 1 \text{ mA}$	LM4040A, B, C	$\pm 15$	$\pm 100$		
			LM4040D, E	$\pm 15$	$\pm 150$		
$I_R = 100 \mu A$		$\pm 15$					
$\Delta V_R/\Delta I_R$	Reverse Breakdown Voltage Change with Operating Current	$I_{R\_MIN} \leq I_R \leq 1 \text{ mA}$	LM4040A, B, C	0.4	1.1	mV	
			LM4040D, E	0.4	1.3		
		$1 \text{ mA} \leq I_R \leq 15 \text{ mA}$	LM4040A, B, C	2.7	9		
			LM4040D, E	2.7	11		

1. Guaranteed by design.

2. Thermal hysteresis is defined as the difference in voltage measured at  $+25^\circ C$  after cycling to temperature  $-40^\circ C$  and the  $25^\circ C$  measurement after cycling to temperature  $+125^\circ C$ .

# LM4040, LM4041

**Table 5. DC ELECTRICAL CHARACTERISTICS**

 ( $I_R = 100 \mu\text{A}$ ,  $T_A = -40^\circ\text{C}$  to  $+85^\circ\text{C}$ , unless otherwise noted. Typical values are at  $T_A = +25^\circ\text{C}$ .)

Symbol	Parameter	Test Conditions	Limits			Units	
			Min	Typ	Max		
<b>3.000 V</b>							
$Z_R$	Reverse Dynamic Impedance	$I_R = 1 \text{ mA}$ , $f = 120 \text{ Hz}$ , $I_{AC} = 0.1 I_R$	LM4040A, B		0.4	0.9	$\Omega$
			LM4040C		0.4	0.9	
			LM4040D, E		0.4	1.2	
$e_N$	Wideband Noise	$I_R = 100 \mu\text{A}$ , $10 \text{ Hz} \leq f \leq 10 \text{ KHz}$		350		$\mu\text{V}_{\text{RMS}}$	
$\Delta V_R$	Reverse Breakdown Voltage Long Term Stability	$T = 1000 \text{ h}$		120		ppm	
$V_{\text{HYST}}$	Thermal Hysteresis (Note 2)	$\Delta T = -40^\circ\text{C}$ to $+125^\circ\text{C}$		0.08		%	

**3.300 V**

$V_R$	Reverse Breakdown Voltage	$T_A = +25^\circ\text{C}$	LM4040A (0.1%)	3.297	3.300	3.303	V
			LM4040B (0.2%)	3.294	3.300	3.306	
$V_R$	Reverse Breakdown Voltage	$T_A = +25^\circ\text{C}$	LM4040C (0.5%)	3.285	3.300	3.315	V
			LM4040D (1.0%)	3.270	3.300	3.330	
$V_R$	Reverse Breakdown Voltage Tolerance	LM4040A			$\pm 3$	$\pm 22$	mV
		LM4040B			$\pm 6$	$\pm 26$	
		LM4040C			$\pm 15$	$\pm 34$	
		LM4040D			$\pm 30$	$\pm 59$	
$I_{R\_MIN}$	Minimum Operating Current			45	65	$\mu\text{A}$	
$\Delta V_R/\Delta T$	Reverse Breakdown Voltage Temperature Coefficient	$I_R = 10 \text{ mA}$			$\pm 20$		ppm/ $^\circ\text{C}$
		$I_R = 1 \text{ mA}$	LM4040A, B, C		$\pm 15$	$\pm 100$	
			LM4040D		$\pm 15$	$\pm 150$	
$I_R = 100 \mu\text{A}$			$\pm 15$				
$\Delta V_R/\Delta I_R$	Reverse Breakdown Voltage Change with Operating Current	$I_{R\_MIN} \leq I_R \leq 1 \text{ mA}$	LM4040A, B, C		0.3	1.0	mV
			LM4040D		0.3	1.2	
		$1 \text{ mA} \leq I_R \leq 15 \text{ mA}$	LM4040A, B, C		2.5	8	
			LM4040D		2.5	10	
$Z_R$	Reverse Dynamic Impedance	$I_R = 1 \text{ mA}$ , $f = 120 \text{ Hz}$ , $I_{AC} = 0.1 I_R$	LM4040A, B		0.3	0.8	$\Omega$
			LM4040C		0.3	0.9	
			LM4040D		0.3	1.1	
$e_N$	Wideband Noise	$I_R = 100 \mu\text{A}$ , $10 \text{ Hz} \leq f \leq 10 \text{ KHz}$		350		$\mu\text{V}_{\text{RMS}}$	
$\Delta V_R$	Reverse Breakdown Voltage Long Term Stability	$T = 1000 \text{ h}$		120		ppm	
$V_{\text{HYST}}$	Thermal Hysteresis (Note 2)	$\Delta T = -40^\circ\text{C}$ to $+125^\circ\text{C}$		0.08		%	

**4.096 V**

$V_R$	Reverse Breakdown Voltage	$T_A = +25^\circ\text{C}$	LM4040A (0.1%)	4.092	4.096	4.100	V
			LM4040B (0.2%)	4.088	4.096	4.104	
			LM4040C (0.5%)	4.080	4.096	4.120	
			LM4040D (1.0%)	4.055	4.096	4.137	

1. Guaranteed by design.

 2. Thermal hysteresis is defined as the difference in voltage measured at  $+25^\circ\text{C}$  after cycling to temperature  $-40^\circ\text{C}$  and the  $25^\circ\text{C}$  measurement after cycling to temperature  $+125^\circ\text{C}$ .

## LM4040, LM4041

**Table 5. DC ELECTRICAL CHARACTERISTICS**

( $I_R = 100 \mu\text{A}$ ,  $T_A = -40^\circ\text{C}$  to  $+85^\circ\text{C}$ , unless otherwise noted. Typical values are at  $T_A = +25^\circ\text{C}$ .)

Symbol	Parameter	Test Conditions	Limits			Units
			Min	Typ	Max	
<b>4.096 V</b>						
$V_R$	Reverse Breakdown Voltage Tolerance	LM4040A		$\pm 4$	$\pm 31$	mV
		LM4040B		$\pm 8$	$\pm 35$	
		LM4040C		$\pm 20$	$\pm 47$	
		LM4040D		$\pm 41$	$\pm 80$	
$I_{R\_MIN}$	Minimum Operating Current		45	65	$\mu\text{A}$	
$\Delta V_R/\Delta T$	Reverse Breakdown Voltage Temperature Coefficient	$I_R = 10 \text{ mA}$		$\pm 30$		ppm/ $^\circ\text{C}$
		$I_R = 1 \text{ mA}$	LM4040A, B, C	$\pm 20$	$\pm 100$	
			LM4040D	$\pm 20$	$\pm 150$	
$I_R = 100 \mu\text{A}$		$\pm 15$				
$\Delta V_R/\Delta I_R$	Reverse Breakdown Voltage Change with Operating Current	$I_{R\_MIN} \leq I_R \leq 1 \text{ mA}$	LM4040A, B, C	0.5	1.2	mV
			LM4040D	0.5	1.5	
		$1 \text{ mA} \leq I_R \leq 15 \text{ mA}$	LM4040A, B, C	3.0	10	
			LM4040D	3.0	13	
$Z_R$	Reverse Dynamic Impedance	$I_R = 1 \text{ mA}$ , $f = 120 \text{ Hz}$ , $I_{AC} = 0.1 I_R$	LM4040A, B	0.5	1.0	$\Omega$
			LM4040C	0.5	1.0	
			LM4040D	0.5	1.3	
$e_N$	Wideband Noise	$I_R = 100 \mu\text{A}$ , $10 \text{ Hz} \leq f \leq 10 \text{ KHz}$		800		$\mu\text{V}_{RMS}$
$\Delta V_R$	Reverse Breakdown Voltage Long Term Stability	$T = 1000 \text{ h}$		120		ppm
$V_{HYST}$	Thermal Hysteresis (Note 2)	$\Delta T = -40^\circ\text{C}$ to $+125^\circ\text{C}$		0.08		%

**5.000 V**

$V_R$	Reverse Breakdown Voltage	$T_A = +25^\circ\text{C}$	LM4040A (0.1%)	4.995	5.000	5.005	V
			LM4040B (0.2%)	4.990	5.000	5.010	
			LM4040C (0.5%)	4.975	5.000	5.025	
			LM4040D (1.0%)	4.950	5.000	5.050	
$V_R$	Reverse Breakdown Voltage Tolerance	LM4040A		$\pm 5$	$\pm 38$	mV	
		LM4040B		$\pm 10$	$\pm 43$		
		LM4040C		$\pm 25$	$\pm 58$		
		LM4040D		$\pm 50$	$\pm 99$		
$I_{R\_MIN}$	Minimum Operating Current		45	65	$\mu\text{A}$		
$\Delta V_R/\Delta T$	Reverse Breakdown Voltage Temperature Coefficient	$I_R = 10 \text{ mA}$		$\pm 30$		ppm/ $^\circ\text{C}$	
		$I_R = 1 \text{ mA}$	LM4040A, B, C	$\pm 20$	$\pm 100$		
			LM4040D	$\pm 20$	$\pm 150$		
$I_R = 100 \mu\text{A}$		$\pm 15$					

1. Guaranteed by design.

2. Thermal hysteresis is defined as the difference in voltage measured at  $+25^\circ\text{C}$  after cycling to temperature  $-40^\circ\text{C}$  and the  $25^\circ\text{C}$  measurement after cycling to temperature  $+125^\circ\text{C}$ .

# LM4040, LM4041

**Table 5. DC ELECTRICAL CHARACTERISTICS**

( $I_R = 100 \mu\text{A}$ ,  $T_A = -40^\circ\text{C}$  to  $+85^\circ\text{C}$ , unless otherwise noted. Typical values are at  $T_A = +25^\circ\text{C}$ .)

Symbol	Parameter	Test Conditions	Limits			Units	
			Min	Typ	Max		
<b>5.000 V</b>							
$\Delta V_R/\Delta I_R$	Reverse Breakdown Voltage Change with Operating Current	$I_{R\_MIN} \leq I_R \leq 1 \text{ mA}$	LM4040A, B, C		0.5	1.4	mV
			LM4040D		05	1.8	
		$1 \text{ mA} \leq I_R \leq 15 \text{ mA}$	LM4040A, B, C		3.5	12	
			LM4040D		3.5	15	
$Z_R$	Reverse Dynamic Impedance	$I_R = 1 \text{ mA}$ , $f = 120 \text{ Hz}$ , $I_{AC} = 0.1 I_R$	LM4040A, B		0.5	1.1	$\Omega$
			LM4040C		0.5	1.1	
			LM4040D		0.5	1.5	
$e_N$	Wideband Noise	$I_R = 100 \mu\text{A}$ , $10 \text{ Hz} \leq f \leq 10 \text{ KHz}$		800		$\mu\text{V}_{RMS}$	
$\Delta V_R$	Reverse Breakdown Voltage Long Term Stability	$T = 1000 \text{ h}$		120		ppm	
$V_{HYST}$	Thermal Hysteresis (Note 2)	$\Delta T = -40^\circ\text{C}$ to $+125^\circ\text{C}$		0.08		%	

1. Guaranteed by design.

2. Thermal hysteresis is defined as the difference in voltage measured at  $+25^\circ\text{C}$  after cycling to temperature  $-40^\circ\text{C}$  and the  $25^\circ\text{C}$  measurement after cycling to temperature  $+125^\circ\text{C}$ .

# LM4040, LM4041

## TYPICAL PERFORMANCE CHARACTERISTICS

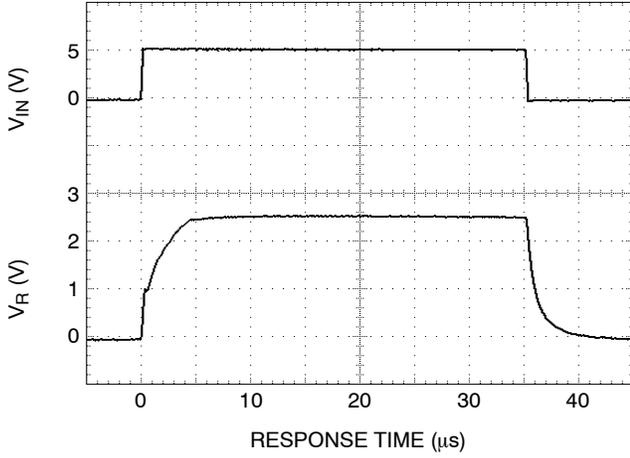

Figure 2. LM4040 – 2.5 V ( $R_S = 30\text{ k}$ )

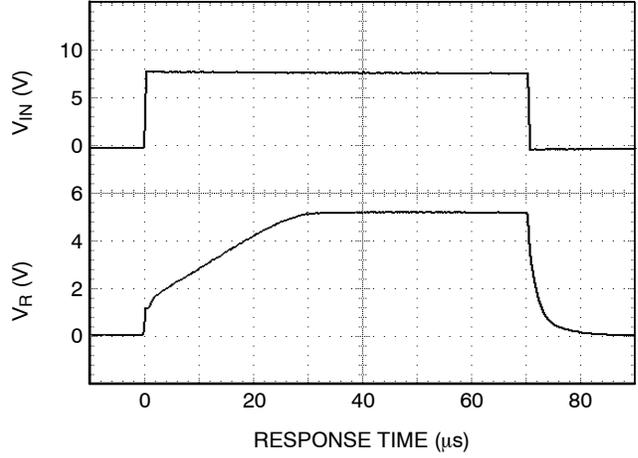

Figure 3. LM4040 – 5 V ( $R_S = 30\text{ k}$ )

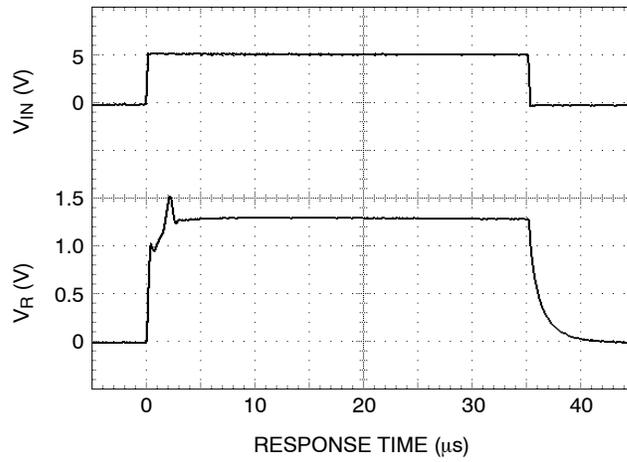

Figure 4. LM4041 – 1.225 V ( $R_S = 30\text{ k}$ )

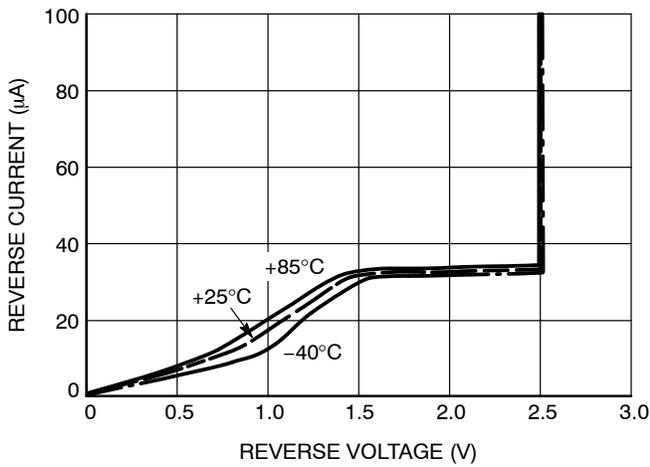

Figure 5. Reverse Characteristics  
(LM4040 – 2.5 V)

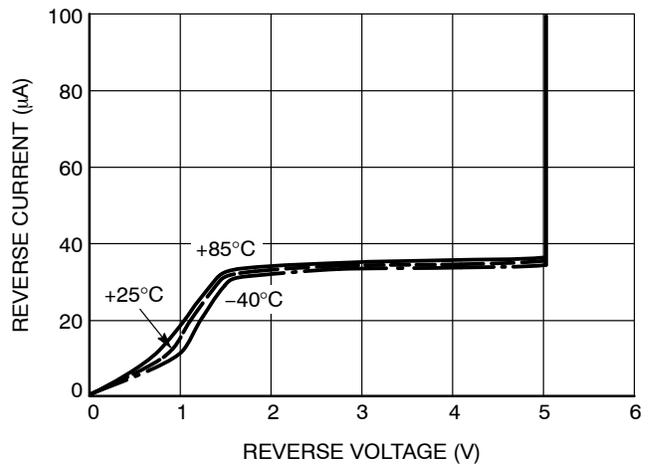

Figure 6. Reverse Characteristics  
(LM4040 – 5 V)

# LM4040, LM4041

## TYPICAL PERFORMANCE CHARACTERISTICS

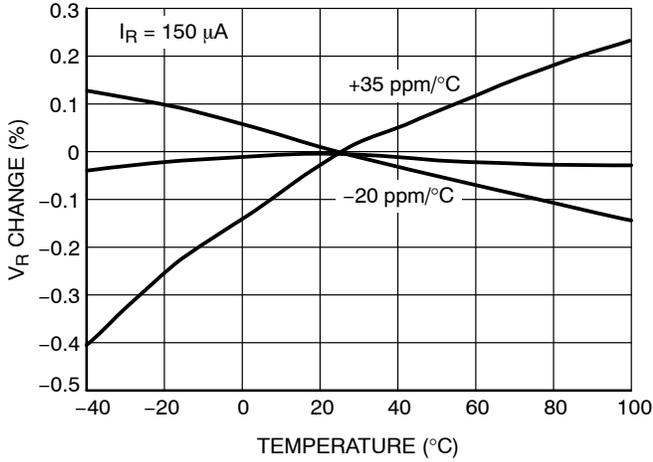

Figure 7. Temperature Drift - LM4040

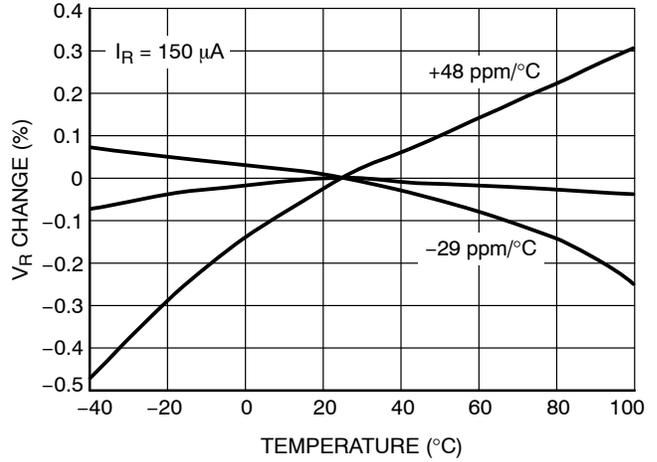

Figure 8. Temperature Drift - LM4041

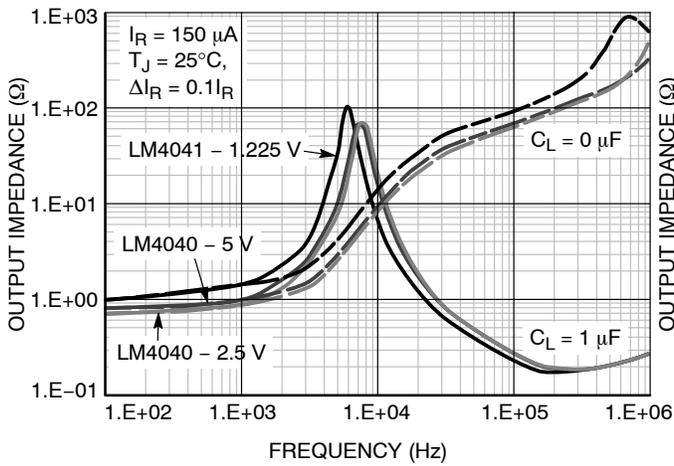

Figure 9. Output Impedance vs. Frequency

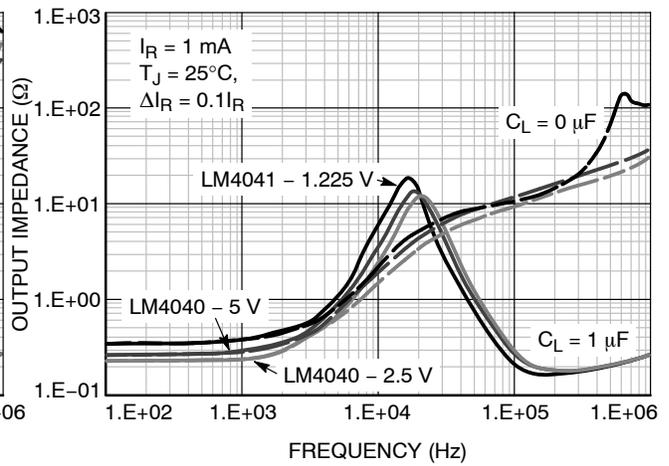

Figure 10. Output Impedance vs. Frequency

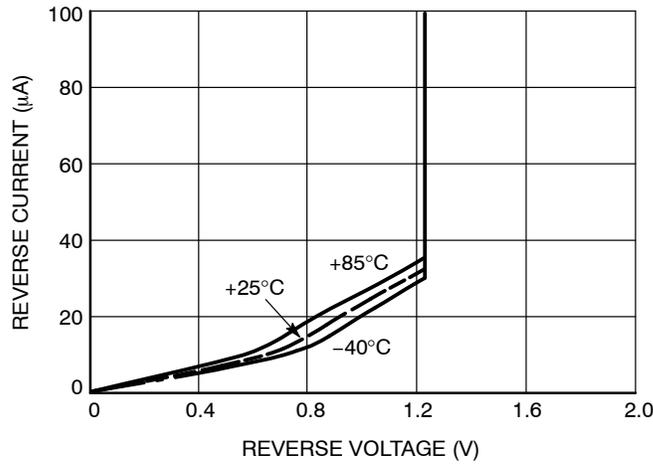

Figure 11. Reverse Characteristics - LM4041

## LM4040, LM4041

### Device Description

The LM404x shunt references use ON Semiconductor's floating gate (EEPROM) technology to produce a capacitor which stores an accurate and stable voltage that is used as the reference voltage for a control amplifier and shunt N-channel FET.

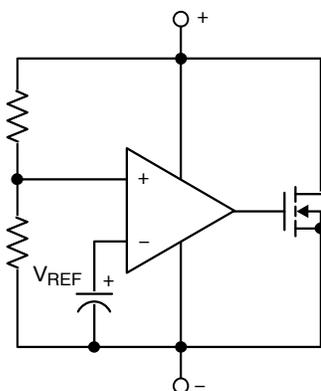

Figure 12. Functional Block Diagram

The device operates like a zener diode; maintaining a fixed voltage across its output terminals when biased with 60  $\mu\text{A}$  to 15 mA of reverse current. The LM404x will also act like a silicon diode when forward biased with currents up to 10 mA.

### Applications Information

The LM404x's internal pass transistor maintains a constant output voltage by sinking the necessary amount of current across a source resistor. The source resistance ( $R_S$ ) is set by the load current range ( $I_{LOAD}$ ), supply voltage ( $V_S$ ) variations, LM404x's terminal voltage ( $V_R$ ), and desired quiescent current.

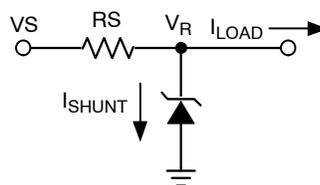

Figure 13. Typical Operating Circuit

To select a value of  $R_S$ , set  $V_S$  at its minimum value and  $I_{LOAD}$  at its maximum. Be sure to maintain a minimum operating current of 60  $\mu\text{A}$  through LM404x at all times, as LM404x uses this current to power its internal circuitry. The  $R_S$  value should be large enough to keep  $I_{SHUNT}$  less than 15 mA for proper regulation when  $V_S$  is maximum and  $I_{LOAD}$  is at a minimum. Therefore, the value of  $R_S$  is bounded by the following equation:

$$\frac{(V_{S(\min)} - V_R)}{(60 \mu\text{A} + I_{LOAD(\max)})} > R_S$$

and

$$R_S > \frac{(V_{S(\max)} - V_R)}{(15 \text{ mA} + I_{LOAD(\min)})}$$

Choosing a larger resistance minimizes the power dissipated in the circuit by reducing the shunt current.

### Output Capacitance

The LM404x does not require an external capacitor for frequency stability and is stable for any output capacitance.

### Effect of Temperature

LM404x has an output voltage temperature coefficient of typically  $\pm 15$  to  $\pm 30$  ppm/ $^{\circ}\text{C}$  meaning the LM404x's output voltage will change by 50 – 100  $\mu\text{V}/^{\circ}\text{C}$  for a 3.300 V regulator. The polarity of this temperature induced voltage shift can vary from device to device, some moving in the positive direction and others in the negative direction.

# LM4040, LM4041

## PACKAGE DIMENSIONS

SOT-23, 3 Lead  
CASE 527AG-01  
ISSUE O

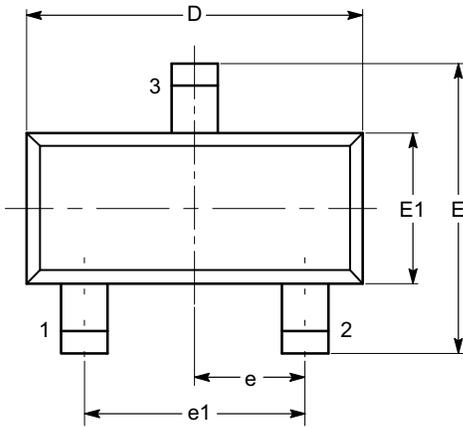

TOP VIEW

SYMBOL	MIN	NOM	MAX
A	0.89		1.12
A1	0.013		0.10
b	0.37		0.50
c	0.085		0.18
D	2.80		3.04
E	2.10		2.64
E1	1.20		1.40
e	0.95 BSC		
e1	1.90 BSC		
L	0.40 REF		
L1	0.54 REF		
$\theta$	0°		8°

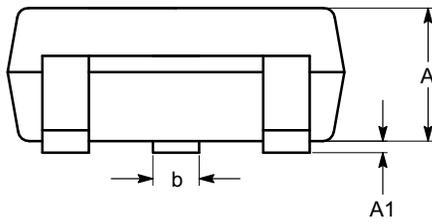

SIDE VIEW

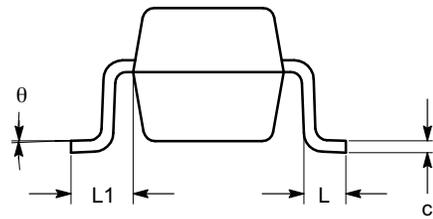

END VIEW

**Notes:**

- (1) All dimensions are in millimeters. Angles in degrees.
- (2) Complies with JEDEC TO-236.

# LM4040, LM4041

## PACKAGE DIMENSIONS

SC-88A (SC-70 5 Lead), 1.25x2  
CASE 419AC-01  
ISSUE A

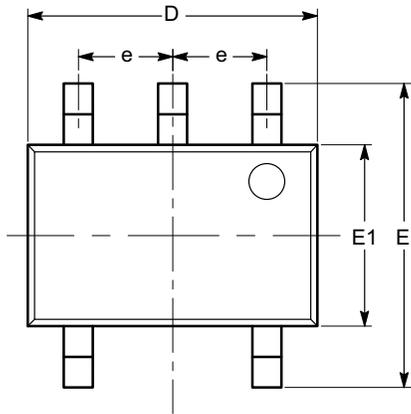

TOP VIEW

SYMBOL	MIN	NOM	MAX
A	0.80		1.10
A1	0.00		0.10
A2	0.80		1.00
b	0.15		0.30
c	0.10		0.18
D	1.80	2.00	2.20
E	1.80	2.10	2.40
E1	1.15	1.25	1.35
e	0.65 BSC		
L	0.26	0.36	0.46
L1	0.42 REF		
L2	0.15 BSC		
$\theta$	0°		8°
$\theta1$	4°		10°

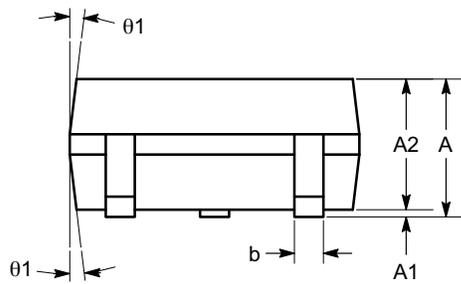

SIDE VIEW

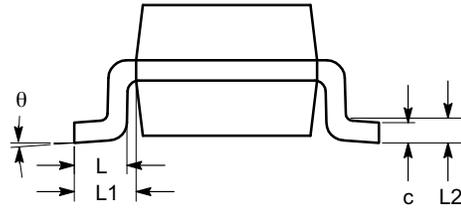

END VIEW

**Notes:**

- (1) All dimensions are in millimeters. Angles in degrees.
- (2) Complies with JEDEC MO-203.

# LM4040, LM4041

**Table 6. ORDERING INFORMATION**

Part Number	Specific Device Marking	Voltage	Accuracy	Max Drift	Temperature Range	Package (Note 3)	
LM4041ATB-122GT3	4M	1.225 V	±0.1%	100 ppm/°C	-40°C to 85°C	SOT-23-3	
LM4041BTB-122GT3			±0.2%				
LM4041CTB-122GT3			±0.5%				
LM4041DTB-122GT3			±1.0%,	150 ppm/°C			
LM4041ETB-122GT3			±2.0%,				
LM4040ATB-250GT3	4L	2.500 V	±0.1%	100 ppm/°C			
LM4040BTB-250GT3			±0.2%				
LM4040CTB-250GT3			±0.5%				
LM4040DTB-250GT3			±1.0%,	150 ppm/°C			
LM4040ETB-250GT3			±2.0%,				
LM4040ATB-300GT3		3.000 V	3.000 V	±0.1%			100 ppm/°C
LM4040BTB-300GT3				±0.2%			
LM4040CTB-300GT3				±0.5%			
LM4040DTB-300GT3				±1.0%,			150 ppm/°C
LM4040ETB-300GT3				±2.0%,			
LM4040ATB-330GT3		3.300 V	3.300 V	±0.1%	100 ppm/°C		
LM4040BTB-330GT3				±0.2%			
LM4040CTB-330GT3				±0.5%			
LM4040DTB-330GT3				±1.0%,	150 ppm/°C		
LM4040ETB-330GT3				±2.0%,			
LM4040ATB-409GT3	4.096 V	4.096 V	±0.1%	100 ppm/°C			
LM4040BTB-409GT3			±0.2%				
LM4040CTB-409GT3			±0.5%				
LM4040DTB-409GT3			±1.0%,	150 ppm/°C			
LM4040ETB-409GT3			±2.0%,				
LM4040ATB-500GT3	5.000 V	5.000 V	±0.1%	100 ppm/°C			
LM4040BTB-500GT3			±0.2%				
LM4040CTB-500GT3			±0.5%				
LM4040DTB-500GT3			±1.0%,	150 ppm/°C			
LM4040ETB-500GT3			±2.0%,				

3. Tape & Reel, 3,000 Units / Reel
4. All packages are RoHS-compliant (Lead-free, Halogen-free).
5. The standard lead finish is NiPdAu.
6. For information on tape and reel specifications, including part orientation and tape sizes, please refer to our Tape and Reel Packaging Specifications Brochure, BRD8011/D.
7. For detailed information and a breakdown of device nomenclature and numbering systems, please see the ON Semiconductor Device Nomenclature document, TND310/D, available at [www.onsemi.com](http://www.onsemi.com)

# LM4040, LM4041

**Table 6. ORDERING INFORMATION**

Part Number	Specific Device Marking	Voltage	Accuracy	Max Drift	Temperature Range	Package (Note 3)	
LM4041 <b>ASD</b> -122GT3	4M	1.225 V	±0.1%	100 ppm/°C	-40°C to 85°C	SC-70-5	
LM4041 <b>BSD</b> -122GT3			±0.2%				
LM4041 <b>CSD</b> -122GT3			±0.5%				
LM4041 <b>DSD</b> -122GT3			±1.0%,	150 ppm/°C			
LM4041 <b>ESD</b> -122GT3			±2.0%,				
LM4040 <b>ASD</b> -250GT3	4L	2.500 V	±0.1%	100 ppm/°C			
LM4040 <b>BSD</b> -250GT3			±0.2%				
LM4040 <b>CSD</b> -250GT3			±0.5%				
LM4040 <b>DSD</b> -250GT3			±1.0%,	150 ppm/°C			
LM4040 <b>ESD</b> -250GT3			±2.0%,				
LM4040 <b>ASD</b> -300GT3		3.000 V	3.000 V	±0.1%			100 ppm/°C
LM4040 <b>BSD</b> -300GT3				±0.2%			
LM4040 <b>CSD</b> -300GT3				±0.5%			
LM4040 <b>DSD</b> -300GT3				±1.0%,			150 ppm/°C
LM4040 <b>ESD</b> -300GT3				±2.0%,			
LM4040 <b>ASD</b> -330GT3		3.300 V	3.300 V	±0.1%	100 ppm/°C		
LM4040 <b>BSD</b> -330GT3				±0.2%			
LM4040 <b>CSD</b> -330GT3				±0.5%			
LM4040 <b>DSD</b> -330GT3				±1.0%,	150 ppm/°C		
LM4040 <b>ESD</b> -330GT3				±2.0%,			
LM4040 <b>ASD</b> -409GT3	4.096 V	4.096 V	±0.1%	100 ppm/°C			
LM4040 <b>BSD</b> -409GT3			±0.2%				
LM4040 <b>CSD</b> -409GT3			±0.5%				
LM4040 <b>DSD</b> -409GT3			±1.0%,	150 ppm/°C			
LM4040 <b>ESD</b> -409GT3			±2.0%,				
LM4040 <b>ASD</b> -500GT3	5.000 V	5.000 V	±0.1%	100 ppm/°C			
LM4040 <b>BSD</b> -500GT3			±0.2%				
LM4040 <b>CSD</b> -500GT3			±0.5%				
LM4040 <b>DSD</b> -500GT3			±1.0%,	150 ppm/°C			
LM4040 <b>ESD</b> -500GT3			±2.0%,				

3. Tape & Reel, 3,000 Units / Reel
4. All packages are RoHS-compliant (Lead-free, Halogen-free).
5. The standard lead finish is NiPdAu.
6. For information on tape and reel specifications, including part orientation and tape sizes, please refer to our Tape and Reel Packaging Specifications Brochure, BRD8011/D.
7. For detailed information and a breakdown of device nomenclature and numbering systems, please see the ON Semiconductor Device Nomenclature document, TND310/D, available at [www.onsemi.com](http://www.onsemi.com)

# LM4040, LM4041

**ON Semiconductor** and  are registered trademarks of Semiconductor Components Industries, LLC (SCILLC). SCILLC owns the rights to a number of patents, trademarks, copyrights, trade secrets, and other intellectual property. A listing of SCILLC's product/patent coverage may be accessed at [www.onsemi.com/site/pdf/Patent-Marking.pdf](http://www.onsemi.com/site/pdf/Patent-Marking.pdf). SCILLC reserves the right to make changes without further notice to any products herein. SCILLC makes no warranty, representation or guarantee regarding the suitability of its products for any particular purpose, nor does SCILLC assume any liability arising out of the application or use of any product or circuit, and specifically disclaims any and all liability, including without limitation special, consequential or incidental damages. "Typical" parameters which may be provided in SCILLC data sheets and/or specifications can and do vary in different applications and actual performance may vary over time. All operating parameters, including "Typicals" must be validated for each customer application by customer's technical experts. SCILLC does not convey any license under its patent rights nor the rights of others. SCILLC products are not designed, intended, or authorized for use as components in systems intended for surgical implant into the body, or other applications intended to support or sustain life, or for any other application in which the failure of the SCILLC product could create a situation where personal injury or death may occur. Should Buyer purchase or use SCILLC products for any such unintended or unauthorized application, Buyer shall indemnify and hold SCILLC and its officers, employees, subsidiaries, affiliates, and distributors harmless against all claims, costs, damages, and expenses, and reasonable attorney fees arising out of, directly or indirectly, any claim of personal injury or death associated with such unintended or unauthorized use, even if such claim alleges that SCILLC was negligent regarding the design or manufacture of the part. SCILLC is an Equal Opportunity/Affirmative Action Employer. This literature is subject to all applicable copyright laws and is not for resale in any manner.

## PUBLICATION ORDERING INFORMATION

### LITERATURE FULFILLMENT:

Literature Distribution Center for ON Semiconductor  
P.O. Box 5163, Denver, Colorado 80217 USA  
**Phone:** 303-675-2175 or 800-344-3860 Toll Free USA/Canada  
**Fax:** 303-675-2176 or 800-344-3867 Toll Free USA/Canada  
**Email:** [orderlit@onsemi.com](mailto:orderlit@onsemi.com)

**N. American Technical Support:** 800-282-9855 Toll Free  
USA/Canada  
**Europe, Middle East and Africa Technical Support:**  
Phone: 421 33 790 2910  
**Japan Customer Focus Center**  
Phone: 81-3-5817-1050

**ON Semiconductor Website:** [www.onsemi.com](http://www.onsemi.com)

**Order Literature:** <http://www.onsemi.com/orderlit>

For additional information, please contact your local Sales Representative