

## Precision micropower shunt voltage reference

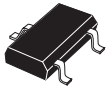

SOT23-3L

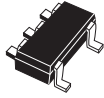

SOT323-5L

### Features

- Fixed 2.048 V, 2.5 V, 3.0 V, 4.096 V and 5.0 V output voltages
- Ultra low operating current: 10  $\mu$ A at 25 °C
- High precision @ 25 °C: +/- 0.1% (LM4040A), +/- 0.2% (LM4040B), +/- 0.5 % (LM4040C), +/- 1% (LM4040D)
- Very low LF noise: typ. 10  $\mu$  Vp-p
- Stable when used with capacitive loads
- Industrial (-40 to +125 °C) temperature range
- 70 ppm/°C max. temperature coefficient
- Available in SOT23-3L and SOT323-5L packages

#### Maturity status link

[LM4040](#)

### Applications

- Portable, battery-operated equipment
- Data acquisition systems
- Instrumentation

### Description

The LM4040 is a low power and high accuracy shunt voltage reference providing a stable output voltage over the industrial temperature range (-40 to +125 °C), with a maximum temperature coefficient of 70 ppm/°C. It is available in 0.1%, 0.2%, 0.5% and 1% initial accuracy versions. The SOT323-5L and SOT23-3L packages can be designed in applications where space saving is a critical issue. The very low operating current is a key advantage for power restricted designs. The LM4040 is very stable and can be used in a broad range of application conditions.

# 1 Pin configuration

Figure 1. Pin configuration SOT23-3L, SOT323-5L (top view)

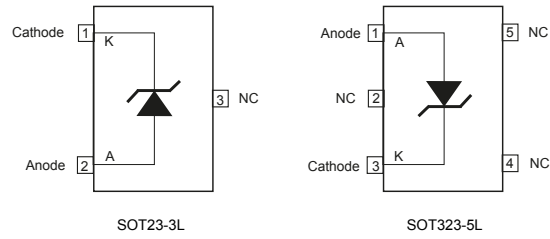

*Note:* The NC pin must be left unconnected or connected to anode.

## 2 Maximum ratings

**Table 1. Absolute maximum ratings**

Symbol	Parameter	Value	Unit
$I_k$	Reverse breakdown current	20	mA
$I_f$	Forward current	15	mA
$P_d$	Power dissipation <sup>(1)</sup>	500	mW
$T_{std}$	Storage temperature	-65 to +150	°C
ESD	Human Body Model (HBM)	2	kV
	Machine Model (MM)	200	V
	Charged device model	1500	V
$T_{lead}$	Lead temperature (soldering) 10 sec.	260	°C
$T_j$	Max. junction temperature	+150	°C

1.  $P_d$  has been calculated with  $T_{amb} = 25\text{ °C}$  and  $T_{jmax} = 150\text{ °C}$ .

**Note:** *Absolute maximum ratings are those values beyond which damage to the device may occur. Functional operation under these conditions is not implied.*

**Table 2. Thermal data**

Symbol	Parameter	SOT323-5L	SOT23-3L	Unit
$R_{thJA}$	Thermal resistance junction ambient	245	210	°C/W
$R_{thJC}$	Thermal resistance junction-case	105	103	°C/W

**Table 3. Operating conditions**

Symbol	Parameter	Value	Unit
$I_{kmin}$	Minimum operating current	10	μA
$I_{kmax}$	Maximum operating current	15	mA
$T_{oper}$	Operating free air temperature range	-40 to +125	°C

### 3 Electrical characteristics

**Table 4. Electrical characteristics. Limits are 100% production tested at 25 °C. Limits over full temperature range are guaranteed through correlation and by design.  $I_k = 10 \mu\text{A}$ ,  $T_{\text{amb}} = 25 \text{ °C}$  (unless otherwise specified).**

Symbol	Parameter	Test conditions	Min.	Typ.	Max.	Unit
$V_k$	Reverse breakdown voltage ( $V_k = 2.048 \text{ V}$ )	$I_k = 10 \mu\text{A}$ , LM4040A	2.0460	2.048	2.0500	V
		$I_k = 10 \mu\text{A}$ , LM4040B	2.0439		2.0521	
		$I_k = 10 \mu\text{A}$ , LM4040C	2.0378		2.0582	
		$I_k = 10 \mu\text{A}$ , LM4040D	2.0275		2.0685	
	Reverse breakdown voltage ( $V_k = 2.5 \text{ V}$ )	$I_k = 10 \mu\text{A}$ , LM4040A	2.4975	2.50	2.5025	V
		$I_k = 10 \mu\text{A}$ , LM4040B	2.4950		2.5050	
		$I_k = 10 \mu\text{A}$ , LM4040C	2.4875		2.5125	
		$I_k = 10 \mu\text{A}$ , LM4040D	2.4750		2.5250	
	Reverse breakdown voltage ( $V_k = 3.0 \text{ V}$ )	$I_k = 12 \mu\text{A}$ , LM4040A	2.9970	3.0	3.0030	V
		$I_k = 12 \mu\text{A}$ , LM4040B	2.9940		3.0060	
		$I_k = 12 \mu\text{A}$ , LM4040c	2.9850		3.0150	
		$I_k = 12 \mu\text{A}$ , LM4040D	2.9700		3.0300	
	Reverse breakdown voltage ( $V_k = 4.096 \text{ V}$ )	$I_k = 20 \mu\text{A}$ , LM4040A	4.0919	4.096	4.1001	V
		$I_k = 20 \mu\text{A}$ , LM4040B	4.0878		4.1042	
		$I_k = 20 \mu\text{A}$ , LM4040C	4.0755		4.1165	
		$I_k = 20 \mu\text{A}$ , LM4040D	4.0550		4.1370	
	Reverse breakdown voltage ( $V_k = 5.0 \text{ V}$ )	$I_k = 20 \mu\text{A}$ , LM4040A	4.9950	5.0	5.0050	V
		$I_k = 20 \mu\text{A}$ , LM4040B	4.9900		5.0100	
		$I_k = 20 \mu\text{A}$ , LM4040C	4.9750		5.0250	
		$I_k = 20 \mu\text{A}$ , LM4040D	4.9500		5.0500	
$I_{k\text{min}}$	Minimum operating current	$T_{\text{amb}} = 25 \text{ °C}$ , $V_k < 2.5 \text{ V}$		7.5	10	$\mu\text{A}$
		$-40 \text{ °C} < T_{\text{amb}} < +125 \text{ °C}$			12	
		$T_{\text{amb}} = 25 \text{ °C}$ , $V_k > 3.0 \text{ V}$		15	20	
		$-40 \text{ °C} < T_{\text{amb}} < +125 \text{ °C}$			25	
$\Delta V_k / \Delta T$	Average temperature coefficient	$10 \mu\text{A} < I_k < 20 \text{ mA}$		20	70	ppm/°C
$\Delta V_k / \Delta I_k$	Reverse breakdown voltage change with operating current range	$I_k \text{ min} < I_k < 1 \text{ mA}$ $-40 \text{ °C} < T_{\text{amb}} < +125 \text{ °C}$		0.2	1	mV
		$1 \text{ mA} < I_k < 15 \text{ mA}$ $-40 \text{ °C} < T_{\text{amb}} < +125 \text{ °C}$		1.7	4	
$R_{ka}$	Static impedance	$\Delta I_k = 10 \mu\text{A}$ to $10 \text{ mA}$		0.15	0.3	$\Omega$
Hys	Thermal hysteresis <sup>(1)</sup>	$I_k = 10 \mu\text{A}$		120		ppm
Noise	Wideband noise	$I_k = 10 \mu\text{A}$ , $10 \text{ Hz} < f < 10 \text{ kHz}$		95		$\mu\text{V}_{\text{RMS}}$
	Low frequency noise	$I_k = 10 \mu\text{A}$ , $0.1 \text{ Hz} < f < 10 \text{ Hz}$		10		$\mu\text{V}_{\text{p-p}}$

1. Thermal hysteresis is defined as the difference in voltage measured at +25 °C after cycling to -40 °C and the measurement at +25 °C after cycling to temperature +125 °C

## 4 Typical performance characteristics

( $C_{IN} = 1 \mu\text{F}$ ;  $C_{OUT} = 10 \mu\text{F}$ ,  $T_J = 25^\circ\text{C}$  unless otherwise specified.)

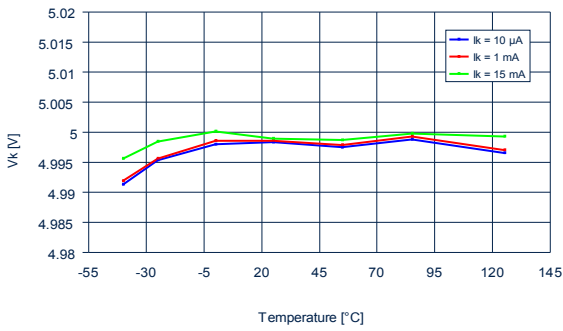
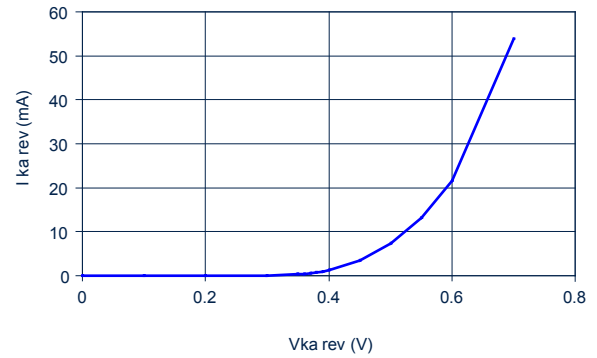
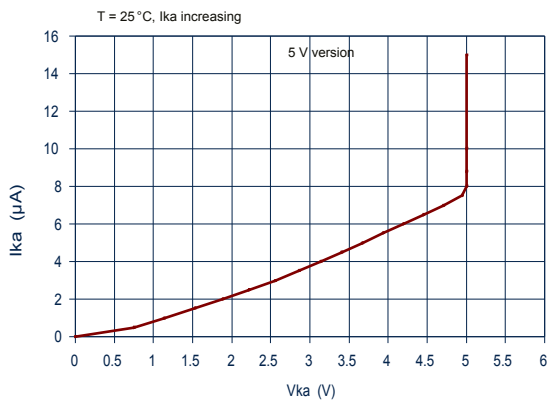
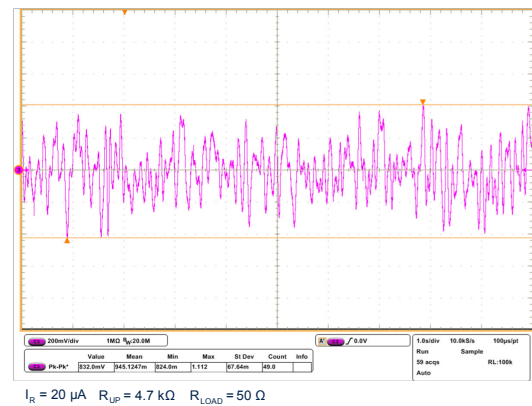
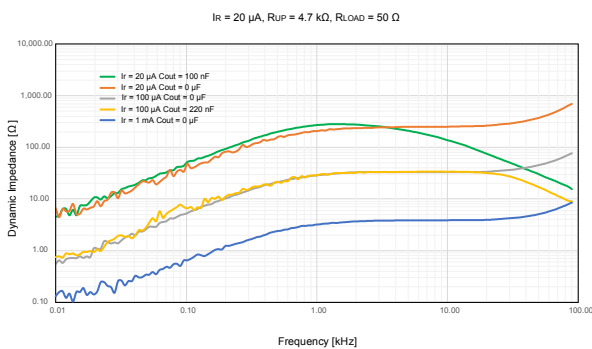
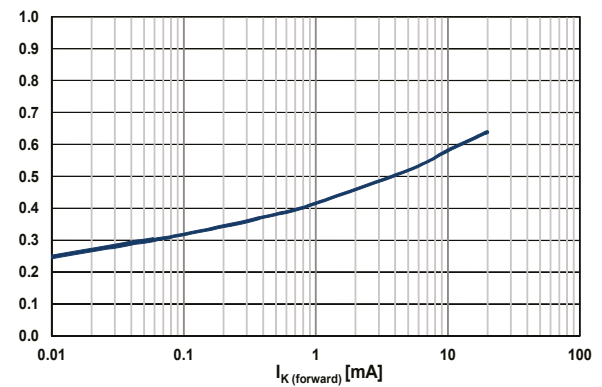
**Figure 2.  $V_K$  change vs. temperature (5 V version)**

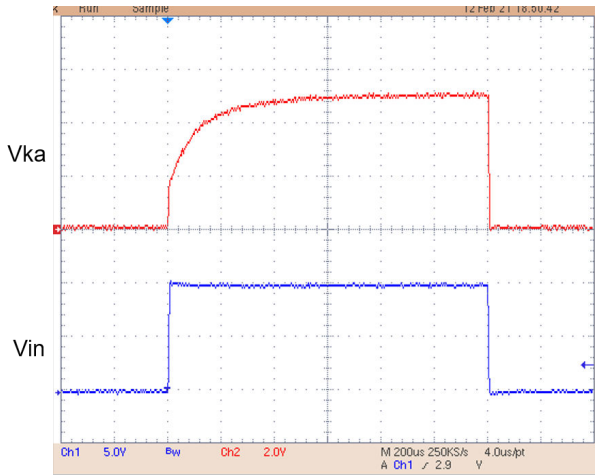
**Figure 3.  $V_K$  change vs. temperature (5 V version)**

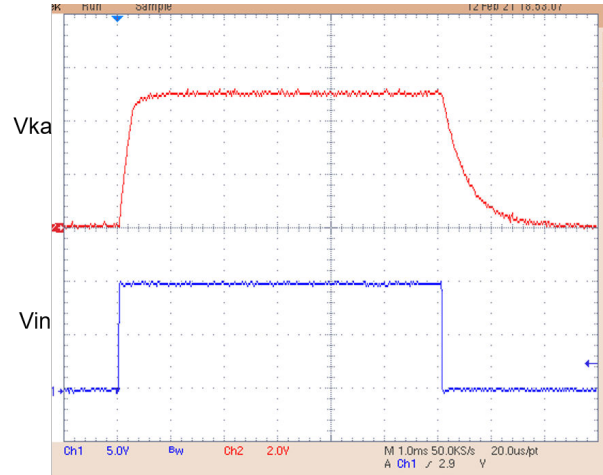
**Figure 4.  $I_{Kmin}$  minimum current for regulation**

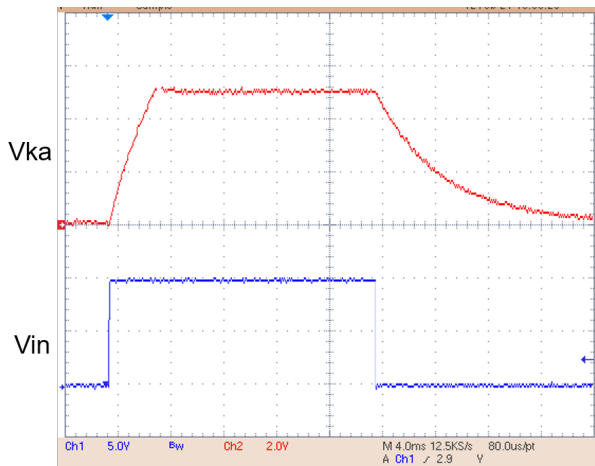
**Figure 5. Low frequency noise test**

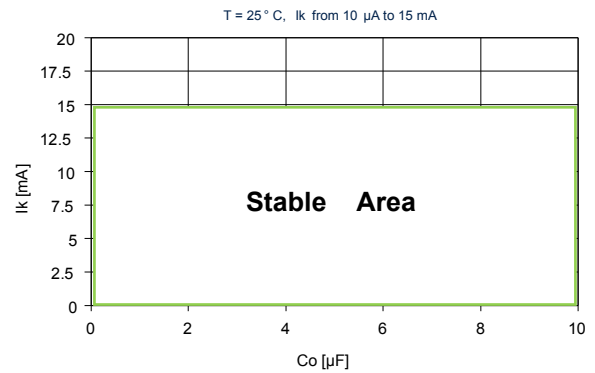
**Figure 6. Measured dynamic impedance**

**Figure 7. Forward characteristics**

**Figure 8. Turn-on time setting (no Load)**

 Vin: 10 V, trise: 5  $\mu$ sec, Ika: 10  $\mu$ A, No Load

**Figure 9. Turn-on time setting (Load = 100 nF)**

 Vin: 10 V, trise: 5  $\mu$ sec, Ika: 10  $\mu$ A, Load: 100 nF

**Figure 10. Turn-on time setting (Load = 1  $\mu$ F)**

 Vin: 10 V, trise: 5  $\mu$ sec, Ika: 10  $\mu$ A, Load: 1  $\mu$ F

**Figure 11. Stability plane vs. Cout**

## 5 Package information

In order to meet environmental requirements, ST offers these devices in different grades of **ECOPACK** packages, depending on their level of environmental compliance. ECOPACK specifications, grade definitions and product status are available at: [www.st.com](http://www.st.com). ECOPACK is an ST trademark.

### 5.1 SOT23-3L package information

Figure 12. SOT23-3L package outline

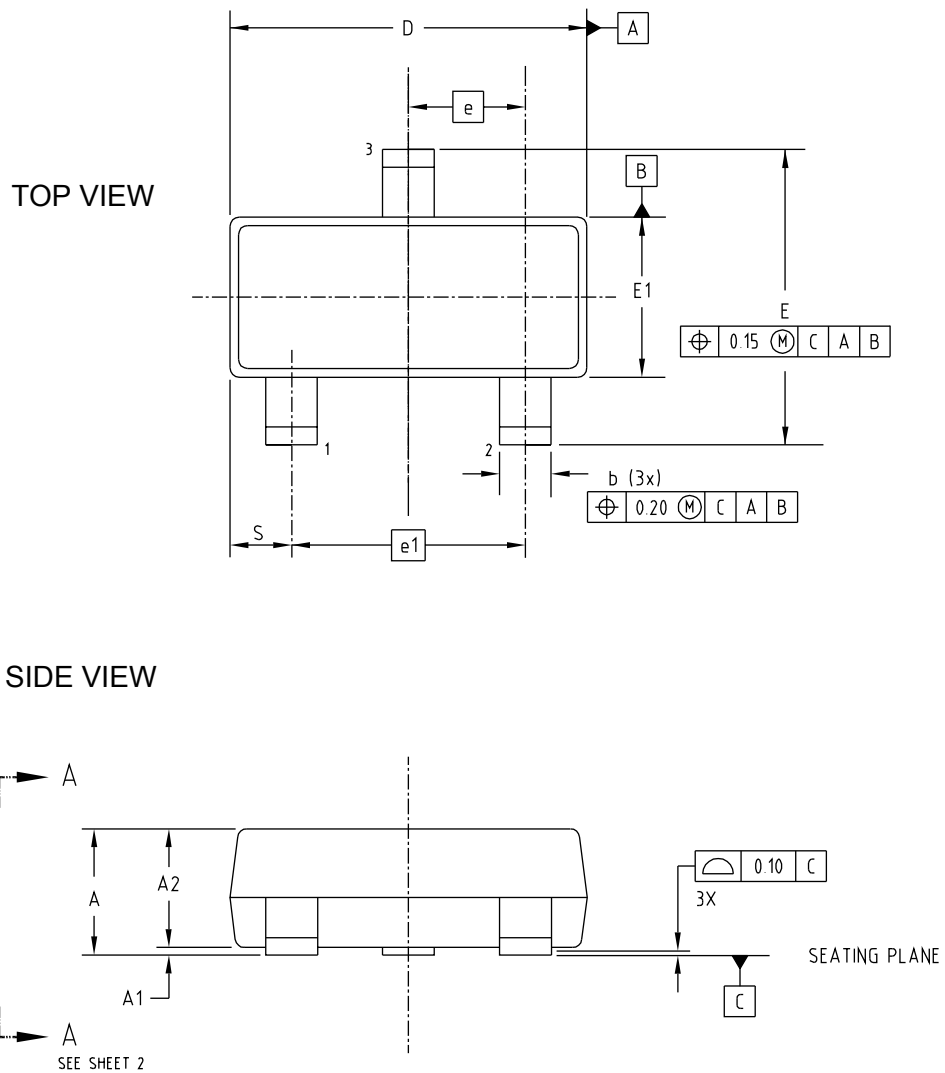

**Table 5. SOT23-3L mechanical data**

Dim.	mm		
	Min.	Typ.	Max.
A	0.89		1.12
A1	0.013		0.10
A2	0.88	0.95	1.2
b	0.37		0.50
b1	0.37	0.40	0.45
c	0.085		0.18
c1	0.085		0.16
D	2.80	2.90	3.04
E	2.10		2.64
E1	1.20	1.30	1.40
e		0.95 BSC	
e1		1.90 BSC	
L	0.28	0.38	0.48
L1	0.55 REF		
L2			
R	0.05		
R1	0.05		
θ	0°		8°
s	0.45		0.60

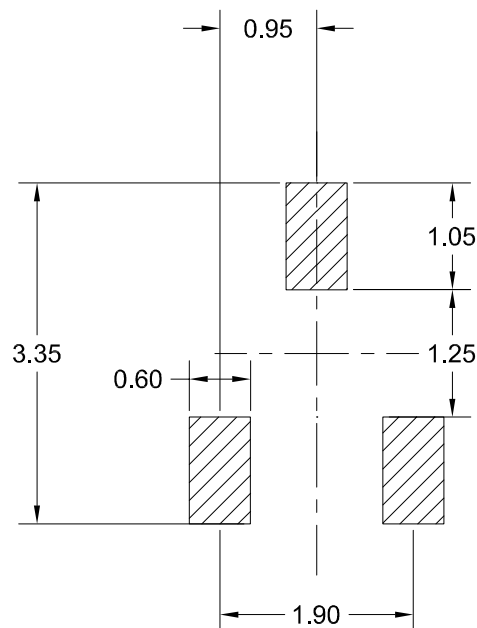
**Figure 13. SOT23-3L recommended footprint**



## 5.2 SOT323-5L package information

Figure 14. SOT323-5L package outline

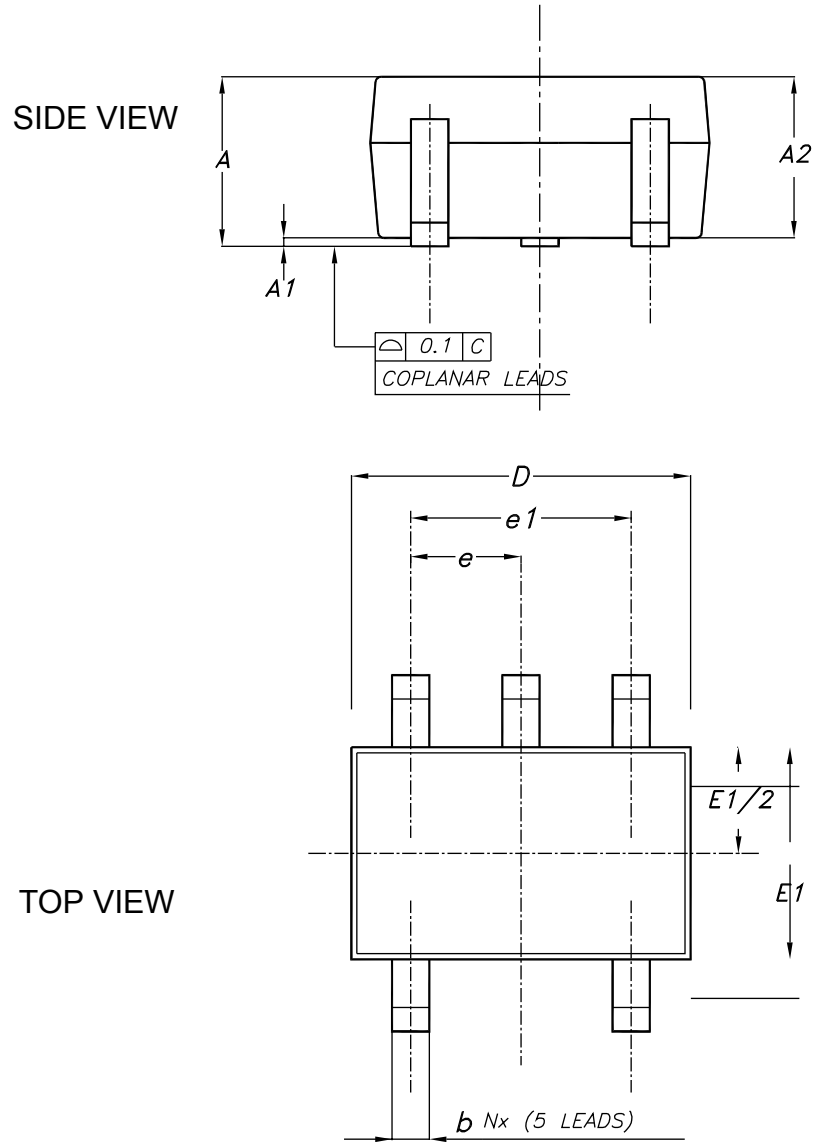

**Table 6. SOT323-5L mechanical data**

Dim.	mm		
	Min.	Typ.	Max.
A	0.80		1.10
A1	0		0.10
A2	0.80	0.90	1
b	0.15		0.30
c	0.10		0.22
D	1.80	2	2.20
E	1.80	2.10	2.40
E1	1.15	1.25	1.35
e		0.65	
e1		130	
L	0.26	0.36	0.46
<	0°		8°

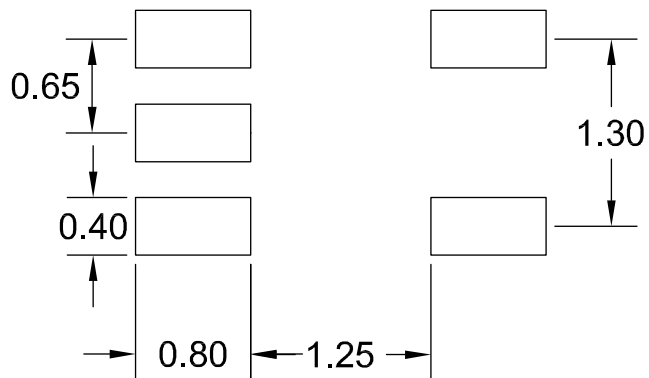
**Figure 15. SOT323-5L recommended footprint**

### 5.3 SOT23-3L packing information

Figure 16. SOT23-3L tape outline

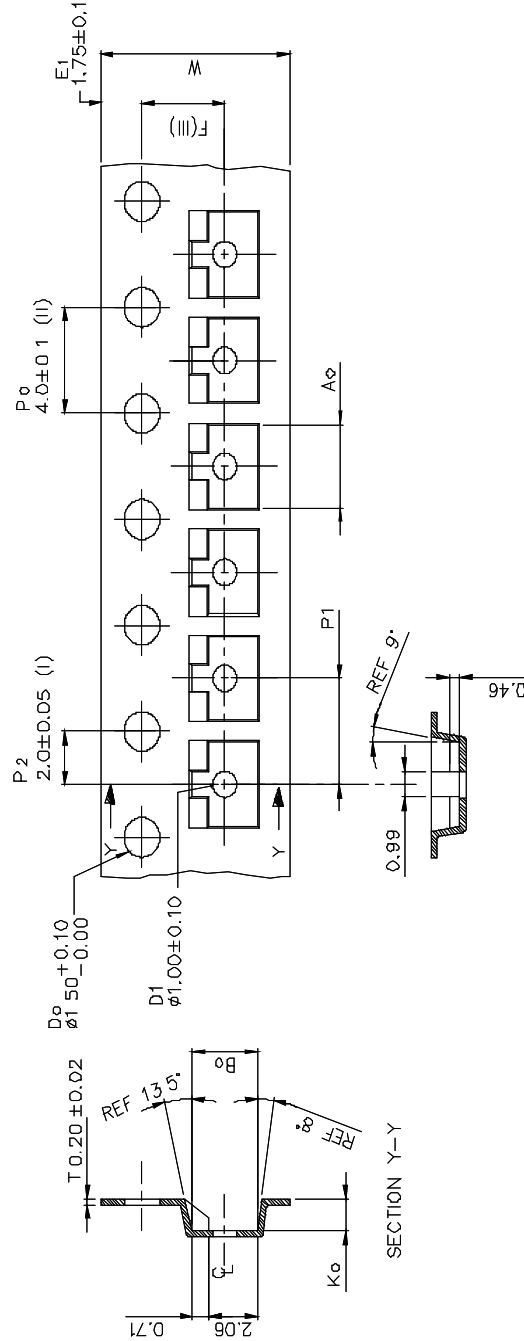

- (I) Measured from centreline of sprocket hole to centreline of pocket.
- (II) Cumulative tolerance of 10 sprocket holes is  $\pm 0.20$ .
- (III) Measured from centreline of sprocket hole to centreline of pocket.
- (IV) Other material available.
- (V) Typical SR of form tape Max. 10 $\mu$  OHM/SR

ALL DIMENSIONS IN MILLIMETRES UNLESS OTHERWISE STATED.

$A_0$	$3.15 \pm 0.10$
$B_0$	$2.77 \pm 0.10$
$K_0$	$1.22 \pm 0.10$
$F$	$3.50 \pm 0.05$
$P_1$	$4.00 \pm 0.10$
$W$	$8.00 \pm 0.3 / -0.1$

Figure 17. SOT23-3L reel drawing

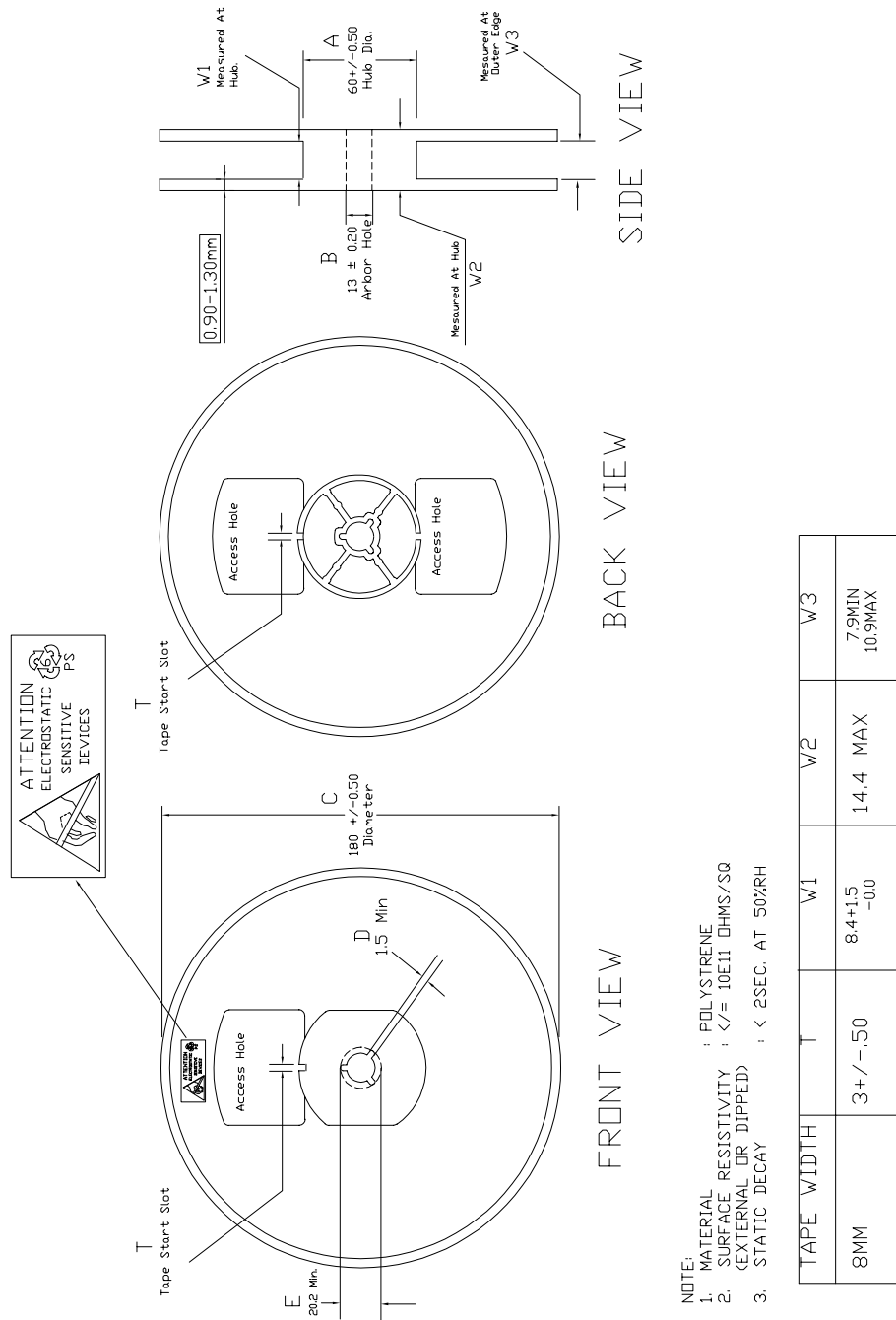
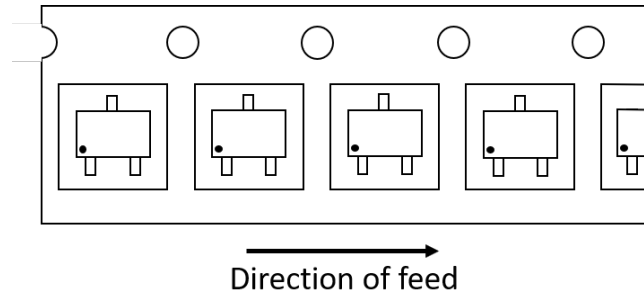

Figure 18. SOT23-3L tape direction



## 5.4 SOT323-5L packing information

Figure 19. SOT323-5L tape outline

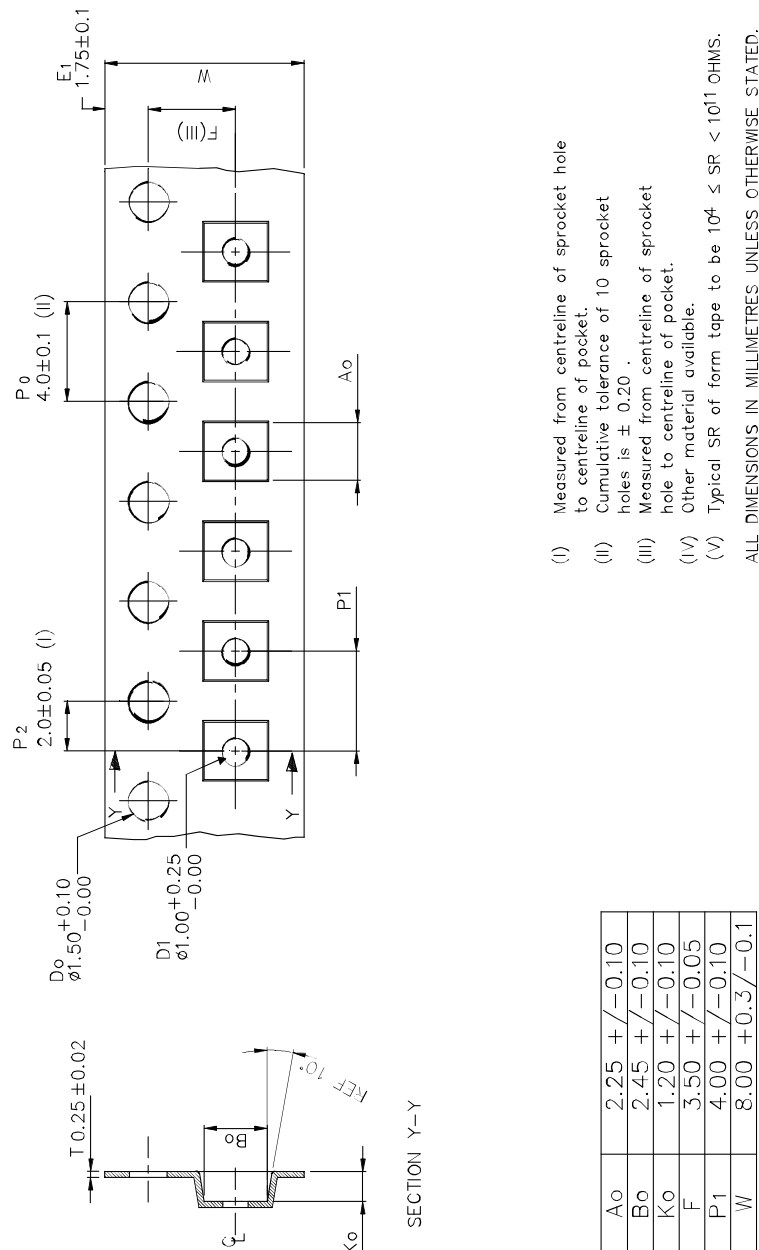

Figure 20. SOT323-5L reel drawing

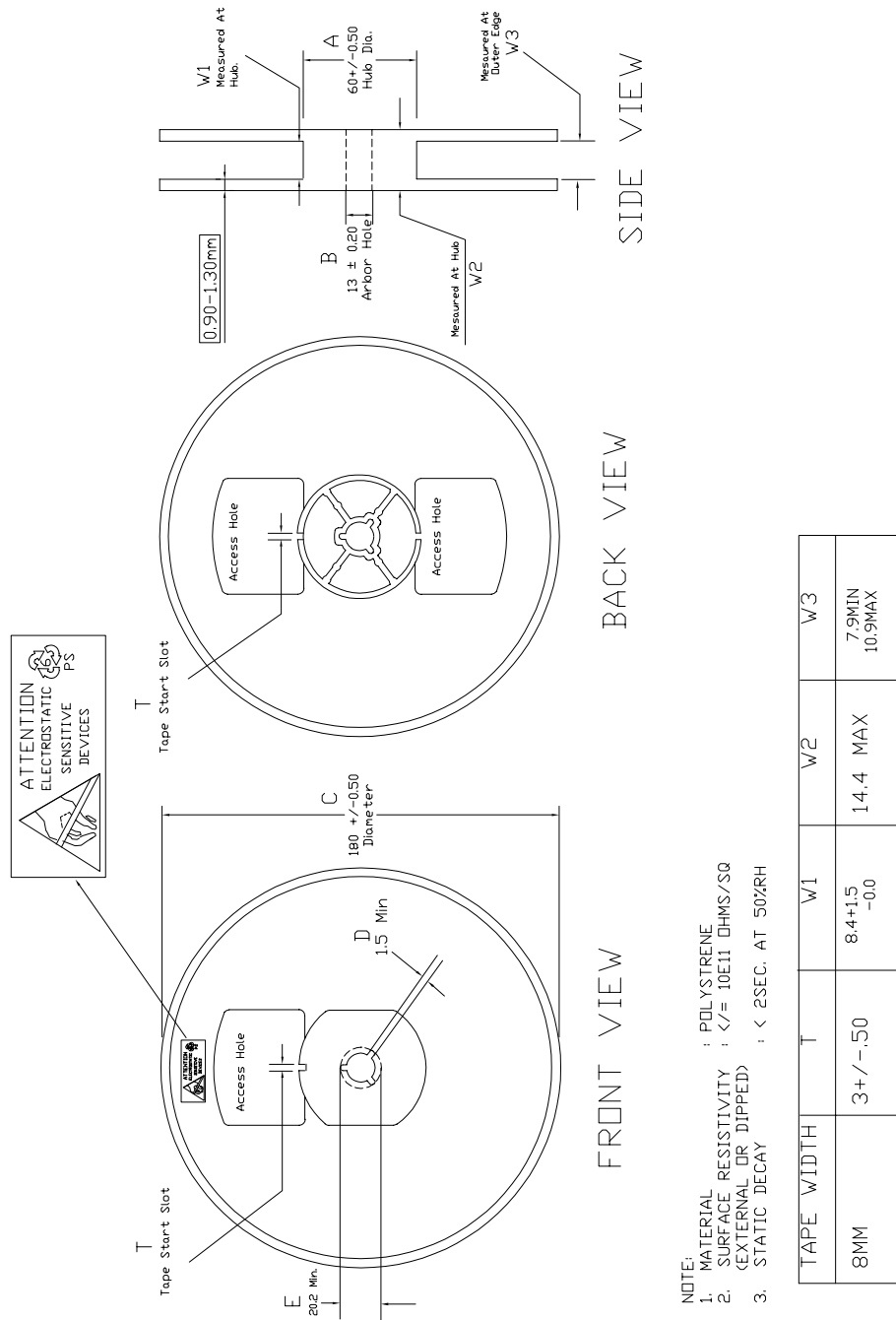
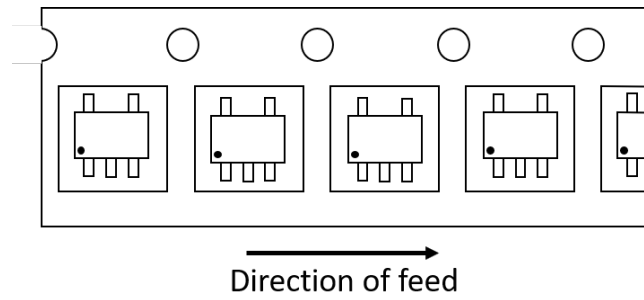

Figure 21. SOT323-5L tape direction



## 6 Ordering information

Order codes	Precision (%)	Package	Output voltage (V)	Marking	Temperature range (°C)
LM4040AELT-2.0	0.1%	SOT23-3L	2.048	A20	-40°C to +125°C
LM4040BELT-2.0	0.2%	SOT23-3L	2.048	B20	-40°C to +125°C
LM4040CELT-2.0	0.5%	SOT23-3L	2.048	C20	-40°C to +125°C
LM4040DELT-2.0	1.0%	SOT23-3L	2.048	D20	-40°C to +125°C
LM4040AECT-2.0	0.1%	SOT323-5L	2.048	A20	-40°C to +125°C
LM4040BECT-2.0	0.2%	SOT323-5L	2.048	A20	-40°C to +125°C
LM4040CECT-2.0	0.5%	SOT323-5L	2.048	C20	-40°C to +125°C
LM4040DECT-2.0	1.0%	SOT323-5L	2.048	D20	-40°C to +125°C
LM4040AELT-2.5	0.1%	SOT23-3L	2.5	A25	-40°C to +125°C
LM4040BELT-2.5	0.2%	SOT23-3L	2.5	B25	-40°C to +125°C
LM4040CELT-2.5	0.5%	SOT23-3L	2.5	C25	-40°C to +125°C
LM4040DELT-2.5	1.0%	SOT23-3L	2.5	D25	-40°C to +125°C
LM4040AECT-2.5	0.1%	SOT323-5L	2.5	A25	-40°C to +125°C
LM4040BECT-2.5	0.2%	SOT323-5L	2.5	A25	-40°C to +125°C
LM4040CECT-2.5	0.5%	SOT323-5L	2.5	C25	-40°C to +125°C
LM4040DECT-2.5	1.0%	SOT323-5L	2.5	D25	-40°C to +125°C
LM4040AELT-3.0	0.1%	SOT23-3L	3.0	A30	-40°C to +125°C
LM4040BELT-3.0	0.2%	SOT23-3L	3.0	B30	-40°C to +125°C
LM4040CELT-3.0	0.5%	SOT23-3L	3.0	C30	-40°C to +125°C
LM4040DELT-3.0	1.0%	SOT23-3L	3.0	D30	-40°C to +125°C
LM4040AECT-3.0	0.1%	SOT323-5L	3.0	A30	-40°C to +125°C
LM4040BECT-3.0	0.2%	SOT323-5L	3.0	A30	-40°C to +125°C
LM4040CECT-3.0	0.5%	SOT323-5L	3.0	C30	-40°C to +125°C
LM4040DECT-3.0	1.0%	SOT323-5L	3.0	D30	-40°C to +125°C
LM4040AELT-4.1	0.1%	SOT23-3L	4.096	A40	-40°C to +125°C
LM4040BELT-4.1	0.2%	SOT23-3L	4.096	B40	-40°C to +125°C
LM4040CELT-4.1	0.5%	SOT23-3L	4.096	C40	-40°C to +125°C
LM4040DELT-4.1	1.0%	SOT23-3L	4.096	D40	-40°C to +125°C
LM4040AECT-4.1	0.1%	SOT323-5L	4.096	A40	-40°C to +125°C
LM4040BECT-4.1	0.2%	SOT323-5L	4.096	A40	-40°C to +125°C
LM4040CECT-4.1	0.5%	SOT323-5L	4.096	C40	-40°C to +125°C
LM4040DECT-4.1	1.0%	SOT323-5L	4.096	D40	-40°C to +125°C
LM4040AELT-5.0	0.1%	SOT23-3L	5.0	A50	-40°C to +125°C
LM4040BELT-5.0	0.2%	SOT23-3L	5.0	B50	-40°C to +125°C
LM4040CELT-5.0	0.5%	SOT23-3L	5.0	C50	-40°C to +125°C
LM4040DELT-5.0	1.0%	SOT23-3L	5.0	D50	-40°C to +125°C
LM4040AECT-5.0	0.1%	SOT323-5L	5.0	A50	-40°C to +125°C
LM4040BECT-5.0	0.2%	SOT323-5L	5.0	A50	-40°C to +125°C



Order codes	Precision (%)	Package	Output voltage (V)	Marking	Temperature range (°C)
LM4040CECT-5.0	0.5%	SOT323-5L	5.0	C50	-40°C to +125°C
LM4040DECT-5.0	1.0%	SOT323-5L	5.0	D50	-40°C to +125°C

## Revision history

**Table 7. Document revision history**

Date	Version	Changes
26-Jan-2021	1	First release.
24-May-2022	2	Updated $I_{kmin}$ unit in table 3. Updated table 4 and 5.
04-Oct-2022	3	Updated Wideband noise unit in <a href="#">Table 4</a> .
29-Jan-2024	4	Updated <a href="#">Table 4</a>

## Contents

<b>1</b>	<b>Pin configuration</b> .....	<b>2</b>
<b>2</b>	<b>Maximum ratings</b> .....	<b>3</b>
<b>3</b>	<b>Electrical characteristics</b> .....	<b>4</b>
<b>4</b>	<b>Typical performance characteristics</b> .....	<b>5</b>
<b>5</b>	<b>Package information</b> .....	<b>7</b>
5.1	SOT23-3L package information .....	7
5.2	SOT323-5L package information .....	9
5.3	SOT23-3L packing information .....	11
5.4	SOT323-5L packing information .....	13
<b>6</b>	<b>Ordering information</b> .....	<b>16</b>
	<b>Revision history</b> .....	<b>18</b>

## List of tables

<b>Table 1.</b>	Absolute maximum ratings . . . . .	3
<b>Table 2.</b>	Thermal data . . . . .	3
<b>Table 3.</b>	Operating conditions . . . . .	3
<b>Table 4.</b>	Electrical characteristics. Limits are 100% production tested at 25 °C. Limits over full temperature range are guaranteed through correlation and by design. $I_k = 10 \mu\text{A}$ , $T_{\text{amb}} = 25 \text{ °C}$ (unless otherwise specified). . . . .	4
<b>Table 5.</b>	SOT23-3L mechanical data . . . . .	8
<b>Table 6.</b>	SOT323-5L mechanical data . . . . .	10
<b>Table 7.</b>	Document revision history . . . . .	18

## List of figures

<b>Figure 1.</b>	Pin configuration SOT23-3L, SOT323-5L (top view) . . . . .	2
<b>Figure 2.</b>	$V_K$ change vs. temperature (5 V version) . . . . .	5
<b>Figure 3.</b>	$V_K$ change vs. temperature (5 V version) . . . . .	5
<b>Figure 4.</b>	$I_{Kmin}$ minimum current for regulation . . . . .	5
<b>Figure 5.</b>	Low frequency noise test . . . . .	5
<b>Figure 6.</b>	Measured dynamic impedance . . . . .	5
<b>Figure 7.</b>	Forward characteristics . . . . .	5
<b>Figure 8.</b>	Turn-on time setting (no Cload ) . . . . .	6
<b>Figure 9.</b>	Turn-on time setting (Cload = 100 nF) . . . . .	6
<b>Figure 10.</b>	Turn-on time setting (Cload = 1 $\mu$ F) . . . . .	6
<b>Figure 11.</b>	Stability plane vs. Cout . . . . .	6
<b>Figure 12.</b>	SOT23-3L package outline . . . . .	7
<b>Figure 13.</b>	SOT23-3L recommended footprint . . . . .	8
<b>Figure 14.</b>	SOT323-5L package outline . . . . .	9
<b>Figure 15.</b>	SOT323-5L recommended footprint . . . . .	10
<b>Figure 16.</b>	SOT23-3L tape outline . . . . .	11
<b>Figure 17.</b>	SOT23-3L reel drawing . . . . .	12
<b>Figure 18.</b>	SOT23-3L tape direction . . . . .	13
<b>Figure 19.</b>	SOT323-5L tape outline . . . . .	13
<b>Figure 20.</b>	SOT323-5L reel drawing . . . . .	14
<b>Figure 21.</b>	SOT323-5L tape direction . . . . .	15

**IMPORTANT NOTICE – READ CAREFULLY**

STMicroelectronics NV and its subsidiaries (“ST”) reserve the right to make changes, corrections, enhancements, modifications, and improvements to ST products and/or to this document at any time without notice. Purchasers should obtain the latest relevant information on ST products before placing orders. ST products are sold pursuant to ST’s terms and conditions of sale in place at the time of order acknowledgment.

Purchasers are solely responsible for the choice, selection, and use of ST products and ST assumes no liability for application assistance or the design of purchasers’ products.

No license, express or implied, to any intellectual property right is granted by ST herein.

Resale of ST products with provisions different from the information set forth herein shall void any warranty granted by ST for such product.

ST and the ST logo are trademarks of ST. For additional information about ST trademarks, refer to [www.st.com/trademarks](http://www.st.com/trademarks). All other product or service names are the property of their respective owners.

Information in this document supersedes and replaces information previously supplied in any prior versions of this document.

© 2024 STMicroelectronics – All rights reserved