



Improved Precision Micropower Shunt Voltage Reference

LM4041

General Description

The LM4041 is a precision two-terminal shunt mode, bandgap voltage reference with a fixed reverse breakdown voltage of 1.225V. Ideal for space-critical applications, the LM4041 is offered in the subminiature 3-pin SC70 surface-mount package (1.8mm × 1.8mm), 50% smaller than comparable devices in SOT23 surface-mount packages (SOT23 versions are also available).

Laser-trimmed resistors ensure precise initial accuracy. With a 100ppm/°C temperature coefficient, the device is offered in four grades of initial accuracy ranging from 0.1% to 1%. The LM4041 has a 60µA to 12mA shunt current capability with low dynamic impedance, ensuring stable reverse breakdown voltage accuracy over a wide range of operating temperatures and currents.

The LM4041 does not require an external stabilizing capacitor while ensuring stability with any capacitive load.

Applications

Portable, Battery-Powered Equipment
 Notebook Computers
 Cell Phones
 Industrial Process Controls

Features

- ◆ Ultra-Small 3-Pin SC70 Package
- ◆ 0.1% max Initial Accuracy
- ◆ 100ppm/°C max Temperature Coefficient
Guaranteed over -40°C to +85°C Temperature Range
- ◆ Wide Operating Current Range: 60µA to 12mA
- ◆ Low 20µVRMS Output Noise (10Hz to 10kHz)
- ◆ 1.225V Fixed Reverse Breakdown Voltage
- ◆ No Output Capacitors Required
- ◆ Tolerates Capacitive Loads

Ordering Information

PART*	TEMP. RANGE	PIN-PACKAGE	TOP MARK
LM4041AIX3-1.2	-40°C to +85°C	3 SC70-3	ABF
LM4041AIM3-1.2	-40°C to +85°C	3 SOT23-3	FZEB
LM4041BIX3-1.2	-40°C to +85°C	3 SC70-3	ABG
LM4041BIM3-1.2	-40°C to +85°C	3 SOT23-3	FZEC
LM4041CIX3-1.2	-40°C to +85°C	3 SC70-3	ABH
LM4041CIM3-1.2	-40°C to +85°C	3 SOT23-3	FZED
LM4041DIX3-1.2	-40°C to +85°C	3 SC70-3	ABI
LM4041DIM3-1.2	-40°C to +85°C	3 SOT23-3	FZEE

*See Selector Guide for a listing of LM4041 Output Voltage, Initial Accuracy, and Temperature Coefficient specifications.

Pin Configuration

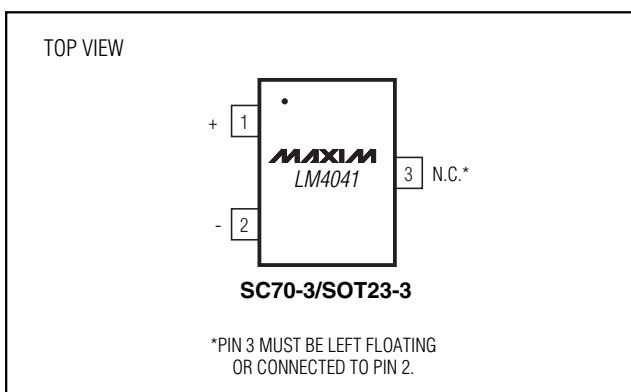

Selector Guide

PART	OUTPUT VOLTAGE (V)	INITIAL ACCURACY (%)	TEMPCO (ppm/°C)
LM4041AIM3-1.2	1.225	0.1	100
LM4041AIX3-1.2	1.225	0.1	100
LM4041BIM3-1.2	1.225	0.2	100
LM4041BIX3-1.2	1.225	0.2	100
LM4041CIM3-1.2	1.225	0.5	100
LM4041CIX3-1.2	1.225	0.5	100
LM4041DIM3-1.2	1.225	1.0	150
LM4041DIX3-1.2	1.225	1.0	150



Maxim Integrated Products 1

For free samples and the latest literature, visit www.maxim-ic.com or phone 1-800-998-8800.
 For small orders, phone 1-800-835-8769.

Improved Precision Micropower Shunt Voltage Reference

ABSOLUTE MAXIMUM RATINGS

Reverse Current (cathode to anode)	20mA
Forward Current (anode to cathode)	10mA
ESD per Method 3015.7	
Human Body Model	2000V
Machine Model.....	200V
Continuous Power Dissipation (T _A = +70°C)	
3-Pin SC70 (derate 2.17mW/°C above +70°C).....	174mW
3-Pin SOT23 (derate 4.01mW/°C above +70°C).....	320mW

Operating Temperature Range	-40°C to +85°C
Storage Temperature Range	-65°C to +150°C
Junction Temperature	+150°C
Lead Temperature (soldering, 10s)	+300°C

Stresses beyond those listed under "Absolute Maximum Ratings" may cause permanent damage to the device. These are stress ratings only, and functional operation of the device at these or any other conditions beyond those indicated in the operational sections of the specifications is not implied. Exposure to absolute maximum rating conditions for extended periods may affect device reliability.

ELECTRICAL CHARACTERISTICS

(I_R = 100μA, T_A = T_{MIN} to T_{MAX}, unless otherwise noted. Typical values are at T_A = +25°C.) (Note 1)

PARAMETER	SYMBOL	CONDITIONS		MIN	TYP	MAX	UNITS
Reverse Breakdown Voltage	V _R	T _A = +25°C			1.225		V
Reverse Breakdown Voltage Tolerance (Note 2)	ΔV _R		LM4041A (0.1%)		±1.2	±9.2	mV
			LM4041B (0.2%)		±2.4	±10.4	
			LM4041C (0.5%)		±6.0	±14	
			LM4041D (1.0%)		±12	±24	
Minimum Operating Current	I _{RMIN}		LM4041A/B/C		45	60	μA
			LM4041D		45	65	
Average Reverse Voltage Temperature Coefficient (Note 2)	ΔV _R /ΔT	I _R = 10mA			±20		ppm/°C
		I _R = 1mA	LM4041A/B/C		±15	±100	
			LM4041D		±15	±150	
I _R = 100μA			±15				
Reverse Breakdown Voltage Change with Operating Current Change	ΔV _R /ΔI _R	I _{RMIN} ≤ I _R ≤ 1mA	LM4041A/B/C		0.7	1.5	mV
			LM4041D		0.7	2.0	
		1mA ≤ I _R ≤ 12mA	LM4041A/B/C		2.5	8.0	
			LM4041D		2.5	10.0	
Reverse Dynamic Impedance (Note 3)	Z _R	I _R = 1mA, f = 120Hz, I _{AC} = 0.1I _R	LM4041A/B/C		0.5	1.5	Ω
			LM4041D		0.5	2.0	
Wideband Noise	e _N	I _R = 100μA, 10Hz ≤ f ≤ 10kHz			20		μV _{RMS}
Reverse Breakdown Voltage Long-Term Stability	ΔV _R	T = 1000h, I _R = 100μA			120		ppm

Note 1: All devices are 100% production tested at +25°C and are guaranteed by design for T_A = T_{MIN} to T_{MAX}, as specified.

Note 2: The overtemperature limit for Reverse Breakdown Voltage Tolerance is defined as the room-temperature Reverse Breakdown Voltage Tolerance ±[(ΔV_R / ΔT)(maxΔT)(V_R)], where ΔV_R / ΔT is the V_R temperature coefficient, maxΔT is the maximum difference in temperature from the reference point of +25°C to T_{MIN} or T_{MAX}, and V_R is the reverse breakdown voltage. The total overtemperature tolerance for the different grades in the temperature range where maxΔT = +65°C is shown below:

- A grade: ±0.75% = ±0.1% ±100 ppm/°C × 65°C
- B grade: ±0.85% = ±0.2% ±100 ppm/°C × 65°C
- C grade: ±1.15% = ±0.5% ±100 ppm/°C × 65°C
- D grade: ±1.98% = ±1.0% ±150 ppm/°C × 65°C

Note 3: Guaranteed by design.

Improved Precision Micropower Shunt Voltage Reference

LM4041

Typical Operating Characteristics

($I_R = 100\mu\text{A}$, SC70-3 package, $T_A = +25^\circ\text{C}$, unless otherwise noted.)

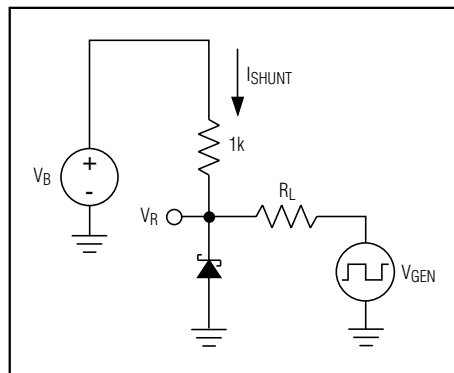
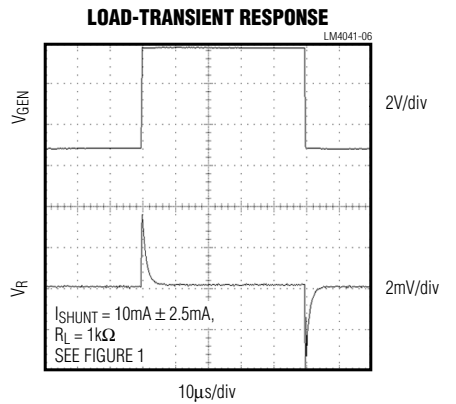
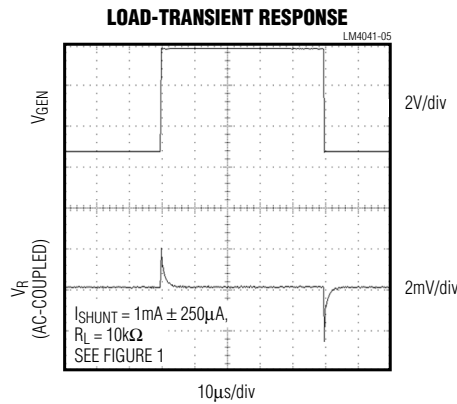
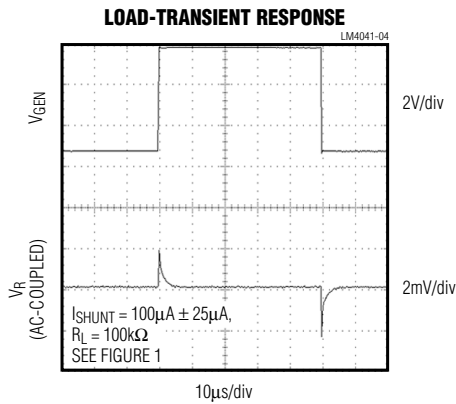
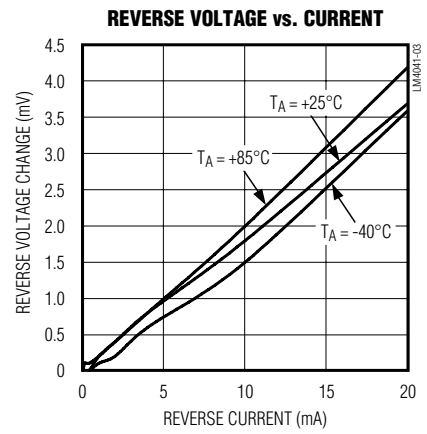
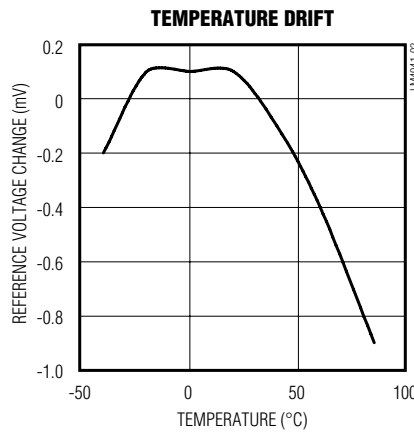
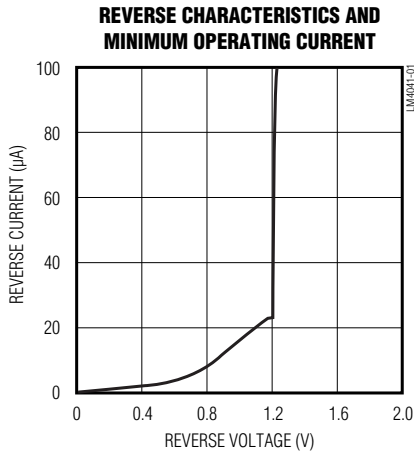

Figure 1. Load-Transient Test Circuit

Improved Precision Micropower Shunt Voltage Reference

Typical Operating Characteristics (continued)

($I_R = 100\mu\text{A}$, SC70-3 package, $T_A = +25^\circ\text{C}$, unless otherwise noted.)

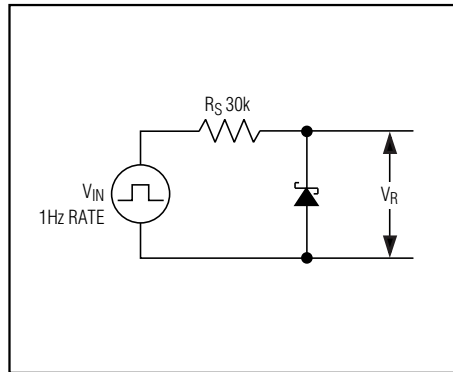
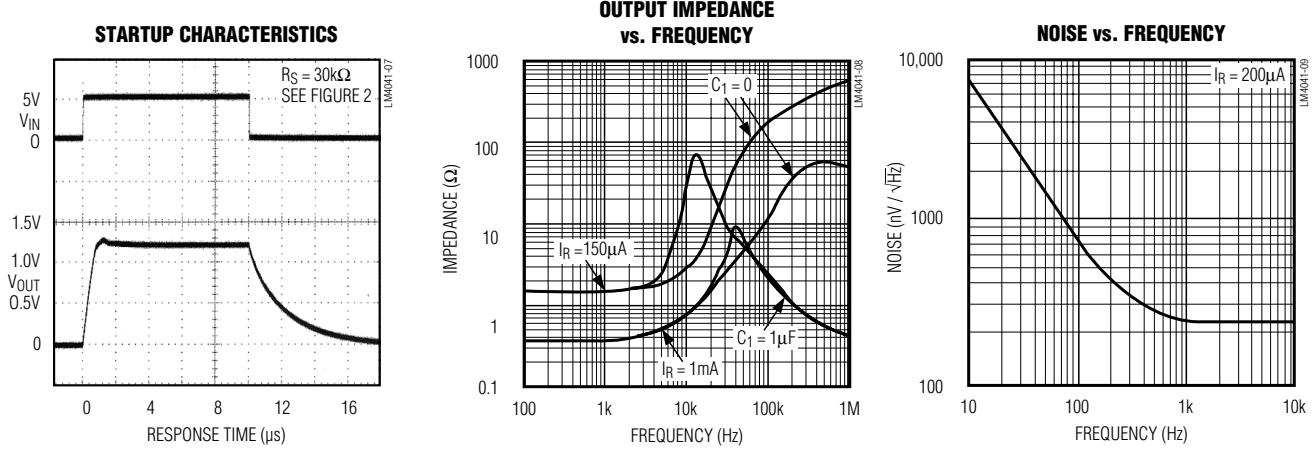

Figure 2. Startup Characteristics Test Circuit

Pin Description

PIN	NAME	FUNCTION
1	+	Positive Terminal of the Shunt Reference
2	-	Negative Terminal of the Shunt Reference
3	N.C.	Leave this pin unconnected, or connect to pin 2.

Improved Precision Micropower Shunt Voltage Reference

LM4041

Detailed Description

The LM4041 shunt references use the bandgap principle to produce a stable, accurate voltage. The device behaves similarly to an ideal zener diode; a fixed voltage of +1.225V is maintained across its output terminals when biased with 60µA to 12mA of reverse current. The LM4041 behaves similarly to a silicon diode when biased with forward currents up to 10mA.

Figure 3 shows a typical operating circuit. The LM4041 is ideal for providing a stable reference from a high-voltage power supply.

Applications Information

The LM4041's internal pass transistor is used to maintain a constant output voltage (V_{SHUNT}) by sinking the necessary amount of current across a source resistor. The source resistance (R_S) is determined from the load current (I_{LOAD}) range, supply voltage (V_S) variations, V_{SHUNT} , and desired quiescent current.

Choose the value of R_S when V_S is at a minimum and I_{LOAD} is at a maximum. Maintain a minimum I_{SHUNT} of 60µA at all times. The R_S value should be large enough to keep I_{SHUNT} less than 12mA for proper regulation when V_S is maximum and I_{LOAD} is at a minimum. To prevent damage to the device, I_{SHUNT} should never exceed 20mA.

Therefore, the value of R_S is bounded by the following equation:

$$\frac{[V_S(\text{MIN}) - V_R]}{[60\mu\text{A} + I_{LOAD(\text{MAX})}]} > R_S > \frac{[V_S(\text{MAX}) - V_R]}{[20\text{mA} + I_{LOAD(\text{MIN})}]}$$

Choosing a larger resistance minimizes the total power dissipation in the circuit by reducing the shunt current ($P_{D(\text{TOTAL})} = V_S \times I_{SHUNT}$). Provide a safety margin to incorporate the worst-case tolerance of the resistor used. Ensure that the resistor's power rating is adequate, using the following general power equation:

$$P_R = I_{SHUNT} \times (V_S(\text{MAX}) - V_R)$$

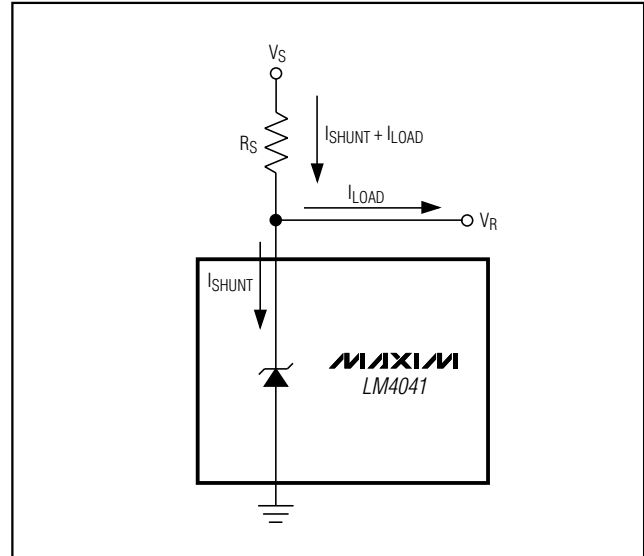

Figure 3. Typical Operating Circuit

Output Capacitance

The LM4041 does not require an external capacitor for frequency stability and is stable for any output capacitance.

Temperature Performance

The LM4041 typically exhibits an output voltage temperature coefficient within $\pm 15\text{ppm}/^\circ\text{C}$. The polarity of the temperature coefficient may be different from one device to another; some may have positive coefficients, and others may have negative coefficients.

Chip Information

TRANSISTOR COUNT: 60

PROCESS: BiCMOS

Improved Precision Micropower Shunt Voltage Reference

Package Information

NOTES:

1. D&E DO NOT INCLUDE MOLD FLASH.
2. MOLD FLASH OR PROTRUSIONS NOT TO EXCEED .15mm (.006")
3. CONTROLLING DIMENSION: MILLIMETER

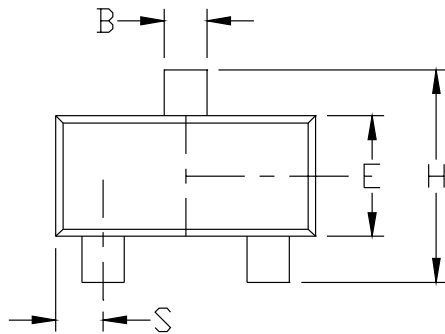

DIM	INCHES		MILLIMETERS	
	MIN	MAX	MIN	MAX
A	0.031	0.047	0.787	1.194
A1	0.001	0.005	0.025	0.127
B	0.014	0.022	0.356	0.559
C	0.0034	0.006	0.086	0.152
D	0.105	0.120	2.667	3.048
E	0.047	0.055	1.194	1.397
e	0.070	0.080	1.778	2.032
H	0.082	0.098	2.083	2.489
L	0.004	0.012	0.102	0.305
S	0.017	0.022	0.432	0.559
α	0°	8°	0°	8°

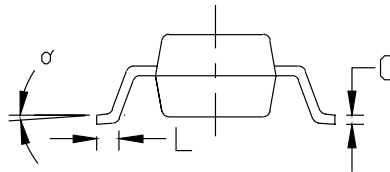
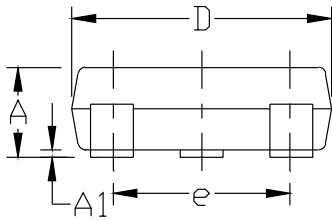

MAXIM			
<small>PROPRIETARY INFORMATION</small>			
<small>TITLE:</small>			
PACKAGE OUTLINE, SOT-23, 3L			
<small>APPROVAL</small>	<small>DOCUMENT CONTROL NO.</small>	<small>REV</small>	<small>1/1</small>
	21-0051	C	

SOT23-3L

Improved Precision Micropower Shunt Voltage Reference

Package Information (continued)

LM4041

SC70, 3L-EPS

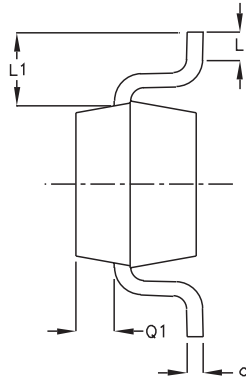
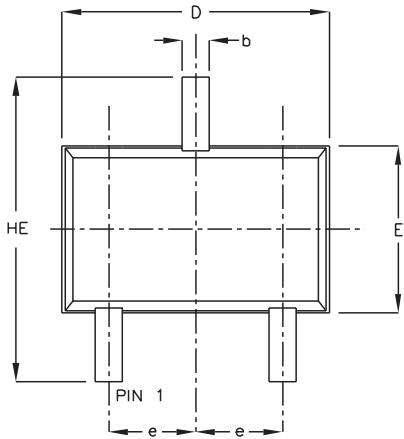

SYMBOL	MIN	MAX
e	0.65	BSC
D	1.80	2.20
b	0.25	0.40
E	1.15	1.35
HE	1.80	2.40
Q1	0.10	0.40
A2	0.80	1.00
A1	0.00	0.10
A	0.80	1.10
c	0.10	0.18
L	0.10	0.30
L1	0.425	TYP.

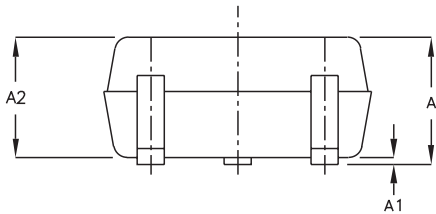

NOTE:

1. ALL DIMENSIONS ARE IN MILLIMETERS
2. DIMENSIONS ARE INCLUSIVE OF PLATING
3. DIMENSIONS ARE EXCLUSIVE OF MOLD FLASH & METAL BURR
4. ALL SPECIFICATIONS COMPLY TO EIAJ SC70
5. COPLANARITY 4 MILS. MAX.

MAXIM		
<small>PROPRIETARY INFORMATION</small>		
<small>TITLE:</small>		
PACKAGE OUTLINE, SC70, 3L		
<small>APPROVAL</small>	<small>DOCUMENT CONTROL NO.</small>	<small>REV</small>
	21-0075	B 1/1

LM4041

Improved Precision Micropower Shunt Voltage Reference

NOTES

Maxim cannot assume responsibility for use of any circuitry other than circuitry entirely embodied in a Maxim product. No circuit patent licenses are implied. Maxim reserves the right to change the circuitry and specifications without notice at any time.

8 _____ **Maxim Integrated Products, 120 San Gabriel Drive, Sunnyvale, CA 94086 408-737-7600**