

## LM4250 Programmable Operational Amplifier

### General Description

The LM4250 and LM4250C are extremely versatile programmable monolithic operational amplifiers. A single external master bias current setting resistor programs the input bias current, input offset current, quiescent power consumption, slew rate, input noise, and the gain-bandwidth product. The device is a truly general purpose operational amplifier.

The LM4250C is identical to the LM4250 except that the LM4250C has its performance guaranteed over a 0°C to +70°C temperature range instead of the -55°C to +125°C temperature range of the LM4250.

### Features

- ±1V to ±18V power supply operation
- 3 nA input offset current
- Standby power consumption as low as 500 nW
- No frequency compensation required
- Programmable electrical characteristics
- Offset voltage nulling capability
- Can be powered by two flashlight batteries
- Short circuit protection

### Connection Diagrams

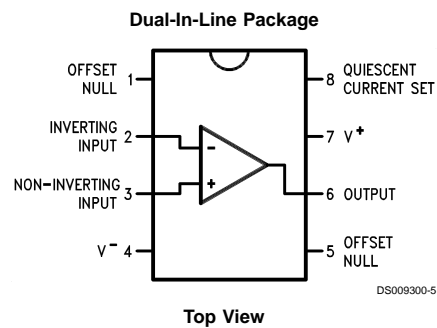
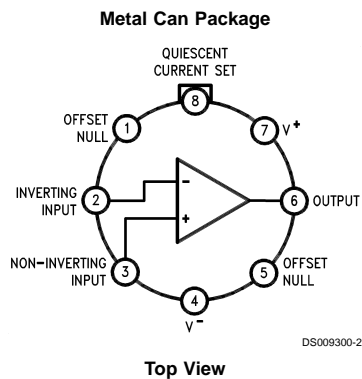

### Ordering Information

Temperature Range		Package	NSC Package Number
Military -55°C ≤ T <sub>A</sub> ≤ +125°C	Commercial 0°C ≤ T <sub>A</sub> ≤ +70°C		
	LM4250CN	8-Pin Molded DIP	N08E
	LM4250CM	8-Pin Surface Mount	M08A
LM4250J LM4250J-MIL		8-Pin Ceramic DIP	J08E
LM4250H LM4250H-MIL	LM4250CH	8-Pin Metal Can	H08C

## Absolute Maximum Ratings (Note 1)

If Military/Aerospace specified devices are required, please contact the National Semiconductor Sales Office/Distributors for availability and specifications.

(Note 3)

	LM4250	LM4250C
Supply Voltage	±18V	±18V
Operating Temp. Range	-55°C ≤ T <sub>A</sub> ≤ +125°C	0°C ≤ T <sub>A</sub> ≤ +70°C
Differential Input Voltage	±30V	±30V
Input Voltage (Note 2)	±15V	±15V
I <sub>SET</sub> Current	150 nA	150 nA
Output Short Circuit Duration	Continuous	Continuous
T <sub>JMAX</sub>		
H-Package	150°C	100°C
N-Package		100°C
J-Package	150°C	100°C
M-Package		100°C
Power Dissipation at T <sub>A</sub> = 25°C		
H-Package (Still Air)	500 mW	300 mW
(400 LF/Min Air Flow)	1200 mW	1200 mW
N-Package		500 mW
J-Package	1000 mW	600 mW
M-Package		350 mW
Thermal Resistance (Typical) θ <sub>JA</sub>		
H-Package (Still Air)	165°C/W	165°C/W
(400 LF/Min Air Flow)	65°C/W	65°C/W
N-Package		130°C/W
J-Package	108°C/W	108°C/W
M-Package		190°C/W
(Typical) θ <sub>JC</sub>		
H-Package	21°C/W	21°C/W
Storage Temperature Range	-65°C to +150°C	-65°C to +150°C
Soldering Information		
Dual-In-Line Package		
Soldering (10 seconds)	260°C	
Small Outline Package		
Vapor Phase (60 seconds)	215°C	
Infrared (15 seconds)	220°C	
See AN-450 "Surface Mounting Methods and Their Effect on Product Reliability" for other methods of soldering surface mount devices.		
ESD tolerance (Note 4)	800V	

**Note 1:** "Absolute Maximum Ratings" indicate limits beyond which damage to the device may occur. Operating Ratings indicate conditions for which the device is functional, but do not guarantee specific performance limits.

**Note 2:** For supply voltages less than ±15V, the absolute maximum input voltage is equal to the supply voltage.

**Note 3:** Refer to RETS4250X for military specifications.

**Note 4:** Human body model, 1.5 kΩ in series with 100 pF.

## Resistor Biasing

### Set Current Setting Resistor to $V^-$

$V_S$	$I_{SET}$				
	0.1 $\mu A$	0.5 $\mu A$	1.0 $\mu A$	5 $\mu A$	10 $\mu A$
$\pm 1.5V$	25.6 M $\Omega$	5.04 M $\Omega$	2.5 M $\Omega$	492 k $\Omega$	244 k $\Omega$
$\pm 3.0V$	55.6 M $\Omega$	11.0 M $\Omega$	5.5 M $\Omega$	1.09 M $\Omega$	544 k $\Omega$
$\pm 6.0V$	116 M $\Omega$	23.0 M $\Omega$	11.5 M $\Omega$	2.29 M $\Omega$	1.14 M $\Omega$
$\pm 9.0V$	176 M $\Omega$	35.0 M $\Omega$	17.5 M $\Omega$	3.49 M $\Omega$	1.74 M $\Omega$
$\pm 12.0V$	236 M $\Omega$	47.0 M $\Omega$	23.5 M $\Omega$	4.69 M $\Omega$	2.34 M $\Omega$
$\pm 15.0V$	296 M $\Omega$	59.0 M $\Omega$	29.5 M $\Omega$	5.89 M $\Omega$	2.94 M $\Omega$

## Electrical Characteristics

LM4250 ( $-55^\circ C \leq T_A \leq +125^\circ C$  unless otherwise specified.)  $T_A = T_J$

Parameter	Conditions	$V_S = \pm 1.5V$			
		$I_{SET} = 1 \mu A$		$I_{SET} = 10 \mu A$	
		Min	Max	Min	Max
$V_{OS}$	$R_S \leq 100 k\Omega$ , $T_A = 25^\circ C$		3 mV		5 mV
$I_{OS}$	$T_A = 25^\circ C$		3 nA		10 nA
$I_{bias}$	$T_A = 25^\circ C$		7.5 nA		50 nA
Large Signal Voltage Gain	$R_L = 100 k\Omega$ , $T_A = 25^\circ C$ $V_O = \pm 0.6V$ , $R_L = 10 k\Omega$	40k		50k	
Supply Current	$T_A = 25^\circ C$		7.5 $\mu A$		80 $\mu A$
Power Consumption	$T_A = 25^\circ C$		23 $\mu W$		240 $\mu W$
$V_{OS}$	$R_S \leq 100 k\Omega$		4 mV		6 mV
$I_{OS}$	$T_A = +125^\circ C$ $T_A = -55^\circ C$		5 nA 3 nA		10 nA 10 nA
$I_{bias}$			7.5 nA		50 nA
Input Voltage Range		$\pm 0.6V$		$\pm 0.6V$	
Large Signal Voltage Gain	$V_O = \pm 0.5V$ , $R_L = 100 k\Omega$ $R_L = 10 k\Omega$	30k		30k	
Output Voltage Swing	$R_L = 100 k\Omega$ $R_L = 10 k\Omega$	$\pm 0.6V$		$\pm 0.6V$	
Common Mode Rejection Ratio	$R_S \leq 10 k\Omega$	70 dB		70 dB	
Supply Voltage Rejection Ratio	$R_S \leq 10 k\Omega$	76 dB		76 dB	
Supply Current			8 $\mu A$		90 $\mu A$

Parameter	Conditions	$V_S = \pm 15V$			
		$I_{SET} = 1 \mu A$		$I_{SET} = 10 \mu A$	
		Min	Max	Min	Max
$V_{OS}$	$R_S \leq 100 k\Omega$ , $T_A = 25^\circ C$		3 mV		5 mV
$I_{OS}$	$T_A = 25^\circ C$		3 nA		10 nA
$I_{bias}$	$T_A = 25^\circ C$		7.5 nA		50 nA
Large Signal Voltage Gain	$R_L = 100 k\Omega$ , $T_A = 25^\circ C$ $V_O = \pm 10V$ , $R_L = 10 k\Omega$	100k		100k	
Supply Current	$T_A = 25^\circ C$		10 $\mu A$		90 $\mu A$
Power Consumption	$T_A = 25^\circ C$		300 $\mu W$		2.7 mW
$V_{OS}$	$R_S \leq 100 k\Omega$		4 mV		6 mV
$I_{OS}$	$T_A = +125^\circ C$ $T_A = -55^\circ C$		25 nA 3 nA		25 nA 10 nA
$I_{bias}$			7.5 nA		50 nA
Input Voltage Range		$\pm 13.5V$		$\pm 13.5V$	

## Electrical Characteristics (Continued)

Parameter	Conditions	$V_S = \pm 15V$			
		$I_{SET} = 1 \mu A$		$I_{SET} = 10 \mu A$	
		Min	Max	Min	Max
Large Signal Voltage Gain	$V_O = \pm 10V, R_L = 100 k\Omega$ $R_L = 10 k\Omega$	50k		50k	
Output Voltage Swing	$R_L = 100 k\Omega$ $R_L = 10 k\Omega$	$\pm 12V$		$\pm 12V$	
Common Mode Rejection Ratio	$R_S \leq 10 k\Omega$	70 dB		70 dB	
Supply Voltage Rejection Ratio	$R_S \leq 10 k\Omega$	76 dB		76 dB	
Supply Current			11 $\mu A$		100 $\mu A$
Power Consumption			330 $\mu W$		3 mW

## Electrical Characteristics

LM4250C ( $0^\circ C \leq T_A \leq +70^\circ C$  unless otherwise specified.)  $T_A = T_J$

Parameter	Conditions	$V_S = \pm 1.5V$			
		$I_{SET} = 1 \mu A$		$I_{SET} = 10 \mu A$	
		Min	Max	Min	Max
$V_{OS}$	$R_S \leq 100 k\Omega, T_A = 25^\circ C$		5 mV		6 mV
$I_{OS}$	$T_A = 25^\circ C$		6 nA		20 nA
$I_{bias}$	$T_A = 25^\circ C$		10 nA		75 nA
Large Signal Voltage Gain	$R_L = 100 k\Omega, T_A = 25^\circ C$ $V_O = \pm 0.6V, R_L = 10 k\Omega$	25k		25k	
Supply Current	$T_A = 25^\circ C$		8 $\mu A$		90 $\mu A$
Power Consumption	$T_A = 25^\circ C$		24 $\mu W$		270 $\mu W$
$V_{OS}$	$R_S \leq 10 k\Omega$		6.5 mV		7.5 mV
$I_{OS}$			8 nA		25 nA
$I_{bias}$			10 nA		80 nA
Input Voltage Range		$\pm 0.6V$		$\pm 0.6V$	
Large Signal Voltage Gain	$V_O = \pm 0.5V, R_L = 100 k\Omega$ $R_L = 10 k\Omega$	25k		25k	
Output Voltage Swing	$R_L = 100 k\Omega$ $R_L = 10 k\Omega$	$\pm 0.6V$		$\pm 0.6V$	
Common Mode Rejection Ratio	$R_S \leq 10 k\Omega$	70 dB		70 dB	
Supply Voltage Rejection Ratio	$R_S \leq 10 k\Omega$	74 dB		74 dB	
Supply Current			8 $\mu A$		90 $\mu A$
Power Consumption			24 $\mu W$		270 $\mu W$

Parameter	Conditions	$V_S = \pm 15V$			
		$I_{SET} = 1 \mu A$		$I_{SET} = 10 \mu A$	
		Min	Max	Min	Max
$V_{OS}$	$R_S \leq 100 k\Omega, T_A = 25^\circ C$		5 mV		6 mV
$I_{OS}$	$T_A = 25^\circ C$		6 nA		20 nA
$I_{bias}$	$T_A = 25^\circ C$		10 nA		75 nA
Large Signal Voltage Gain	$R_L = 100 k\Omega, T_A = 25^\circ C$ $V_O = \pm 10V, R_L = 10 k\Omega$	60k		60k	
Supply Current	$T_A = 25^\circ C$		11 $\mu A$		100 $\mu A$
Power Consumption	$T_A = 25^\circ C$		330 $\mu W$		3 mW
$V_{OS}$	$R_S \leq 100 k\Omega$		6.5 mV		7.5 mV
$I_{OS}$			8 nA		25 nA
$I_{bias}$			10 nA		80 nA

## Electrical Characteristics (Continued)

Parameter	Conditions	$V_S = \pm 15V$			
		$I_{SET} = 1 \mu A$		$I_{SET} = 10 \mu A$	
		Min	Max	Min	Max
Input Voltage Range		$\pm 13.5V$		$\pm 13.5V$	
Large Signal Voltage Gain	$V_O = \pm 10V, R_L = 100 k\Omega$ $R_L = 10 k\Omega$	50k		50k	
Output Voltage Swing	$R_L = 100 k\Omega$ $R_L = 10 k\Omega$	$\pm 12V$		$\pm 12V$	
Common Mode Rejection Ratio	$R_S \leq 10 k\Omega$	70 dB		70 dB	
Supply Voltage Rejection Ratio	$R_S \leq 10 k\Omega$	74 dB		74 dB	
Supply Current		11 $\mu A$		100 $\mu A$	
Power Consumption		330 $\mu W$		3 mW	

## Typical Performance Characteristics

Input Bias Current vs  $I_{SET}$

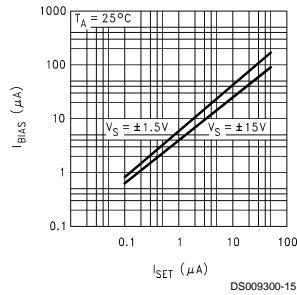

Input Bias Current vs Temperature

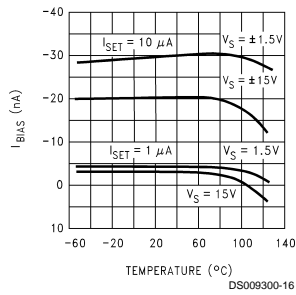

Input Offset Current vs Temperature

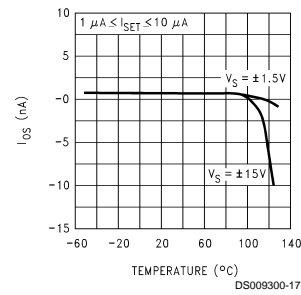

Unnull'd Input Offset Voltage Change vs  $I_{SET}$

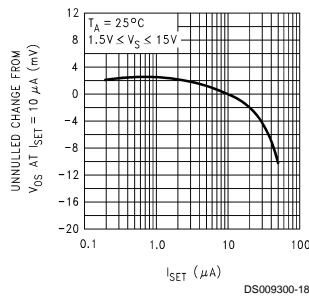

Unnull'd Input Offset Voltage Change vs Temperature

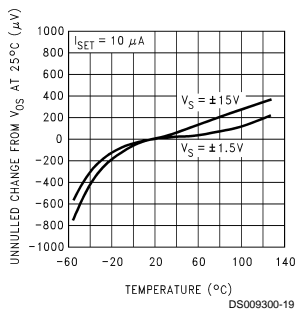

Peak to Peak Output Voltage Swing vs Load Resistance

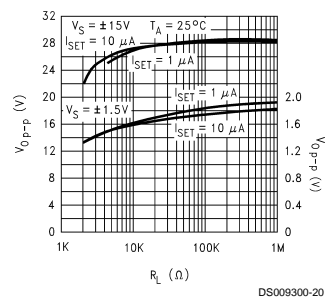

## Typical Performance Characteristics (Continued)

**Peak to Peak Output Voltage Swing vs Supply Voltage**

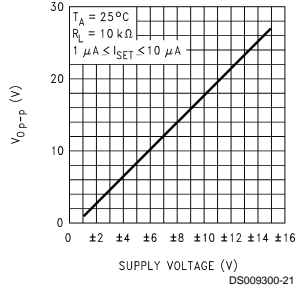

**Quiescent Current ( $I_q$ ) vs Temperature**

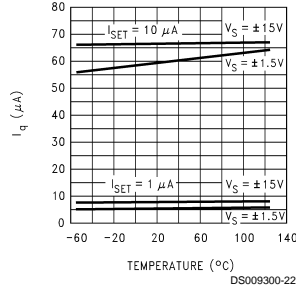

**Quiescent Current ( $I_q$ ) vs  $I_{\text{SET}}$**

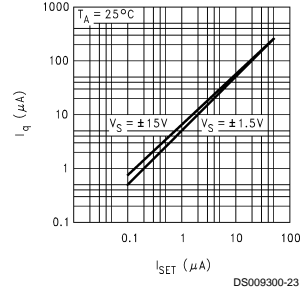

**Slew Rate vs  $I_{\text{SET}}$**

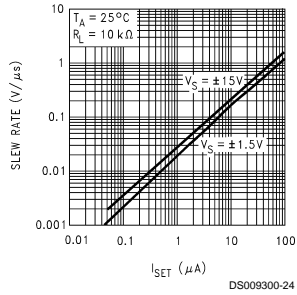

**Gain Bandwidth Product vs  $I_{\text{SET}}$**

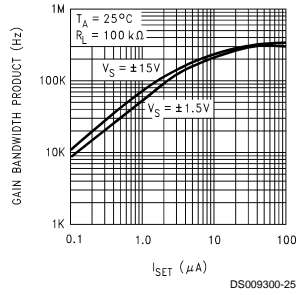

**Open Loop Voltage Gain vs  $I_{\text{SET}}$**

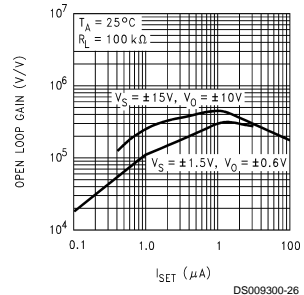

**Phase Margin vs  $I_{\text{SET}}$**

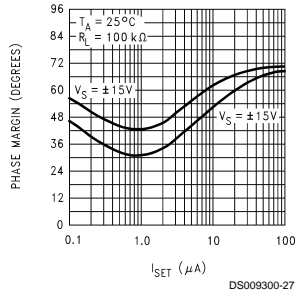

**Input Noise Current ( $I_n$ ) and Voltage ( $E_n$ ) vs Frequency**

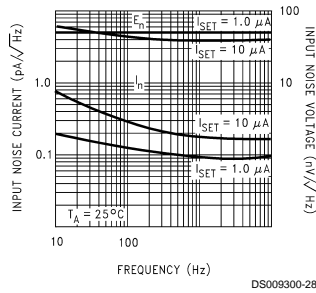

**$R_{\text{SET}}$  vs  $I_{\text{SET}}$**

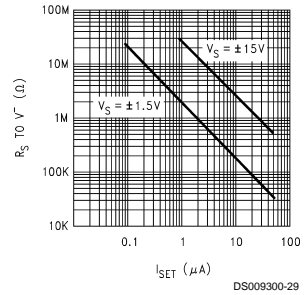

## Typical Applications

### X5 Difference Amplifier

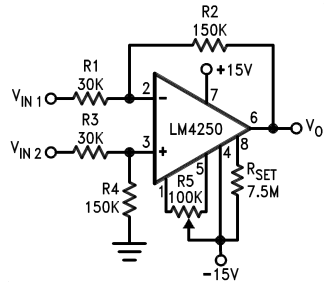

DS009300-3

Quiescent  $P_D = 0.6 \text{ mW}$

### 500 Nano-Watt X10 Amplifier

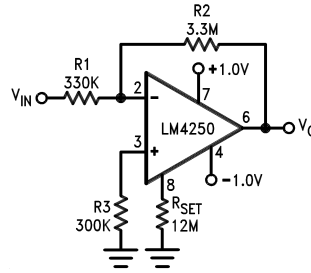

DS009300-4

Quiescent  $P_D = 500 \text{ nW}$

### Floating Input Meter Amplifier 100 nA full Scale

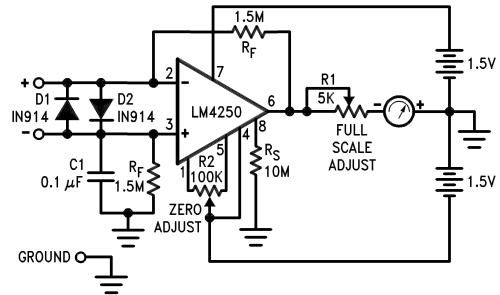

DS009300-8

Quiescent  $P_D = 1.8 \mu\text{W}$

\*Meter movement (0–100  $\mu\text{A}$ , 2  $\text{k}\Omega$ ) marked for 0–100 nA full scale.

## Typical Applications (Continued)

### X100 Instrumentation Amplifier 10 $\mu$ W

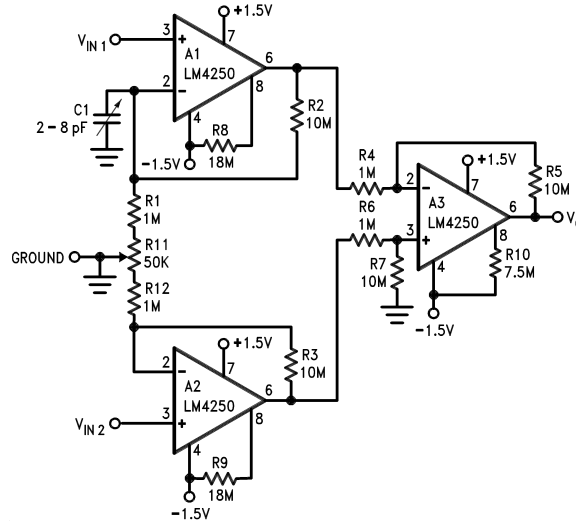

DS009300-9

**Note 5:** Quiescent  $P_D = 10 \mu$ W.

**Note 6:** R2, R3, R4, R5, R6 and R7 are 1% resistors.

**Note 7:** R11 and C1 are for DC and AC common mode rejection adjustments.

#### $R_{SET}$ Connected to $V^-$

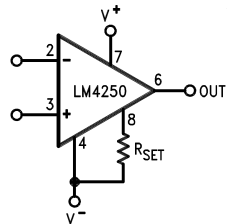

DS009300-10

#### $R_{SET}$ Connected to Ground

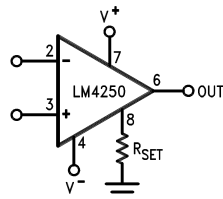

DS009300-11

$I_{SET}$  Equations:

$$I_{SET} \approx \frac{V^+ + |V^-| - 0.5}{R_{SET}} \quad \text{where } R_{SET} \text{ is connected to } V^-.$$

$$I_{SET} \approx \frac{V^+ - 0.5}{R_{SET}} \quad \text{where } R_{SET} \text{ is connected to ground.}$$

DS009300-30

#### Transistor Current Sourcing Biasing

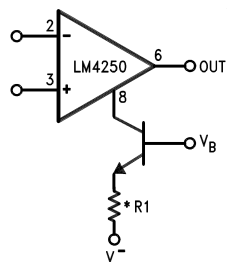

DS009300-12

\*R1 limits  $I_{SET}$  maximum

#### FET Current Sourcing Biasing

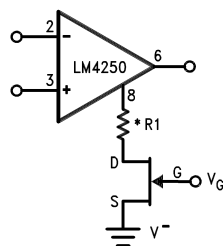

DS009300-13

#### Offset Null Circuit

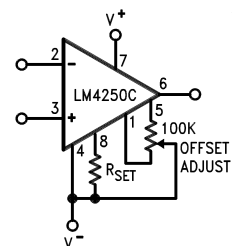

DS009300-14



# Schematic Diagram

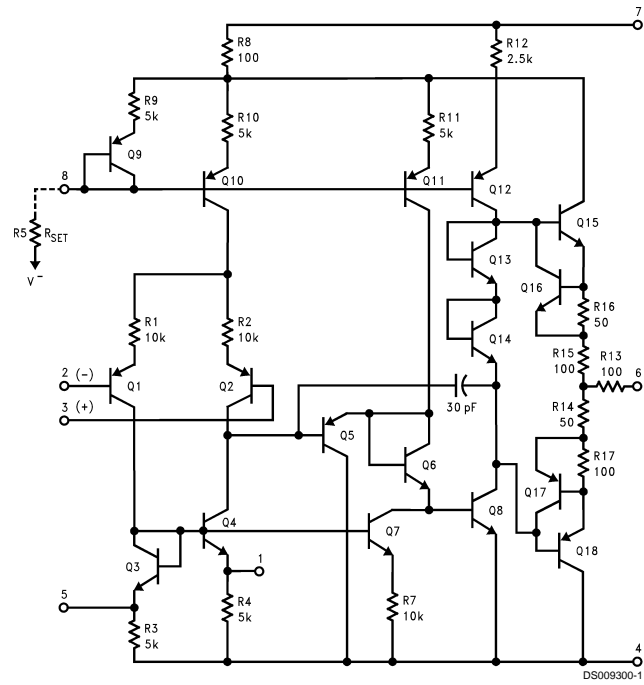

**Physical Dimensions** inches (millimeters) unless otherwise noted

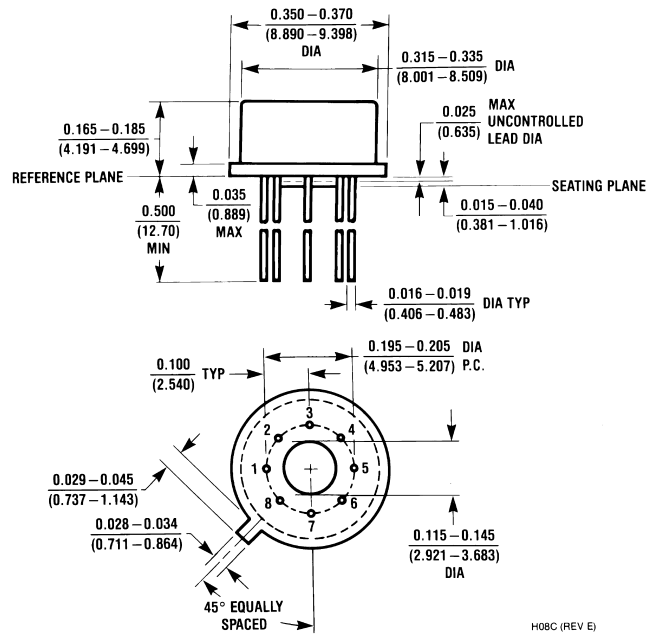

**Metal Can Package (H)**  
 Order Number LM4250H, LM4250CH or LM4250H-MIL  
 NS Package Number H08C

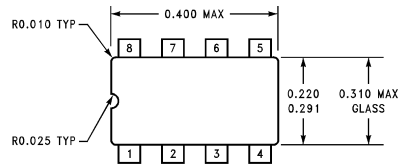

**Ceramic Dual-In-Line Package (J)**  
 Order Number LM4250J, or LM4250J-MIL  
 NS Package Number J08A

**Physical Dimensions** inches (millimeters) unless otherwise noted (Continued)

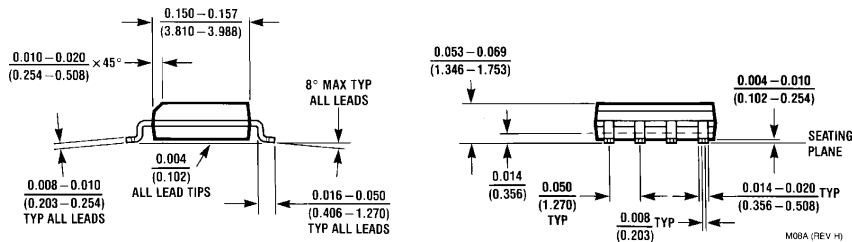
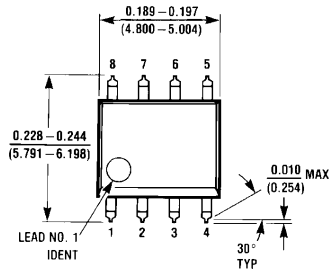

**Small Outline Package (M)**  
**Order Number LM4250M**  
**NS Package Number M08A**

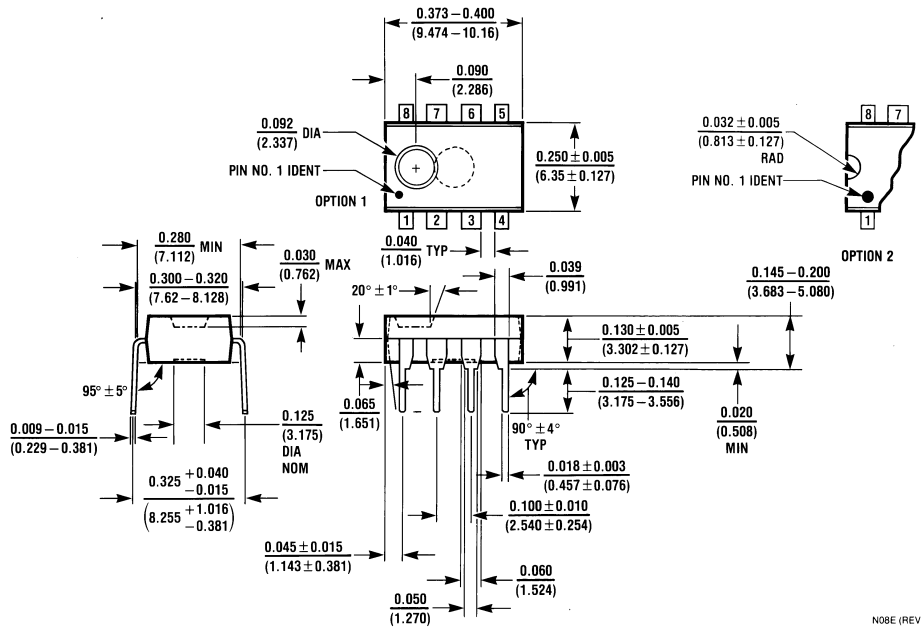

**Molded Dual-In-Line Package (N)**  
**Order Number LM4250CN**  
**NS Package Number N08E**

## Notes

### LIFE SUPPORT POLICY

NATIONAL'S PRODUCTS ARE NOT AUTHORIZED FOR USE AS CRITICAL COMPONENTS IN LIFE SUPPORT DEVICES OR SYSTEMS WITHOUT THE EXPRESS WRITTEN APPROVAL OF THE PRESIDENT OF NATIONAL SEMICONDUCTOR CORPORATION. As used herein:

1. Life support devices or systems are devices or systems which, (a) are intended for surgical implant into the body, or (b) support or sustain life, and whose failure to perform when properly used in accordance with instructions for use provided in the labeling, can be reasonably expected to result in a significant injury to the user.
2. A critical component is any component of a life support device or system whose failure to perform can be reasonably expected to cause the failure of the life support device or system, or to affect its safety or effectiveness.



**National Semiconductor Corporation**  
Americas  
Tel: 1-800-272-9959  
Fax: 1-800-737-7018  
Email: support@nsc.com

[www.national.com](http://www.national.com)

**National Semiconductor Europe**  
Fax: +49 (0) 1 80-530 85 86  
Email: europe.support@nsc.com  
Deutsch Tel: +49 (0) 1 80-530 85 85  
English Tel: +49 (0) 1 80-532 78 32  
Français Tel: +49 (0) 1 80-532 93 58  
Italiano Tel: +49 (0) 1 80-534 16 80

**National Semiconductor Asia Pacific Customer Response Group**  
Tel: 65-2544466  
Fax: 65-2504466  
Email: sea.support@nsc.com

**National Semiconductor Japan Ltd.**  
Tel: 81-3-5639-7560  
Fax: 81-3-5639-7507