

# Programmable Shunt Regulator

## LM431SA, LM431SB, LM431SC

### Description

The LM431SA / LM431SB / LM431SC are three-terminal the output adjustable regulators with thermal stability over operating temperature range. The output voltage can be set any value between  $V_{REF}$  (approximately 2.5 V) and 36 V with two external resistors. These devices have a typical dynamic output impedance of 0.2  $\Omega$ . Active output circuit provides a sharp turn-on characteristic, making these devices excellent replacement for zener diodes in many applications.

### Features

- Programmable Output Voltage to 36 V
- Low Dynamic Output Impedance: 0.2  $\Omega$  (Typical)
- Sink Current Capability: 1.0 to 100 mA
- Equivalent Full-Range Temperature Coefficient of 50 ppm/ $^{\circ}$ C (Typical)
- Temperature Compensated for Operation Over Full Rated Operating Temperature Range
- Low Output Noise Voltage
- Fast Turn-on Response
- These Devices are Pb-Free, Halogen Free/BFR Free and are RoHS Compliant

### ORDERING INFORMATION

Product Number	Output Voltage Tolerance	Operating Temperature	Top Mark <sup>(1)</sup>	Package	Shipping <sup>†</sup>
LM431SACMFX	2%	-25 to +85 $^{\circ}$ C	43A $\square$	SOT-23FL 3L	Tape and Reel
LM431SACM3X			43L $\odot$	SOT-23 3L	
LM431SACM32X			43G $\odot$	SOT-23 3L	
LM431SBCMFX	1%		43B $\square$	SOT-23FL 3L	
LM431SBCM3X			43M $\odot$	SOT-23 3L	
LM431SBCM32X			43H $\odot$	SOT-23 3L	
LM431SCCMLX	0.5%		43C	SOT-89 3L	
LM431SCCMFX			43C $\square$	SOT-23FL 3L	
LM431SCCM3X			43N $\odot$	SOT-23 3L	
LM431SCCM32X		43J $\odot$	SOT-23 3L		
LM431SAIMFX	2%	-40 to +85 $^{\circ}$ C	43AI	SOT-23FL 3L	
LM431SBIMFX	1%		43BI	SOT-23FL 3L	
LM431SCIMFX	0.5%		43CI	SOT-23FL 3L	

<sup>†</sup>For information on tape and reel specifications, including part orientation and tape sizes, please refer to our Tape and Reel Packaging Specification Brochure, BRD8011/D.

1. SOT-23 and SOT-23FL have basically four-character marking except LM431SAIMFX. (3 letters for device code + 1 letter for date code) SOT-23FL date code is composed of 1 digit numeric or alphabetic week code adding bar-type year code.

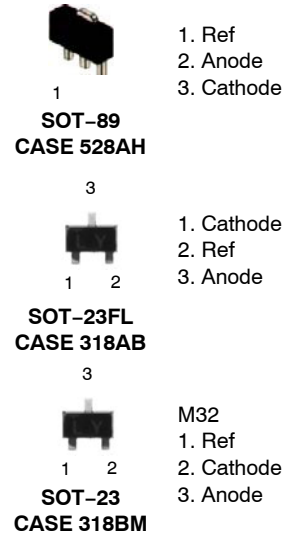

# LM431SA, LM431SB, LM431SC

## BLOCK DIAGRAM

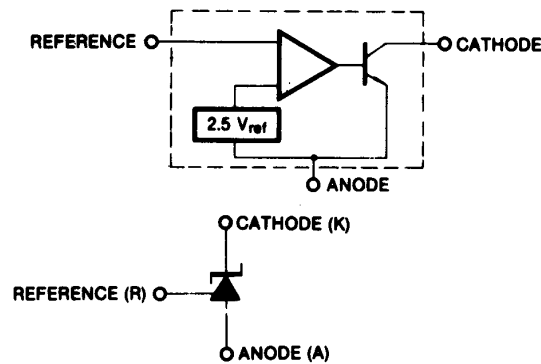

Figure 1. Block Diagram

### ABSOLUTE MAXIMUM RATINGS ( $T_A = 25^\circ\text{C}$ unless otherwise noted)

Symbol	Parameter		Value	Unit
$V_{KA}$	Cathode Voltage		37	V
$I_{KA}$	Cathode current Range (Continuous)		-100 to +150	mA
$I_{REF}$	Reference Input Current Range		-0.05 to +10.00	mA
$R_{\theta JA}$	Thermal Resistance Junction-Air <sup>(2, 3)</sup>	ML Suffix Package (SOT-89)	220	$^\circ\text{C}/\text{W}$
		MF Suffix Package (SOT-23FL)	350	
		M32, M3 Suffix Package (SOT-23)	400	
$P_D$	Power Dissipation <sup>(4, 5)</sup>	ML Suffix Package (SOT-89)	560	mW
		MF Suffix Package (SOT-23FL)	350	
		M32, M3 Suffix Package (SOT-23)	310	
$T_J$	Junction Temperature		150	$^\circ\text{C}$
$T_{OPR}$	Operating Temperature Range	All products except LM431SAIMFX	-25 to +85	$^\circ\text{C}$
		LM431SAIMFX, SBIMFX, SCIMFX	-40 to +85	
$T_{STG}$	Storage Temperature Range		-65 to +150	$^\circ\text{C}$

Stresses exceeding those listed in the Maximum Ratings table may damage the device. If any of these limits are exceeded, device functionality should not be assumed, damage may occur and reliability may be affected.

2. Thermal resistance test board

Size: 1.6 mm x 76.2 mm x 114.3 mm (1S0P) JEDEC Standard: JESD51-3, JESD51-7.

3. Assume no ambient airflow.

4.  $T_{JMAX} = 150^\circ\text{C}$ ; ratings apply to ambient temperature at  $25^\circ\text{C}$ .

5. Power dissipation calculation:  $P_D = (T_J - T_A) / R_{\theta JA}$ .

### RECOMMENDED OPERATING CONDITIONS

Symbol	Parameter	Min.	Max.	Unit
$V_{KA}$	Cathode Voltage	$V_{REF}$	36	V
$I_{KA}$	Cathode Current	1	100	mA

Functional operation above the stresses listed in the Recommended Operating Ranges is not implied. Extended exposure to stresses beyond the Recommended Operating Ranges limits may affect device reliability.

# LM431SA, LM431SB, LM431SC

## ELECTRICAL CHARACTERISTICS (Note 6, Values are at $T_A = 25^\circ\text{C}$ unless otherwise noted)

Symbol	Parameter	Conditions	LM431SA			LM431SB			LM431SC			Unit	
			Min.	Typ.	Max.	Min.	Typ.	Max.	Min.	Typ.	Max.		
$V_{REF}$	Reference Input Voltage	$V_{KA} = V_{REF}, I_{KA} = 10\text{ mA}$	2.450	2.500	2.550	2.470	2.495	2.520	2.482	2.495	2.508	V	
$\Delta V_{REF} / \Delta T$	Deviation of Reference Input Voltage Over Temperature	$V_{KA} = V_{REF}, I_{KA} = 10\text{ mA}, T_{MIN} \leq T_A \leq T_{MAX}$	SOT-89 SOT-23FL		4.5	17.0		4.5	17.0		4.5	17.0	mV
			SOT-23		6.6	24		6.6	24		6.6	24	mV
$\frac{\Delta V_{REF}}{\Delta V_{KA}}$	Ratio of Change in Reference Input Voltage to the Change in Cathode Voltage	$I_{KA} = 10\text{ mA}$	$\Delta V_{KA} = 10\text{ V} - V_{REF}$		-1.0	-2.7		-1.0	-2.7		-1.0	-2.7	mV/V
			$\Delta V_{KA} = 36\text{ V} - 10\text{ V}$		-0.5	-2.0		-0.5	-2.0		-0.5	-2.0	
$I_{REF}$	Reference Input Current	$I_{KA} = 10\text{ mA}, R_1 = 10\text{ K}\Omega, R_2 = \infty$		1.5	4.0		1.5	4.0		1.5	4.0	$\mu\text{A}$	
$\Delta I_{REF} / \Delta T$	Deviation of Reference Input Current Over Full Temperature Range	$I_{KA} = 10\text{ mA}, R_1 = 10\text{ K}\Omega, R_2 = \infty, T_A = \text{Full Range}$	SOT-89 SOT-23FL		0.4	1.2		0.4	1.2		0.4	1.2	$\mu\text{A}$
			SOT-23		0.8	2.0		0.8	2.0		0.8	2.0	$\mu\text{A}$
$I_{KA(MIN)}$	Minimum Cathode Current for Regulation	$V_{KA} = V_{REF}$		0.45	1.00		0.45	1.00		0.45	1.00	mA	
$I_{KA(OFF)}$	Off -Stage Cathode Current	$V_{KA} = 36\text{ V}, V_{REF} = 0$		0.05	1.00		0.05	1.00		0.05	1.00	$\mu\text{A}$	
$Z_{KA}$	Dynamic Impedance	$V_{KA} = V_{REF}, I_{KA} = 1\text{ to }100\text{ mA}, f \geq 1.0\text{ kHz}$		0.15	0.50		0.15	0.50		0.15	0.50	$\Omega$	

Product parametric performance is indicated in the Electrical Characteristics for the listed test conditions, unless otherwise noted. Product performance may not be indicated by the Electrical Characteristics if operated under different conditions.

6. LM431SAI, LM431SBI, LM431SCI:  $-T_{A(min)} = -40^\circ\text{C}, T_{A(max)} = +85^\circ\text{C}$

All other pins:  $-T_{A(min)} = -25^\circ\text{C}, T_{A(max)} = +85^\circ\text{C}$

# LM431SA, LM431SB, LM431SC

## ELECTRICAL CHARACTERISTICS (Continued) (Notes 7 and 8, Values are at $T_A = 25^\circ\text{C}$ unless otherwise noted)

Symbol	Parameter	Conditions	LM431SAI			LM431SBI			LM431SCI			Unit
			Min.	Typ.	Max.	Min.	Typ.	Max.	Min.	Typ.	Max.	
$V_{REF}$	Reference Input Voltage	$V_{KA} = V_{REF}$ $I_{KA} = 10\text{ mA}$	2.450	2.500	2.550	2.470	2.495	2.520	2.482	2.495	2.508	V
$V_{REF(dev)}$	Deviation of Reference Input Voltage Over-Temperature	$V_{KA} = V_{REF}$ $I_{KA} = 10\text{ mA}$ , $T_{MIN} \leq T_A \leq T_{MAX}$		5	20		5	20		5	20	mV
$\frac{\Delta V_{REF}}{\Delta V_{KA}}$	Ratio of Change in Reference Input Voltage to Change in Cathode Voltage	$I_{KA} = 10\text{ mA}$	$\Delta V_{KA} = 10\text{ V} - V_{REF}$	-1.0	-2.7		-1.0	-2.7		-1.0	-2.7	mV/V
			$\Delta V_{KA} = 36\text{ V} - 10\text{ V}$	-0.5	-2.0		-0.5	-2.0		-0.5	-2.0	
$I_{REF}$	Reference Input Current	$I_{KA} = 10\text{ mA}$ , $R_1 = 10\text{ K}\Omega$ , $R_2 = \infty$		1.5	4.0		1.5	4.0		1.5	4.0	$\mu\text{A}$
$I_{REF(dev)}$	Deviation of Reference Input Current Over Full Temperature Range	$I_{KA} = 10\text{ mA}$ , $R_1 = 10\text{ K}\Omega$ , $R_2 = \infty$ , $T_{MIN} \leq T_A \leq T_{MAX}$		0.8	2.0		0.8	2.0		0.8	2.0	$\mu\text{A}$
$I_{KA(MIN)}$	Minimum Cathode Current for Regulation	$V_{KA} = V_{REF}$		0.45	1.00		0.45	1.00		0.45	1.00	mA
$I_{KA(OFF)}$	Off-Stage Cathode Current	$V_{KA} = 36\text{ V}$ , $V_{REF} = 0$		0.05	1.00		0.05	1.00		0.05	1.00	$\mu\text{A}$
ZKA	Dynamic Impedance	$V_{KA} = V_{REF}$ $I_{KA} = 1\text{ to }100\text{ mA}$ , $f \geq 1.0\text{ kHz}$		0.15	0.50		0.15	0.50		0.15	0.50	$\Omega$

7. LM431SAI, LM431SBI, LM431SCI:  $-T_{A(min)} = -40^\circ\text{C}$ ,  $T_{A(max)} = +85^\circ\text{C}$

All other pins:  $-T_{A(min)} = -25^\circ\text{C}$ ,  $T_{A(max)} = +85^\circ\text{C}$

8. The deviation parameters  $V_{REF(dev)}$  and  $I_{REF(dev)}$  are defined as the differences between the maximum and minimum values obtained over the rated temperature range. The average full-range temperature coefficient of the reference input voltage,  $\alpha V_{REF}$ , is defined as:

$$|\alpha V_{REF}| \left( \frac{\text{ppm}}{^\circ\text{C}} \right) = \frac{\left( \frac{V_{REF(dev)}}{V_{REF(at\ 25^\circ\text{C})}} \right) \cdot 10^6}{T_{MAX} - T_{MIN}}$$

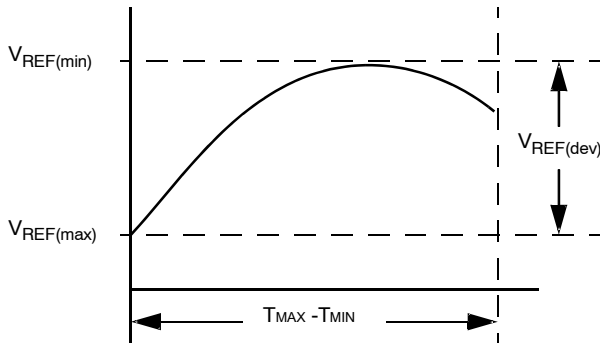

where  $T_{MAX} - T_{MIN}$  is the rated operating free-air temperature range of the device.

$\alpha V_{REF}$  can be positive or negative, depending on whether minimum  $V_{REF}$  or maximum  $V_{REF}$ , respectively, occurs at the lower temperature.

Example:

$V_{REF(dev)} = 4.5\text{ mV}$ ,  $V_{REF} = 2500\text{ mV}$  at  $25^\circ\text{C}$ ,

$T_{MAX} - T_{MIN} = 125^\circ\text{C}$  for LM431SAI.

$$|\alpha V_{REF}| = \frac{\left( \frac{4.5\text{ mV}}{2500\text{ mV}} \right) \cdot 10^6}{125^\circ\text{C}} = 14.4\text{ ppm}/^\circ\text{C}$$

Because minimum  $V_{REF}$  occurs at the lower temperature, the coefficient is positive.

# LM431SA, LM431SB, LM431SC

## TEST CIRCUITS

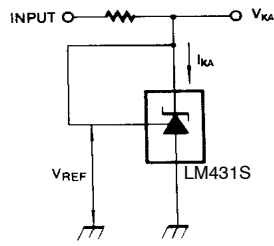

Figure 2. Test Circuit for  $V_{KA} = V_{REF}$

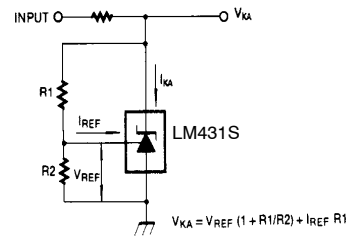

Figure 3. Test Circuit for  $V_{KA} \geq V_{REF}$

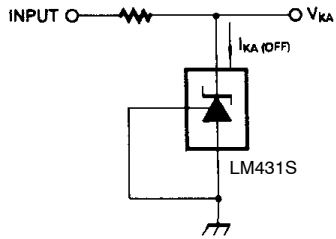

Figure 4. Test Circuit for  $I_{KA(OFF)}$

# LM431SA, LM431SB, LM431SC

## TYPICAL APPLICATIONS

$$V_o = \left(1 + \frac{R_1}{R_2}\right) V_{ref}$$

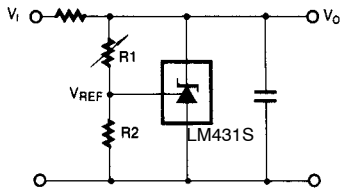

Figure 5. Shunt Regulator

$$V_o = \left(1 + \frac{R_1}{R_2}\right) V_{ref}$$

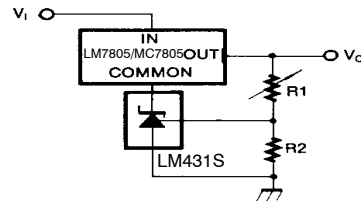

Figure 6. Output Control for Three-Terminal Fixed Regulator

$$V_o = \left(1 + \frac{R_1}{R_2}\right) V_{ref}$$

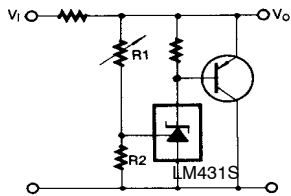

Figure 7. High Current Shunt Regulator

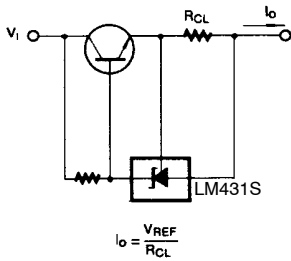

Figure 8. Current Limit or Current Source

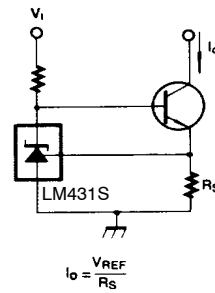

Figure 9. Constant-Current Sink

# LM431SA, LM431SB, LM431SC

## TYPICAL PERFORMANCE CHARACTERISTICS

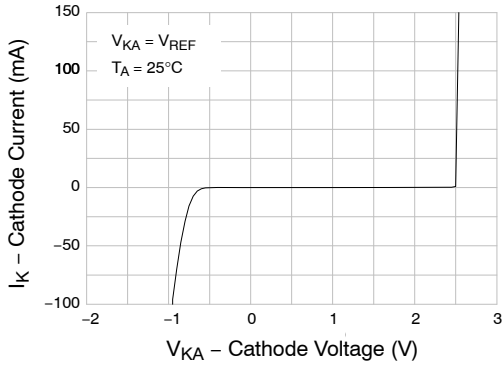

Figure 10. Cathode Current vs. Cathode Voltage

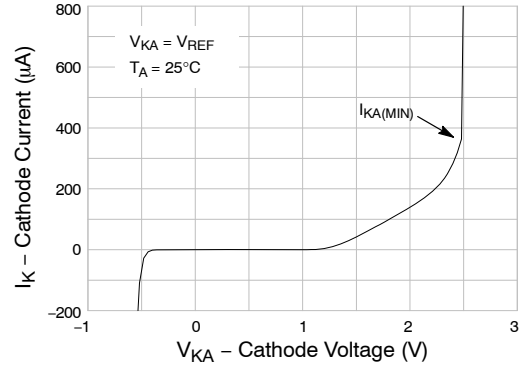

Figure 11. Cathode Current vs. Cathode Voltage

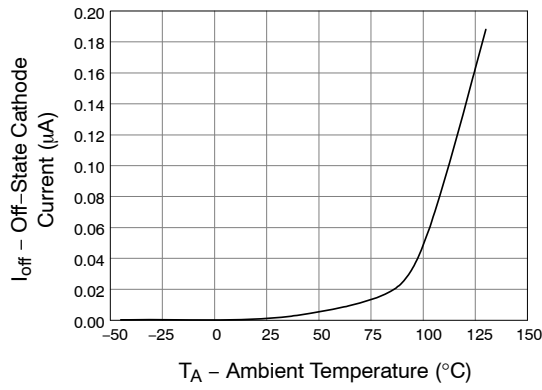

Figure 12. OFF-State Cathode Current vs. Ambient Temperature

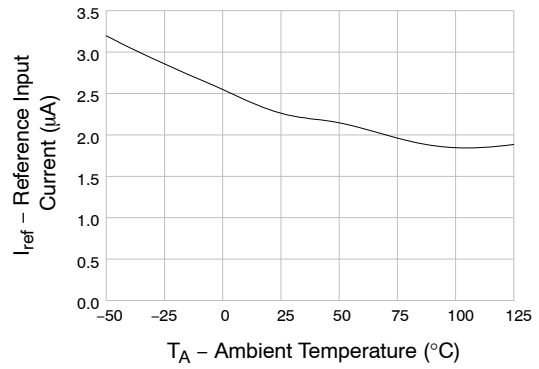

Figure 13. Reference Input Current vs. Ambient Temperature

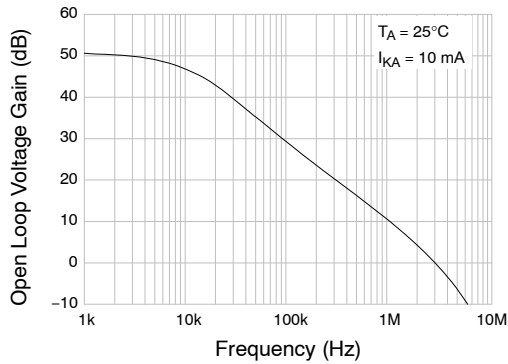

Figure 14. Frequency vs. Small Signal Voltage Amplification

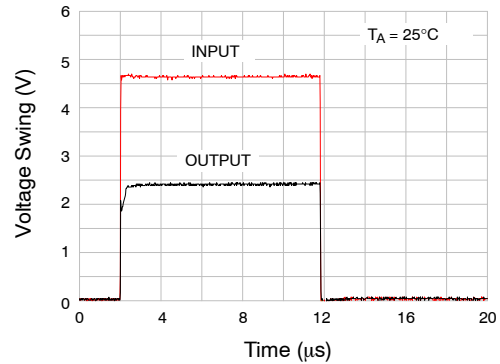

Figure 15. Pulse Response

# LM431SA, LM431SB, LM431SC

## TYPICAL PERFORMANCE CHARACTERISTICS

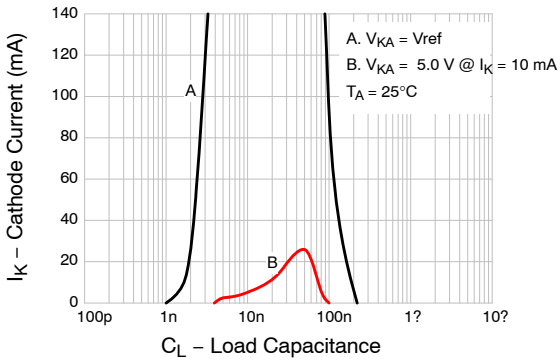

Figure 16. Stability Boundary Conditions

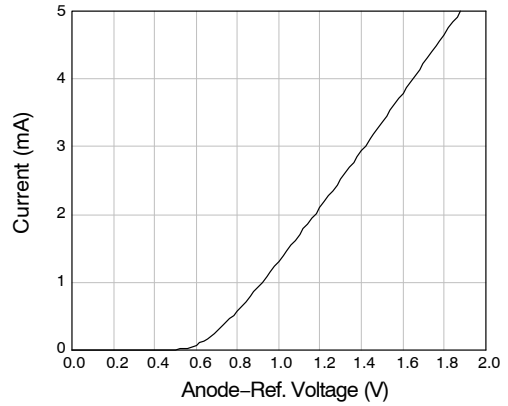

Figure 17. Anode-Reference Diode Curve

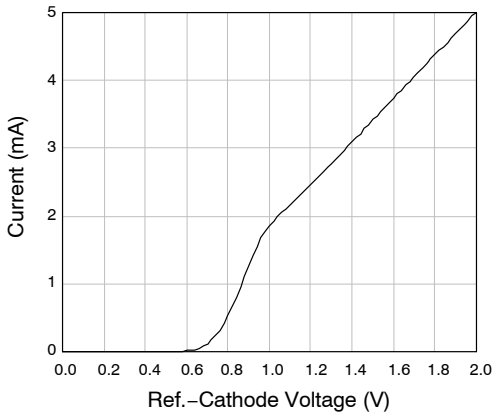

Figure 18. Reference-Cathode Diode Curve

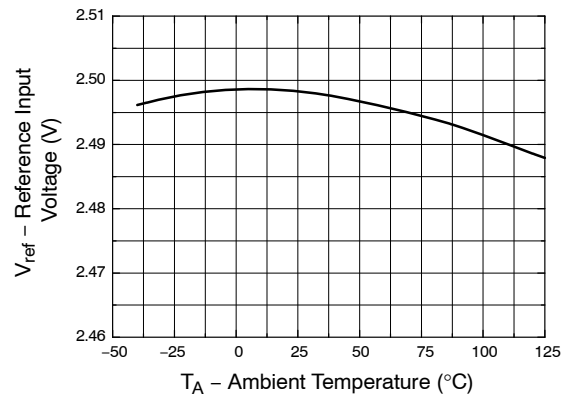
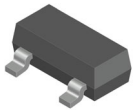

Figure 19. Reference Input Voltage vs. Ambient Temperature



# MECHANICAL CASE OUTLINE PACKAGE DIMENSIONS



**SOT23-3L**  
**CASE 318AB**  
**ISSUE A**

DATE 14 DEC 2021

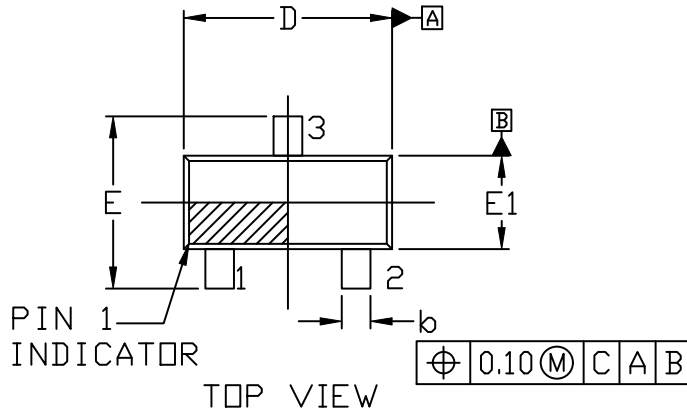

- NOTES:
1. DIMENSIONING AND TOLERANCING PER ASME Y14.5M, 2009.
  2. CONTROLLING DIMENSION: MILLIMETERS
  3. DIMENSION **b** DOES NOT INCLUDE DAMBAR PROTRUSION. ALLOWABLE PROTRUSION SHALL BE 0.127 mm IN EXCESS OF MAXIMUM MATERIAL CONDITION.
  4. DIMENSIONS **D** AND **E1** DO NOT INCLUDE MOLD FLASH, PROTRUSIONS, OR GATE BURRS. MOLD FLASH, PROTRUSIONS, OR GATE BURRS SHALL NOT EXCEED 0.15 mm PER SIDE. DIMENSIONS **D** AND **E1** ARE DETERMINED AT DATUM **F**.
  5. DATUMS **A** AND **B** ARE TO BE DETERMINED AT DATUM **F**.
  6. **A1** IS DEFINED AS THE VERTICAL DISTANCE FROM THE SEATING PLANE TO THE LOWEST POINT ON THE PACKAGE BODY.
  7. LEAD THICKNESS (**c**) AND LEAD WIDTH (**b**) INCLUDE PLATING THICKNESS.

DIM	MILLIMETERS		
	MIN.	NOM.	MAX.
A	---	---	1.15
A1	0.00	---	0.10
A2	0.90	1.00	1.10
b	0.30	---	0.50
c	0.127 REF		
D	2.80	2.90	3.00
E	2.25	2.40	2.55
E1	1.20	1.30	1.40
e	1.90 BSC		
L	0.30	---	---
L1	0.55 REF		
L2	0.25 REF		
M	0°	---	8°

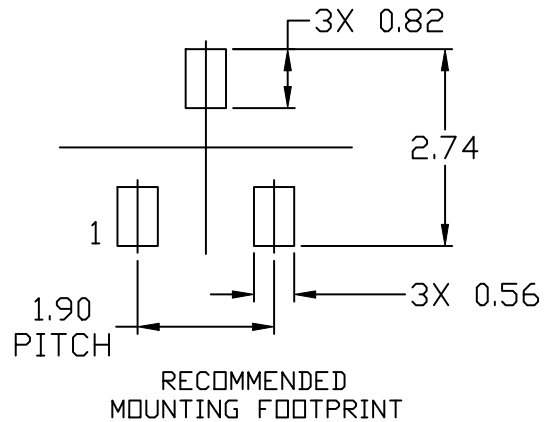
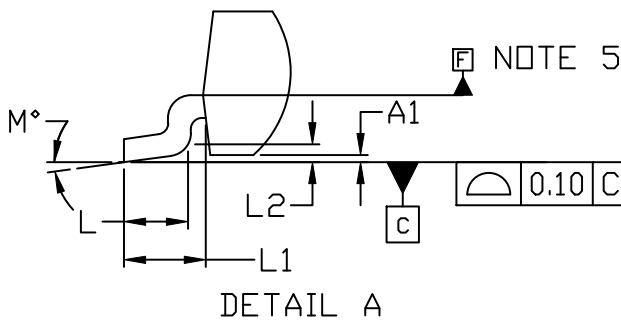
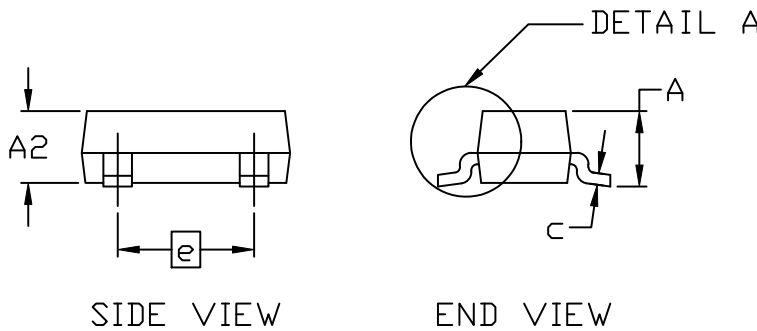

\* For additional information on our Pb-Free strategy and soldering details, please download the ON Semiconductor Soldering and Mounting Techniques Reference Manual, SOLDERM/D.

**GENERIC MARKING DIAGRAM\***

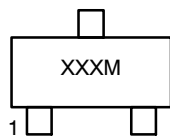

XXX = Specific Device Code  
M = Date Code

\*This information is generic. Please refer to device data sheet for actual part marking. Pb-Free indicator, "G" or microdot "•", may or may not be present. Some products may not follow the Generic Marking.

<b>DOCUMENT NUMBER:</b>	<b>98AON27911H</b>	Electronic versions are uncontrolled except when accessed directly from the Document Repository. Printed versions are uncontrolled except when stamped "CONTROLLED COPY" in red.
<b>DESCRIPTION:</b>	<b>SOT23-3L</b>	<b>PAGE 1 OF 1</b>

onsemi and ONSEMI are trademarks of Semiconductor Components Industries, LLC dba onsemi or its subsidiaries in the United States and/or other countries. onsemi reserves the right to make changes without further notice to any products herein. onsemi makes no warranty, representation or guarantee regarding the suitability of its products for any particular purpose, nor does onsemi assume any liability arising out of the application or use of any product or circuit, and specifically disclaims any and all liability, including without limitation special, consequential or incidental damages. onsemi does not convey any license under its patent rights nor the rights of others.

# MECHANICAL CASE OUTLINE PACKAGE DIMENSIONS

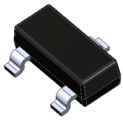

**SOT-23**  
**CASE 318BM**  
**ISSUE A**

DATE 01 SEP 2021

NOTES: UNLESS OTHERWISE SPECIFIED

- A) REFERENCE JEDEC REGISTRATION TO-236, VARIATION AB, ISSUE H.
- B) ALL DIMENSIONS ARE IN MILLIMETERS.
- C) DIMENSIONS ARE INCLUSIVE OF BURRS, MOLD FLASH AND TIE BAR EXTRUSIONS.
- D) DIMENSIONING AND TOLERANCING PER ASME Y14.5M - 2009.

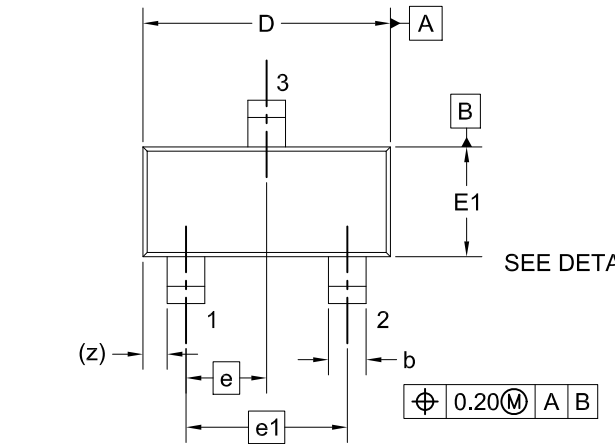

SEE DETAIL A

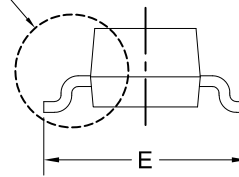

DIM	MILLIMETERS		
	MIN.	NOM.	MAX.
A	---	---	1.20
A1	0.00	0.05	0.10
A2	0.93 REF		
b	0.37	0.44	0.60
c	0.08	0.15	0.23
D	2.72	2.92	3.12
E	2.10	2.40	2.70
E1	1.15	1.30	1.50
e	0.95 BSC		
e1	1.90 BSC		
L	0.20	---	---
L1	0.55 REF		
z	0.29 REF		

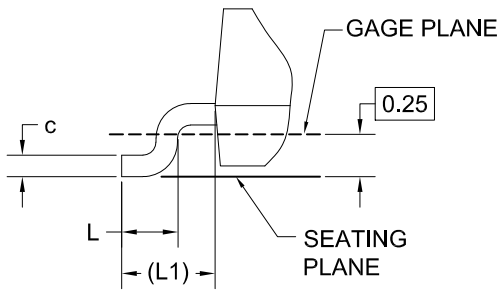
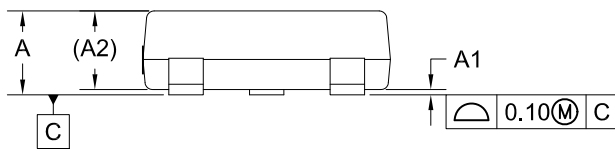

**DETAIL A**  
SCALE: 2X

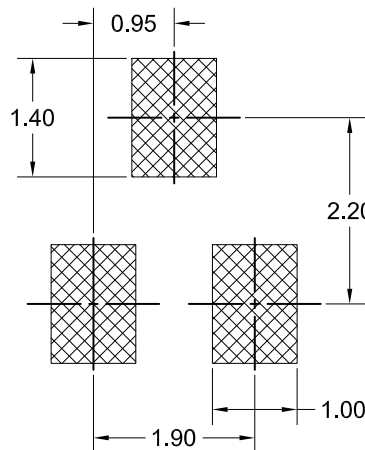

**LAND PATTERN RECOMMENDATION**

### GENERIC MARKING DIAGRAM\*

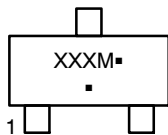

- XXX = Specific Device Code
- M = Date Code
- = Pb-Free Package

\*This information is generic. Please refer to device data sheet for actual part marking. Pb-Free indicator, "G" or microdot "▪", may or may not be present. Some products may not follow the Generic Marking.

\*FOR ADDITIONAL INFORMATION ON OUR PB-FREE STRATEGY AND SOLDERING DETAILS, PLEASE DOWNLOAD THE ON SEMICONDUCTOR SOLDERING AND MOUNTING TECHNIQUES REFERENCE MANUAL, SOLDERRM/D.

<b>DOCUMENT NUMBER:</b>	<b>98AON13784G</b>	Electronic versions are uncontrolled except when accessed directly from the Document Repository. Printed versions are uncontrolled except when stamped "CONTROLLED COPY" in red.
<b>DESCRIPTION:</b>	<b>SOT-23</b>	<b>PAGE 1 OF 1</b>

onsemi and ONSEMI are trademarks of Semiconductor Components Industries, LLC dba onsemi or its subsidiaries in the United States and/or other countries. onsemi reserves the right to make changes without further notice to any products herein. onsemi makes no warranty, representation or guarantee regarding the suitability of its products for any particular purpose, nor does onsemi assume any liability arising out of the application or use of any product or circuit, and specifically disclaims any and all liability, including without limitation special, consequential or incidental damages. onsemi does not convey any license under its patent rights nor the rights of others.



**SOT-89 3 LEAD**  
**CASE 528AH**  
**ISSUE O**

DATE 31 AUG 2016

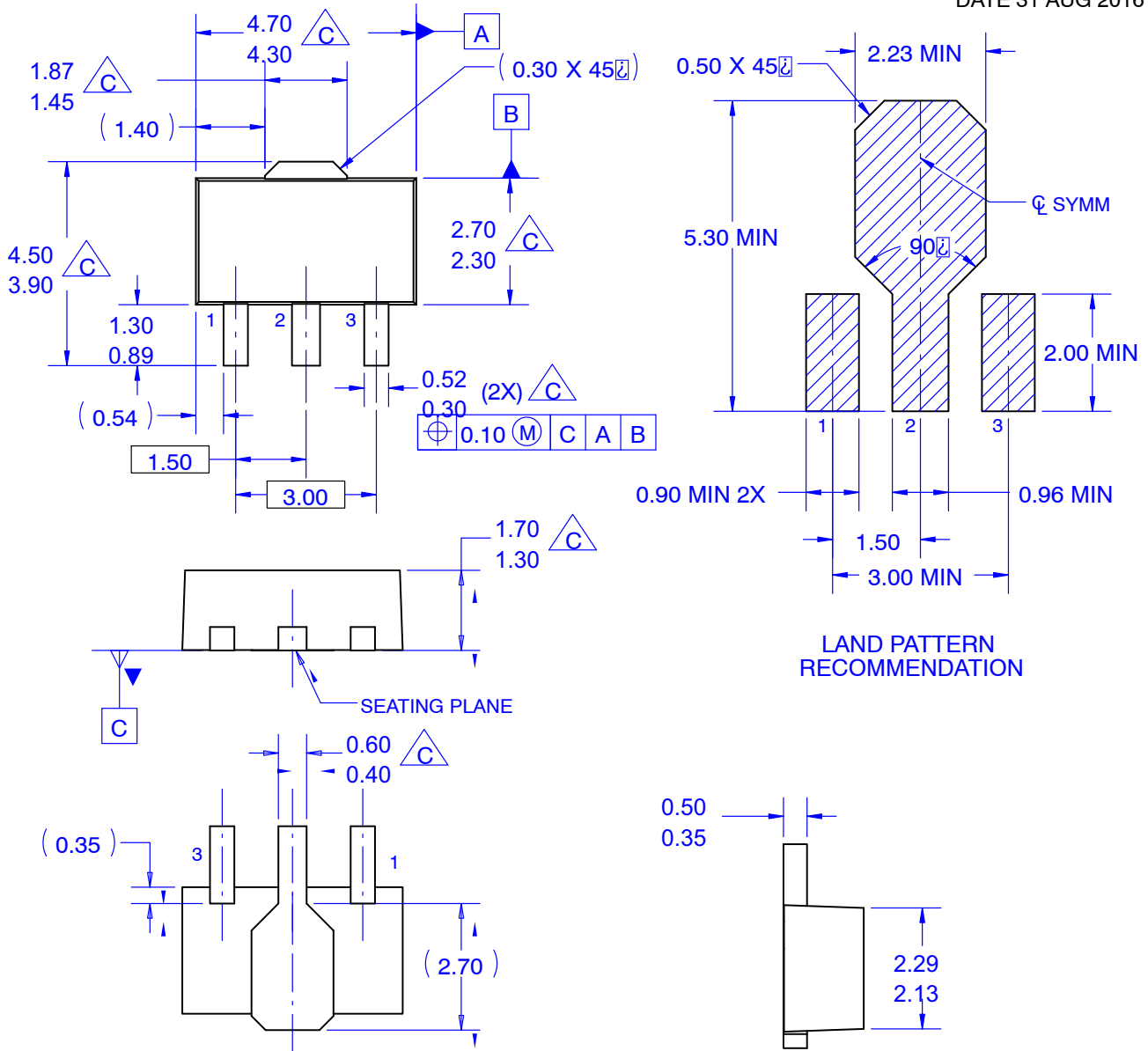

**NOTES: UNLESS OTHERWISE SPECIFIED.**

- A. REFERENCE TO JEDEC TO-243 VARIATION AA.
- B. ALL DIMENSIONS ARE IN MILLIMETERS.
- △ C** DOES NOT COMPLY JEDEC STANDARD VALUE.
- D. DIMENSIONS ARE EXCLUSIVE OF BURRS, MOLD FLASH AND TIE BAR PROTRUSION.
- E. DIMENSION AND TOLERANCE AS PER ASME Y14.5-1994.

<b>DOCUMENT NUMBER:</b>	<b>98AON13791G</b>	Electronic versions are uncontrolled except when accessed directly from the Document Repository. Printed versions are uncontrolled except when stamped "CONTROLLED COPY" in red.
<b>DESCRIPTION:</b>	<b>SOT-89 3 LEAD</b>	<b>PAGE 1 OF 1</b>

ON Semiconductor and are trademarks of Semiconductor Components Industries, LLC dba ON Semiconductor or its subsidiaries in the United States and/or other countries. ON Semiconductor reserves the right to make changes without further notice to any products herein. ON Semiconductor makes no warranty, representation or guarantee regarding the suitability of its products for any particular purpose, nor does ON Semiconductor assume any liability arising out of the application or use of any product or circuit, and specifically disclaims any and all liability, including without limitation special, consequential or incidental damages. ON Semiconductor does not convey any license under its patent rights nor the rights of others.

**onsemi**, **Onsemi**, and other names, marks, and brands are registered and/or common law trademarks of Semiconductor Components Industries, LLC dba "**onsemi**" or its affiliates and/or subsidiaries in the United States and/or other countries. **onsemi** owns the rights to a number of patents, trademarks, copyrights, trade secrets, and other intellectual property. A listing of **onsemi**'s product/patent coverage may be accessed at [www.onsemi.com/site/pdf/Patent-Marking.pdf](http://www.onsemi.com/site/pdf/Patent-Marking.pdf). **onsemi** reserves the right to make changes at any time to any products or information herein, without notice. The information herein is provided "as-is" and **onsemi** makes no warranty, representation or guarantee regarding the accuracy of the information, product features, availability, functionality, or suitability of its products for any particular purpose, nor does **onsemi** assume any liability arising out of the application or use of any product or circuit, and specifically disclaims any and all liability, including without limitation special, consequential or incidental damages. Buyer is responsible for its products and applications using **onsemi** products, including compliance with all laws, regulations and safety requirements or standards, regardless of any support or applications information provided by **onsemi**. "Typical" parameters which may be provided in **onsemi** data sheets and/or specifications can and do vary in different applications and actual performance may vary over time. All operating parameters, including "Typicals" must be validated for each customer application by customer's technical experts. **onsemi** does not convey any license under any of its intellectual property rights nor the rights of others. **onsemi** products are not designed, intended, or authorized for use as a critical component in life support systems or any FDA Class 3 medical devices or medical devices with a same or similar classification in a foreign jurisdiction or any devices intended for implantation in the human body. Should Buyer purchase or use **onsemi** products for any such unintended or unauthorized application, Buyer shall indemnify and hold **onsemi** and its officers, employees, subsidiaries, affiliates, and distributors harmless against all claims, costs, damages, and expenses, and reasonable attorney fees arising out of, directly or indirectly, any claim of personal injury or death associated with such unintended or unauthorized use, even if such claim alleges that **onsemi** was negligent regarding the design or manufacture of the part. **onsemi** is an Equal Opportunity/Affirmative Action Employer. This literature is subject to all applicable copyright laws and is not for resale in any manner.

## PUBLICATION ORDERING INFORMATION

### LITERATURE FULFILLMENT:

Email Requests to: [orderlit@onsemi.com](mailto:orderlit@onsemi.com)

**onsemi Website:** [www.onsemi.com](http://www.onsemi.com)

### TECHNICAL SUPPORT

**North American Technical Support:**  
Voice Mail: 1 800-282-9855 Toll Free USA/Canada  
Phone: 011 421 33 790 2910

**Europe, Middle East and Africa Technical Support:**

Phone: 00421 33 790 2910

For additional information, please contact your local Sales Representative