

LM4562 Dual High-Performance, High-Fidelity Audio Operational Amplifier

Check for Samples: [LM4562](#)

FEATURES

- Easily Drives 600Ω Loads
- Optimized for Superior Audio Signal Fidelity
- Output Short Circuit Protection
- PSRR and CMRR Exceed 120dB (Typ)
- SOIC, PDIP, and TO-99 Packages

APPLICATIONS

- Ultra High-Quality Audio Amplification
- High-Fidelity Preamplifiers
- High-Performance Professional Audio
- High-Fidelity Active Equalization and Crossover Networks
- High-Performance Line Drivers and Receivers

KEY SPECIFICATIONS

- Power Supply Voltage Range: $\pm 2.5\text{V}$ to $\pm 17\text{V}$
- THD+N ($A_V = 1$, $V_{OUT} = 3V_{RMS}$, $f_{IN} = 1\text{kHz}$)
 - $R_L = 2\text{k}\Omega$: 0.00003% (typ)
 - $R_L = 600\Omega$: 0.00003% (typ)
- Input Noise Density: $2.7\text{nV}/\sqrt{\text{Hz}}$ (typ)
- Slew Rate: $\pm 20\text{V}/\mu\text{s}$ (typ)
- Gain Bandwidth Product: 55MHz (typ)
- Open Loop Gain ($R_L = 600\Omega$): 140dB (typ)
- Input Bias Current: 10nA (typ)
- Input Offset Voltage: 0.1mV (typ)
- DC Gain Linearity Error: 0.000009%

DESCRIPTION

The LM4562 is part of the ultra-low distortion, low-noise, high-slew-rate operational amplifier series optimized and fully specified for high-performance, high-fidelity applications. The LM4562 audio operational amplifiers deliver superior audio signal amplification for outstanding audio performance. The LM4562 combines extremely low voltage noise density ($2.7\text{nV}/\sqrt{\text{Hz}}$) with vanishingly low THD+N (0.00003%) to easily satisfy the most demanding audio applications. To ensure that the most challenging loads are driven without compromise, the LM4562 has a high slew rate of $\pm 20\text{V}/\mu\text{s}$ and an output current capability of $\pm 26\text{mA}$. Further, dynamic range is maximized by an output stage that drives $2\text{k}\Omega$ loads to within 1V of either power supply voltage and to within 1.4V when driving 600Ω loads.

The LM4562's outstanding CMRR (120dB), PSRR (120dB), and V_{OS} (0.1mV) give the amplifier excellent operational amplifier DC performance.

The LM4562 has a wide supply range of $\pm 2.5\text{V}$ to $\pm 17\text{V}$. Over this supply range the LM4562's input circuitry maintains excellent common-mode and power supply rejection, as well as maintaining its low input bias current. The LM4562 is unity gain stable. This Audio Operational Amplifier achieves outstanding AC performance while driving complex loads with values as high as 100pF .

The LM4562 is available in an 8-lead narrow body SOIC, an 8-lead PDIP, and an 8-lead TO-99.

TYPICAL APPLICATION

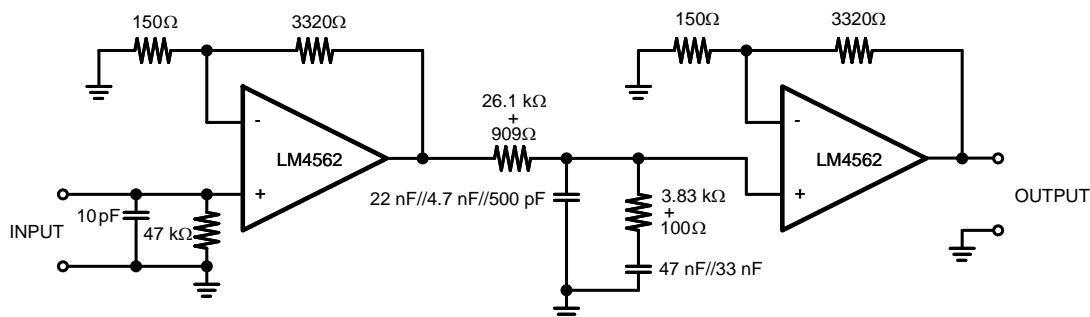

A. 1% metal film resistors, 5% polypropylene capacitors

Passively Equalized RIAA Phono Preamplifier



Please be aware that an important notice concerning availability, standard warranty, and use in critical applications of Texas Instruments semiconductor products and disclaimers thereto appears at the end of this data sheet.

All trademarks are the property of their respective owners.

CONNECTION DIAGRAMS

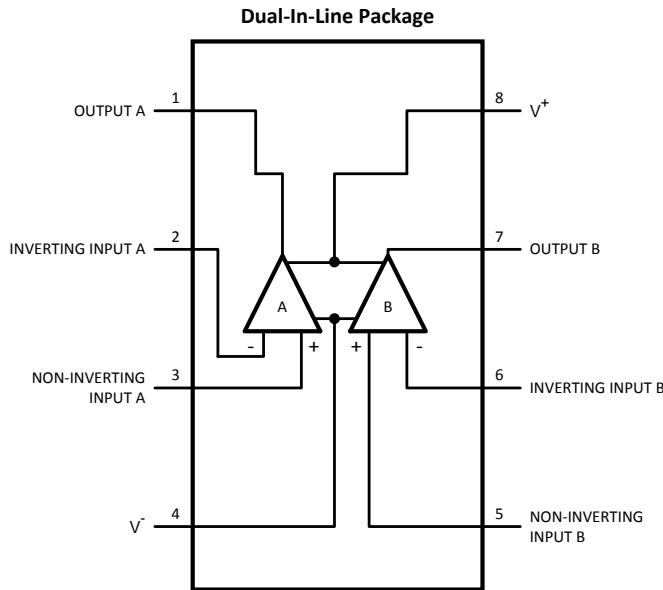

**Figure 1. 8-Lead SOIC (D Package)
8-Lead PDIP (P Package)**

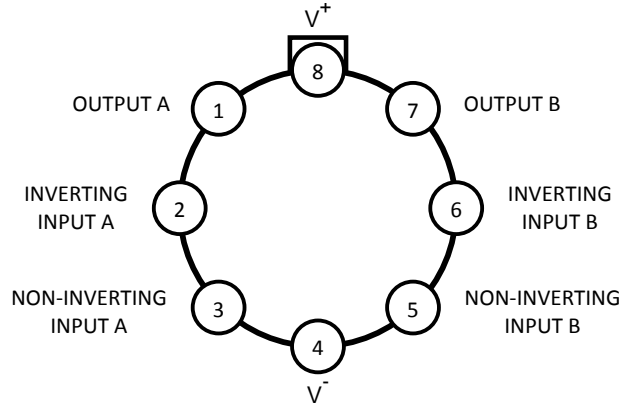

Figure 2. 8-Lead TO-99 (LMC Package)



These devices have limited built-in ESD protection. The leads should be shorted together or the device placed in conductive foam during storage or handling to prevent electrostatic damage to the MOS gates.

ABSOLUTE MAXIMUM RATINGS⁽¹⁾⁽²⁾⁽³⁾

Power Supply Voltage ($V_S = V^+ - V^-$)		36V
Storage Temperature		-65°C to 150°C
Input Voltage		(V-) - 0.7V to (V+) + 0.7V
Output Short Circuit ⁽⁴⁾		Continuous
Power Dissipation		Internally Limited
ESD Susceptibility ⁽⁵⁾		2000V
ESD Susceptibility ⁽⁶⁾	Pins 1, 4, 7 and 8	200V
	Pins 2, 3, 5 and 6	100V
Junction Temperature		150°C
Thermal Resistance	θ_{JA} (D)	145°C/W
	θ_{JA} (P)	102°C/W
	θ_{JA} (LMC)	150°C/W
	θ_{JC} (LMC)	35°C/W
Temperature Range ($T_{MIN} \leq T_A \leq T_{MAX}$)		-40°C \leq T_A \leq 85°C
Supply Voltage Range		$\pm 2.5V \leq V_S \leq \pm 17V$

- (1) Absolute Maximum Ratings indicate limits beyond which damage to the device may occur.
- (2) Operating Ratings indicate conditions for which the device is functional, but do not ensure specific performance limits. For ensured specifications and test conditions, see the Electrical Characteristics. The ensured specifications apply only for the test conditions listed. Some performance characteristics may degrade when the device is not operated under the listed test conditions.
- (3) If Military/Aerospace specified devices are required, please contact the Texas Instruments Sales Office/Distributors for availability and specifications.
- (4) Amplifier output connected to GND, any number of amplifiers within a package.
- (5) Human body model, 100pF discharged through a 1.5k Ω resistor.
- (6) Machine Model ESD test is covered by specification EIAJ IC-121-1981. A 200pF cap is charged to the specified voltage and then discharged directly into the IC with no external series resistor (resistance of discharge path must be under 50 Ω).

ELECTRICAL CHARACTERISTICS FOR THE LM4562⁽¹⁾⁽²⁾

 The specifications apply for $V_S = \pm 15V$, $R_L = 2k\Omega$, $f_{IN} = 1kHz$, $T_A = 25^\circ C$, unless otherwise specified.

Symbol	Parameter	Conditions	LM4562		Units (Limits)
			Typical ⁽³⁾	Limit ⁽⁴⁾	
THD+N	Total Harmonic Distortion + Noise	$A_V = 1$, $V_{OUT} = 3V_{rms}$ $R_L = 2k\Omega$ $R_L = 600\Omega$	0.00003 0.00003	0.00009	% (max)
IMD	Intermodulation Distortion	$A_V = 1$, $V_{OUT} = 3V_{RMS}$ Two-tone, 60Hz & 7kHz 4:1	0.00005		%
GBWP	Gain Bandwidth Product		55	45	MHz (min)
SR	Slew Rate		± 20	± 15	V/ μs (min)
FPBW	Full Power Bandwidth	$V_{OUT} = 1V_{P-P}$, $-3dB$ referenced to output magnitude at $f = 1kHz$	10		MHz
t_s	Settling time	$A_V = -1$, 10V step, $C_L = 100pF$ 0.1% error range	1.2		μs
e_n	Equivalent Input Noise Voltage	$f_{BW} = 20Hz$ to $20kHz$	0.34	0.65	μV_{RMS} (max)
	Equivalent Input Noise Density	$f = 1kHz$ $f = 10Hz$	2.7 6.4	4.7	nV/\sqrt{Hz} (max)
i_n	Current Noise Density	$f = 1kHz$ $f = 10Hz$	1.6 3.1		pA/\sqrt{Hz}
V_{OS}	Offset Voltage		± 0.1	± 0.7	mV (max)
$\Delta V_{OS}/\Delta Temp$	Average Input Offset Voltage Drift vs Temperature	$-40^\circ C \leq T_A \leq 85^\circ C$	0.2		$\mu V/^\circ C$
PSRR	Average Input Offset Voltage Shift vs Power Supply Voltage	$\Delta V_S = 20V^{(5)}$	120	110	dB (min)
ISO _{CH-CH}	Channel-to-Channel Isolation	$f_{IN} = 1kHz$ $f_{IN} = 20kHz$	118 112		dB
I_B	Input Bias Current	$V_{CM} = 0V$	10	72	nA (max)
$\Delta I_{OS}/\Delta Temp$	Input Bias Current Drift vs Temperature	$-40^\circ C \leq T_A \leq 85^\circ C$	0.1		nA/ $^\circ C$
I_{OS}	Input Offset Current	$V_{CM} = 0V$	11	65	nA (max)
V_{IN-CM}	Common-Mode Input Voltage Range		+14.1 -13.9	(V+) - 2.0 (V-) + 2.0	V (min)
CMRR	Common-Mode Rejection	$-10V < V_{cm} < 10V$	120	110	dB (min)
Z_{IN}	Differential Input Impedance		30		k Ω
	Common Mode Input Impedance	$-10V < V_{cm} < 10V$	1000		M Ω
A_{VOL}	Open Loop Voltage Gain	$-10V < V_{out} < 10V$, $R_L = 600\Omega$	140	125	dB (min)
		$-10V < V_{out} < 10V$, $R_L = 2k\Omega$	140		
		$-10V < V_{out} < 10V$, $R_L = 10k\Omega$	140		
V_{OUTMAX}	Maximum Output Voltage Swing	$R_L = 600\Omega$	± 13.6	± 12.5	V (min)
		$R_L = 2k\Omega$	± 14.0		
		$R_L = 10k\Omega$	± 14.1		
I_{OUT}	Output Current	$R_L = 600\Omega$, $V_S = \pm 17V$	± 26	± 23	mA (min)
I_{OUT-CC}	Instantaneous Short Circuit Current		+53 -42		mA
R_{OUT}	Output Impedance	$f_{IN} = 10kHz$ Closed-Loop Open-Loop	0.01 13		Ω

(1) Absolute Maximum Ratings indicate limits beyond which damage to the device may occur.

(2) Operating Ratings indicate conditions for which the device is functional, but do not ensure specific performance limits. For ensured specifications and test conditions, see the Electrical Characteristics. The ensured specifications apply only for the test conditions listed. Some performance characteristics may degrade when the device is not operated under the listed test conditions.

 (3) Typical specifications are specified at $+25^\circ C$ and represent the most likely parametric norm.

(4) Tested limits are specified to AOQL (Average Outgoing Quality Level).

 (5) PSRR is measured as follows: V_{OS} is measured at two supply voltages, $\pm 5V$ and $\pm 15V$. $PSRR = |20\log(\Delta V_{OS}/\Delta V_S)|$.

ELECTRICAL CHARACTERISTICS FOR THE LM4562⁽¹⁾⁽²⁾ (continued)

The specifications apply for $V_S = \pm 15V$, $R_L = 2k\Omega$, $f_{IN} = 1kHz$, $T_A = 25^\circ C$, unless otherwise specified.

Symbol	Parameter	Conditions	LM4562		Units (Limits)
			Typical ⁽³⁾	Limit ⁽⁴⁾	
C_{LOAD}	Capacitive Load Drive Overshoot	100pF	16		%
I_S	Total Quiescent Current	$I_{OUT} = 0mA$	10	12	mA (max)

TYPICAL PERFORMANCE CHARACTERISTICS

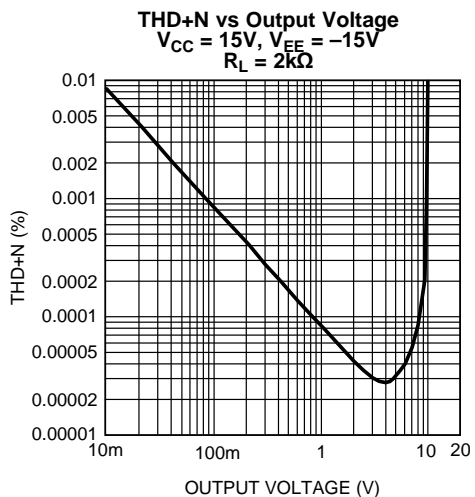

Figure 3.

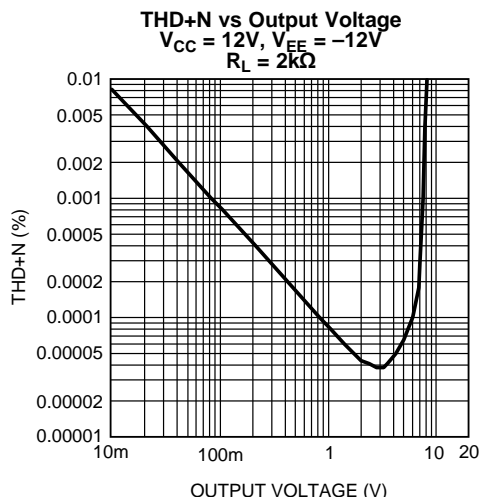

Figure 4.

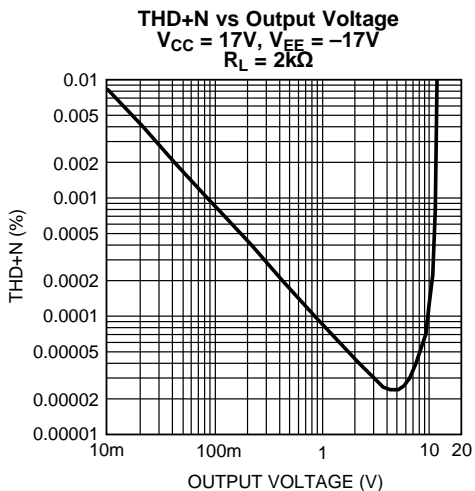

Figure 5.

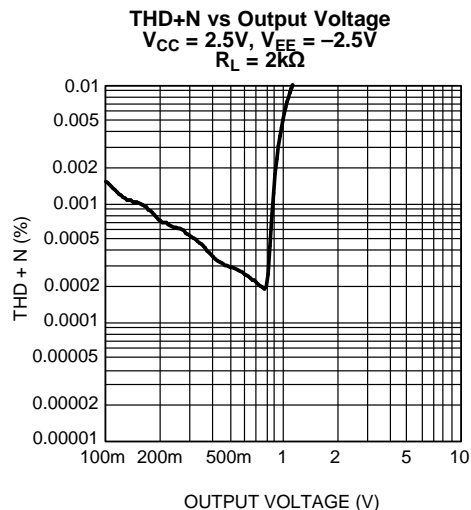

Figure 6.

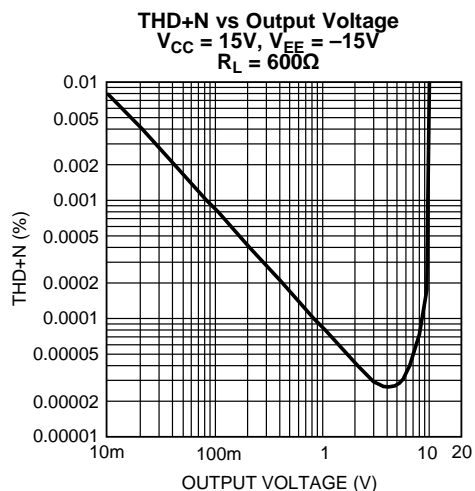

Figure 7.

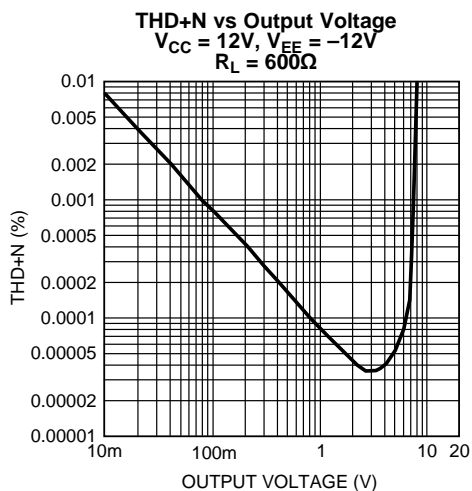

Figure 8.

TYPICAL PERFORMANCE CHARACTERISTICS (continued)

THD+N vs Output Voltage
 $V_{CC} = 17V, V_{EE} = -17V$
 $R_L = 600\Omega$

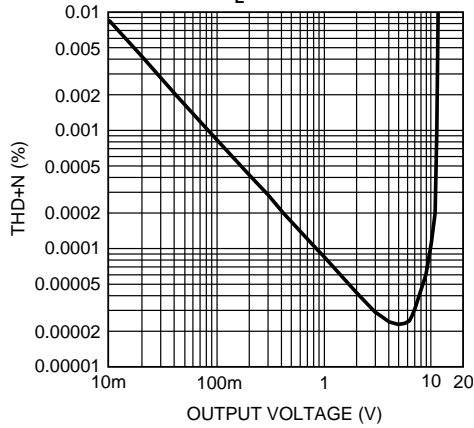

Figure 9.

THD+N vs Output Voltage
 $V_{CC} = 2.5V, V_{EE} = -2.5V$
 $R_L = 600\Omega$

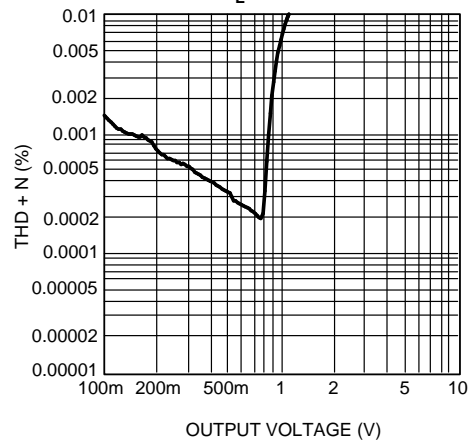

Figure 10.

THD+N vs Output Voltage
 $V_{CC} = 15V, V_{EE} = -15V$
 $R_L = 10k\Omega$

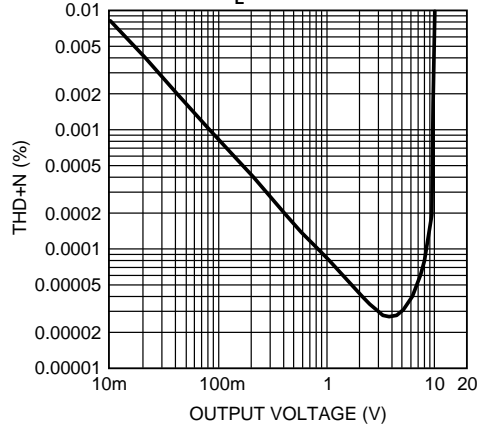

Figure 11.

THD+N vs Output Voltage
 $V_{CC} = 12V, V_{EE} = -12V$
 $R_L = 10k\Omega$

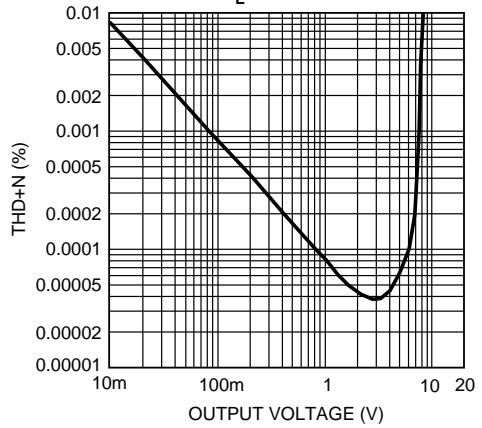

Figure 12.

THD+N vs Output Voltage
 $V_{CC} = 17V, V_{EE} = -17V$
 $R_L = 10k\Omega$

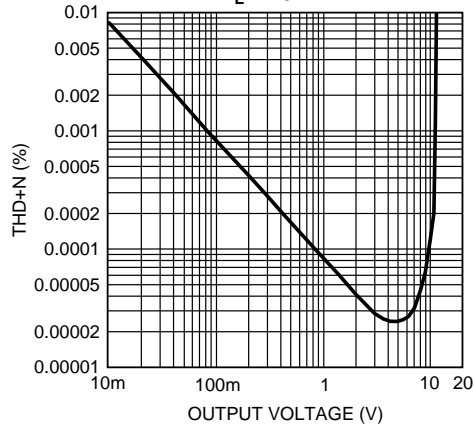

Figure 13.

THD+N vs Output Voltage
 $V_{CC} = 2.5V, V_{EE} = -2.5V$
 $R_L = 10k\Omega$

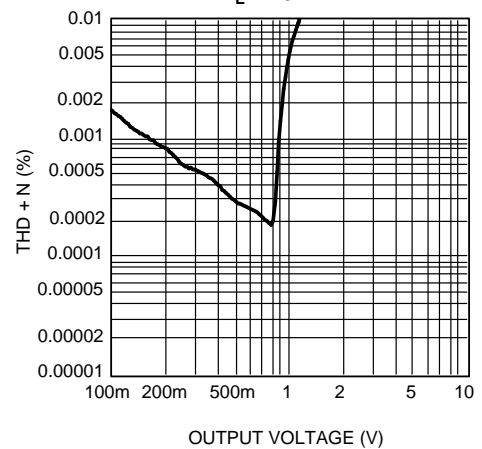

Figure 14.

TYPICAL PERFORMANCE CHARACTERISTICS (continued)

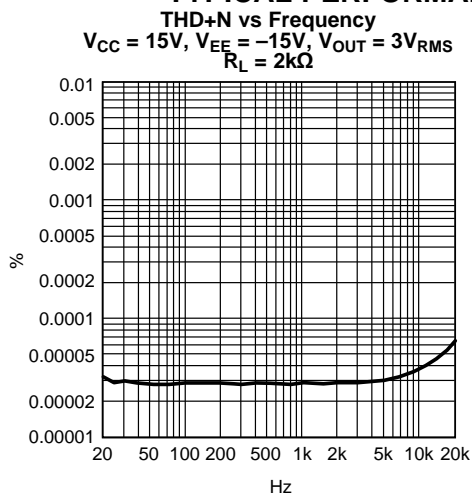

Figure 15.

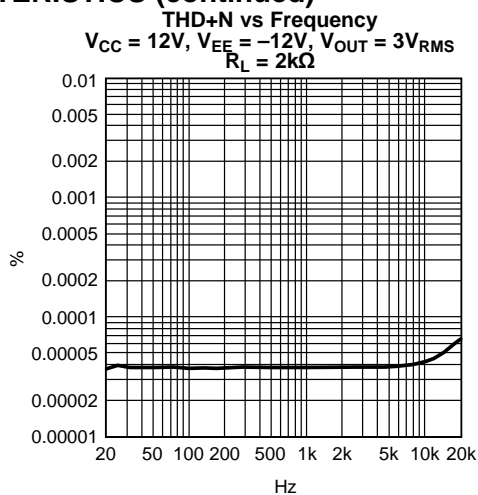

Figure 16.

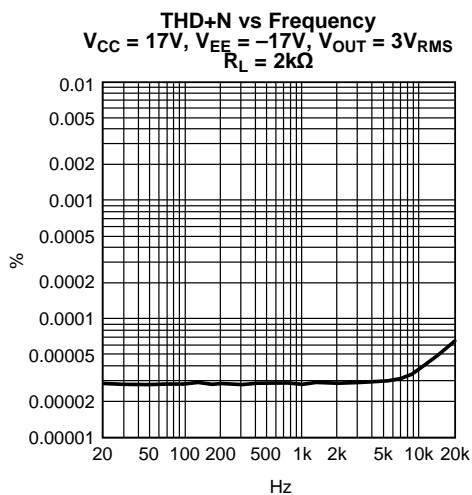

Figure 17.

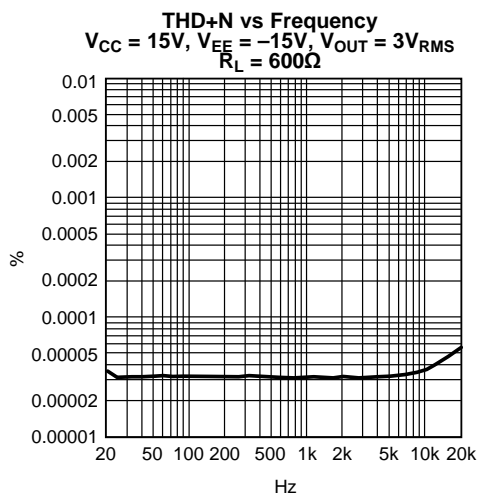

Figure 18.

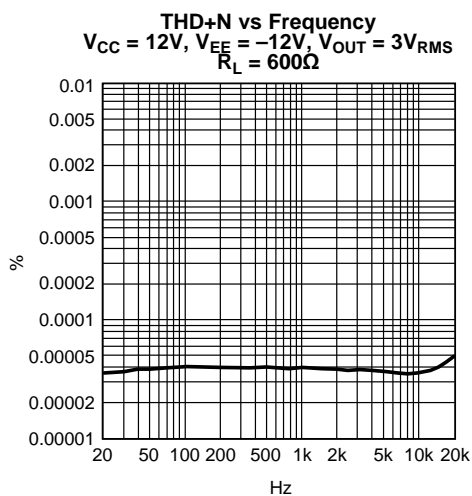

Figure 19.

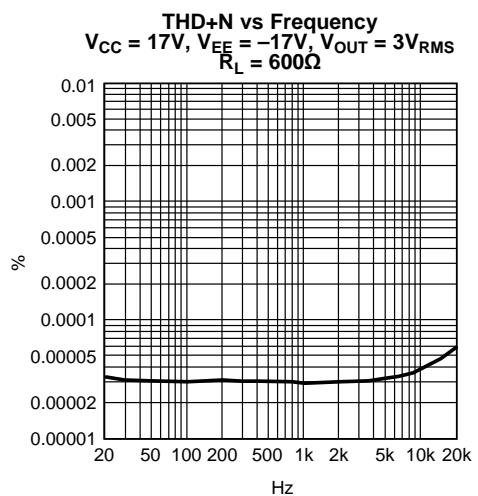
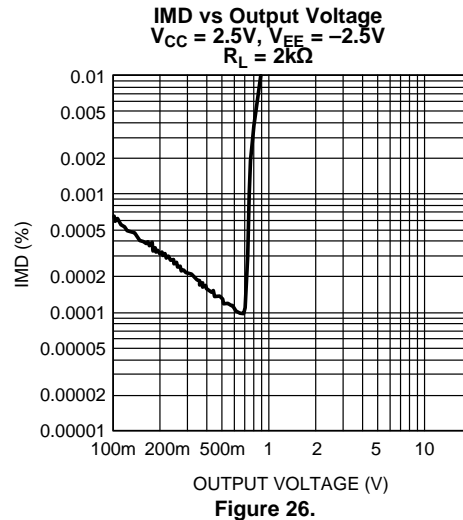
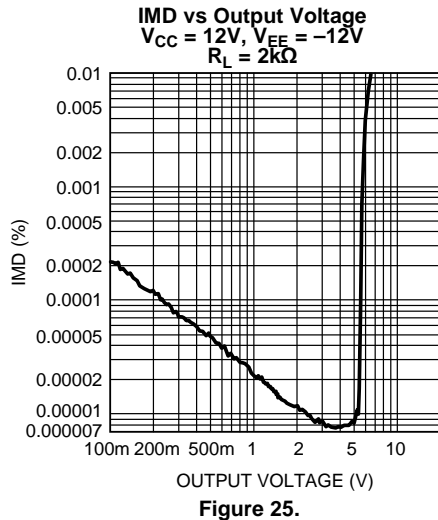
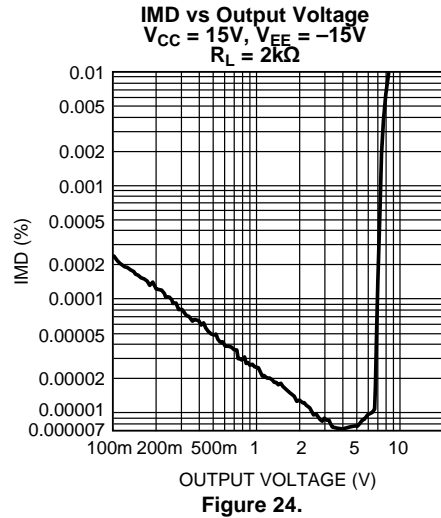
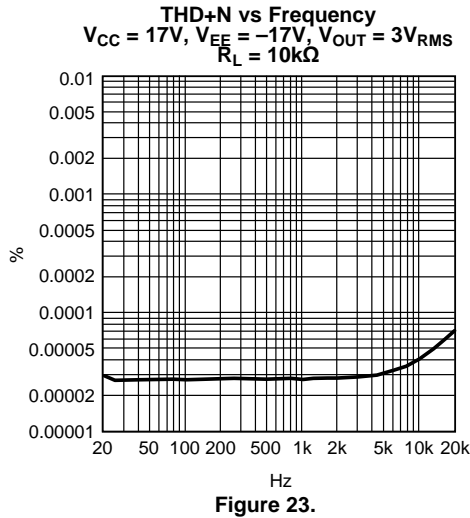
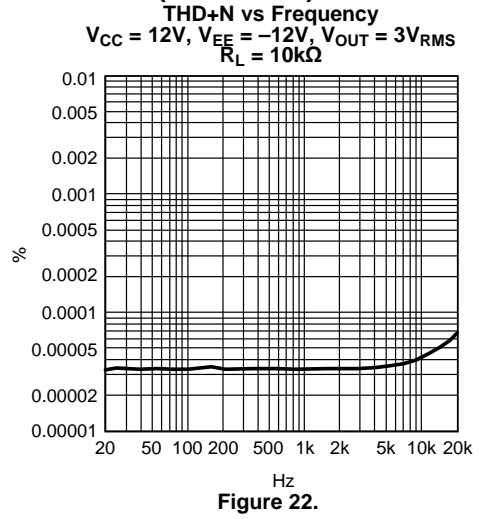
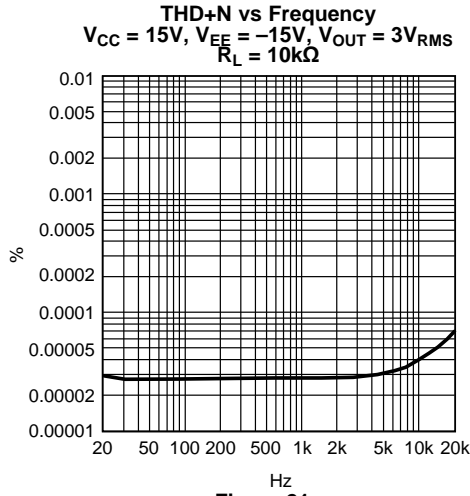

Figure 20.

TYPICAL PERFORMANCE CHARACTERISTICS (continued)



TYPICAL PERFORMANCE CHARACTERISTICS (continued)

IMD vs Output Voltage
 $V_{CC} = 17V, V_{EE} = -17V$
 $R_L = 2k\Omega$

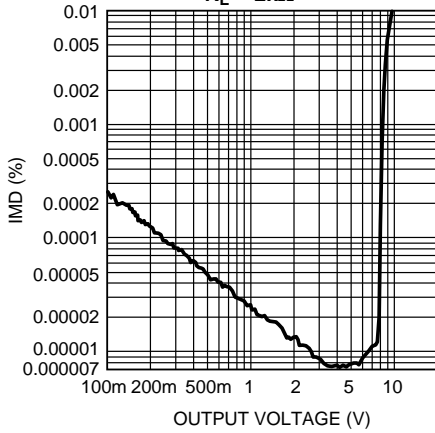

Figure 27.

IMD vs Output Voltage
 $V_{CC} = 15V, V_{EE} = -15V$
 $R_L = 600\Omega$

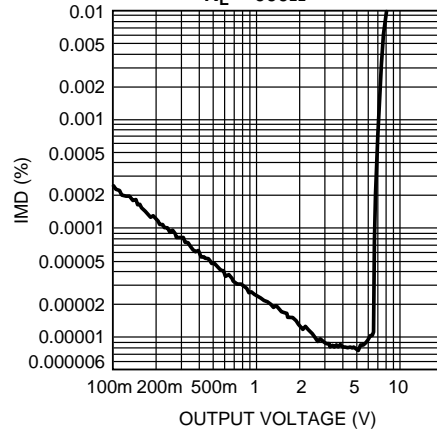

Figure 28.

IMD vs Output Voltage
 $V_{CC} = 12V, V_{EE} = -12V$
 $R_L = 600\Omega$

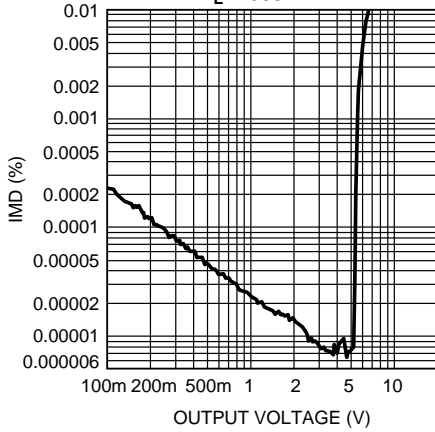

Figure 29.

IMD vs Output Voltage
 $V_{CC} = 17V, V_{EE} = -17V$
 $R_L = 600\Omega$

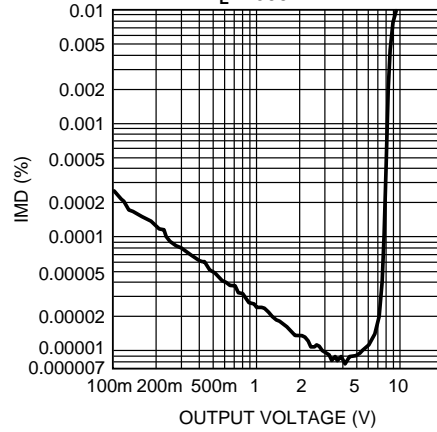

Figure 30.

IMD vs Output Voltage
 $V_{CC} = 2.5V, V_{EE} = -2.5V$
 $R_L = 600\Omega$

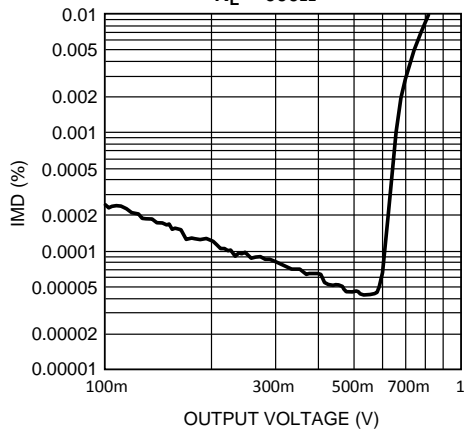

Figure 31.

IMD vs Output Voltage
 $V_{CC} = 15V, V_{EE} = -15V$
 $R_L = 10k\Omega$

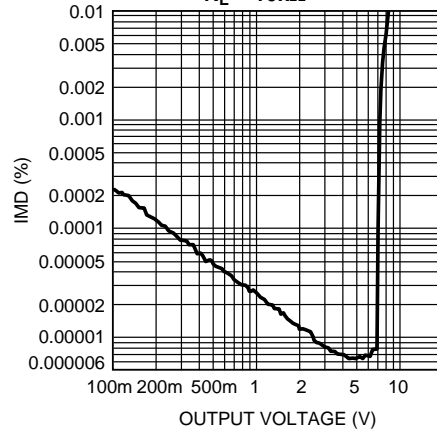

Figure 32.

TYPICAL PERFORMANCE CHARACTERISTICS (continued)

IMD vs Output Voltage
 $V_{CC} = 12V, V_{EE} = -12V$
 $R_L = 10k\Omega$

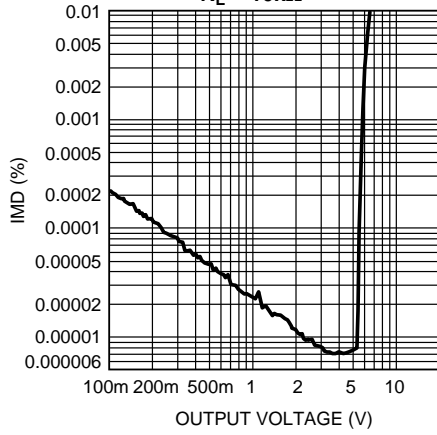

Figure 33.

IMD vs Output Voltage
 $V_{CC} = 17V, V_{EE} = -17V$
 $R_L = 10k\Omega$

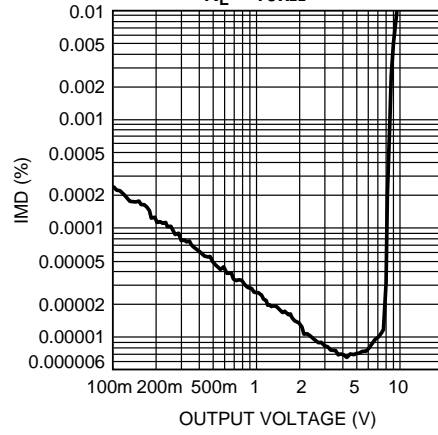

Figure 34.

IMD vs Output Voltage
 $V_{CC} = 2.5V, V_{EE} = -2.5V$
 $R_L = 10k\Omega$

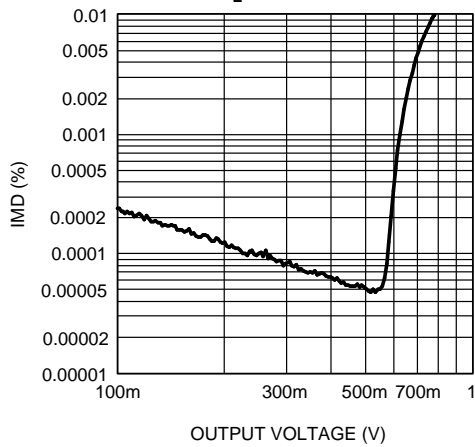

Figure 35.

Voltage Noise Density vs Frequency

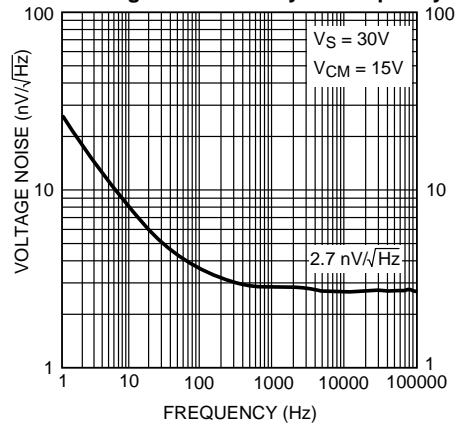

Figure 36.

Current Noise Density vs Frequency

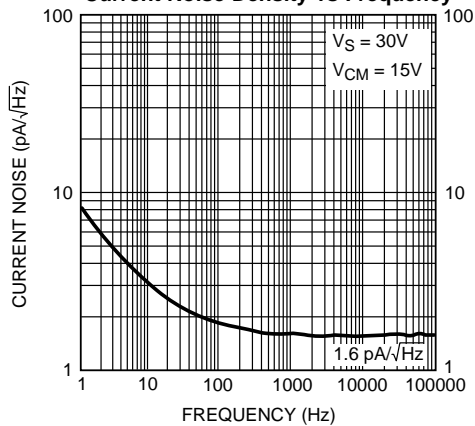

Figure 37.

Crosstalk vs Frequency
 $V_{CC} = 15V, V_{EE} = -15V, V_{OUT} = 3V_{RMS}$
 $A_V = 0dB, R_L = 2k\Omega$

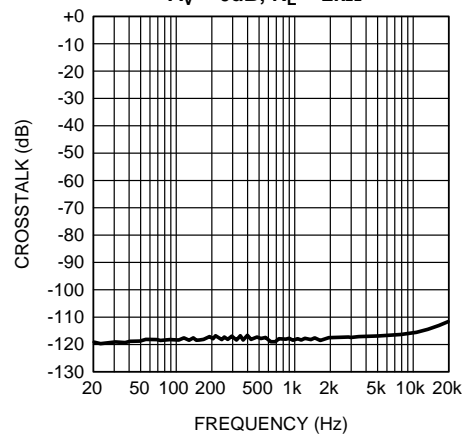

Figure 38.

TYPICAL PERFORMANCE CHARACTERISTICS (continued)

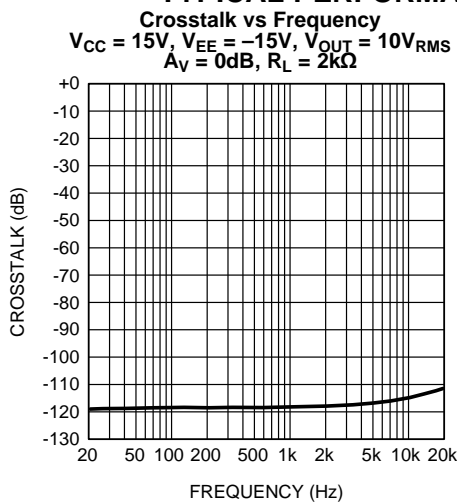

Figure 39.

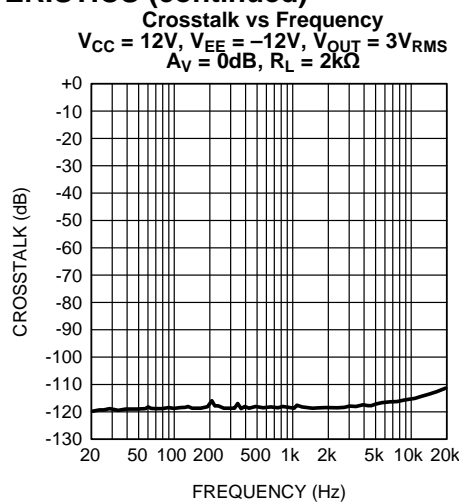

Figure 40.

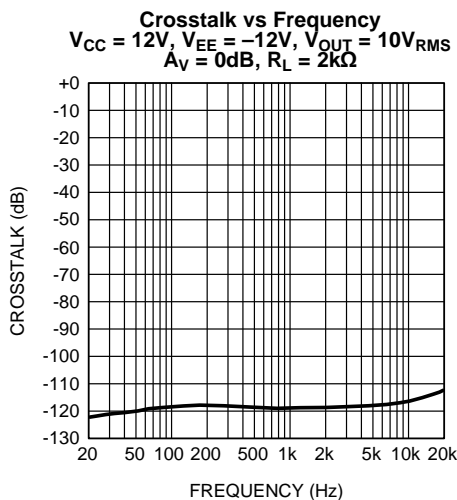

Figure 41.

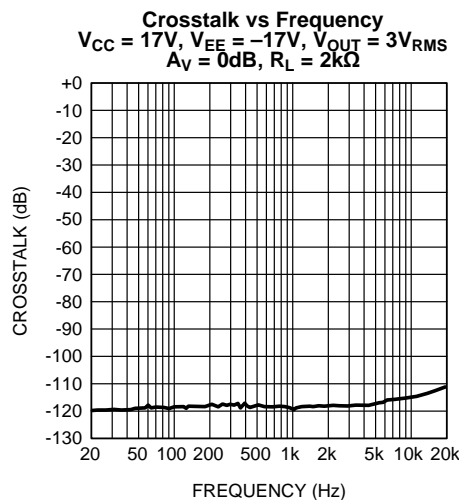

Figure 42.

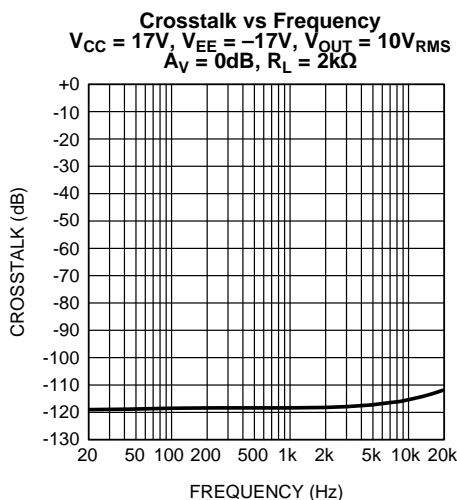

Figure 43.

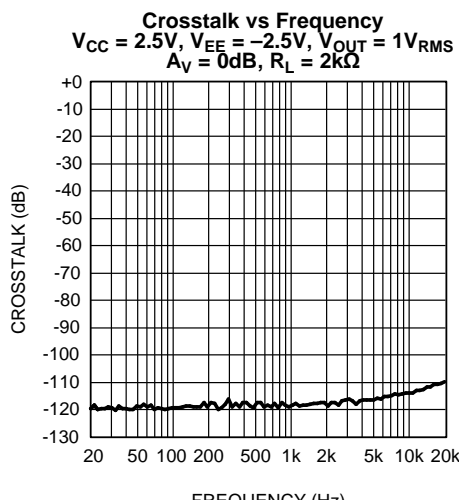

Figure 44.

TYPICAL PERFORMANCE CHARACTERISTICS (continued)

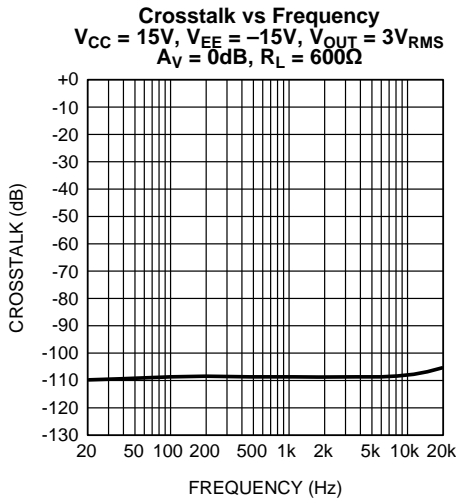

Figure 45.

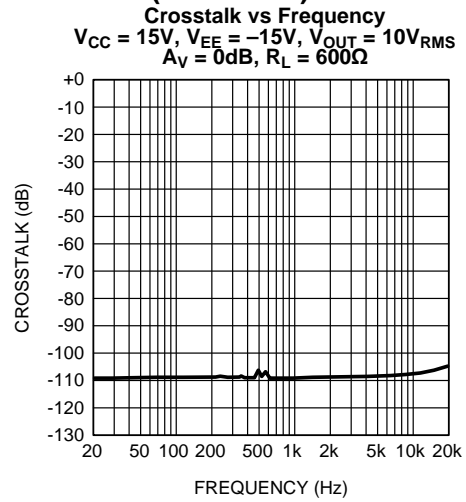

Figure 46.

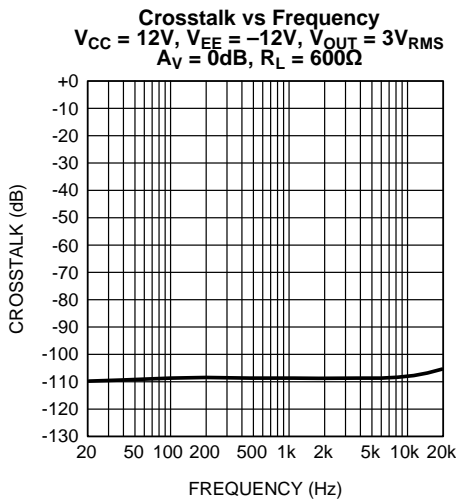

Figure 47.

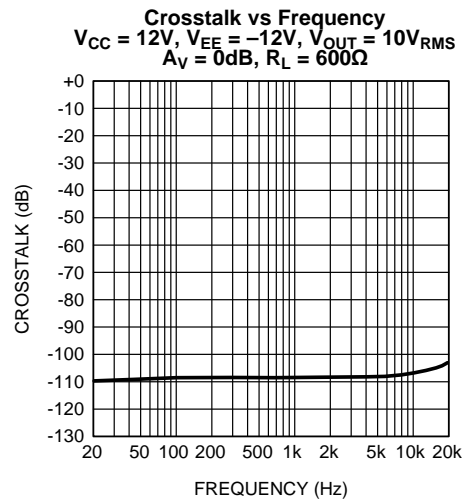

Figure 48.

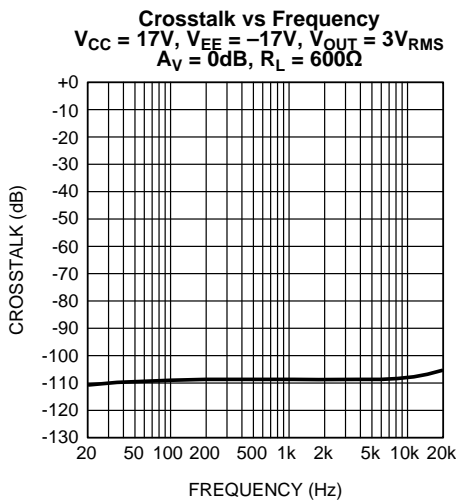

Figure 49.

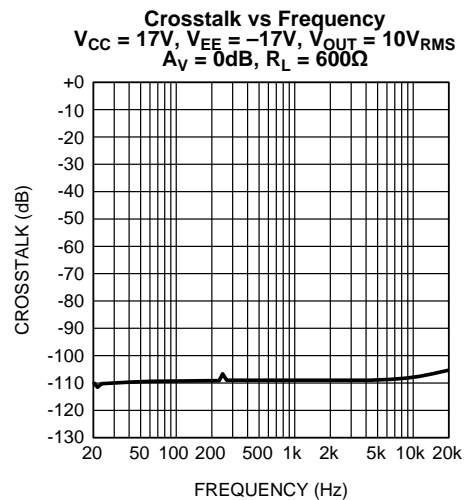

Figure 50.

TYPICAL PERFORMANCE CHARACTERISTICS (continued)

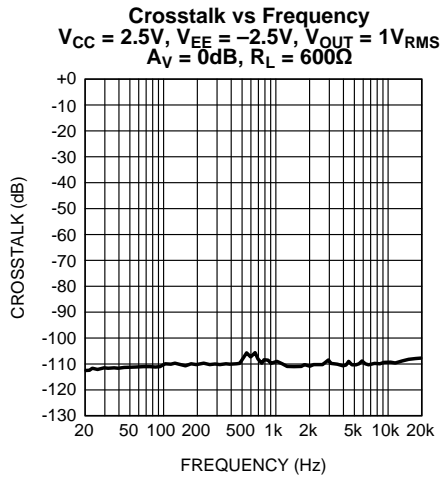

Figure 51.

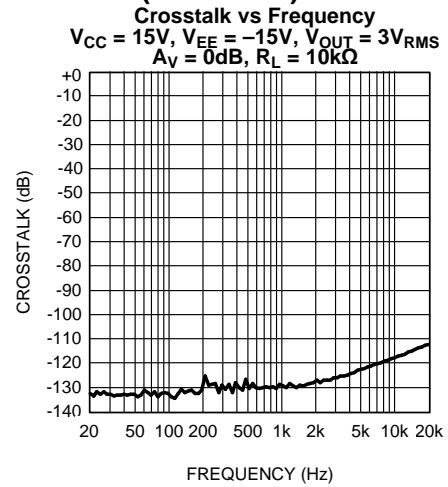

Figure 52.

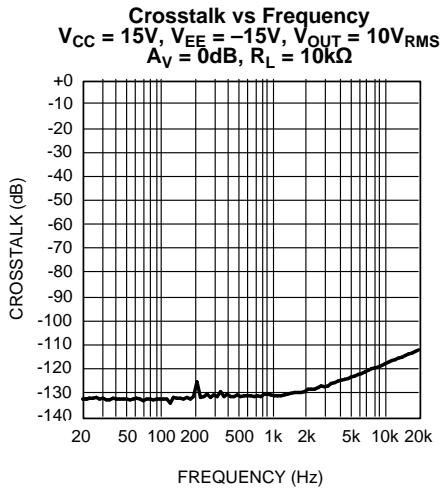

Figure 53.

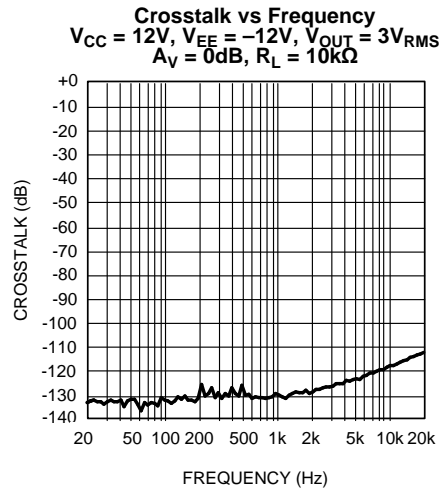

Figure 54.

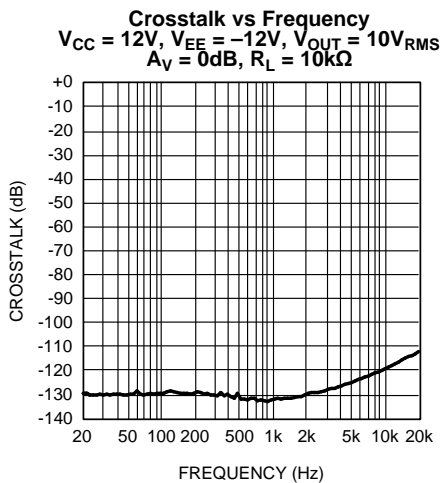

Figure 55.

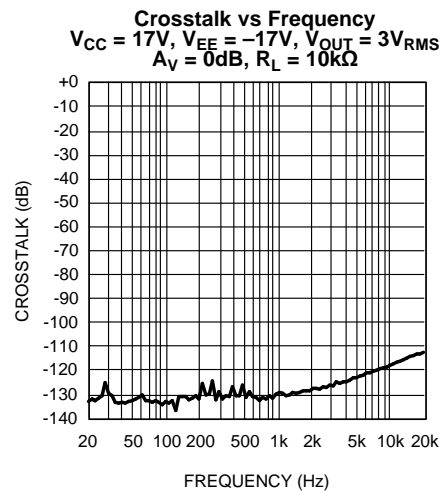

Figure 56.

TYPICAL PERFORMANCE CHARACTERISTICS (continued)

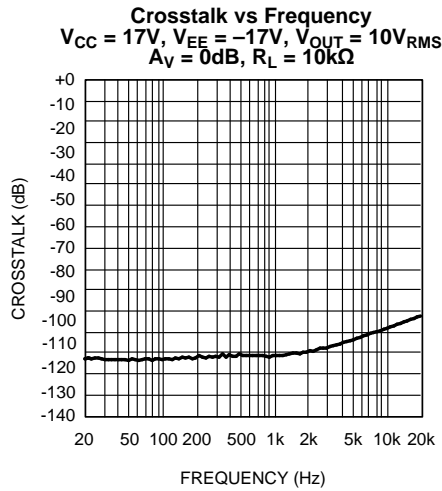

Figure 57.

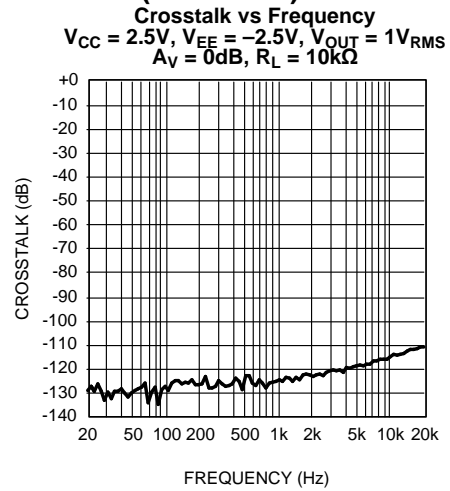

Figure 58.

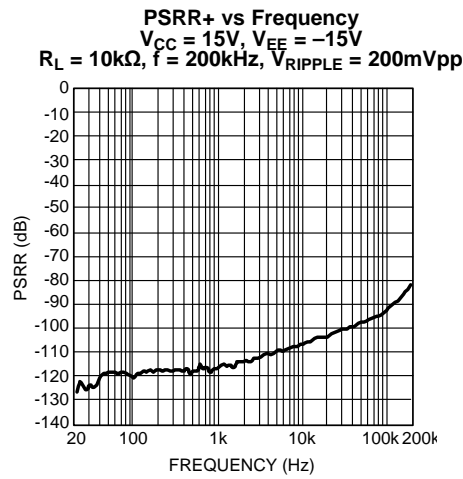

Figure 59.

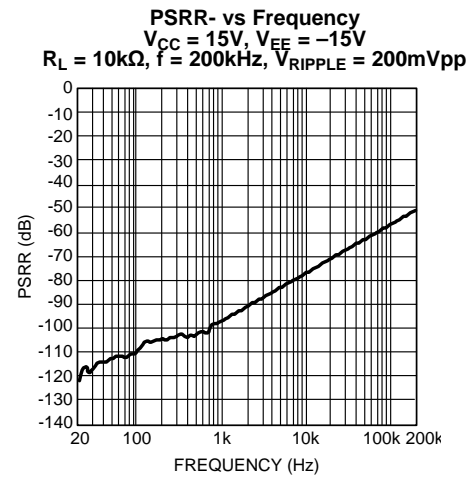

Figure 60.

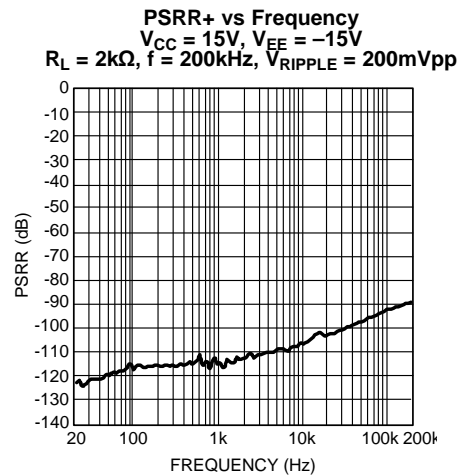

Figure 61.

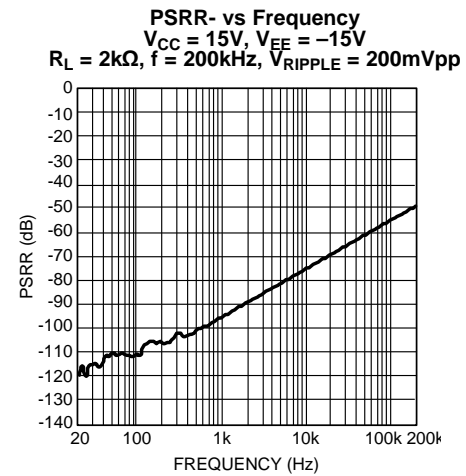

Figure 62.

TYPICAL PERFORMANCE CHARACTERISTICS (continued)

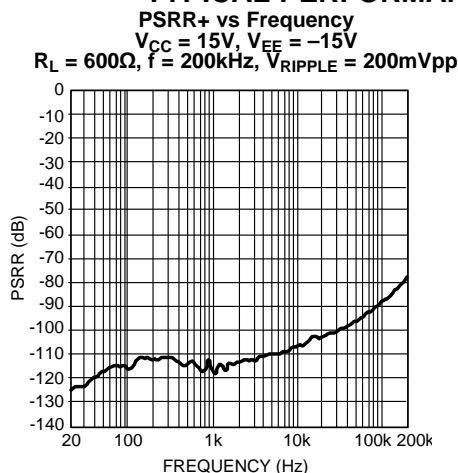

Figure 63.

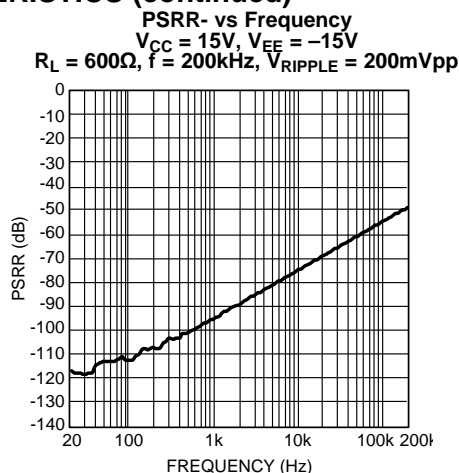

Figure 64.

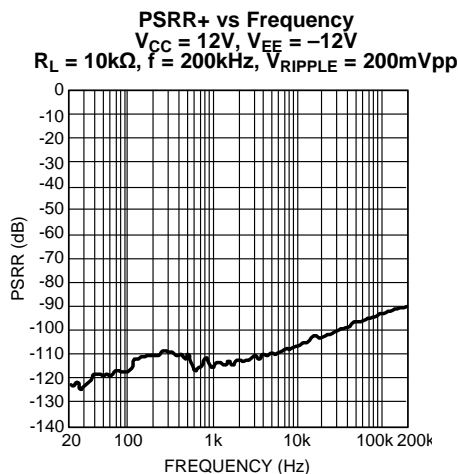

Figure 65.

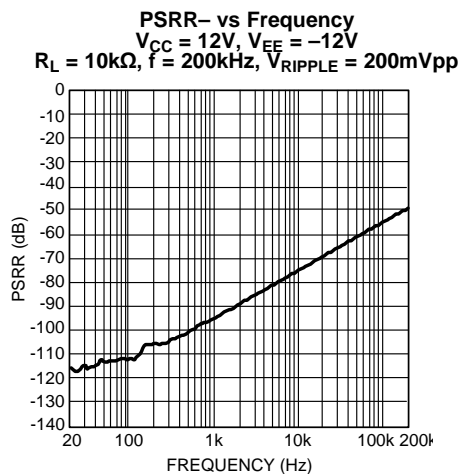

Figure 66.

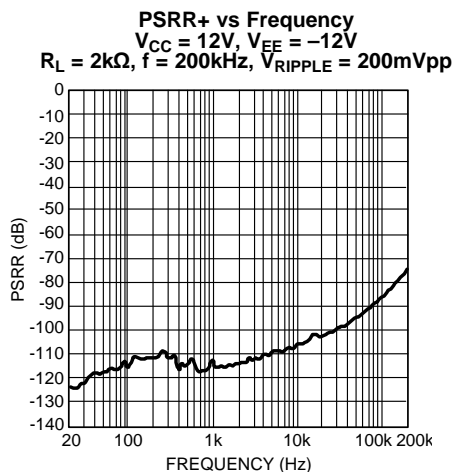

Figure 67.

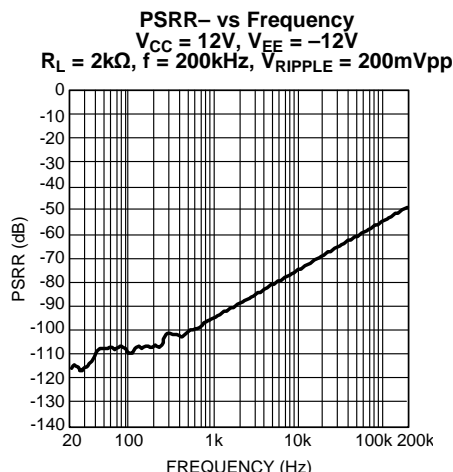

Figure 68.

TYPICAL PERFORMANCE CHARACTERISTICS (continued)

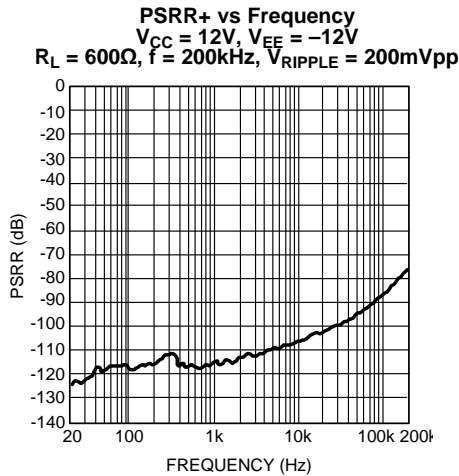

Figure 69.

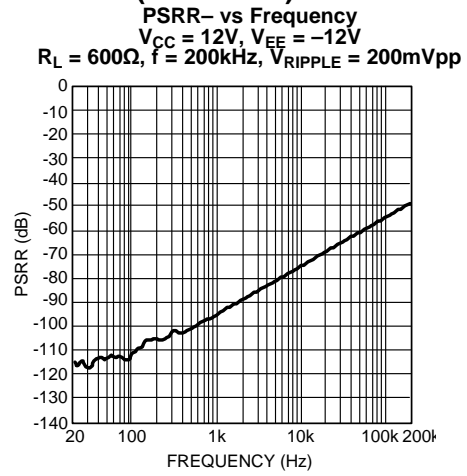

Figure 70.

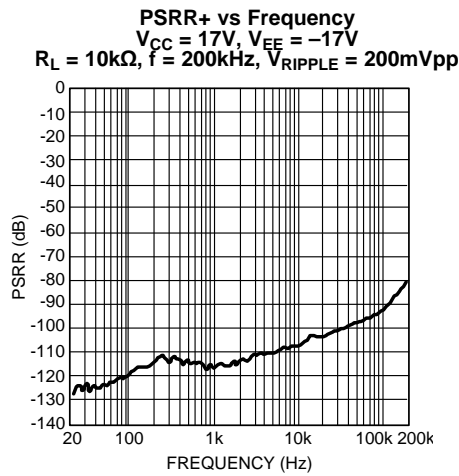

Figure 71.

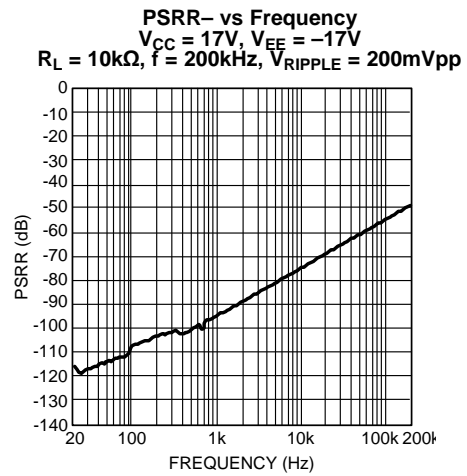

Figure 72.

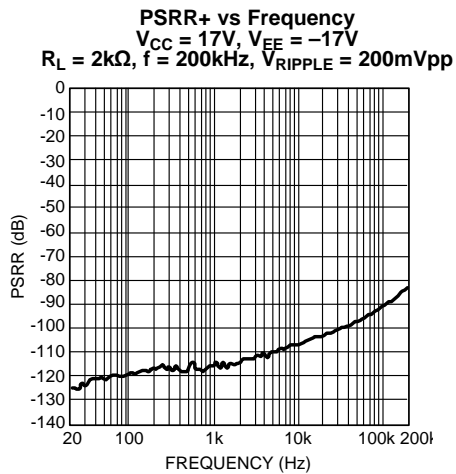

Figure 73.

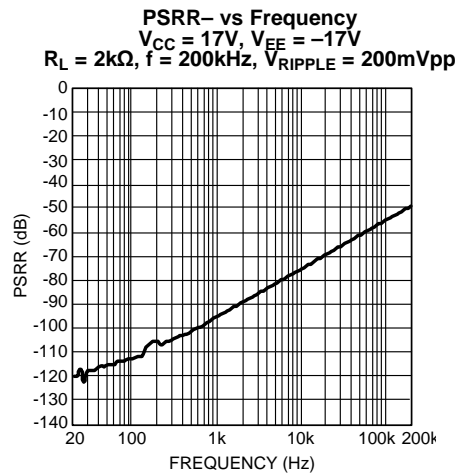

Figure 74.

TYPICAL PERFORMANCE CHARACTERISTICS (continued)

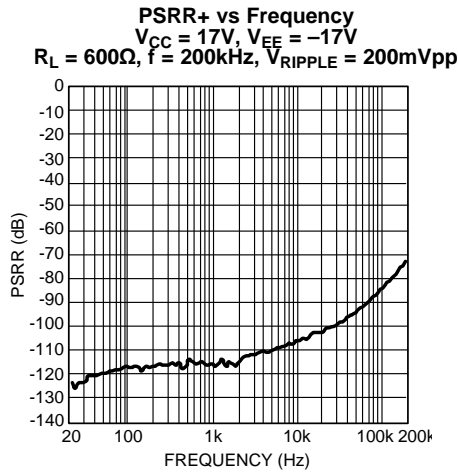

Figure 75.

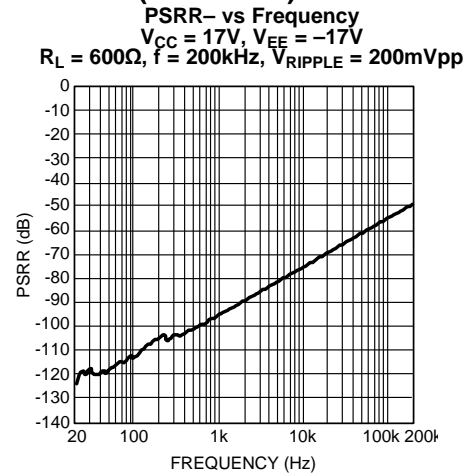

Figure 76.

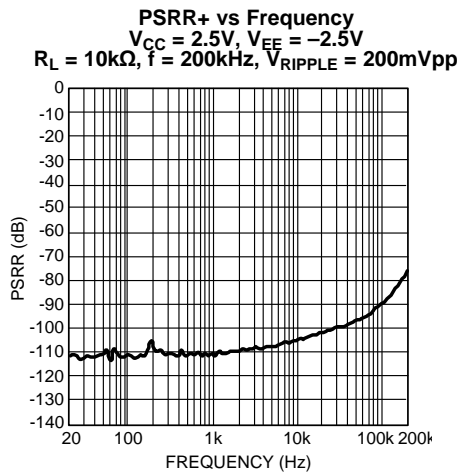

Figure 77.

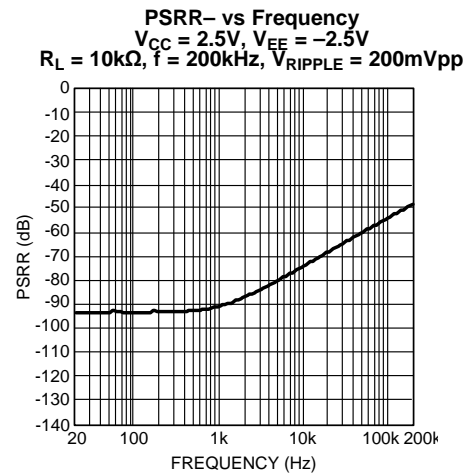

Figure 78.

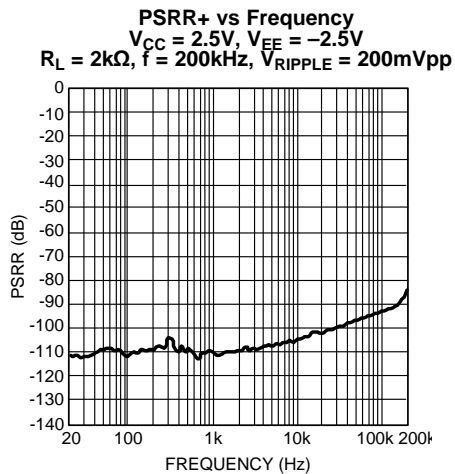

Figure 79.

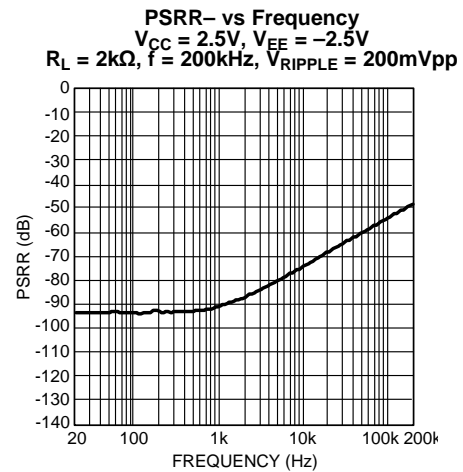

Figure 80.

TYPICAL PERFORMANCE CHARACTERISTICS (continued)

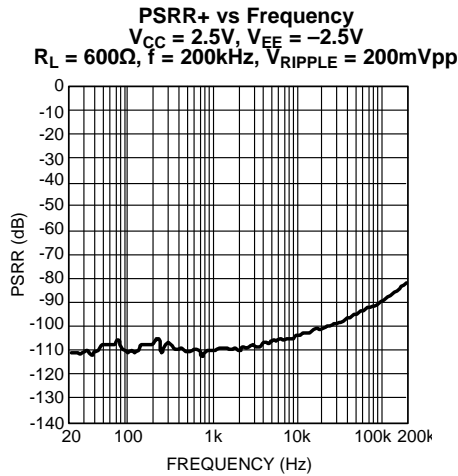

Figure 81.

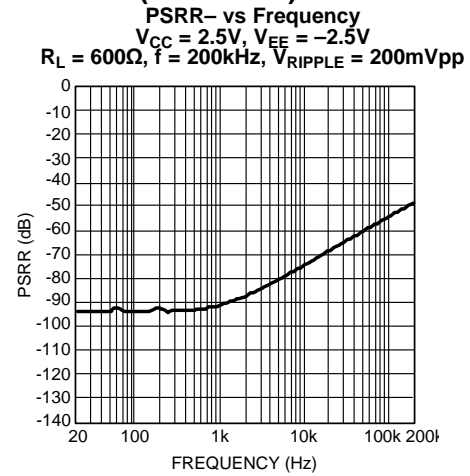

Figure 82.

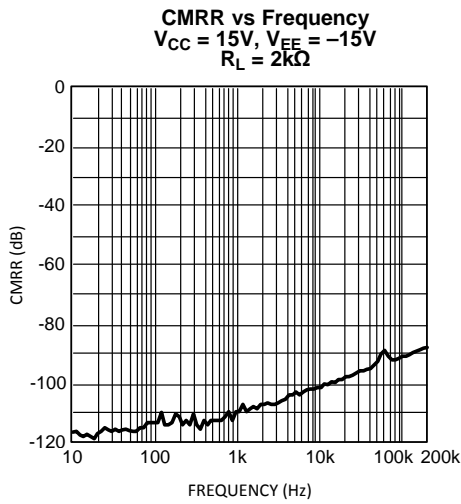

Figure 83.

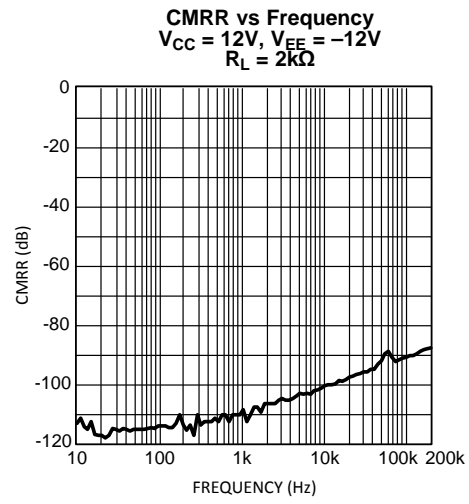

Figure 84.

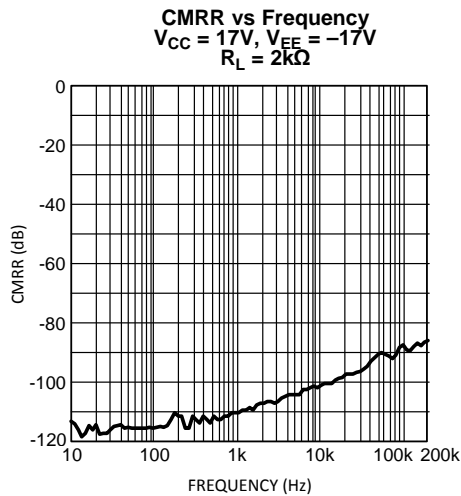

Figure 85.

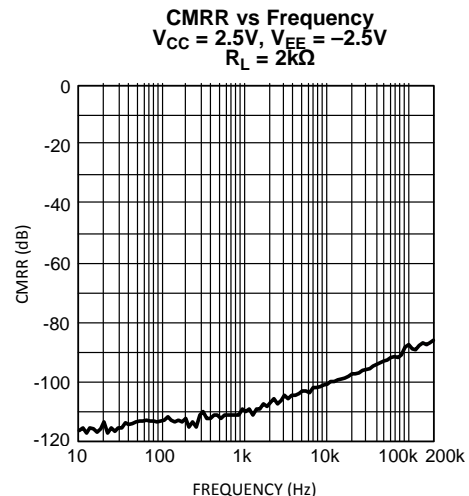

Figure 86.

TYPICAL PERFORMANCE CHARACTERISTICS (continued)

CMRR vs Frequency
 $V_{CC} = 15V, V_{EE} = -15V$
 $R_L = 600\Omega$

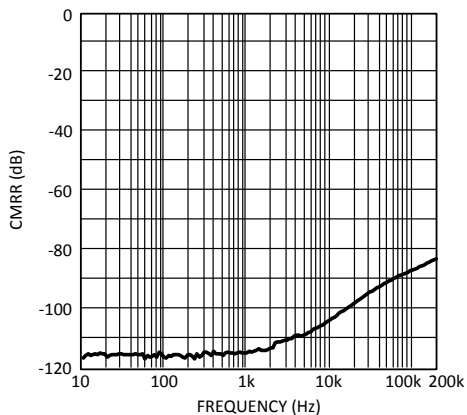

Figure 87.

CMRR vs Frequency
 $V_{CC} = 12V, V_{EE} = -12V$
 $R_L = 600\Omega$

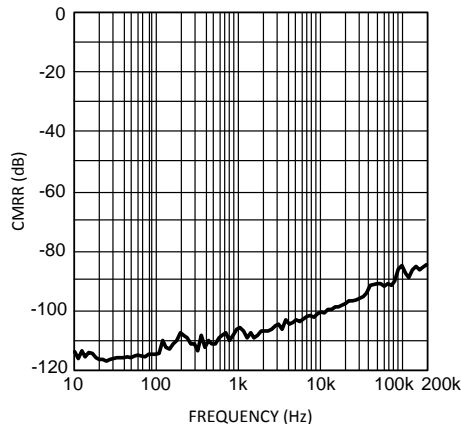

Figure 88.

CMRR vs Frequency
 $V_{CC} = 17V, V_{EE} = -17V$
 $R_L = 600\Omega$

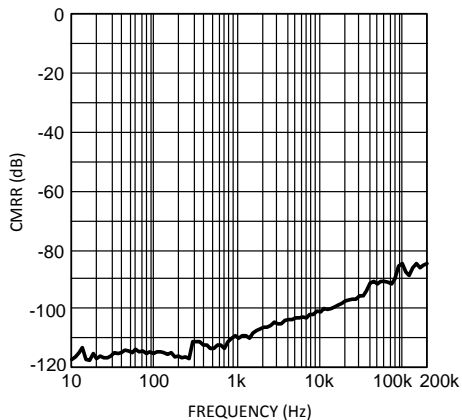

Figure 89.

CMRR vs Frequency
 $V_{CC} = 2.5V, V_{EE} = -2.5V$
 $R_L = 600\Omega$

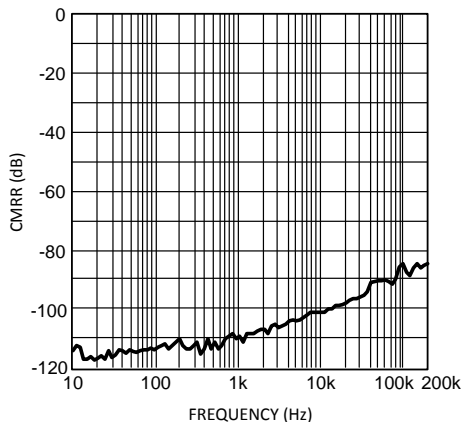

Figure 90.

CMRR vs Frequency
 $V_{CC} = 15V, V_{EE} = -15V$
 $R_L = 10k\Omega$

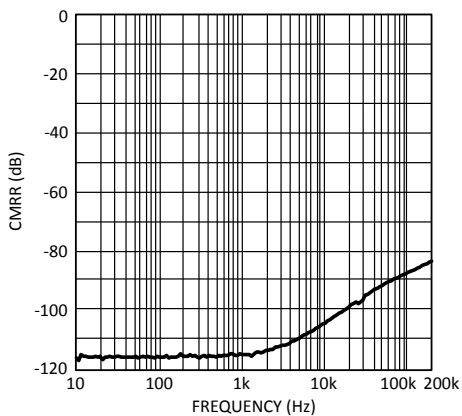

Figure 91.

CMRR vs Frequency
 $V_{CC} = 12V, V_{EE} = -12V$
 $R_L = 10k\Omega$

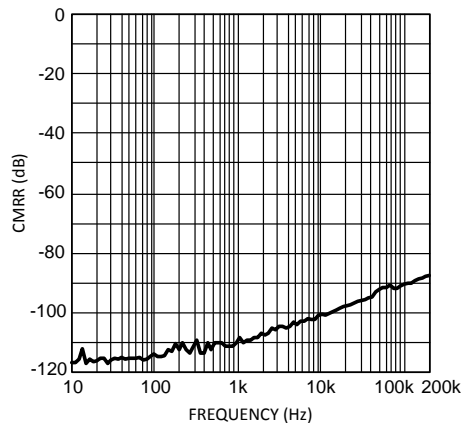

Figure 92.

TYPICAL PERFORMANCE CHARACTERISTICS (continued)

CMRR vs Frequency
 $V_{CC} = 17V, V_{EE} = -17V$
 $R_L = 10k\Omega$

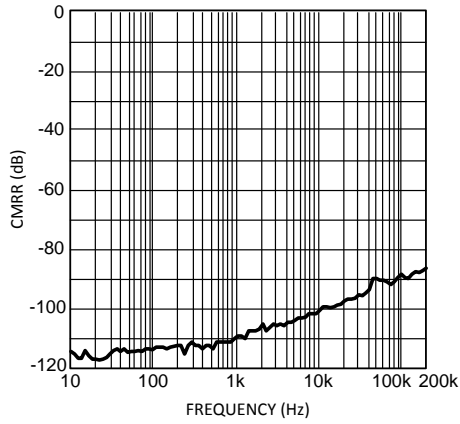

Figure 93.

CMRR vs Frequency
 $V_{CC} = 2.5V, V_{EE} = -2.5V$
 $R_L = 10k\Omega$

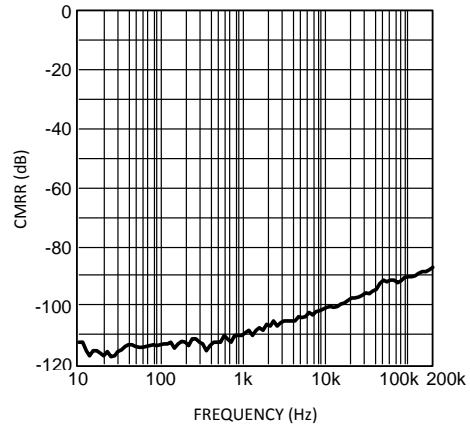

Figure 94.

Output Voltage vs Load Resistance
 $V_{DD} = 15V, V_{EE} = -15V$
 $THD+N = 1\%$

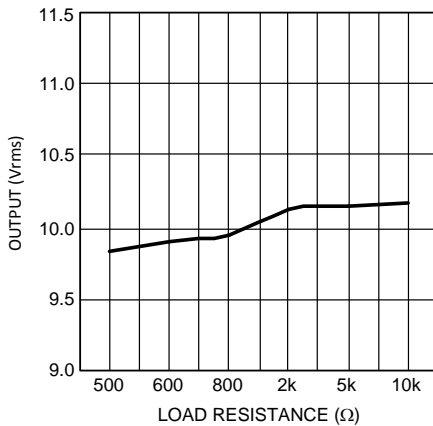

Figure 95.

Output Voltage vs Load Resistance
 $V_{DD} = 12V, V_{EE} = -12V$
 $THD+N = 1\%$

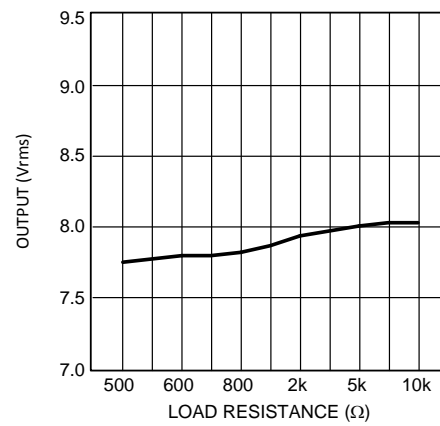

Figure 96.

Output Voltage vs Load Resistance
 $V_{DD} = 17V, V_{EE} = -17V$
 $THD+N = 1\%$

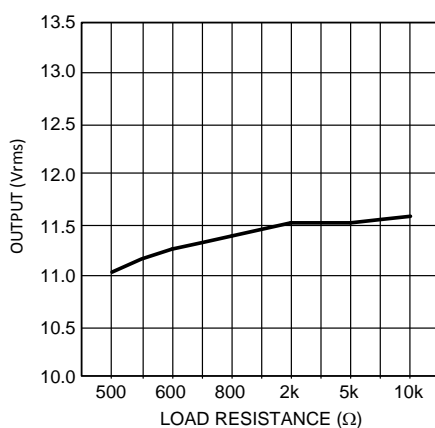

Figure 97.

Output Voltage vs Load Resistance
 $V_{DD} = 2.5V, V_{EE} = -2.5V$
 $THD+N = 1\%$

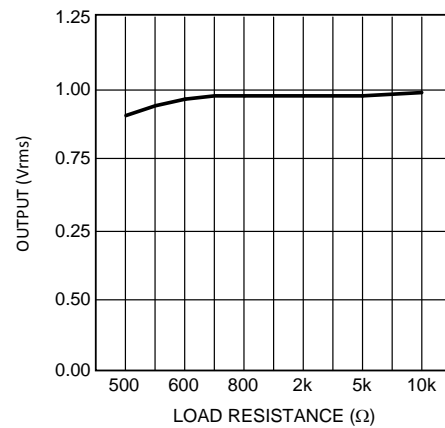

Figure 98.

TYPICAL PERFORMANCE CHARACTERISTICS (continued)

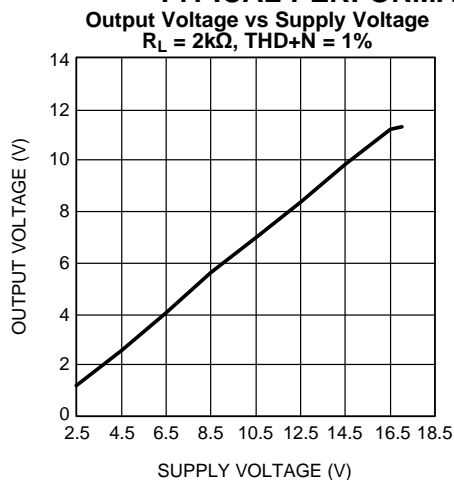

Figure 99.

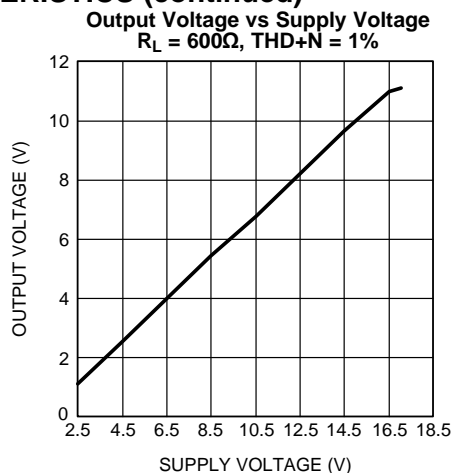

Figure 100.

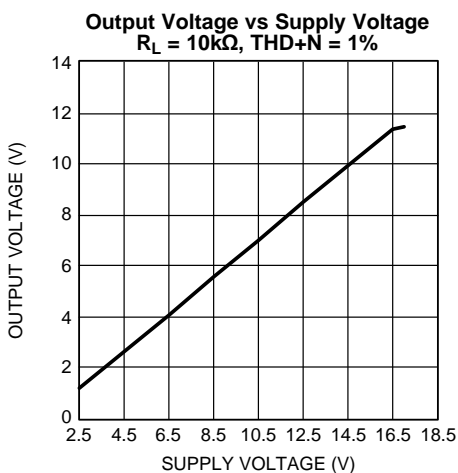

Figure 101.

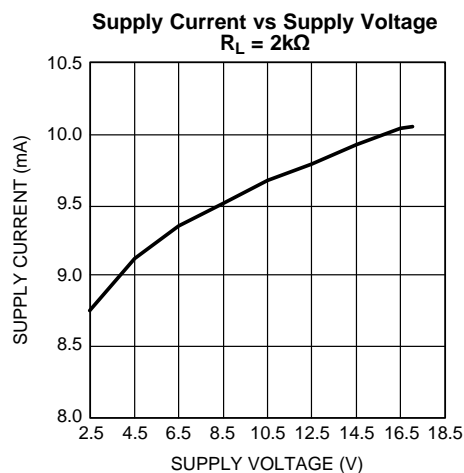

Figure 102.

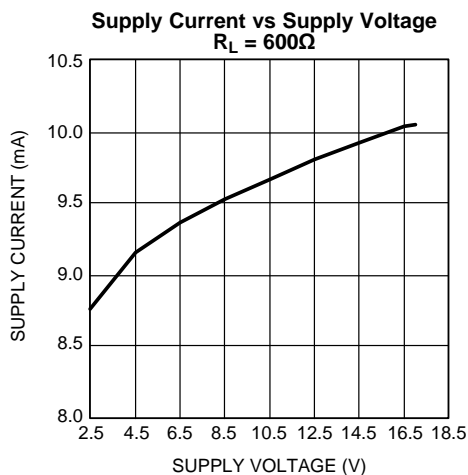

Figure 103.

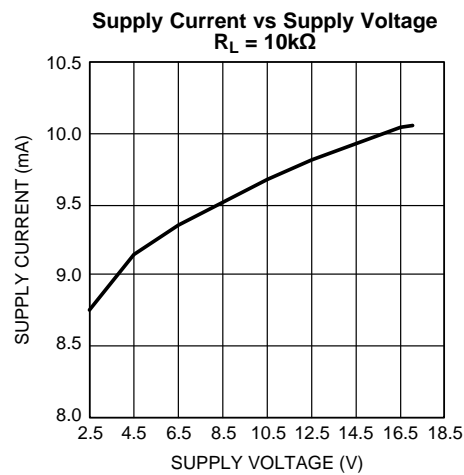

Figure 104.

TYPICAL PERFORMANCE CHARACTERISTICS (continued)

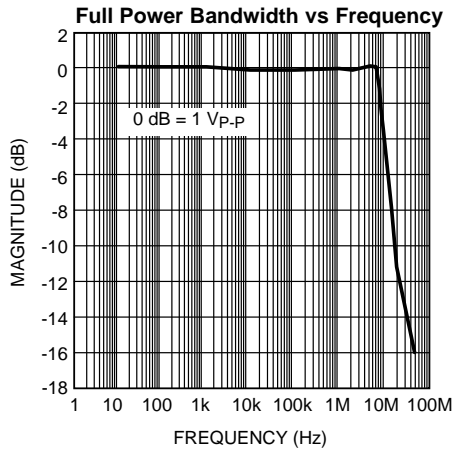

Figure 105.

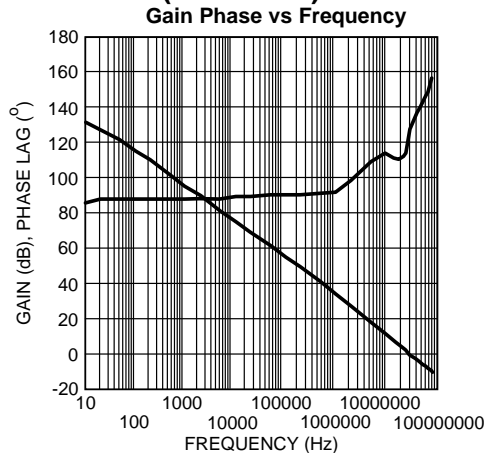

Figure 106.

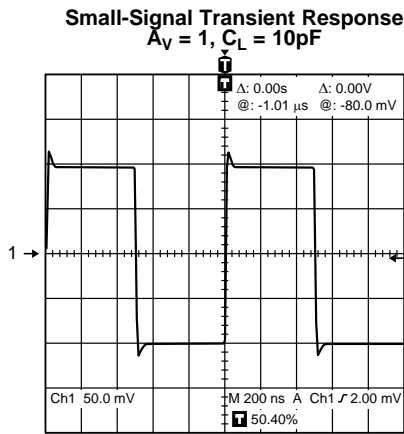

Figure 107.

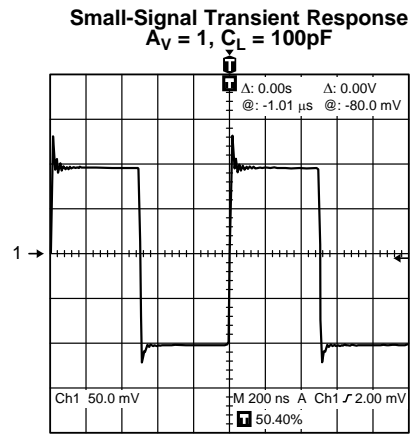

Figure 108.

APPLICATION INFORMATION

DISTORTION MEASUREMENTS

The vanishingly low residual distortion produced by LM4562 is below the capabilities of all commercially available equipment. This makes distortion measurements just slightly more difficult than simply connecting a distortion meter to the amplifier's inputs and outputs. The solution, however, is quite simple: an additional resistor. Adding this resistor extends the resolution of the distortion measurement equipment.

The LM4562's low residual distortion is an input referred internal error. As shown in Figure 109, adding the 10Ω resistor connected between the amplifier's inverting and non-inverting inputs changes the amplifier's noise gain. The result is that the error signal (distortion) is amplified by a factor of 101. Although the amplifier's closed-loop gain is unaltered, the feedback available to correct distortion errors is reduced by 101, which means that measurement resolution increases by 101. To ensure minimum effects on distortion measurements, keep the value of R1 low as shown in Figure 109.

This technique is verified by duplicating the measurements with high closed loop gain and/or making the measurements at high frequencies. Doing so produces distortion components that are within the measurement equipment's capabilities. This datasheet's THD+N and IMD values were generated using the above described circuit connected to an Audio Precision System Two Cascade.

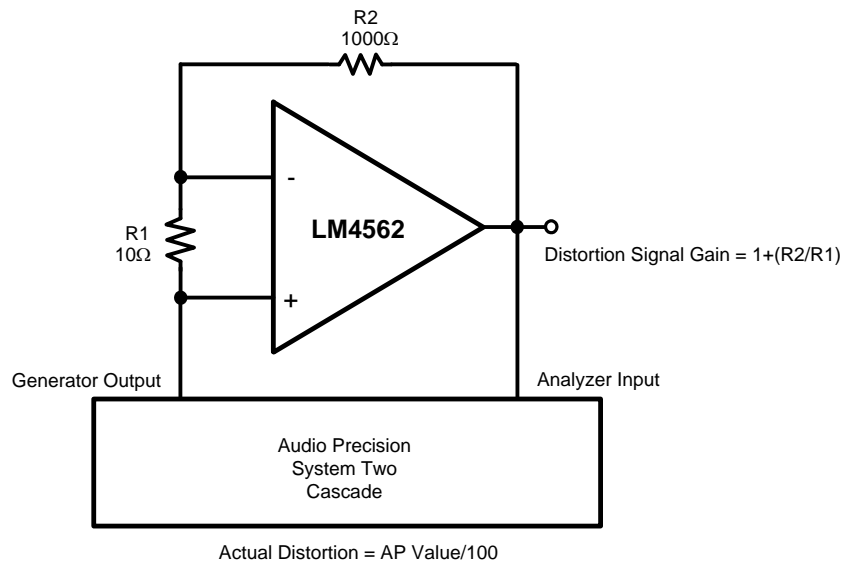
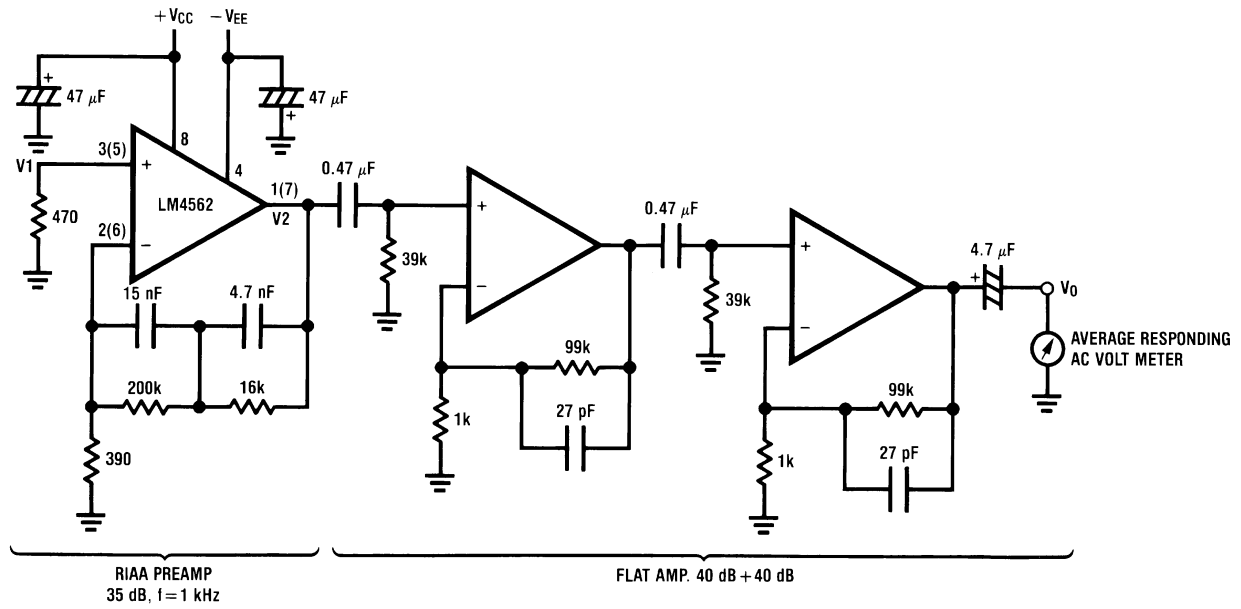

Figure 109. THD+N and IMD Distortion Test Circuit

The LM4562 is a high-speed op amp with excellent phase margin and stability. Capacitive loads up to 100pF will cause little change in the phase characteristics of the amplifiers and are therefore allowable.

Capacitive loads greater than 100pF must be isolated from the output. The most straightforward way to do this is to put a resistor in series with the output. This resistor will also prevent excess power dissipation if the output is accidentally shorted.



- A. Complete shielding is required to prevent induced pick up from external sources. Always check with oscilloscope for power line noise.

Figure 110. Noise Measurement Circuit
Total Gain: 115 dB @ f = 1 kHz
Input Referred Noise Voltage: $e_n = V_0/560,000$ (V)

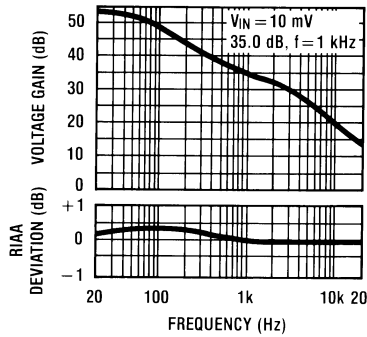

Figure 111. RIAA Preamp Voltage Gain, RIAA Deviation vs Frequency

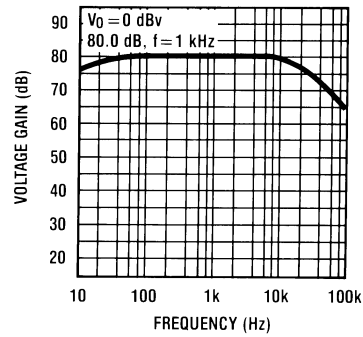

Figure 112. Flat Amp Voltage Gain vs Frequency

Evaluation Module Schematic

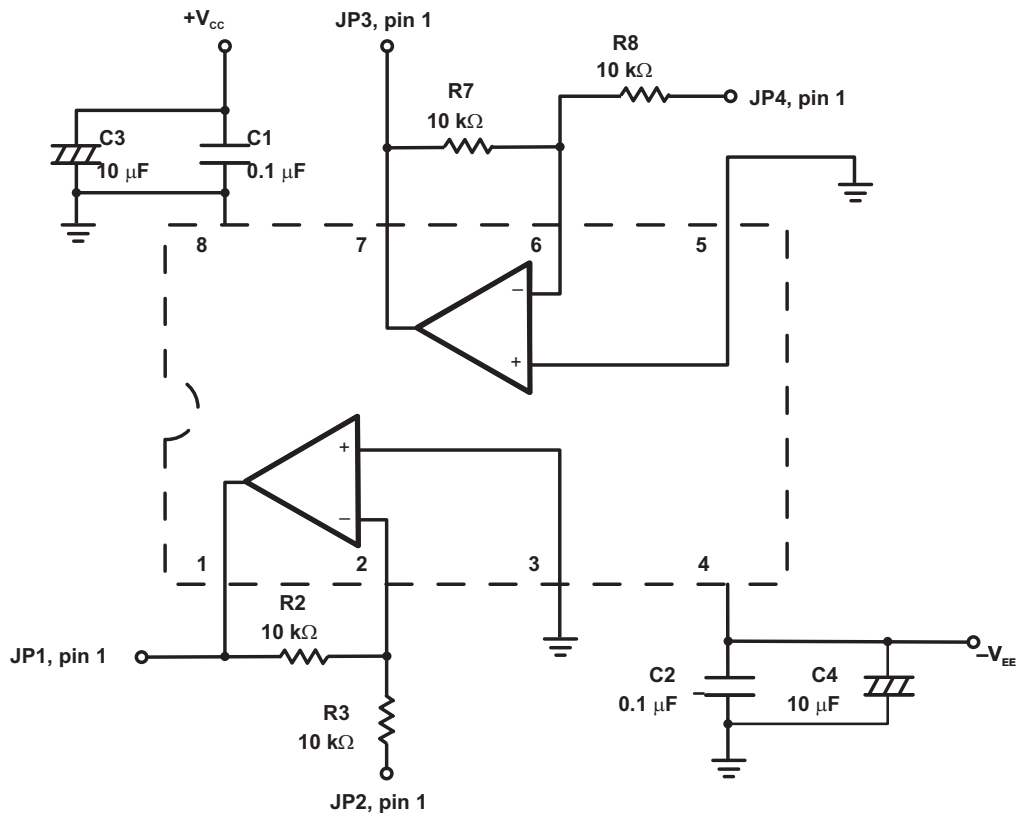
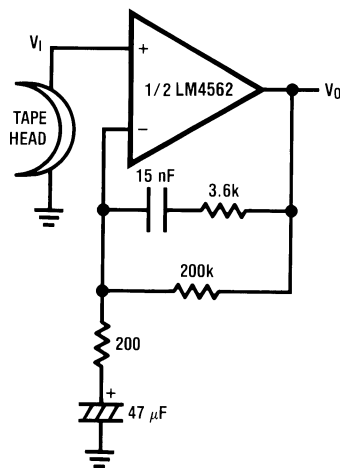

Figure 113. Inverting Amplifiers

Typical Applications



$A_V = 34.5$
 $F = 1 \text{ kHz}$
 $E_n = 0.38 \mu\text{V}$
 A Weighted

Figure 114. NAB Preamp

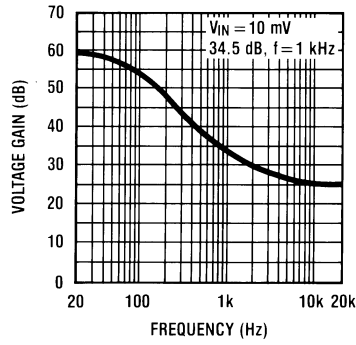
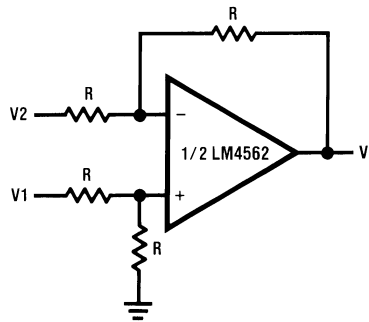
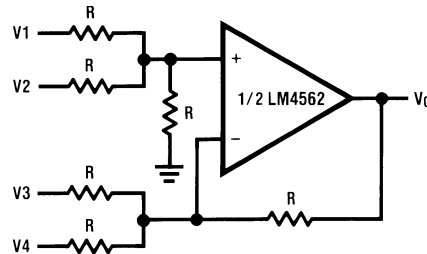

Figure 115. NAB Preamp Voltage Gain vs Frequency



$$V_O = V_1 - V_2$$

Figure 116. Balanced to Single-Ended Converter



$$V_O = V_1 + V_2 - V_3 - V_4$$

Figure 117. Adder/Subtractor

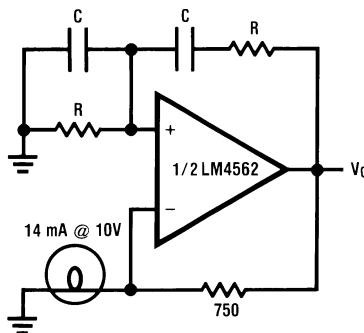

$$f_o = \frac{1}{2\pi RC}$$

Figure 118. Sine Wave Oscillator

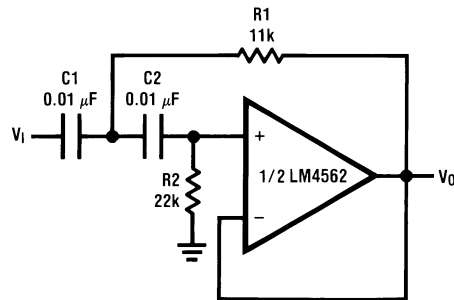

if $C1 = C2 = C$

$$R1 = \frac{\sqrt{2}}{2\omega_0 C}$$

$$R2 = 2 \cdot R1$$

Illustration is $f_0 = 1 \text{ kHz}$

Figure 119. Second-Order High-Pass Filter (Butterworth)

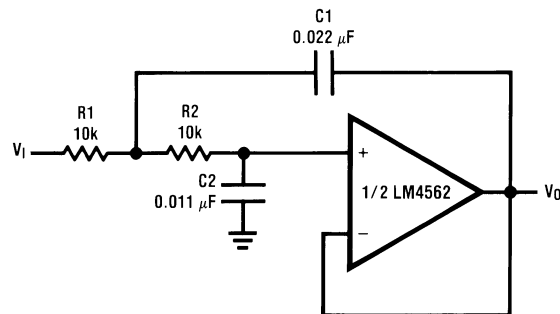

if $R1 = R2 = R$

$$C1 = \frac{\sqrt{2}}{\omega_0 R}$$

$$C2 = \frac{C1}{2}$$

Illustration is $f_0 = 1 \text{ kHz}$

Figure 120. Second-Order Low-Pass Filter (Butterworth)

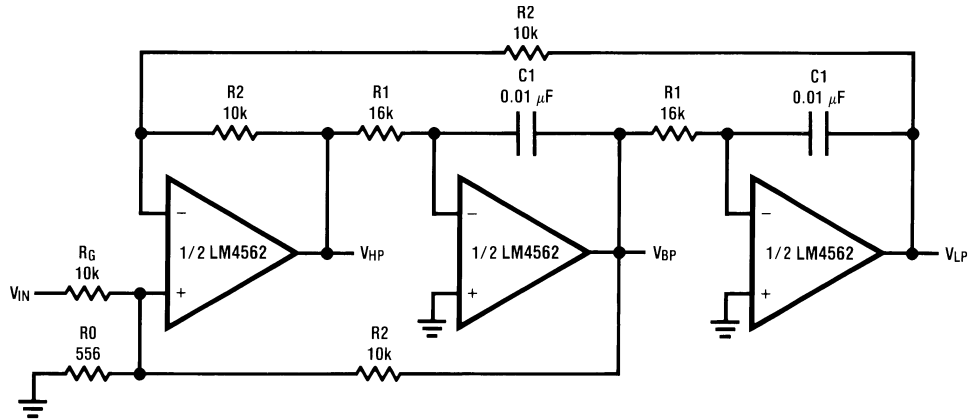

$$f_0 = \frac{1}{2\pi C1 R1}, Q = \frac{1}{2} \left(1 + \frac{R2}{R0} + \frac{R2}{RG} \right), A_{BP} = Q A_{LP} = Q A_{LH} = \frac{R2}{RG}$$

Illustration is $f_0 = 1 \text{ kHz}$, $Q = 10$, $A_{BP} = 1$

Figure 121. State Variable Filter

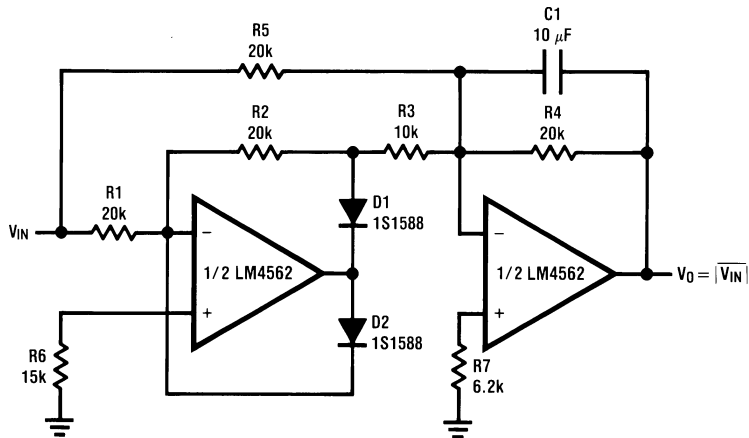

Figure 122. AC/DC Converter

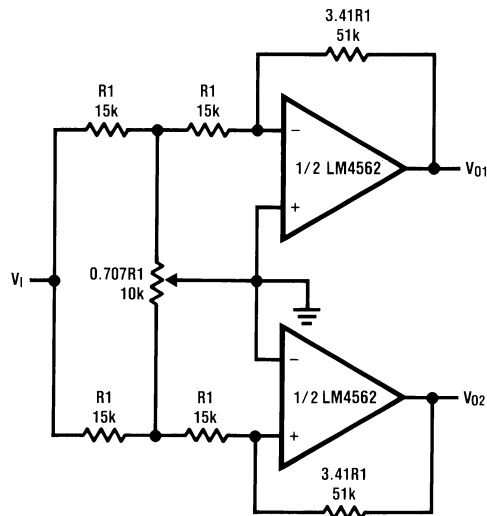

Figure 123. 2-Channel Panning Circuit (Pan Pot)

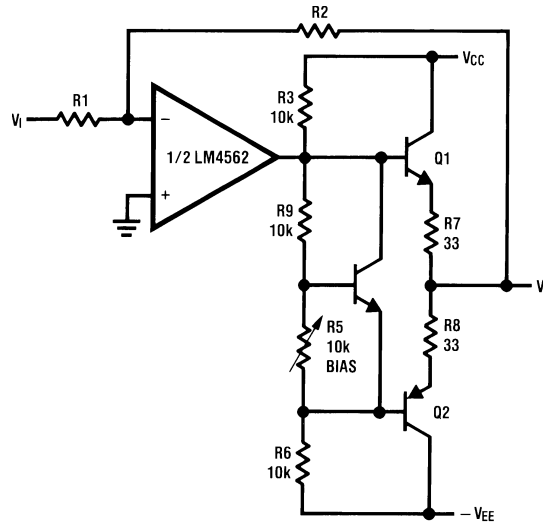
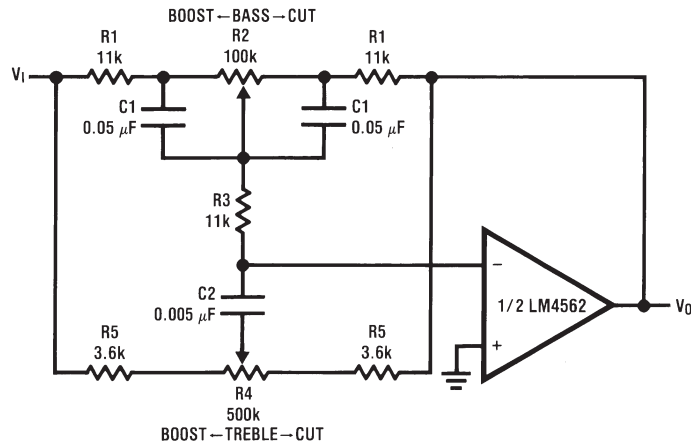

Figure 124. Line Driver



$$f_L \approx \frac{1}{2\pi R_2 C_1}, f_{LB} \approx \frac{1}{2\pi R_1 C_1}$$

$$f_H \approx \frac{1}{2\pi R_5 C_2}, f_{HB} \approx \frac{1}{2\pi (R_1 + R_5 + 2R_3) C_2}$$

The equations started above are simplifications, providing guidance of general -3dB point values, when the potentiometers are at their null position.

Illustration is:

$$f_L \approx 32 \text{ Hz}, f_{LB} \approx 320 \text{ Hz}$$

$$f_H \approx 11 \text{ kHz}, f_{HB} \approx 1.1 \text{ kHz}$$

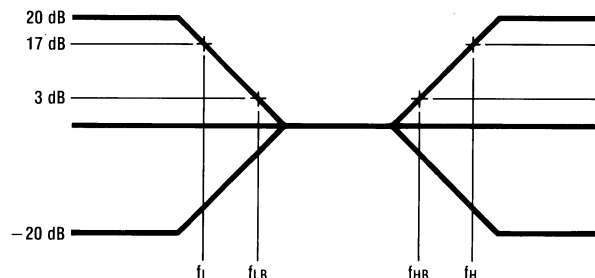
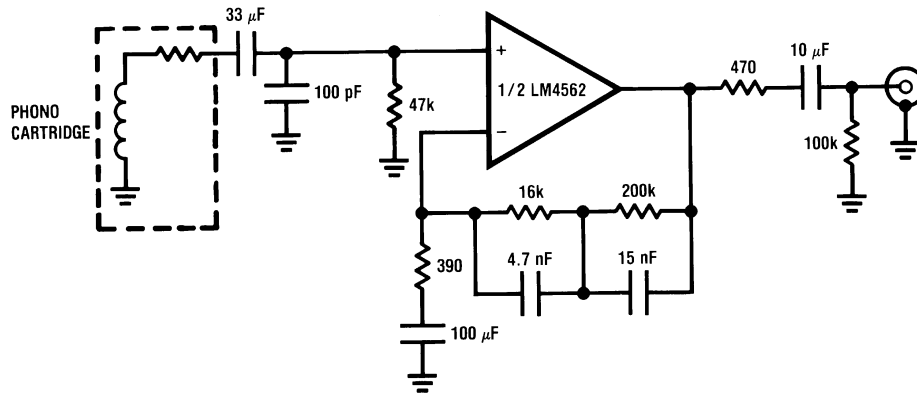
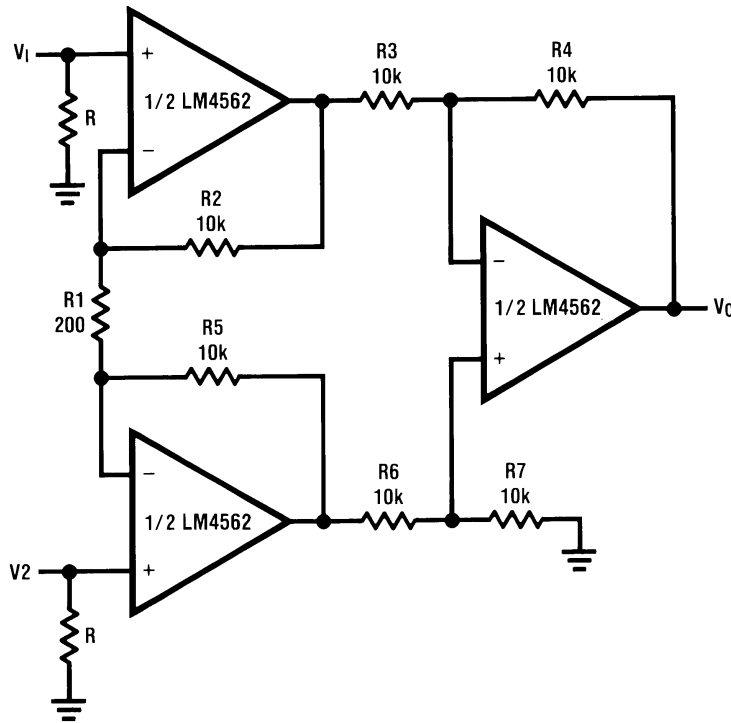

Figure 125. Tone Control



$A_v = 35 \text{ dB}$
 $E_n = 0.33 \mu\text{V S/N} = 90 \text{ dB}$
 $f = 1 \text{ kHz}$
 A Weighted
 A Weighted, $V_{IN} = 10 \text{ mV}$
 @ $f = 1 \text{ kHz}$

Figure 126. RIAA Preamp



If $R_2 = R_5$, $R_3 = R_6$, $R_4 = R_7$

$$V_0 = \left(1 + \frac{2R_2}{R_1}\right) \frac{R_4}{R_3} (V_2 - V_1)$$

Illustration is:

$$V_0 = 101(V_2 - V_1)$$

Figure 127. Balanced Input Mic Amp

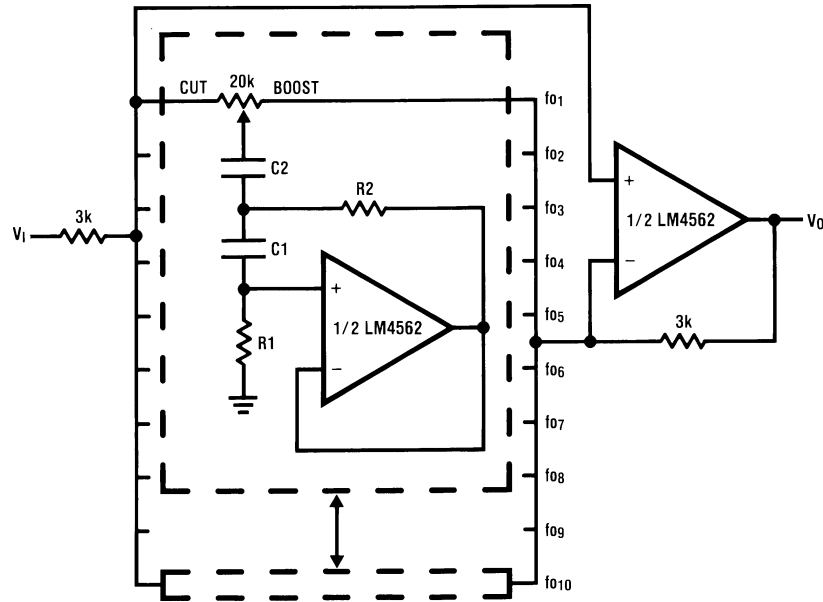

A. See [Table 1](#).

Figure 128. 10-Band Graphic Equalizer

Table 1. C_1 , C_2 , R_1 , and R_2 Values for [Figure 128](#)⁽¹⁾

f_o (Hz)	C_1	C_2	R_1	R_2
32	0.12 μ F	4.7 μ F	75k Ω	500 Ω
64	0.056 μ F	3.3 μ F	68k Ω	510 Ω
125	0.033 μ F	1.5 μ F	62k Ω	510 Ω
250	0.015 μ F	0.82 μ F	68k Ω	470 Ω
500	8200pF	0.39 μ F	62k Ω	470 Ω
1k	3900pF	0.22 μ F	68k Ω	470 Ω
2k	2000pF	0.1 μ F	68k Ω	470 Ω
4k	1100pF	0.056 μ F	62k Ω	470 Ω
8k	510pF	0.022 μ F	68k Ω	510 Ω
16k	330pF	0.012 μ F	51k Ω	510 Ω

(1) At volume of change = ± 12 dB $Q = 1.7$

REVISION HISTORY

Changes from Revision J (April 2013) to Revision K	Page
• Added EVM schematic	25

REVISION HISTORY

Rev	Date	Description
1.0	08/16/06	Initial release.
1.1	08/22/06	Updated the Instantaneous Short Circuit Current specification.
1.2	09/12/06	Updated the three $\pm 15\text{V}$ CMRR Typical Performance Curves.
1.3	09/26/06	Updated interstage filter capacitor values on page 1 Typical Application schematic.
1.4	05/03/07	Added the “general note” under the EC table.
1.5	10/17/07	Replaced all the PSRR curves.
1.6	01/26/10	Edited the equations on page 28 (under Tone Control).
J	04/04/13	Changed layout of National Data Sheet to TI format

PACKAGING INFORMATION

Orderable Device	Status (1)	Package Type	Package Drawing	Pins	Package Qty	Eco Plan (2)	Lead/Ball Finish (6)	MSL Peak Temp (3)	Op Temp (°C)	Device Marking (4/5)	Samples
LM4562MA/NOPB	ACTIVE	SOIC	D	8	95	Green (RoHS & no Sb/Br)	SN	Level-1-260C-UNLIM	-40 to 85	L4562 MA	Samples
LM4562MAX/NOPB	ACTIVE	SOIC	D	8	2500	Green (RoHS & no Sb/Br)	SN	Level-1-260C-UNLIM	-40 to 85	L4562 MA	Samples
LM4562NA/NOPB	ACTIVE	PDIP	P	8	40	Green (RoHS & no Sb/Br)	SN	Level-1-NA-UNLIM	-40 to 85	LM 4562NA	Samples

(1) The marketing status values are defined as follows:

ACTIVE: Product device recommended for new designs.

LIFEBUY: TI has announced that the device will be discontinued, and a lifetime-buy period is in effect.

NRND: Not recommended for new designs. Device is in production to support existing customers, but TI does not recommend using this part in a new design.

PREVIEW: Device has been announced but is not in production. Samples may or may not be available.

OBSELETE: TI has discontinued the production of the device.

(2) **RoHS:** TI defines "RoHS" to mean semiconductor products that are compliant with the current EU RoHS requirements for all 10 RoHS substances, including the requirement that RoHS substance do not exceed 0.1% by weight in homogeneous materials. Where designed to be soldered at high temperatures, "RoHS" products are suitable for use in specified lead-free processes. TI may reference these types of products as "Pb-Free".

RoHS Exempt: TI defines "RoHS Exempt" to mean products that contain lead but are compliant with EU RoHS pursuant to a specific EU RoHS exemption.

Green: TI defines "Green" to mean the content of Chlorine (Cl) and Bromine (Br) based flame retardants meet JS709B low halogen requirements of <=1000ppm threshold. Antimony trioxide based flame retardants must also meet the <=1000ppm threshold requirement.

(3) MSL, Peak Temp. - The Moisture Sensitivity Level rating according to the JEDEC industry standard classifications, and peak solder temperature.

(4) There may be additional marking, which relates to the logo, the lot trace code information, or the environmental category on the device.

(5) Multiple Device Markings will be inside parentheses. Only one Device Marking contained in parentheses and separated by a "-" will appear on a device. If a line is indented then it is a continuation of the previous line and the two combined represent the entire Device Marking for that device.

(6) Lead/Ball Finish - Orderable Devices may have multiple material finish options. Finish options are separated by a vertical ruled line. Lead/Ball Finish values may wrap to two lines if the finish value exceeds the maximum column width.

Important Information and Disclaimer:The information provided on this page represents TI's knowledge and belief as of the date that it is provided. TI bases its knowledge and belief on information provided by third parties, and makes no representation or warranty as to the accuracy of such information. Efforts are underway to better integrate information from third parties. TI has taken and continues to take reasonable steps to provide representative and accurate information but may not have conducted destructive testing or chemical analysis on incoming materials and chemicals. TI and TI suppliers consider certain information to be proprietary, and thus CAS numbers and other limited information may not be available for release.

In no event shall TI's liability arising out of such information exceed the total purchase price of the TI part(s) at issue in this document sold by TI to Customer on an annual basis.

TAPE AND REEL INFORMATION



QUADRANT ASSIGNMENTS FOR PIN 1 ORIENTATION IN TAPE



*All dimensions are nominal

Device	Package Type	Package Drawing	Pins	SPQ	Reel Diameter (mm)	Reel Width W1 (mm)	A0 (mm)	B0 (mm)	K0 (mm)	P1 (mm)	W (mm)	Pin1 Quadrant
LM4562MAX/NOPB	SOIC	D	8	2500	330.0	12.4	6.5	5.4	2.0	8.0	12.0	Q1

TAPE AND REEL BOX DIMENSIONS



*All dimensions are nominal

Device	Package Type	Package Drawing	Pins	SPQ	Length (mm)	Width (mm)	Height (mm)
LM4562MAX/NOPB	SOIC	D	8	2500	367.0	367.0	35.0



D0008A

PACKAGE OUTLINE

SOIC - 1.75 mm max height

SMALL OUTLINE INTEGRATED CIRCUIT



4214825/C 02/2019

NOTES:

1. Linear dimensions are in inches [millimeters]. Dimensions in parenthesis are for reference only. Controlling dimensions are in inches. Dimensioning and tolerancing per ASME Y14.5M.
2. This drawing is subject to change without notice.
3. This dimension does not include mold flash, protrusions, or gate burrs. Mold flash, protrusions, or gate burrs shall not exceed $.006$ [0.15] per side.
4. This dimension does not include interlead flash.
5. Reference JEDEC registration MS-012, variation AA.

EXAMPLE BOARD LAYOUT

D0008A

SOIC - 1.75 mm max height

SMALL OUTLINE INTEGRATED CIRCUIT



LAND PATTERN EXAMPLE
 EXPOSED METAL SHOWN
 SCALE:8X



SOLDER MASK DETAILS

4214825/C 02/2019

NOTES: (continued)

- 6. Publication IPC-7351 may have alternate designs.
- 7. Solder mask tolerances between and around signal pads can vary based on board fabrication site.

EXAMPLE STENCIL DESIGN

D0008A

SOIC - 1.75 mm max height

SMALL OUTLINE INTEGRATED CIRCUIT



SOLDER PASTE EXAMPLE
BASED ON .005 INCH [0.125 MM] THICK STENCIL
SCALE:8X

4214825/C 02/2019

NOTES: (continued)

8. Laser cutting apertures with trapezoidal walls and rounded corners may offer better paste release. IPC-7525 may have alternate design recommendations.
9. Board assembly site may have different recommendations for stencil design.

P (R-PDIP-T8)

PLASTIC DUAL-IN-LINE PACKAGE

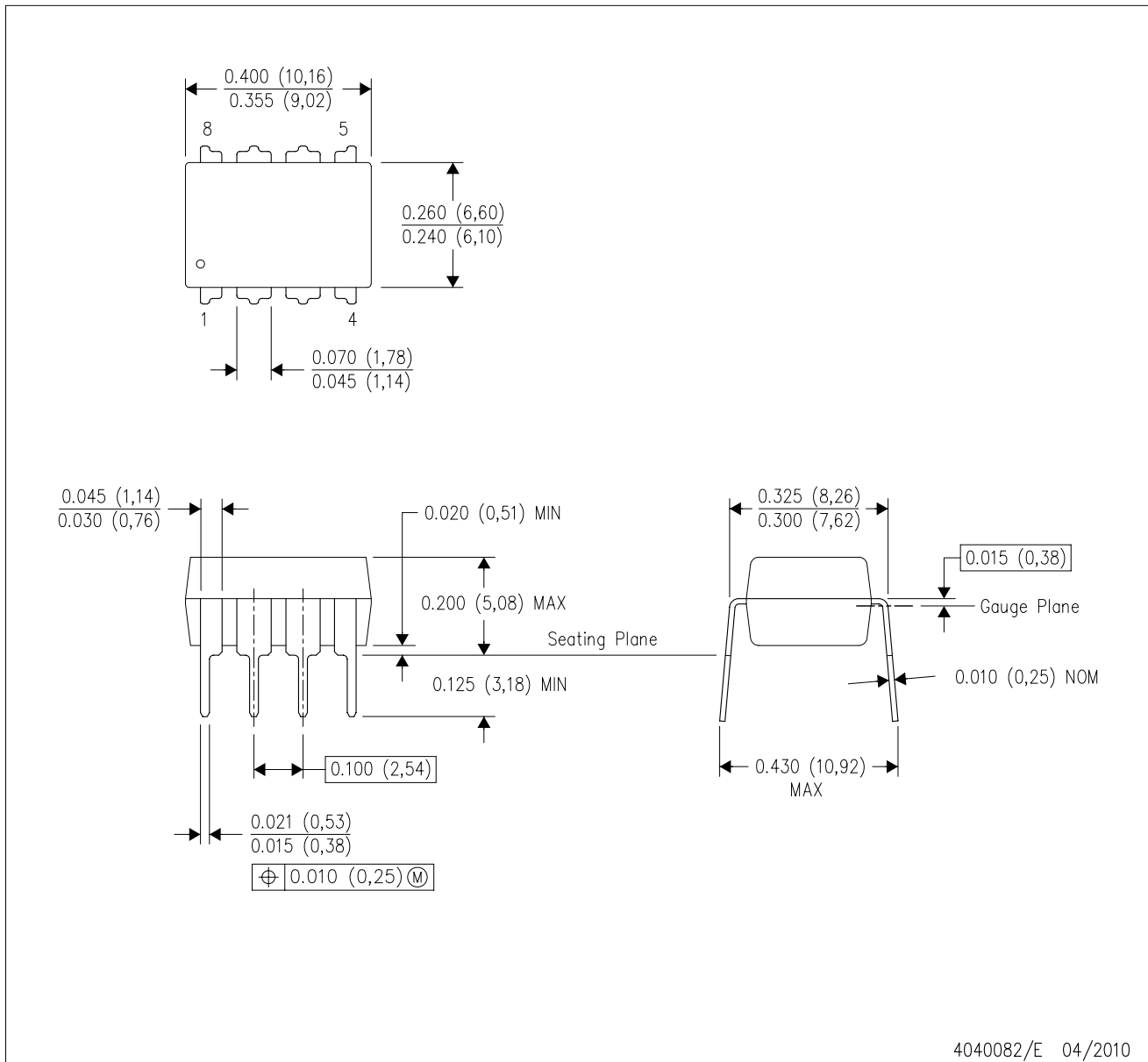

- NOTES:
- A. All linear dimensions are in inches (millimeters).
 - B. This drawing is subject to change without notice.
 - C. Falls within JEDEC MS-001 variation BA.

IMPORTANT NOTICE AND DISCLAIMER

TI PROVIDES TECHNICAL AND RELIABILITY DATA (INCLUDING DATASHEETS), DESIGN RESOURCES (INCLUDING REFERENCE DESIGNS), APPLICATION OR OTHER DESIGN ADVICE, WEB TOOLS, SAFETY INFORMATION, AND OTHER RESOURCES "AS IS" AND WITH ALL FAULTS, AND DISCLAIMS ALL WARRANTIES, EXPRESS AND IMPLIED, INCLUDING WITHOUT LIMITATION ANY IMPLIED WARRANTIES OF MERCHANTABILITY, FITNESS FOR A PARTICULAR PURPOSE OR NON-INFRINGEMENT OF THIRD PARTY INTELLECTUAL PROPERTY RIGHTS.

These resources are intended for skilled developers designing with TI products. You are solely responsible for (1) selecting the appropriate TI products for your application, (2) designing, validating and testing your application, and (3) ensuring your application meets applicable standards, and any other safety, security, or other requirements. These resources are subject to change without notice. TI grants you permission to use these resources only for development of an application that uses the TI products described in the resource. Other reproduction and display of these resources is prohibited. No license is granted to any other TI intellectual property right or to any third party intellectual property right. TI disclaims responsibility for, and you will fully indemnify TI and its representatives against, any claims, damages, costs, losses, and liabilities arising out of your use of these resources.

TI's products are provided subject to TI's Terms of Sale (www.ti.com/legal/termsofsale.html) or other applicable terms available either on ti.com or provided in conjunction with such TI products. TI's provision of these resources does not expand or otherwise alter TI's applicable warranties or warranty disclaimers for TI products.

Mailing Address: Texas Instruments, Post Office Box 655303, Dallas, Texas 75265
Copyright © 2020, Texas Instruments Incorporated