

LM48310 Boomer® Audio Power Amplifier Series

Ultra-Low EMI, Filterless, 2.6W, Mono, Class D Audio Power Amplifier with E²S

General Description

The LM48310 is a single supply, high efficiency, mono, 2.6W, filterless switching audio amplifier. The LM48310 features National's Enhanced Emissions Suppression (E²S) system, that features a unique patent-pending ultra low EMI, spread spectrum, PWM architecture, that significantly reduces RF emissions while preserving audio quality and efficiency. The E²S system improves battery life, reduces external component count, board area consumption, system cost, and simplifying design.

The LM48310 is designed to meet the demands of portable multimedia devices. Operating from a single 5V supply, the device is capable of delivering 2.6W of continuous output power to a 4Ω load with less than 10% THD+N. Flexible power supply requirements allow operation from 2.4V to 5.5V. The LM48310 offers two logic selectable modulation schemes, fixed frequency mode, and an EMI suppressing spread spectrum mode. The E²S system includes an advanced, patent-pending edge rate control (ERC) architecture that further reduce emissions by minimizing the high frequency component of the device output, while maintaining high quality audio reproduction (THD+N = 0.03%) and high efficiency (η = 88%). The LM48310 also features a SYNC_IN input and SYNC_OUT, which allows multiple devices to operate with the same switching frequency, eliminating beat frequencies and any other interference caused by clock intermodulation.

The LM48310 features high efficiency compared to conventional Class AB amplifiers, and other low EMI Class D amplifiers. When driving an 8Ω speaker from a 5V supply, the device operates with 88% efficiency at P_O = 1W. The gain of the LM48310 is internally set to 12dB, further reducing external component count. A low power shutdown mode reduces supply current consumption to 0.01μA.

Advanced output short circuit protection with auto-recovery prevents the device from being damaged during fault conditions. Superior click and pop suppression eliminates audible transients on power-up/down and during shutdown.

Key Specifications

■ Efficiency at 3.6V, 400mW into 8Ω	85% (typ)
■ Efficiency at 5V, 1W into 8Ω	88% (typ)
■ Quiescent Power Supply Current at 5V	3.2mA
■ Power Output at V _{DD} = 5V, R _L = 4Ω, THD+N ≤ 10%	2.6W (typ)
■ Power Output at V _{DD} = 5V, R _L = 8Ω, THD+N ≤ 10%	1.6W (typ)
■ Shutdown current	0.01μA (typ)

Features

- Passes FCC Class B Radiated Emissions with 20 inches of cable
- E²S System Reduces EMI while Preserving Audio Quality and Efficiency
- Output Short Circuit Protection with Auto-Recovery
- Stereo Class D operation
- No output filter required
- Internally Configured Gain (12dB)
- Synchronizable Oscillator for Multi-Channel operation
- Low power shutdown mode
- Minimum external components
- "Click and pop" suppression
- Micro-power shutdown
- Available in space-saving LLP package

Applications

- Mobile phones
- PDAs
- Laptops

EMI Graph 20in of Speaker Cable

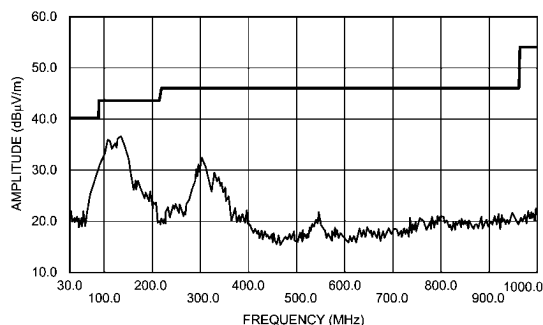

300374a0

Boomer® is a registered trademark of National Semiconductor Corporation.

Typical Application

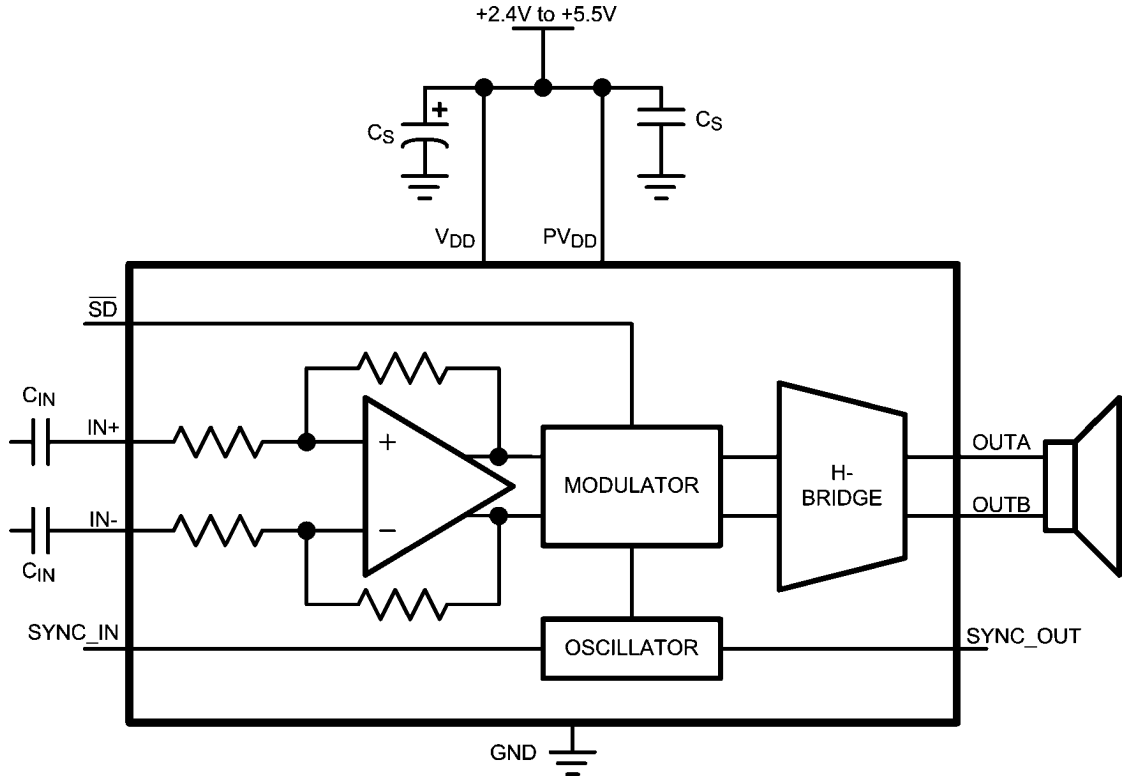

30037459

FIGURE 1. Typical Audio Amplifier Application Circuit

Connection Diagram

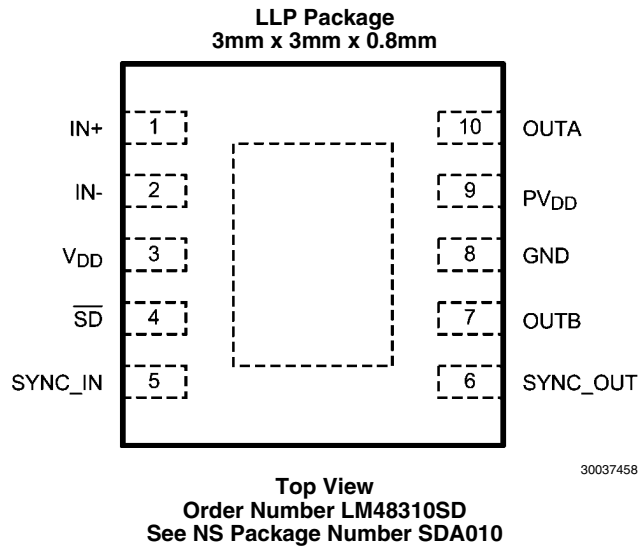

Pin Descriptions

TABLE 1.

Pin	Name	Description
1	IN+	Non-Inverting Input
2	IN-	Inverting Input
3	V _{DD}	Power Supply
4	\overline{SD}	Active Low Shutdown Input. Connect to V _{DD} for normal operation.
5	SYNC_IN	Mode Select and External Oscillator Input. SYNC_IN = V _{DD} : Spread spectrum mode with $f_S = 300\text{kHz} \pm 30\%$ SYNC_IN = GND: Fixed frequency mode with $f_S = 300\text{kHz}$ SYNC_IN = Clocked: $f_S = \text{external clock frequency}$
6	SYNC_OUT	Clock Output
7	OUTB	Inverting Output
8	GND	Ground
9	PV _{DD}	H-Bridge Power Supply
10	OUTA	Non-Inverting Output

Absolute Maximum Ratings (Notes 1, 2)

If Military/Aerospace specified devices are required, please contact the National Semiconductor Sales Office/ Distributors for availability and specifications.

Supply Voltage	6.0V
Storage Temperature	-65°C to +150°C
Input Voltage	- 0.3V to $V_{DD} + 0.3V$
Power Dissipation (Note 3)	Internally Limited
ESD Rating (Note 4)	2000V
ESD Rating (Note 5)	200V

Junction Temperature	150°C
Thermal Resistance	
θ_{JC}	49.2°C/W
θ_{JA}	8.2°C/W

Operating Ratings (Notes 1, 2)

Temperature Range	
$T_{MIN} \leq T_A \leq T_{MAX}$	-40°C \leq T_A \leq +85°C
Supply Voltage	2.4V \leq V_{DD} \leq 5.5V

Electrical Characteristics $V_{DD} = PV_{DD} = 5V$ (Notes 2, 8)

The following specifications apply for $A_V = 12dB$, ($R_L = 8\Omega$, SYNC_IN = V_{DD} (Spread Spectrum mode), $f = 1kHz$, unless otherwise specified. Limits apply for $T_A = 25^\circ C$.

Symbol	Parameter	Conditions	LM48310		Units (Limits)
			Typical	Limit	
			(Note 6)	(Notes 7, 8)	
V_{OS}	Differential Output Offset Voltage	$V_{IN} = 0$	1	3	mV (max)
I_{DD}	Quiescent Power Supply Current	$V_{IN} = 0, R_L = \infty$ $V_{DD} = 3.6V$	2.7	3.9	mA (max)
		$V_{IN} = 0, R_L = \infty$ $V_{DD} = 5V$	3.2	4.4	mA (max)
I_{DD}	Quiescent Power Supply Current	$V_{IN} = 0, V_{DD} = 3.6V$	2.7		mA
		$V_{IN} = 0, V_{DD} = 5V$	3.2		mA
I_{SD}	Shutdown Current	$V_{SD} = GND$	0.01	1.0	μA
V_{IH}	Logic Input High Voltage	\overline{SD} input, $V_{DD} = 3.6V$		1.4	V (min)
V_{IL}	Logic Input Low Voltage	\overline{SD} input, $V_{DD} = 3.6V$		0.4	V (max)
T_{WU}	Wake Up Time		7.5		ms
f_{SW}	Switching Frequency	SYNC_IN = V_{DD} (Spread Spectrum)	300 \pm 30		kHz
		SYNC_IN = GND (Fixed Frequency)	300		kHz
		SYNC_IN = External Clock Minimum Frequency	200		kHz
		SYNC_IN = External Clock Maximum Frequency	1000		kHz
A_V	Gain		12	11	dB (min)
				13	dB (max)
R_{IN}	Input Resistance		20	17	k Ω (min)

Symbol	Parameter	Conditions	LM48310		Units (Limits)
			Typical	Limit	
			(Note 6)	(Notes 7, 8)	
P _O	Output Power	R _L = 4Ω, THD = 10% f = 1kHz, 22kHz BW V _{DD} = 5V V _{DD} = 3.6V V _{DD} = 2.5V	2.6 1.3 555		W W mW
		R _L = 8Ω, THD = 10% (max) f = 1kHz, 22kHz BW V _{DD} = 5V V _{DD} = 3.6V V _{DD} = 2.5V	1.6 800 354		W mW mW
		R _L = 4Ω, THD = 1% (max) f = 1kHz, 22kHz BW V _{DD} = 5V V _{DD} = 3.6V V _{DD} = 2.5V	2.1 1 446		W W mW
		R _L = 8Ω, THD = 1% (max) f = 1kHz, 22kHz BW V _{DD} = 5V V _{DD} = 3.6V V _{DD} = 2.5V	1.3 640 286	1.1	W (min) mW mW
THD+N	Total Harmonic Distortion + Noise	P _O = 200mW, R _L = 8Ω, f = 1kHz	0.03		% (max)
		P _O = 100mW, R _L = 8Ω, f = 1kHz	0.03		%
PSRR	Power Supply Rejection Ratio (Input Referred)	V _{RIPPLE} = 200mV _{P-P} Sine, f _{RIPPLE} = 217Hz, Inputs AC GND, C _{IN} = 1μF, Input referred	82		dB
		V _{RIPPLE} = 200mV _{P-P} Sine, f _{RIPPLE} = 1kHz, Inputs AC GND, C _{IN} = 1μF, Input referred	80		dB
CMRR	Common Mode Rejection Ratio	V _{RIPPLE} = 1V _{P-P} f _{RIPPLE} = 217Hz	70		dB
η	Efficiency	V _{DD} = 5V, P _{OUT} = 1W R _L = 8Ω, f = 1kHz	88		%
		V _{DD} = 3.6V, P _{OUT} = 400mW R _L = 8Ω, f = 1kHz	85		%
SNR	Signal to Noise Ratio	V _{DD} = 5V, P _O = 1W, Fixed Frequency Mode	97		dB
		V _{DD} = 5V, P _O = 1W, Spread Spectrum Mode	97		dB
ε _{OS}	Output Noise	Input referred, Fixed Frequency Mode, A-weighted Filter	14		μV
		Input referred, Spread Spectrum Mode, Unweighted	28		μV

Note 1: "Absolute Maximum Ratings" indicate limits beyond which damage to the device may occur, including inoperability and degradation of device reliability and/or performance. Functional operation of the device and/or non-degradation at the *Absolute Maximum Ratings* or other conditions beyond those indicated in the *Recommended Operating Conditions* is not implied. The *Recommended Operating Conditions* indicate conditions at which the device is functional and the device should not be operated beyond such conditions. All voltages are measured with respect to the ground pin, unless otherwise specified.

Note 2: The *Electrical Characteristics* tables list guaranteed specifications under the listed *Recommended Operating Conditions* except as otherwise modified or specified by the *Electrical Characteristics Conditions* and/or Notes. Typical specifications are estimations only and are not guaranteed.

Note 3: The maximum power dissipation must be derated at elevated temperatures and is dictated by T_{JMAX} , θ_{JA} , and the ambient temperature, T_A . The maximum allowable power dissipation is $P_{DMAX} = (T_{JMAX} - T_A) / \theta_{JA}$ or the number given in *Absolute Maximum Ratings*, whichever is lower.

Note 4: Human body model, applicable std. JESD22-A114C.

Note 5: Machine model, applicable std. JESD22-A115-A.

Note 6: Typical values represent most likely parametric norms at $T_A = +25^\circ\text{C}$, and at the *Recommended Operation Conditions* at the time of product characterization and are not guaranteed.

Note 7: Datasheet min/max specification limits are guaranteed by test or statistical analysis.

Note 8: R_L is a resistive load in series with two inductors to simulate an actual speaker load. For $R_L = 8\Omega$, the load is $15\mu\text{H} + 8\Omega + 15\mu\text{H}$. For $R_L = 4\Omega$, the load is $15\mu\text{H} + 4\Omega + 15\mu\text{H}$.

Typical Performance Characteristics

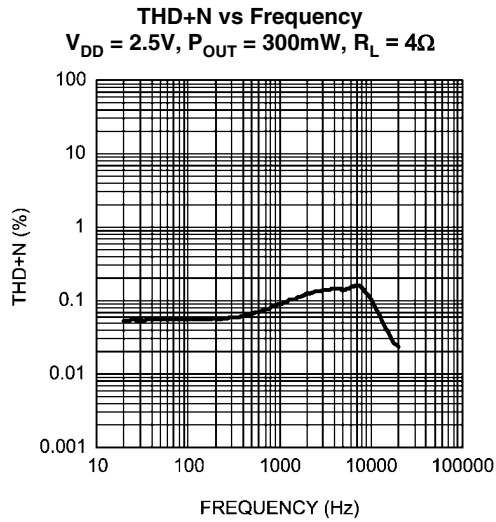

30037466

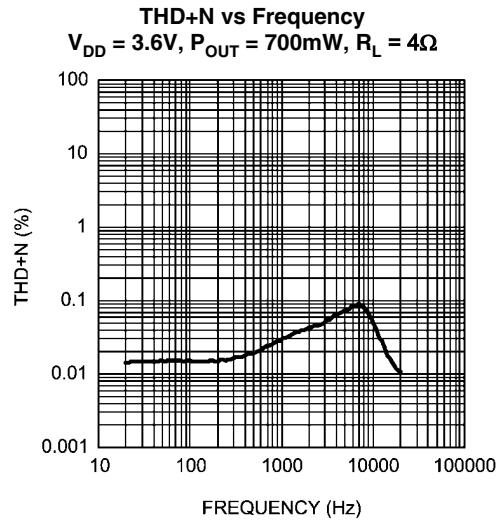

30037467

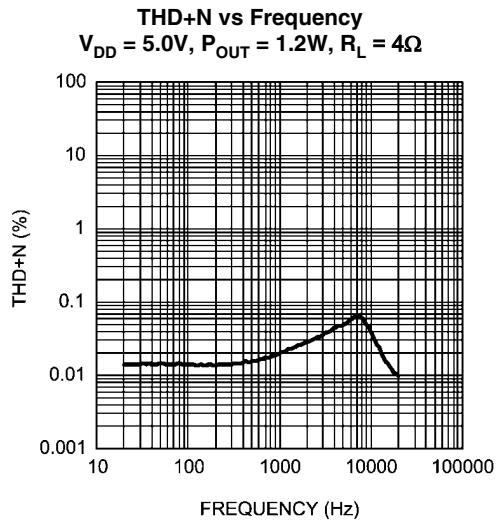

30037468

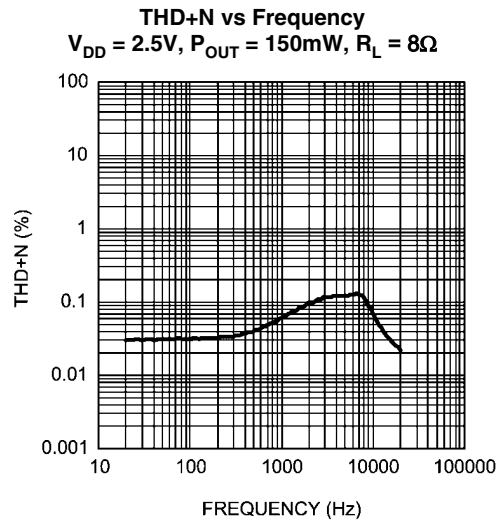

30037469

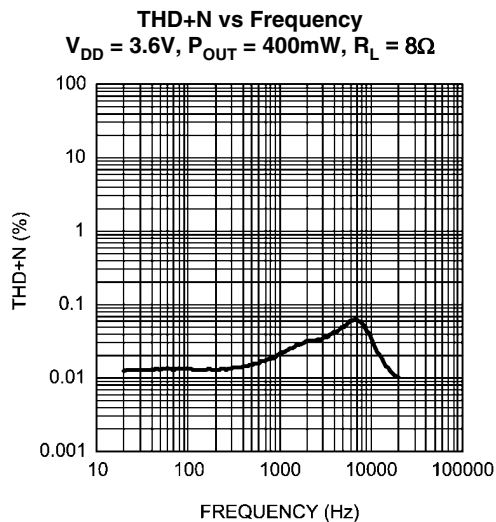

30037470

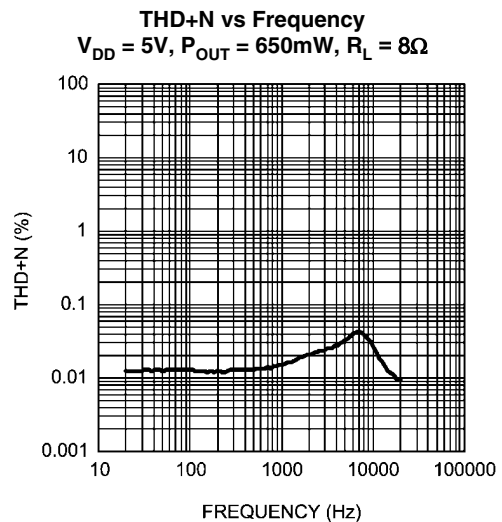

30037471

THD+N vs Output Power
 $f = 1\text{kHz}, R_L = 4\Omega$

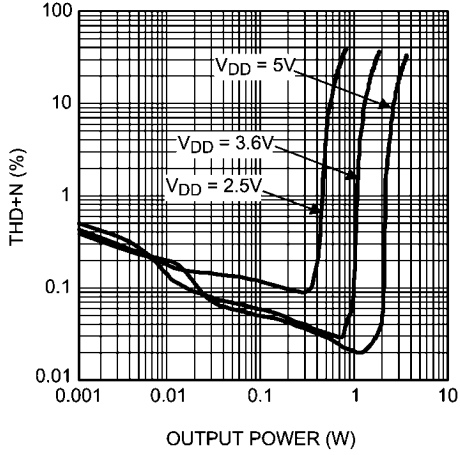

30037464

THD+N vs Output Power
 $f = 1\text{kHz}, R_L = 8\Omega$

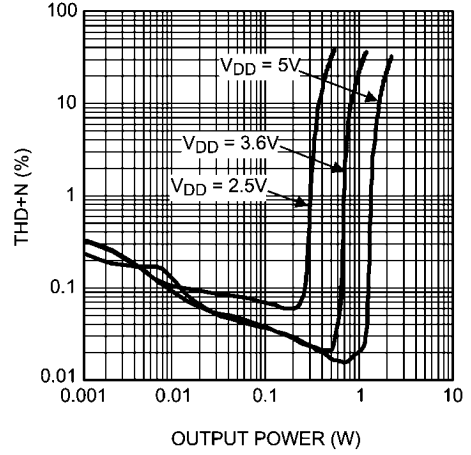

30037465

Efficiency vs Output Power
 $f = 1\text{kHz}, R_L = 4\Omega$

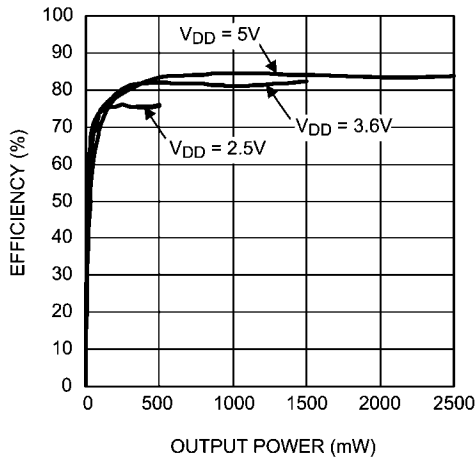

30037472

Efficiency vs Output Power
 $f = 1\text{kHz}, R_L = 8\Omega$

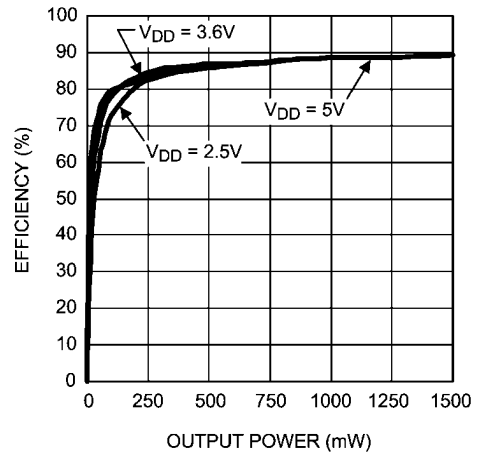

30037473

Power Dissipation vs Output Power
 $f = 1\text{kHz}, R_L = 4\Omega$

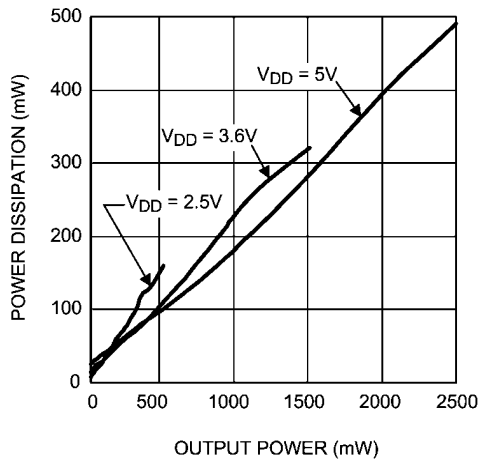

30037474

Power Dissipation vs Output Power
 $f = 1\text{kHz}, R_L = 8\Omega$

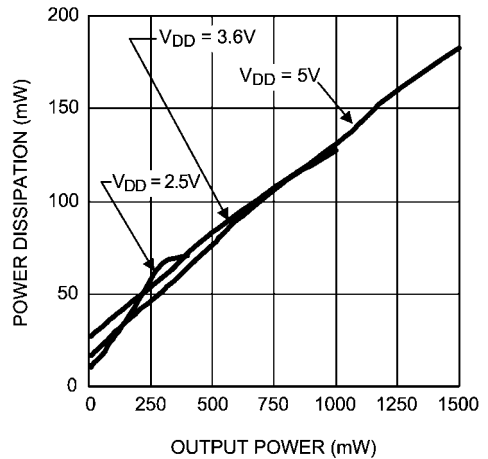

30037475

www.DataSheet4U.com
Output Power vs Supply Voltage
 $f = 1\text{kHz}, R_L = 4\Omega$

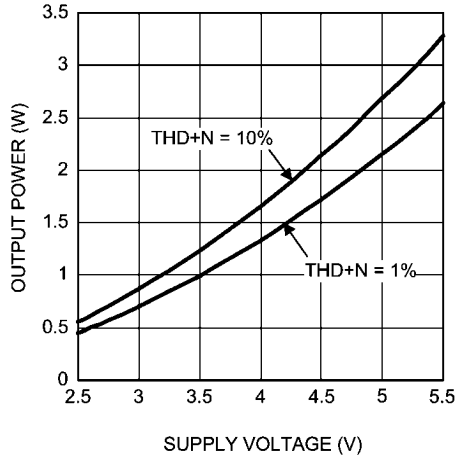

30037476

Output Power vs Supply Voltage
 $f = 1\text{kHz}, R_L = 8\Omega$

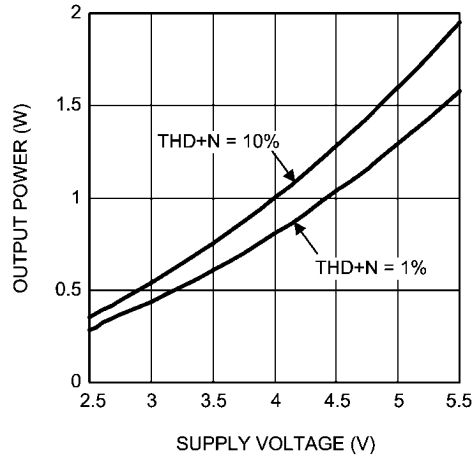

30037477

PSRR vs Frequency
 $V_{DD} = 3.6\text{V}, V_{RIPPLE} = 200\text{mV}_{P-P}, R_L = 8\Omega$

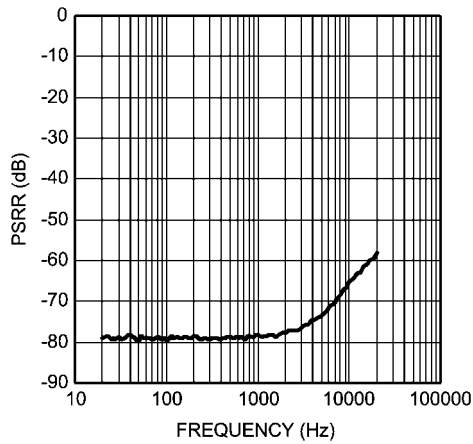

30037497

PSRR vs Frequency
 $V_{DD} = 5.0\text{V}, V_{RIPPLE} = 200\text{mV}_{P-P}, R_L = 8\Omega$

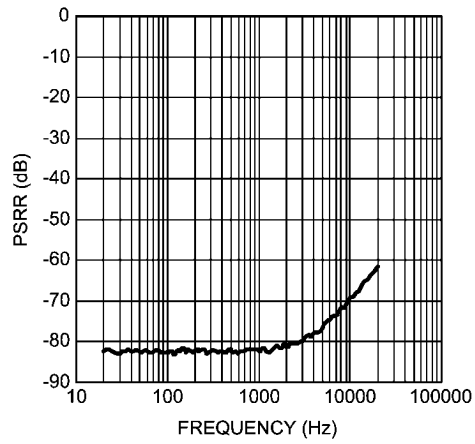

30037498

CMRR vs Frequency
 $V_{DD} = 3.6\text{V}, V_{RIPPLE} = 1\text{V}_{P-P}, R_L = 8\Omega$

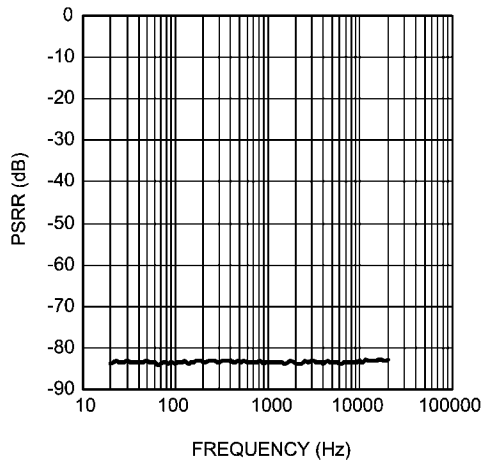

30037480

CMRR vs Frequency
 $V_{DD} = 5.0\text{V}, V_{RIPPLE} = 1\text{V}_{P-P}, R_L = 8\Omega$

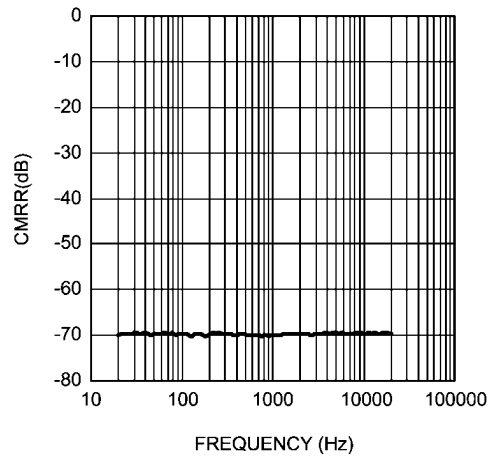

30037463

Fixed Frequency Output Spectrum vs Frequency
 $V_{DD} = 5.0V, V_{IN} = 1V_{RMS}, R_L = 8\Omega$

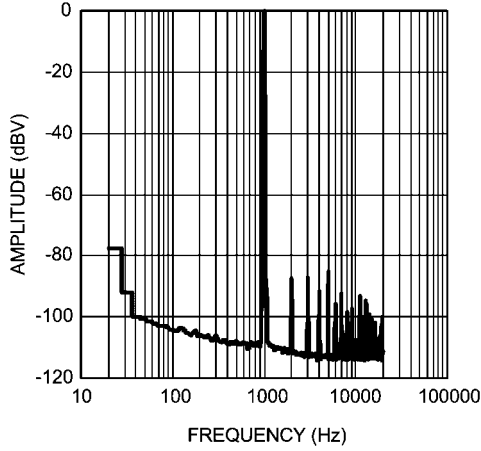

30037482

Spread Spectrum Output Spectrum vs Frequency
 $V_{DD} = 5.0V, V_{IN} = 1V_{RMS}, R_L = 8\Omega$

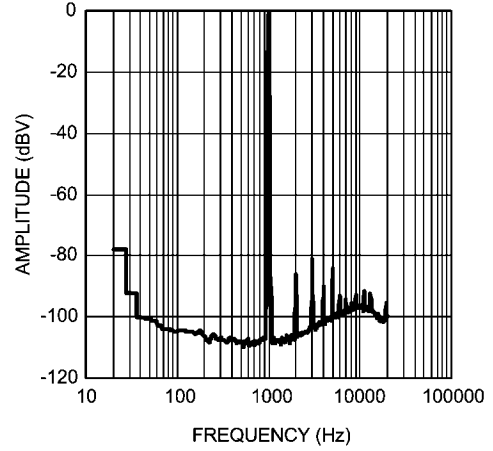

30037483

Wideband Fixed Frequency Output Spectrum vs Frequency
 $V_{DD} = 5.0V, R_L = 8\Omega$

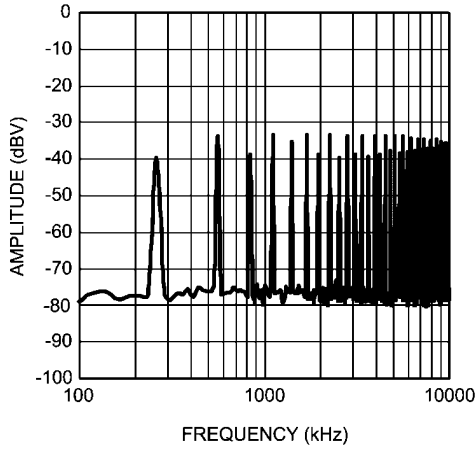

30037484

Wideband Spread Spectrum Output Spectrum vs Frequency
 $V_{DD} = 5.0V, R_L = 8\Omega$

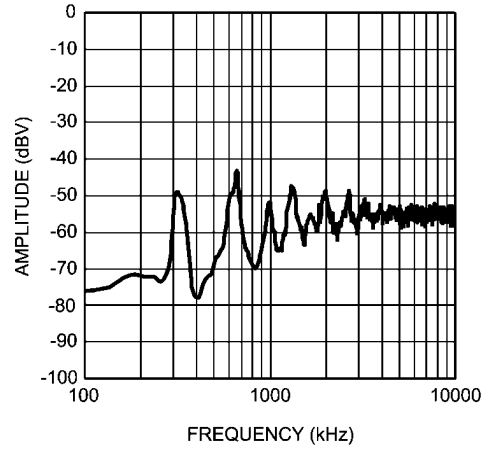

30037485

Supply Current vs Supply Voltage No Load

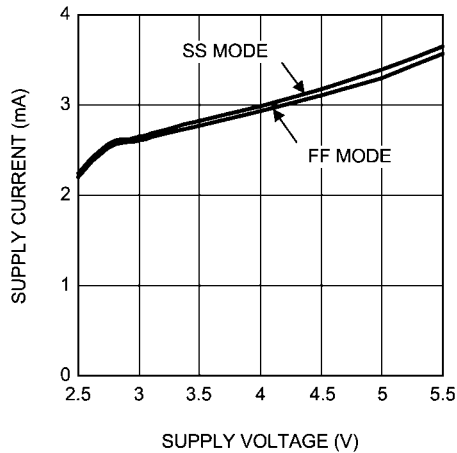

30037486

Shutdown Supply Current vs Supply Voltage No Load

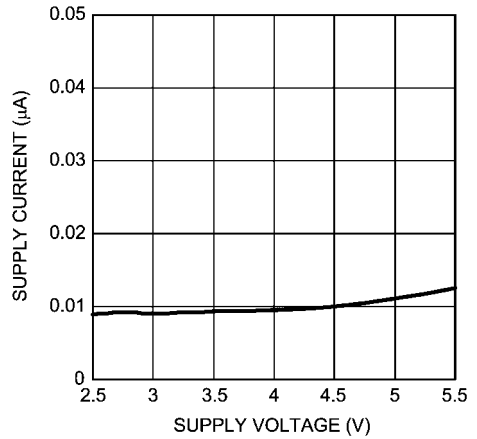

30037499

Application Information

GENERAL AMPLIFIER FUNCTION

The LM48310 mono Class D audio power amplifier features a filterless modulation scheme that reduces external component count, conserving board space and reducing system cost. With no signal applied, the outputs (V_{OUTA} and V_{OUTB}) switch between V_{DD} and GND with a 50% duty cycle, in phase, causing the two outputs to cancel. This cancellation results in no net voltage across the speaker, thus there is no current to the load in the idle state.

With the input signal applied, the duty cycle (pulse width) of the LM48310 outputs changes. For increasing output voltage, the duty cycle of V_{OUTA} increases, while the duty cycle of V_{OUTB} decreases. For decreasing output voltages, the converse occurs. The difference between the two pulse widths yields the differential output voltage.

ENHANCED EMISSIONS SUPPRESSION SYSTEM (E²S)

The LM48310 features National's patent-pending E²S system that reduces EMI, while maintaining high quality audio reproduction and efficiency. The E²S system features a synchronizable oscillator with selectable spread spectrum, and advanced edge rate control (ERC). The LM48310 ERC greatly reduces the high frequency components of the output square waves by controlling the output rise and fall times, slowing the transitions to reduce RF emissions, while maximizing THD+N and efficiency performance. The overall result of the E²S system is a filterless Class D amplifier that passes FCC Class B radiated emissions standards with 20in of twisted pair cable, with excellent 0.03% THD+N and high 88% efficiency.

FIXED FREQUENCY MODE (SYNC_IN = GND)

The LM48310 features two modulations schemes, a fixed frequency mode and a spread spectrum mode. Select the fixed frequency mode by setting SYNC_IN = GND. In fixed frequency mode, the amplifier output switch at a constant 300kHz. In fixed frequency mode, the output spectrum consists of the fundamental and its associated harmonics (see *Typical Performance Characteristics*).

SPREAD SPECTRUM MODE (SYNC_IN = V_{DD})

The logic selectable spread spectrum mode eliminates the need for output filters, ferrite beads or chokes. In spread

spectrum mode, the switching frequency varies randomly by 30% about a 300kHz center frequency, reducing the wide-band spectral content, improving EMI emissions radiated by the speaker and associated cables and traces. Where a fixed frequency class D exhibits large amounts of spectral energy at multiples of the switching frequency, the spread spectrum architecture of the LM48310 spreads that energy over a larger bandwidth (See *Typical Performance Characteristics*). The cycle-to-cycle variation of the switching period does not affect the audio reproduction, efficiency, or PSRR. Set SYNC_IN = V_{DD} for spread spectrum mode.

EXTERNAL CLOCK MODE (SYNC_IN = CLOCK)

Connecting a clock signal to SYNC_IN synchronizes the LM48310 oscillator to an external clock, moving the output spectral components out of a sensitive frequency band, and minimizing audible beat frequencies when multiple LM48310s are used in a single system. The LM48310 accepts an external clock frequency between 200kHz and 1MHz. The LM48310 can be synchronized to a spread spectrum clock, allowing multiple LM48310s to be synchronized in spread spectrum mode (see SYNC_OUT section).

SYNC_OUT

SYNC_OUT is a clock output for synchronizing external devices. The SYNC_OUT signal is identical in frequency and duty cycle of the amplifier's switching frequency. When the LM48310 is in fixed frequency mode, SYNC_OUT is a fixed, 300kHz clock. When the LM48310 is in spread spectrum mode, SYNC_OUT is an identical spread spectrum clock. When the LM48310 is driven by an external clock, SYNC_OUT is identical to the external clock. If unused, leave SYNC_OUT floating.

Multiple LM48310s can be synchronized to a single clock. In Figure 2, device U1 is the master, providing a spread spectrum clock to the slave device (U2). This configuration synchronizes the switching frequencies of the two devices, eliminating any audible beat frequencies. Because SYNC_OUT has no audio content, there is minimal THD+N degradation or crosstalk between the devices, Figure 3-5.

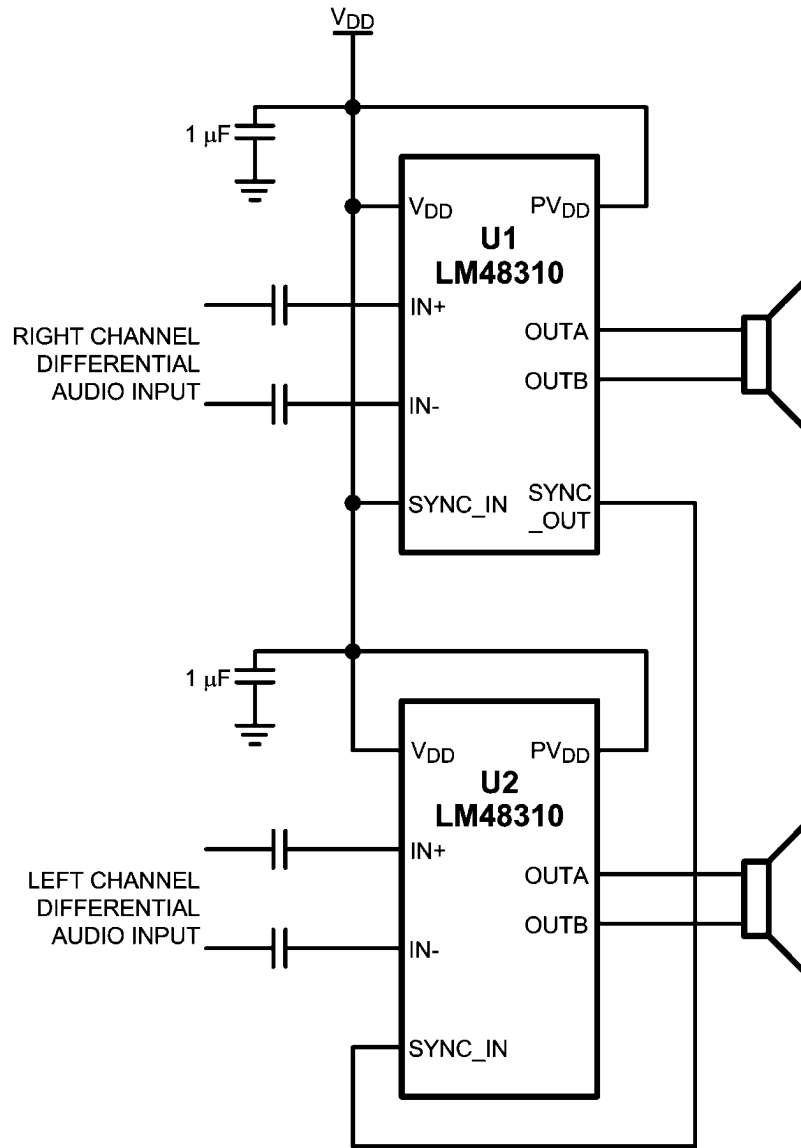

30037460

FIGURE 2. Cascaded LM48310

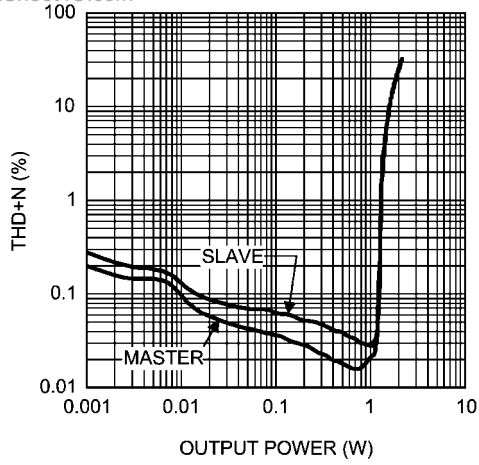

FIGURE 3. THD+N vs Output Power

300374a1

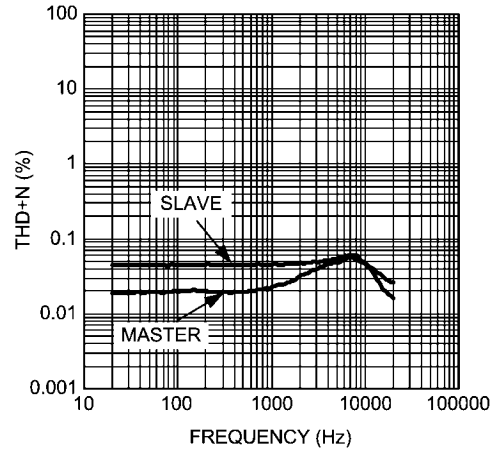

FIGURE 4. THD+N vs Frequency

30037438

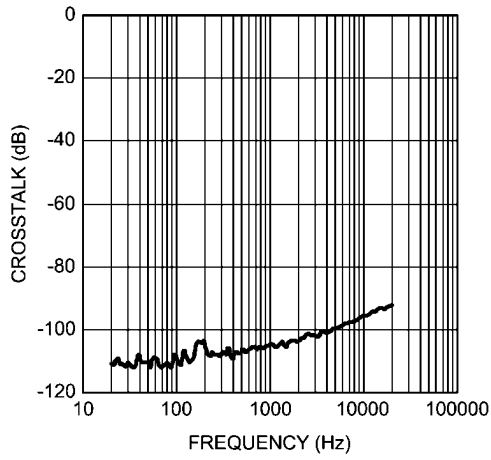

FIGURE 5. Crosstalk vs Frequency

30037496

DIFFERENTIAL AMPLIFIER EXPLANATION

As logic supplies continue to shrink, system designers are increasingly turning to differential analog signal handling to preserve signal to noise ratios with restricted voltage signs. The LM48310 features a fully differential speaker amplifier. A differential amplifier amplifies the difference between the two input signals. Traditional audio power amplifiers have typically offered only single-ended inputs resulting in a 6dB reduction of SNR relative to differential inputs. The LM48310 also offers the possibility of DC input coupling which eliminates the input coupling capacitors. A major benefit of the fully differential amplifier is the improved common mode rejection ratio (CMRR) over single ended input amplifiers. The increased CMRR of the differential amplifier reduces sensitivity to ground offset related noise injection, especially important in noisy systems.

POWER DISSIPATION AND EFFICIENCY

The major benefit of a Class D amplifier is increased efficiency versus a Class AB. The efficiency of the LM48310 is attributed to the region of operation of the transistors in the output stage. The Class D output stage acts as current steering switches, consuming negligible amounts of power compared to their Class AB counterparts. Most of the power loss associated with the output stage is due to the IR loss of the MOSFET on-resistance, along with switching losses due to gate charge.

SHUTDOWN FUNCTION

The LM48310 features a low current shutdown mode. Set $\overline{SD} = \text{GND}$ to disable the amplifier and reduce supply current to 0.01 μA .

Switch \overline{SD} between GND and V_{DD} for minimum current consumption is shutdown. The LM48310 may be disabled with shutdown voltages in between GND and V_{DD} , the idle current will be greater than the typical 0.1 μA value.

The LM48310 shutdown input has an internal pulldown resistor. The purpose of this resistor is to eliminate any unwanted state changes when \overline{SD} is floating. To minimize shutdown current, \overline{SD} should be driven to GND or left floating. If \overline{SD} is not driven to GND or floating, an increase in shutdown supply current will be noticed.

AUDIO AMPLIFIER POWER SUPPLY BYPASSING/FILTERING

Proper power supply bypassing is critical for low noise performance and high PSRR. Place the supply bypass capacitors as close to the device as possible. Typical applications employ a voltage regulator with 10 μF and 0.1 μF bypass capacitors that increase supply stability. These capacitors do not eliminate the need for bypassing of the LM48310 supply pins. A 1 μF capacitor is recommended.

AUDIO AMPLIFIER INPUT CAPACITOR SELECTION

Input capacitors may be required for some applications, or when the audio source is single-ended. Input capacitors block the DC component of the audio signal, eliminating any conflict between the DC component of the audio source and the bias voltage of the LM48310. The input capacitors create a high-pass filter with the input resistors R_{IN} . The -3dB point of the high pass filter is found using Equation (1) below.

$$f = 1 / 2\pi R_{IN} C_{IN}$$

Where R_{IN} is the value of the input resistor given in the *Electrical Characteristics* table.

The input capacitors can also be used to remove low frequency content from the audio signal. Small speakers cannot reproduce, and may even be damaged by low frequencies. High pass filtering the audio signal helps protect the speakers. When the LM48310 is using a single-ended source, power supply noise on the ground is seen as an input signal. Setting the high-pass filter point above the power supply noise frequencies, 217Hz in a GSM phone, for example, filters out the noise such that it is not amplified and heard on the output. Capacitors with a tolerance of 10% or better are recommended for impedance matching and improved CMRR and PSRR.

AUDIO AMPLIFIER GAIN

The gain of the LM48310 is internally set to 12dB. The gain can be reduced by adding additional input resistance (Figure 6). In this configuration, the gain of the device is given by:

$$A_V = 2 \times [R_F / (R_{INEXT} + R_{IN})]$$

Where R_F is 40k Ω , R_{IN} is 20k Ω , and R_{INEXT} is the value of the additional external resistor.

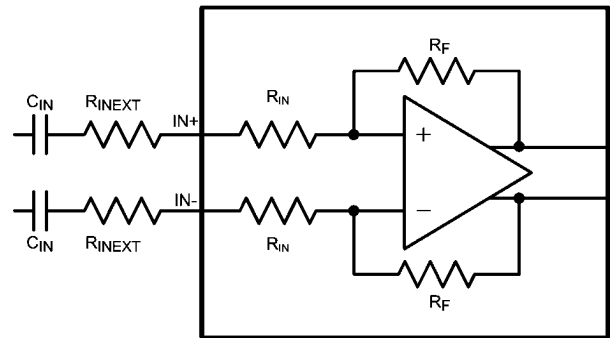

FIGURE 6. Reduced Gain Configuration

30037461

SINGLE-ENDED AUDIO AMPLIFIER CONFIGURATION

The LM48310 is compatible with single-ended sources. When configured for single-ended inputs, input capacitors must be used to block and DC component at the input of the device. Figure 7 shows the typical single-ended applications circuit.

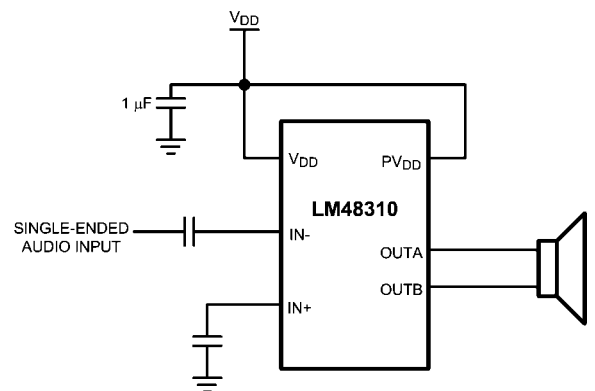

FIGURE 7. Single-Ended Input Configuration

30037462

PCB LAYOUT GUIDELINES

As output power increases, interconnect resistance (PCB traces and wires) between the amplifier, load and power supply create a voltage drop. The voltage loss due to the traces between the LM48310 and the load results in lower output power and decreased efficiency. Higher trace resistance between the supply and the LM48310 has the same effect as a poorly regulated supply, increasing ripple on the supply line, and reducing peak output power. The effects of residual trace resistance increases as output current increases due to higher output power, decreased load impedance or both. To maintain the highest output voltage swing and corresponding peak output power, the PCB traces that connect the output pins to the load and the supply pins to the power supply should be as wide as possible to minimize trace resistance.

The use of power and ground planes will give the best THD +N performance. In addition to reducing trace resistance, the use of power planes creates parasitic capacitors that help to filter the power supply line.

The inductive nature of the transducer load can also result in overshoot on one of both edges, clamped by the parasitic diodes to GND and V_{DD} in each case. From an EMI standpoint, this is an aggressive waveform that can radiate or conduct to other components in the system and cause interference. It is essential to keep the power and output traces short and well shielded if possible. Use of ground planes, beads and micro-strip layout techniques are all useful in preventing unwanted interference.

As the distance from the LM48310 and the speaker increases, the amount of EMI radiation increases due to the output wires or traces acting as antennas become more efficient with length. Ferrite chip inductors placed close to the LM48310 outputs may be needed to reduce EMI radiation.

Designator	Quantity	Description
C1	1	10 μ F \pm 10% 16V 500 Ω Tantalum Capacitor (B Case) AVX TPSB106K016R0500
C2, C3	2	1 μ F \pm 10% 16V X7R Ceramic Capacitor (603) Panasonic ECJ-1VB1C105K
C4, C5	2	1 μ F \pm 10% 16V X7R Ceramic Capacitor (1206) Panasonic ECJ-3YB1C105K
C6	1	Not Installed Ceramic Capacitor (603)
R1	1	0 Ω \pm 1% resistor (603)
JP1 — JP2	2	3 Pin Headers
LM48310SDL	1	LM48310SD (10-pin LLP)

LM48310 Demo Board Schematic

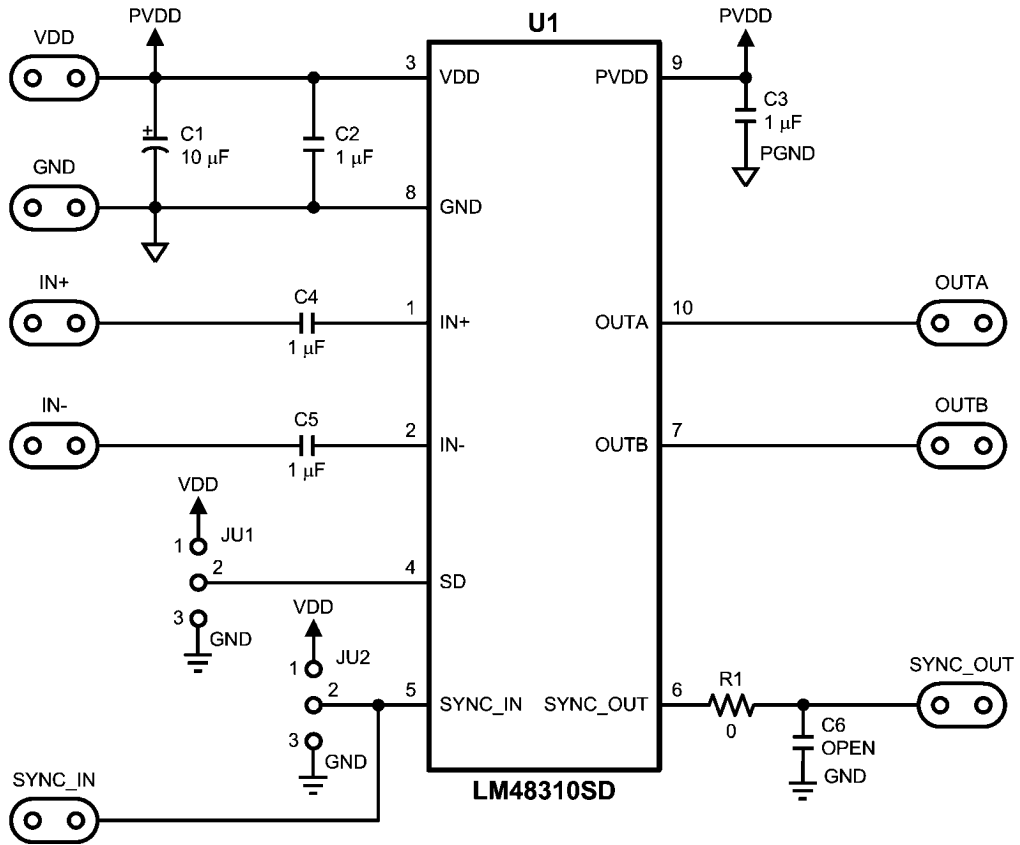

FIGURE 8. LM48310 DEMO BOARD SCHEMATIC

30037489

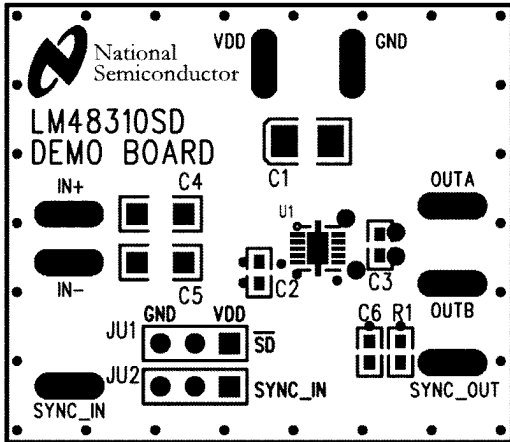

FIGURE 9. Top Silkscreen

30037490

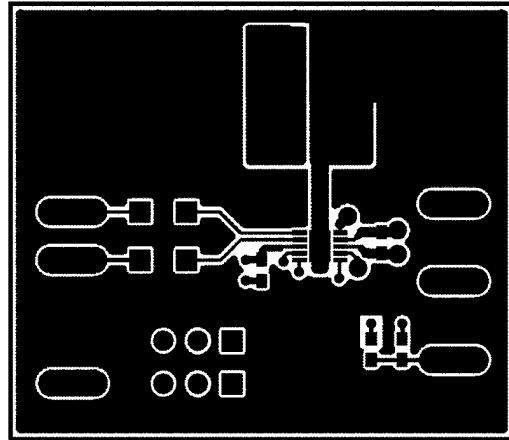

FIGURE 10. Top Layer

30037491

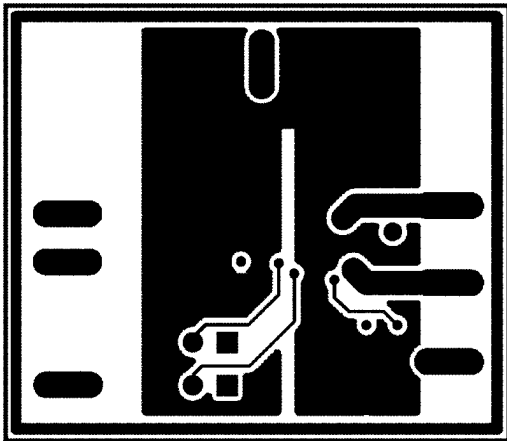

FIGURE 11. Layer 2 (GND)

30037492

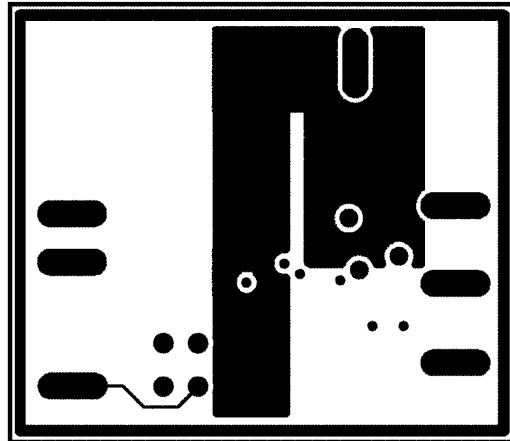

FIGURE 12. Layer 3 (V_{DD})

30037493

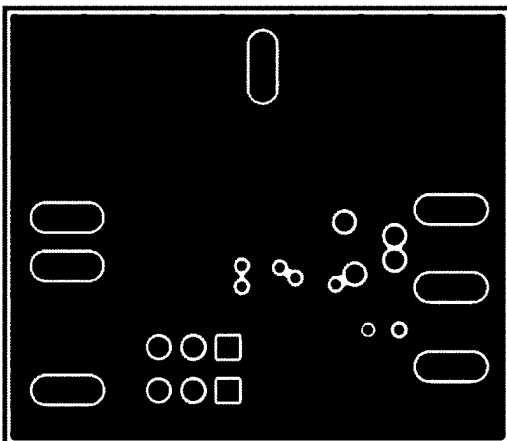

FIGURE 13. Bottom Layer

30037494

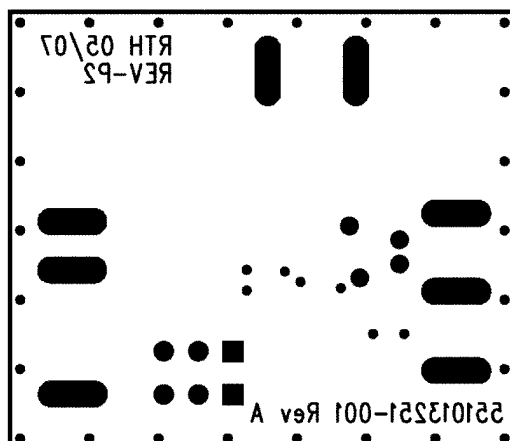

FIGURE 14. Bottom Silkscreen

30037495

Revision History

Rev	Date	Description
1.0	11/13/07	Initial release.
1.01	02/26/08	Fixed few typos (Pin Description table).
1.02	03/04/08	Text edits under SHUTDOWN FUNCTION (Application Information section).

Physical Dimensions inches (millimeters) unless otherwise noted

www.DataSheet4U.com

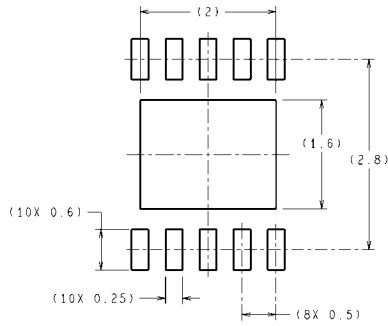

RECOMMENDED LAND PATTERN

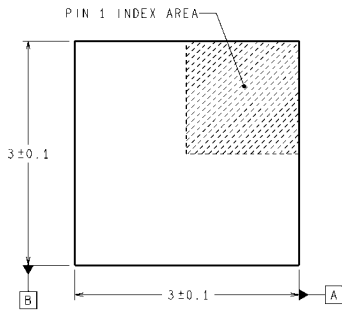

DIMENSIONS ARE IN MILLIMETERS
DIMENSIONS IN () FOR REFERENCE ONLY

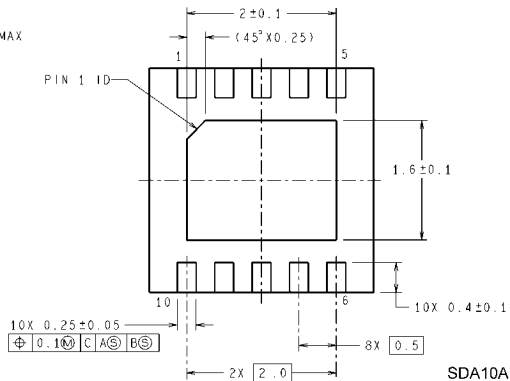
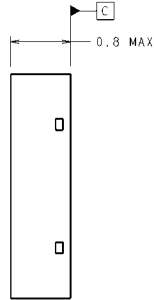
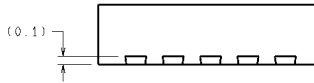

SDA10A (Rev A)

LLP
Order Number LM48310SD
NS Package Number SDA08A

Notes

For more National Semiconductor product information and proven design tools, visit the following Web sites at:

Products		Design Support	
Amplifiers	www.national.com/amplifiers	WEBENCH	www.national.com/webench
Audio	www.national.com/audio	Analog University	www.national.com/AU
Clock Conditioners	www.national.com/timing	App Notes	www.national.com/appnotes
Data Converters	www.national.com/adc	Distributors	www.national.com/contacts
Displays	www.national.com/displays	Green Compliance	www.national.com/quality/green
Ethernet	www.national.com/ethernet	Packaging	www.national.com/packaging
Interface	www.national.com/interface	Quality and Reliability	www.national.com/quality
LVDS	www.national.com/lvds	Reference Designs	www.national.com/refdesigns
Power Management	www.national.com/power	Feedback	www.national.com/feedback
Switching Regulators	www.national.com/switchers		
LDOs	www.national.com/lido		
LED Lighting	www.national.com/led		
PowerWise	www.national.com/powerwise		
Serial Digital Interface (SDI)	www.national.com/sdi		
Temperature Sensors	www.national.com/tempsensors		
Wireless (PLL/VCO)	www.national.com/wireless		

THE CONTENTS OF THIS DOCUMENT ARE PROVIDED IN CONNECTION WITH NATIONAL SEMICONDUCTOR CORPORATION ("NATIONAL") PRODUCTS. NATIONAL MAKES NO REPRESENTATIONS OR WARRANTIES WITH RESPECT TO THE ACCURACY OR COMPLETENESS OF THE CONTENTS OF THIS PUBLICATION AND RESERVES THE RIGHT TO MAKE CHANGES TO SPECIFICATIONS AND PRODUCT DESCRIPTIONS AT ANY TIME WITHOUT NOTICE. NO LICENSE, WHETHER EXPRESS, IMPLIED, ARISING BY ESTOPPEL OR OTHERWISE, TO ANY INTELLECTUAL PROPERTY RIGHTS IS GRANTED BY THIS DOCUMENT.

TESTING AND OTHER QUALITY CONTROLS ARE USED TO THE EXTENT NATIONAL DEEMS NECESSARY TO SUPPORT NATIONAL'S PRODUCT WARRANTY. EXCEPT WHERE MANDATED BY GOVERNMENT REQUIREMENTS, TESTING OF ALL PARAMETERS OF EACH PRODUCT IS NOT NECESSARILY PERFORMED. NATIONAL ASSUMES NO LIABILITY FOR APPLICATIONS ASSISTANCE OR BUYER PRODUCT DESIGN. BUYERS ARE RESPONSIBLE FOR THEIR PRODUCTS AND APPLICATIONS USING NATIONAL COMPONENTS. PRIOR TO USING OR DISTRIBUTING ANY PRODUCTS THAT INCLUDE NATIONAL COMPONENTS, BUYERS SHOULD PROVIDE ADEQUATE DESIGN, TESTING AND OPERATING SAFEGUARDS.

EXCEPT AS PROVIDED IN NATIONAL'S TERMS AND CONDITIONS OF SALE FOR SUCH PRODUCTS, NATIONAL ASSUMES NO LIABILITY WHATSOEVER, AND NATIONAL DISCLAIMS ANY EXPRESS OR IMPLIED WARRANTY RELATING TO THE SALE AND/OR USE OF NATIONAL PRODUCTS INCLUDING LIABILITY OR WARRANTIES RELATING TO FITNESS FOR A PARTICULAR PURPOSE, MERCHANTABILITY, OR INFRINGEMENT OF ANY PATENT, COPYRIGHT OR OTHER INTELLECTUAL PROPERTY RIGHT.

LIFE SUPPORT POLICY

NATIONAL'S PRODUCTS ARE NOT AUTHORIZED FOR USE AS CRITICAL COMPONENTS IN LIFE SUPPORT DEVICES OR SYSTEMS WITHOUT THE EXPRESS PRIOR WRITTEN APPROVAL OF THE CHIEF EXECUTIVE OFFICER AND GENERAL COUNSEL OF NATIONAL SEMICONDUCTOR CORPORATION. As used herein:

Life support devices or systems are devices which (a) are intended for surgical implant into the body, or (b) support or sustain life and whose failure to perform when properly used in accordance with instructions for use provided in the labeling can be reasonably expected to result in a significant injury to the user. A critical component is any component in a life support device or system whose failure to perform can be reasonably expected to cause the failure of the life support device or system or to affect its safety or effectiveness.

National Semiconductor and the National Semiconductor logo are registered trademarks of National Semiconductor Corporation. All other brand or product names may be trademarks or registered trademarks of their respective holders.

Copyright© 2008 National Semiconductor Corporation

For the most current product information visit us at www.national.com



**National Semiconductor
Americas Technical
Support Center**
Email:
new.feedback@nsc.com
Tel: 1-800-272-9959

**National Semiconductor Europe
Technical Support Center**
Email: europe.support@nsc.com
German Tel: +49 (0) 180 5010 771
English Tel: +44 (0) 870 850 4288

**National Semiconductor Asia
Pacific Technical Support Center**
Email: ap.support@nsc.com

**National Semiconductor Japan
Technical Support Center**
Email: jpn.feedback@nsc.com