

# LM4844 Boomer<sup>®</sup> Audio Power Amplifier Series

## Stereo 1.2W Audio Sub-System with 3D Enhancement

### General Description

The LM4844 is an integrated audio sub-system designed for stereo cell phone applications. Operating on a 3.3V supply, it combines a stereo speaker amplifier delivering 495mW per channel into an 8Ω load and a stereo OCL headphone amplifier delivering 33mW per channel into a 32Ω load.

It integrates the audio amplifiers, volume control, mixer, power management control, and National 3D enhancement all into a single package. In addition, the LM4844 routes and mixes the stereo and mono inputs into 10 distinct output modes. The LM4844 is controlled through an I<sup>2</sup>C compatible interface.

Boomer audio power amplifiers are designed specifically to provide high quality output power with a minimal amount of external components.

The LM4844 is available in a very small 2.5mm x 2.9mm 30-bump micro SMD (TL) package.

### Key Specifications

■ P <sub>OUT</sub> , Stereo BTL, 8Ω, 3.3V, 1% THD+N	495mW (typ)
■ P <sub>OUT</sub> HP, 32Ω, 3.3V, 1% THD+N	33mW (typ)
■ Shutdown Current, 3.3V	0.1μA (typ)

### Features

- Stereo speaker amplifier
- Stereo OCL headphone amplifier
- Independent Left, Right, and Mono volume controls
- National 3D enhancement
- I<sup>2</sup>C compatible interface
- Ultra low shutdown current
- Click and Pop Suppression circuit
- 10 distinct output modes

### Applications

- Cell Phones
- PDAs
- Portable Gaming Devices
- Internet Appliances
- Portable DVD, CD, AAC, and MP3 Players

# Block Diagram

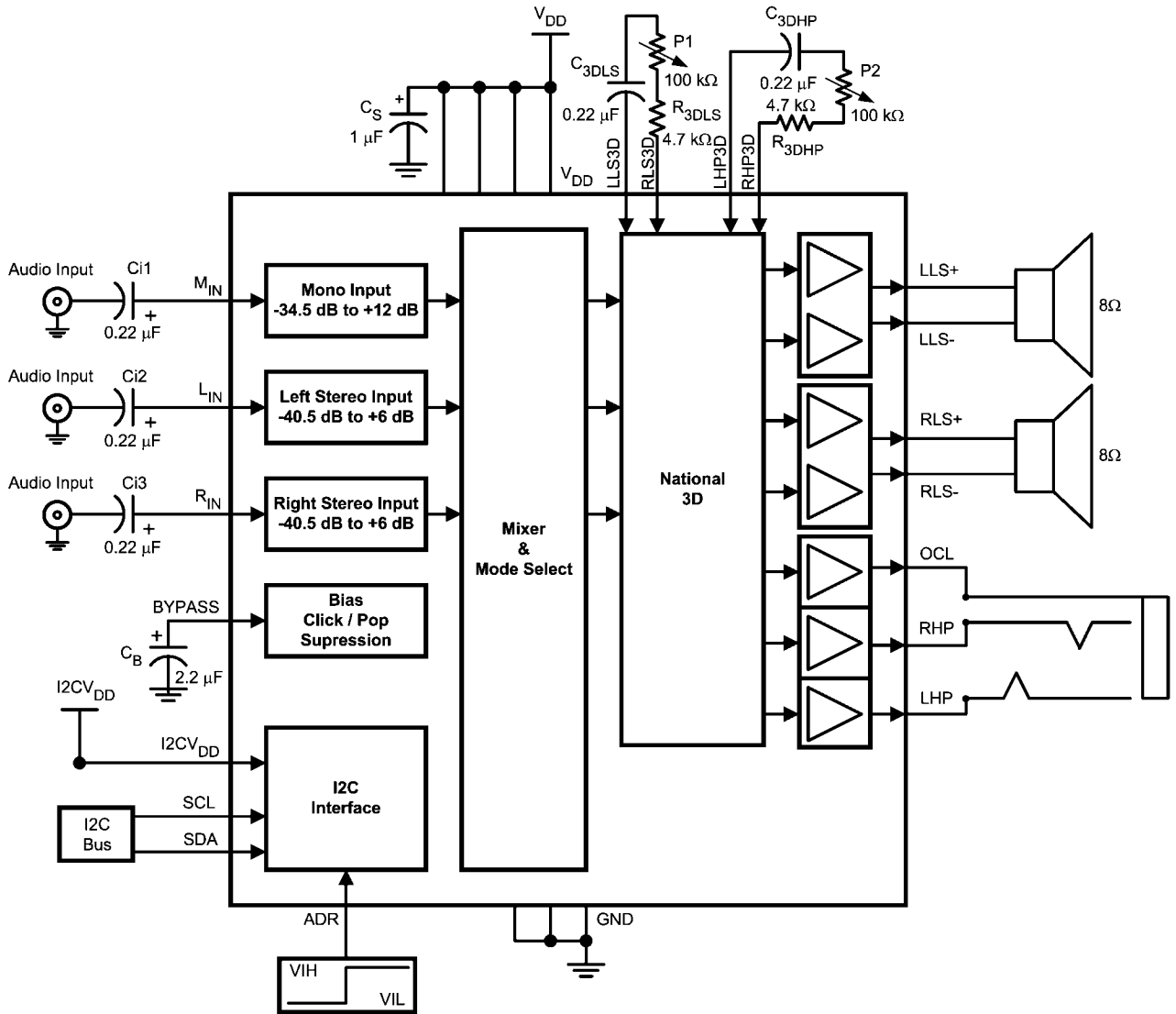
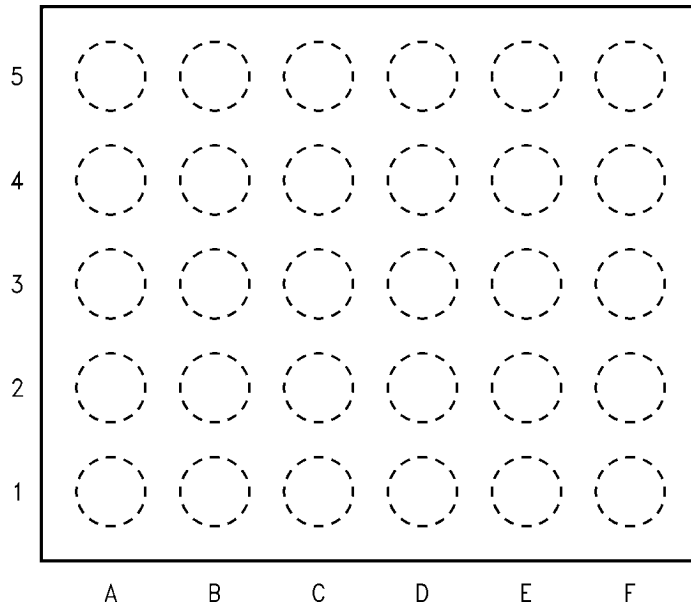

FIGURE 1. Audio Sub-System Block Diagram

20153531

# Connection Diagrams

30 Bump Micro SMD (TL) Package



20153508

**Top View**  
**(Bump-side down)**  
**Order Number LM4844TL**  
**See NS Package Number TLA30CZA**

Micro SMD (TL) Marking

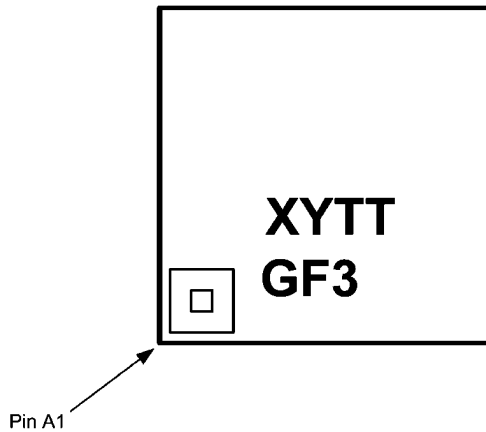

20153592

**Top View**  
**XY = 2 Digit Date Code**  
**TT = Die Traceability**  
**G = Boomer Family**  
**F3 = LM4844TL**

## Pin Connection (TL)

Pin	Name	Pin Description
A1	RLS+	Right Loudspeaker Positive Output
A2	V <sub>DD</sub>	Power Supply
A3	SDA	Data
A4	RHP3D	Right Headphone 3D
A5	RHP	Right Headphone Output
B1	GND	Ground
B2	I <sup>2</sup> C V <sub>DD</sub>	I <sup>2</sup> C Interface Power Supply
B3	ADR	I <sup>2</sup> C Address Select
B4	LHP3D	Left Headphone 3D
B5	V <sub>DD</sub>	Power Supply
C1	RLS-	Right Loudspeaker Negative Output
C2	NC	No Connect
C3	SCL	Clock
C4	NC	No Connect
C5	GND	Ground
D1	LLS-	Left Loudspeaker Negative Output
D2	V <sub>DD</sub>	Power Supply
D3	M <sub>IN</sub>	Mono Input
D4	NC	No Connect
D5	OCL	V <sub>DD</sub> /2 Supply for headphone jack's sleeve
E1	GND	Ground
E2	BYPASS	Half-supply bypass
E3	LLS3D	Left Loudspeaker 3D
E4	R <sub>IN</sub>	Right Stereo Input
E5	NC	No Connect
F1	LLS+	Left Loudspeaker Positive Output
F2	V <sub>DD</sub>	Power Supply
F3	RLS3D	Right Loudspeaker 3D
F4	L <sub>IN</sub>	Left Stereo Input
F5	LHP	Left Headphone Output

**Absolute Maximum Ratings** (Notes 1, 2)

If Military/Aerospace specified devices are required, please contact the National Semiconductor Sales Office/Distributors for availability and specifications.

Supply Voltage	6.0V
Storage Temperature	-65°C to +150°C
Input Voltage	-0.3V to $V_{DD} + 0.3V$
Power Dissipation (Note 3)	Internally Limited
ESD Susceptibility (Note 4)	2000V
ESD Susceptibility (Note 5)	200V
Junction Temperature ( $T_J$ )	150°C

Thermal Resistance

 $\theta_{JA}$  (TLA30CZA)

62°C/W

www.DataSheet4U.com

**Operating Ratings**

Temperature Range

 $T_{MIN} \leq T_A \leq T_{MAX}$  $-40^\circ\text{C} \leq T_A \leq +85^\circ\text{C}$ Supply Voltage ( $V_{DD}$ ) $2.7V \leq V_{DD} \leq 5.5V$ Supply Voltage ( $I^2CV_{DD}$ ) (Note 10) $I^2CV_{DD} \leq V_{DD}$  $1.7V \leq I^2CV_{DD} \leq 5.5V$ **Audio Amplifier Electrical Characteristics  $V_{DD} = 5.0V$**  (Notes 1, 2)

The following specifications apply for  $V_{DD} = 5.0V$ , unless otherwise specified. Limits apply for  $T_A = 25^\circ\text{C}$ .

Symbol	Parameter	Conditions	LM4844		Units (Limits)
			Typical (Note 6)	Limits (Notes 7, 8)	
$I_{DD}$	Supply Current	$V_{IN} = 0V$ , No load; LD5 = RD5 = 0			
		Mode 4, 9, 14	5	8	mA (max)
		Mode 2, 7, 12	12	18	mA (max)
		Mode 3, 8, 13	13	20	mA (max)
$I_{SD}$	Shutdown Current	Mode 0	0.2	2.5	$\mu\text{A}$ (max)
$P_O$	Output Power	Speaker; THD+N = 1%; $f = 1\text{kHz}$ ; 8 $\Omega$ BTL	1.2	0.9	W (min)
		Headphone; THD+N = 1%; $f = 1\text{kHz}$ ; 32 $\Omega$ SE	80	60	mW (min)
THD+N	Total Harmonic Distortion Plus Noise	LD5 = RD5 = 0			
		Speaker; $P_O = 400\text{mW}$ ; $f = 1\text{kHz}$ ; 8 $\Omega$ BTL	0.05		%
		Headphone; $P_O = 15\text{mW}$ ; $f = 1\text{kHz}$ ; 32 $\Omega$ SE	0.06		%
$V_{OS}$	Offset Voltage	Speaker; LD5 = RD5 = 0	5	40	mV (max)
		Headphone; LD5 = RD5 = 0	2	30	mV (max)
$N_{OUT}$	Output Noise	A-weighted, 0dB gain; LD5 = RD5 = 0			
		Speaker; Mode 2, 3, 7, 8	31		$\mu\text{V}$
		Speaker; Mode 12, 13	35		$\mu\text{V}$
		Headphone; Mode 3, 4, 8, 9	12		$\mu\text{V}$
		Headphone; Mode 13, 14	14		$\mu\text{V}$
PSRR	Power Supply Rejection Ratio	$f = 217\text{Hz}$ ; $V_{rip} = 200\text{mV}_{pp}$ ; $C_B = 2.2\mu\text{F}$ ; 0dB Gain Setting; LD5 = RD5 = 0			
		Speaker; Mode 2, 3, 7, 8	71		dB
		Speaker; Mode 12, 13,	65	55	dB (min)
		Headphone; Mode 3, 4, 8, 9	76		dB
		Headphone; Mode 13, 14	72	62	dB (min)
Xtalk	Crosstalk	LD5 = RD5 = 0			
		Loudspeaker; $P_O = 400\text{mW}$ ; $f = 1\text{kHz}$	84		dB
		Headphone; $P_O = 15\text{mW}$ ; $f = 1\text{kHz}$	60		dB
$T_{WU}$	Wake-up Time	CD4 = 0; $C_B = 2.2\mu\text{F}$	103		ms
		CD4 = 1; $C_B = 2.2\mu\text{F}$	42		ms

## Audio Amplifier Electrical Characteristics $V_{DD} = 3.0V$ (Notes 1, 2) [www.DataSheet4U.com](http://www.DataSheet4U.com)

The following specifications apply for  $V_{DD} = 3.0V$ , unless otherwise specified. Limits apply for  $T_A = 25^\circ C$ .

Symbol	Parameter	Conditions	LM4844		Units (Limits)
			Typical (Note 6)	Limits (Notes 7, 8)	
$I_{DD}$	Supply Current	$V_{IN} = 0V$ , No load; LD5 = RD5 = 0			
		Mode 4, 9, 14	4.5	7.5	mA (max)
		Mode 2, 7, 12	10	16	mA (max)
		Mode 3, 8, 13	11	18	mA (max)
$I_{SD}$	Shutdown Current	Mode 0	0.1	2	$\mu A$ (max)
$P_O$	Output Power	Speaker; THD+N = 1%; $f = 1kHz$ ; 4 $\Omega$ BTL	390	320	mW (min)
		Headphone; THD+N = 1%; $f = 1kHz$ ; 32 $\Omega$ SE	28	21	mW (min)
THD+N	Total Harmonic Distortion Plus Noise	LD5 = RD5 = 0			
		Speaker; $P_O = 200mW$ ; $f = 1kHz$ ; 8 $\Omega$ BTL	0.05		%
		Headphone; $P_O = 10mW$ ; $f = 1kHz$ ; 32 $\Omega$ SE	0.05		%
$V_{OS}$	Offset Voltage	Speaker; LD5 = RD5 = 0	5	40	mV (max)
		Headphone; LD5 = RD5 = 0	2	30	mV (max)
$N_{OUT}$	Output Noise	A-weighted; 0dB gain; LD5 = RD5 = 0			
		Speaker; Mode 2, 3, 7, 8	32		$\mu V$
		Speaker; Mode 12, 13	41		$\mu V$
		Headphone; Mode 3, 4, 8, 9	13		$\mu V$
		Headphone; Mode 13, 14	15		$\mu V$
PSRR	Power Supply Rejection Ratio	$f = 217Hz$ , $V_{rip} = 200mV_{pp}$ ; $C_B = 2.2\mu F$ ; 0dB Gain Setting; LD5 = RD5 = 0			
		Speaker; Mode 2, 3, 7, 8	73		dB
		Speaker; Mode 12, 13,	66	55	dB (min)
		Headphone; Mode 3, 4, 8, 9	78		dB
		Headphone; Mode 13, 14	72	62	dB (min)
Xtalk	Crosstalk	LD5 = RD5 = 0			
		Loudspeaker; $P_O = 200mW$ ; $f = 1kHz$	85		dB
		Headphone; $P_O = 10mW$ ; $f = 1kHz$	60		dB
$T_{WU}$	Wake-up Time	CD4 = 0; $C_B = 2.2\mu F$	70		ms
		CD4 = 1; $C_B = 2.2\mu F$	30		ms

## Volume Control Electrical Characteristics (Notes 1, 2)

The following specifications apply for  $3V \leq V_{DD} \leq 5V$  and  $3V \leq I^2CV_{DD} \leq 5V$ , unless otherwise specified. Limits apply for  $T_A = 25^\circ C$ .

www.DataSheet4U.com

Symbol	Parameter	Conditions	LM4844		Units (Limits)
			Typical (Note 6)	Limits (Notes 7, 8)	
	Stereo Volume Control Range	maximum gain setting	6	5.5 6.5	dB (min) dB (max)
		minimum gain setting	-40.5	-41 -40	dB (min) dB (max)
	Mono Volume Control Range	maximum gain setting	12	11.5 12.5	dB (min) dB (max)
		minimum gain setting	-34.5	-35 -34	dB (min) dB (max)
	Volume Control Step Size		1.5		dB
	Volume Control Step Size Error		+/-0.2	+/-0.5	dB (max)
	Stereo Channel to Channel Gain Mismatch		0.3		dB
	Mute Attenuation	Mode 12, $V_{in} = 1V_{RMS}$			
		Headphone	100		dB
	$L_{IN}$ and $R_{IN}$ Input Impedance	maximum gain setting	33	25 42	k $\Omega$ (min) k $\Omega$ (max)
		minimum gain setting	100	75 125	k $\Omega$ (min) k $\Omega$ (max)
	$M_{IN}$ Input Impedance	maximum gain setting	20	15 25	k $\Omega$ (min) k $\Omega$ (max)
		minimum gain setting	96	73 123	k $\Omega$ (min) k $\Omega$ (max)

## Control Interface Electrical Characteristics (Notes 1, 2)

The following specifications apply for  $V_{DD} = 5.0V$  and  $3.0V$ ,  $T_A = 25^\circ C$ ,  $2.2V \leq I^2CV_{DD} \leq 5.5V$ , unless otherwise specified.

Symbol	Parameter	Conditions	LM4844		Units (Limits)
			Typical (Note 6)	Limits (Notes 1, 7, 8)	
$t_1$	I <sup>2</sup> C Clock Period			2.5	$\mu s$ (min)
$t_2$	I <sup>2</sup> C Data Setup Time			100	ns (min)
$t_3$	I <sup>2</sup> C Data Stable Time			0	ns (min)
$t_4$	Start Condition Time			100	ns (min)
$t_5$	Stop Condition time			100	ns (min)
$t_6$	I <sup>2</sup> C Data Hold Time			100	ns (min)
$V_{IH}$	I <sup>2</sup> C Input Voltage High			$0.7 \times I^2CV_{DD}$	V (min)
$V_{IL}$	I <sup>2</sup> C Input Voltage Low			$0.3 \times I^2CV_{DD}$	V (max)

## Control Interface Electrical Characteristics (Notes 1, 2)

The following specifications apply for  $V_{DD} = 5.0V$  and  $3.0V$ ,  $T_A = 25^\circ C$ ,  $1.7V \leq I^2CV_{DD} \leq 2.2V$ , unless otherwise specified.

Symbol	Parameter	Conditions	LM4844		Units (Limits)
			Typical (Note 6)	Limits (Notes 1, 7, 8)	
$t_1$	I <sup>2</sup> C Clock Period			2.5	$\mu s$ (min)
$t_2$	I <sup>2</sup> C Data Setup Time			250	ns (min)
$t_3$	I <sup>2</sup> C Data Stable Time			0	ns (min)

Symbol	Parameter	Conditions	LM4844		Units (Limits)
			Typical (Note 6)	Limits (Notes 1, 7, 8)	
$t_4$	Start Condition Time			250	ns (min)
$t_5$	Stop Condition time			250	ns (min)
$t_6$	I <sup>2</sup> C Data Hold Time			250	ns (min)
$V_{IH}$	I <sup>2</sup> C Input Voltage High			$0.7 \times I^2CV_{DD}$	V (min)
$V_{IL}$	I <sup>2</sup> C Input Voltage Low			$0.25 \times I^2CV_{DD}$	V (max)

**Note 1:** All voltages are measured with respect to the GND pin unless otherwise specified.

**Note 2:** Absolute Maximum Ratings indicate limits beyond which damage to the device may occur. Operating Ratings indicate conditions for which the device is functional but do not guarantee specific performance limits. Electrical Characteristics state DC and AC electrical specifications under particular test conditions which guarantee specific performance limits. This assumes that the device is within the Operating Ratings. Specifications are not guaranteed for parameters where no limit is given, however, the typical value is a good indication of device performance.

**Note 3:** The maximum power dissipation must be derated at elevated temperatures and is dictated by  $T_{JMAX}$ ,  $\theta_{JA}$ , and the ambient temperature,  $T_A$ . The maximum allowable power dissipation is  $P_{DMAX} = (T_{JMAX} - T_A) / \theta_{JA}$  or the number given in Absolute Maximum Ratings, whichever is lower. For the LM4844 typical application with  $V_{DD} = 3.3V$  and  $R_L = 8\Omega$  stereo operation, the total power dissipation is TBDW.  $\theta_{JA} = TBD^\circ C/W$ .

**Note 4:** Human body model, 100pF discharged through a 1.5k $\Omega$  resistor.

**Note 5:** Machine Model, 220pF-240pF discharged through all pins.

**Note 6:** Typicals are measured at +25°C and represent the parametric norm.

**Note 7:** Limits are guaranteed to National's AOQL (Average Outgoing Quality Level).

**Note 8:** Datasheet min/max specification limits are guaranteed by design, test, or statistical analysis.

**Note 9:** Shutdown current and supply current are measured in a normal room environment.

**Note 10:** Refer to Control Interface Electrical Characteristics tables on page 6.



# Typical Performance Characteristics

**LM4844TL THD+N vs Frequency**  
 $V_{DD} = 5V, R_L = 8\Omega, \text{Mode 7}$   
 $LS, P_O = 400mW$

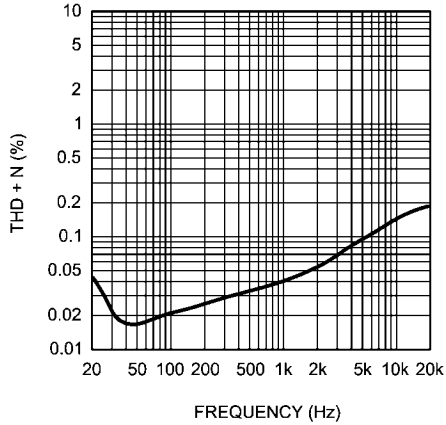

20153563

**LM4844TL THD+N vs Frequency**  
 $V_{DD} = 3V, R_L = 8\Omega, \text{Mode 7}$   
 $LS, P_O = 200mW$

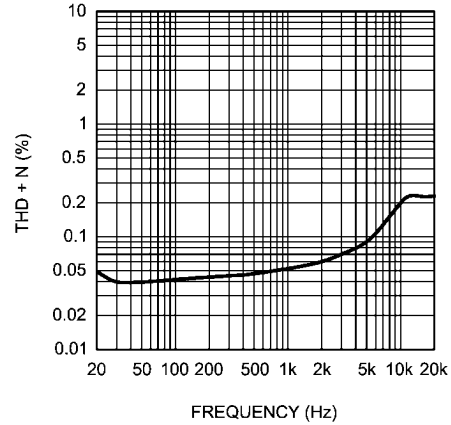

20153564

**LM4844TL THD+N vs Frequency**  
 $V_{DD} = 5V, R_L = 32\Omega, \text{Mode 9}$   
 $HP, P_O = 15mW, 0dB \text{ Gain}$

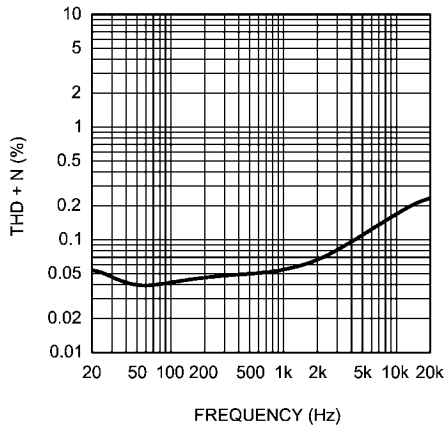

20153567

**LM4844TL THD+N vs Frequency**  
 $V_{DD} = 3V, R_L = 32\Omega, \text{Mode 9}$   
 $HP, P_O = 10mW, 0dB \text{ Gain}$

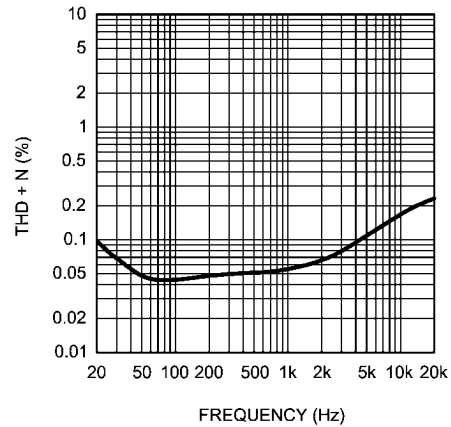

20153568

**LM4844TL THD+N vs Output Power**  
 $V_{DD} = 5V, R_L = 8\Omega, \text{Mode 7}$   
 $LS, f = 1kHz, 0dB \text{ Gain}$

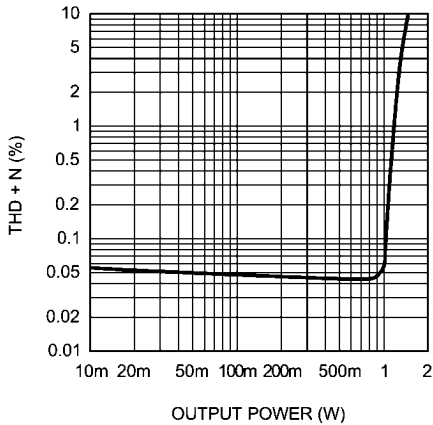

20153565

**LM4844TL THD+N vs Output Power**  
 $V_{DD} = 3V, R_L = 8\Omega, \text{Mode 7}$   
 $LS, f = 1kHz, 0dB \text{ Gain}$

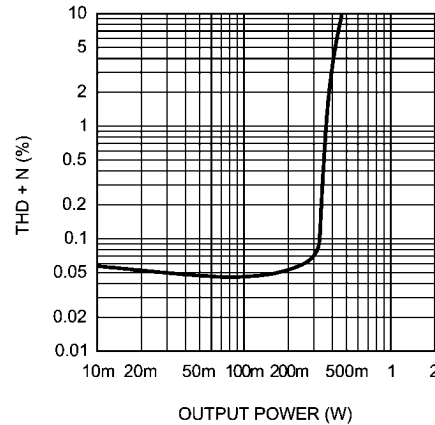

20153566

**LM4844TL THD+N vs Output Power**  
 $V_{DD} = 5V, R_L = 32\Omega, \text{ Mode 9}$   
 HP,  $f = 1\text{kHz}, 0\text{dB Gain}$

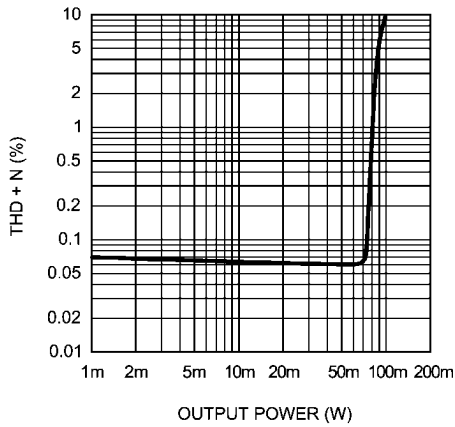

20153569

**LM4844TL THD+N vs Output Power**  
 $V_{DD} = 3V, R_L = 32\Omega, \text{ Mode 9}$   
 HP,  $f = 1\text{kHz}, 0\text{dB Gain}$

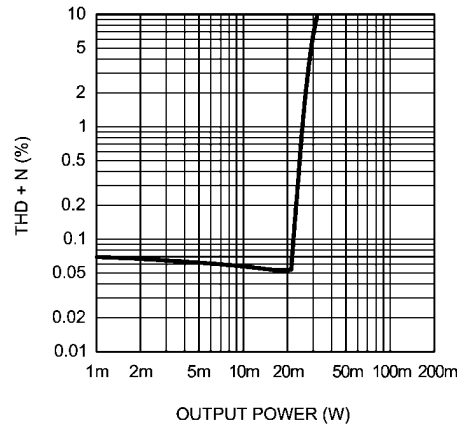

20153570

**LM4844TL PSRR vs Frequency**  
 $V_{DD} = 5V, R_L = 8\Omega, \text{ LS}$   
 Top-Modes 12, 13  
 Bottom-Modes 2, 3, 7, 8

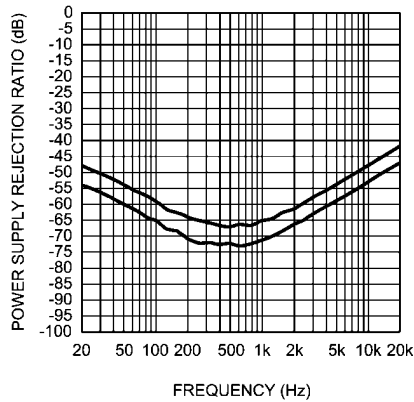

20153571

**LM4844TL PSRR vs Frequency**  
 $V_{DD} = 3V, R_L = 8\Omega, \text{ LS}$   
 Top-Modes 12, 13  
 Bottom-Modes 2, 3, 7, 8

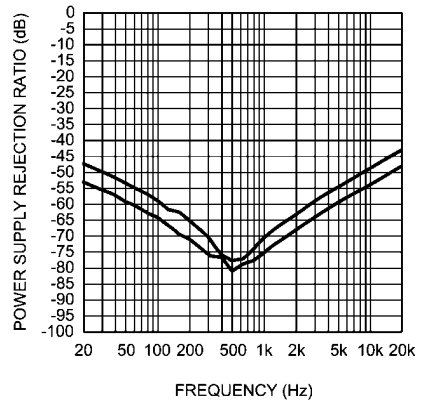

20153572

**LM4844TL PSRR vs Frequency**  
 $V_{DD} = 5V, R_L = 32\Omega, \text{ HP}$   
 Top-Modes 13, 14  
 Bottom-Modes 3, 4, 8, 9

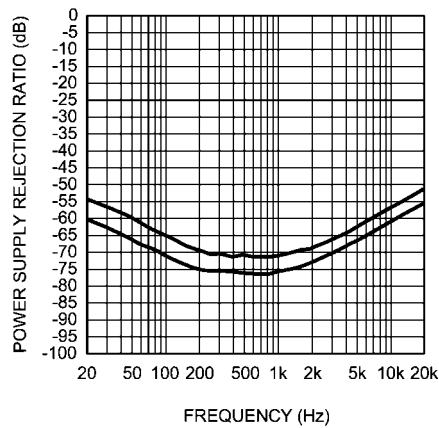

20153573

**LM4844TL PSRR vs Frequency**  
 $V_{DD} = 3V, R_L = 32\Omega, \text{ HP}$   
 Top-Modes 13, 14  
 Bottom-Modes 3, 4, 8, 9

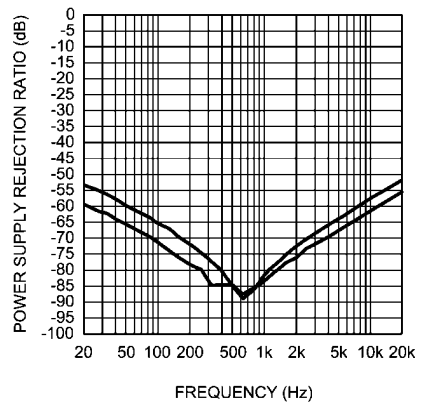

20153574

**LM4844TL Crosstalk vs Frequency**  
 $V_{DD} = 5V, R_L = 8\Omega, \text{Mode 7}$   
 $LS, P_O = 400mW$

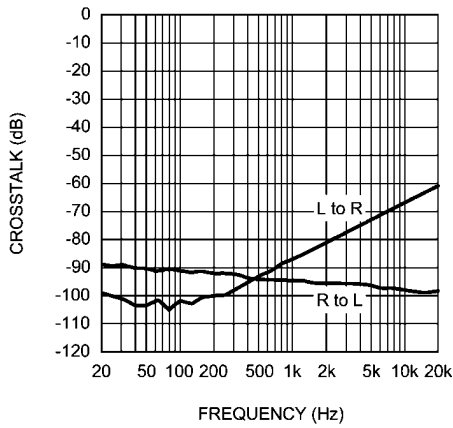

20153575

**LM4844TL Crosstalk vs Frequency**  
 $V_{DD} = 3V, R_L = 8\Omega, \text{Mode 7}$   
 $LS, P_O = 200mW$

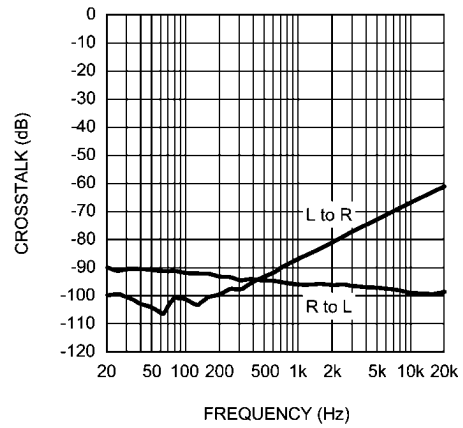

20153576

**LM4844TL Crosstalk vs Frequency**  
 $V_{DD} = 5V, R_L = 32\Omega, \text{Mode 9}$   
 $HP, P_O = 15mW, 0dB \text{ Gain}$

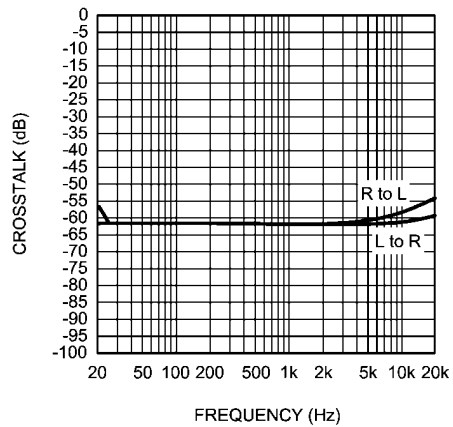

20153577

**LM4844TL Crosstalk vs Frequency**  
 $V_{DD} = 3V, R_L = 32\Omega, \text{Mode 9}$   
 $HP, P_O = 10mW, 0dB \text{ Gain}$

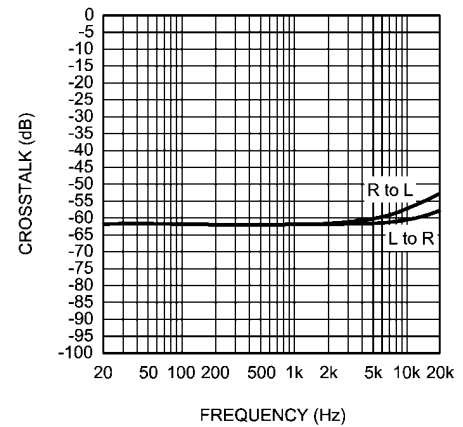

20153578

**LM4844TL Frequency Response**  
 $V_{DD} = 5V, R_L = 8\Omega, \text{Mode 2}$   
 $LS, \text{Full Gain} = 18dB$

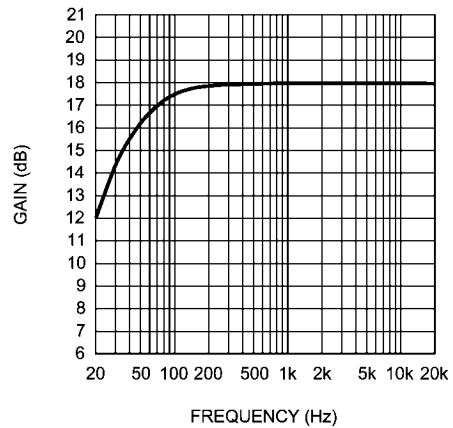

20153579

**LM4844TL Frequency Response**  
 $V_{DD} = 5V, R_L = 8\Omega, \text{Mode 7}$   
 $LS, \text{Full Gain} = 12dB$

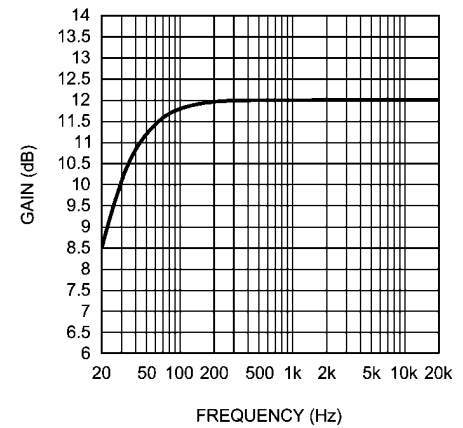

20153580

**LM4844TL Frequency Response**  
 $V_{DD} = 5V, R_L = 32\Omega$ , Mode 4  
 HP, Full Gain = 12dB

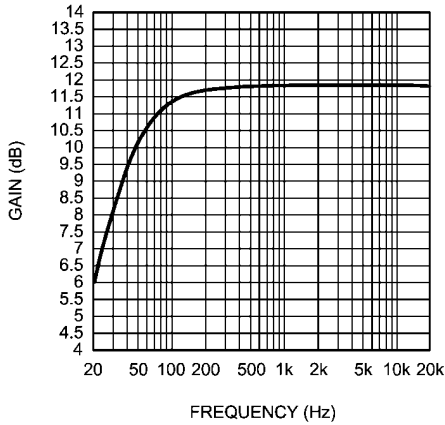

20153581

**LM4844TL Frequency Response**  
 $V_{DD} = 5V, R_L = 32\Omega$ , Mode 9  
 HP, Full Gain = 6dB

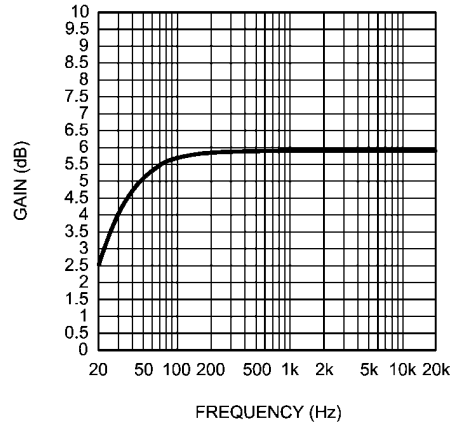

20153582

**LM4844TL Power Dissipation vs Output Power**  
 $V_{DD} = 5V, R_L = 8\Omega$   
 LS, per channel

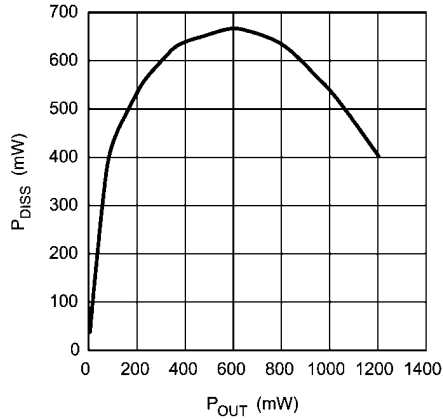

20153583

**LM4844TL Power Dissipation vs Output Power**  
 $V_{DD} = 3V, R_L = 8\Omega$   
 LS, per channel

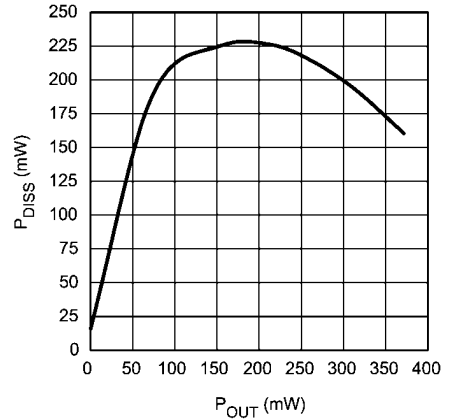

20153584

**LM4844TL Power Dissipation vs Output Power**  
 $V_{DD} = 5V, R_L = 8\Omega$   
 OCL HP, per channel

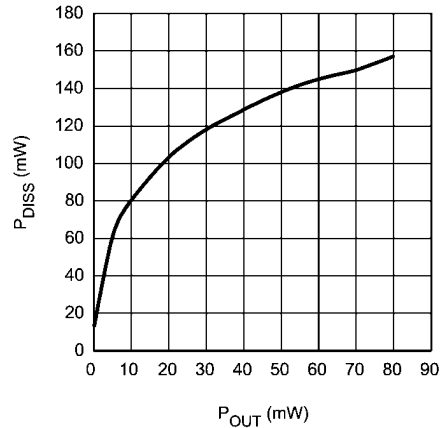

20153585

**LM4844TL Power Dissipation vs Output Power**  
 $V_{DD} = 3V, R_L = 32\Omega$   
 OCL HP, per channel

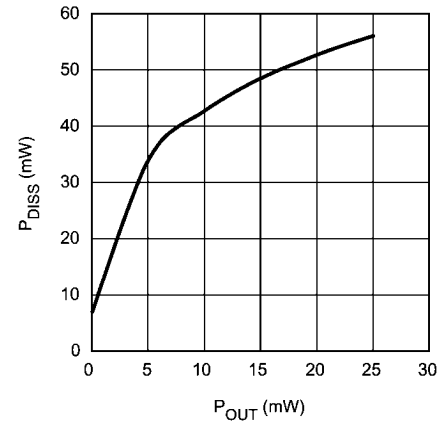

20153586

**LM4844TL Output Power vs Load Resistance, LS**  
 Top- $V_{DD} = 5V, 10\% THD+N$ ; Topmid- $V_{DD} = 5V, 1\% THD+N$   
 Botmid- $V_{DD} = 3V, 10\% THD+N$ ;  
 Bot- $V_{DD} = 3V, 1\% THD+N$

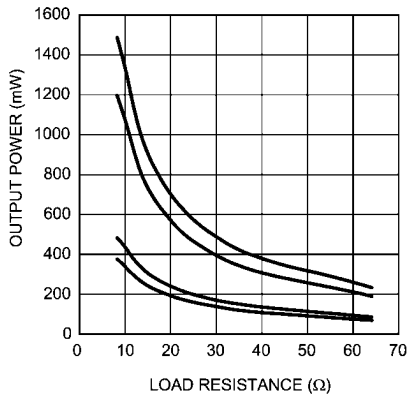

20153587

**LM4844TL Output Power vs Load Resistance, HP**  
 Top- $V_{DD} = 5V, 10\% THD+N$ ; Topmid- $V_{DD} = 5V, 1\% THD+N$   
 Botmid- $V_{DD} = 3V, 10\% THD+N$ ;  
 Bot- $V_{DD} = 3V, 1\% THD+N$

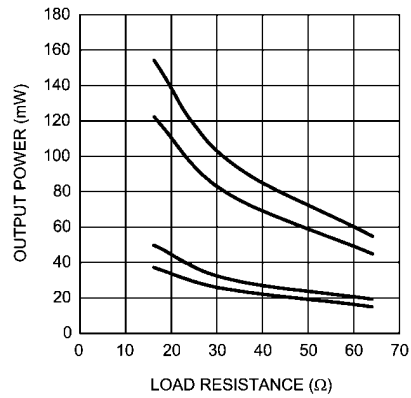

20153588

**LM4844TL Output Power vs Supply Voltage, LS**  
 $R_L = 8\Omega$ ; Top- 10%THD+N , Bot- 1%THD+N

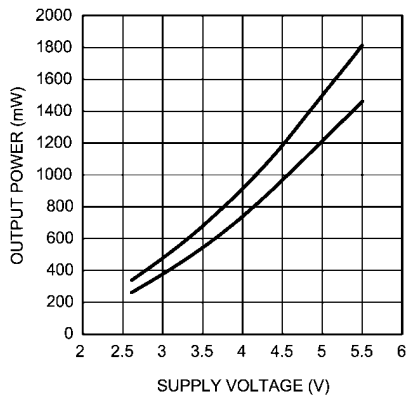

20153589

**LM4844TL Output Power vs Supply Voltage, HP**  
 $R_L = 32\Omega$ ; Top- 10%THD+N, Bot- 1%THD+N

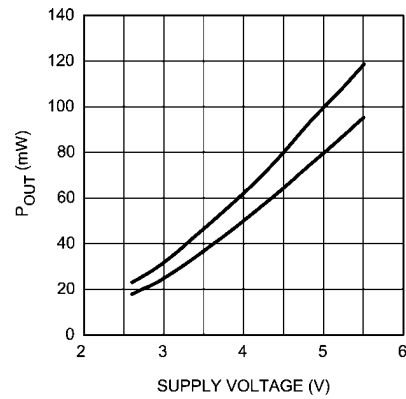

20153590

## Application Information

www.DataSheet4U.com

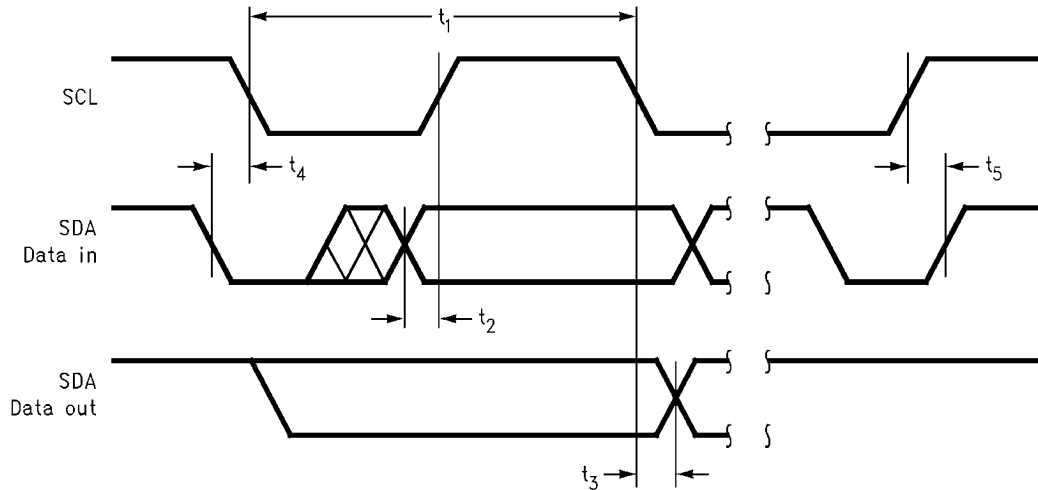

20153524

FIGURE 2. I²C Timing Diagram

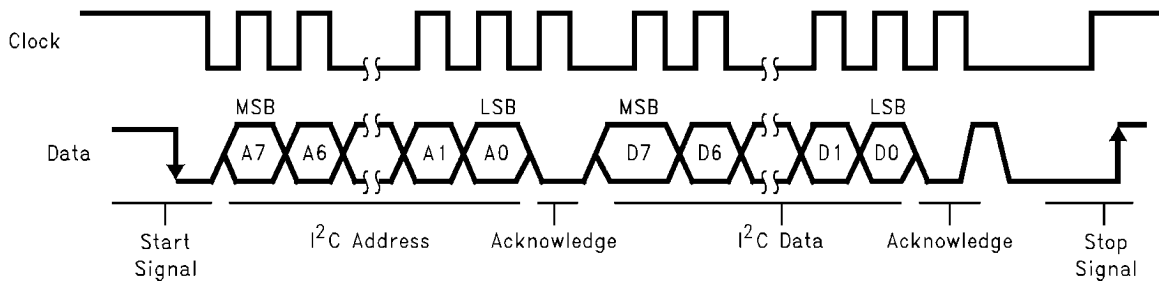

20153525

FIGURE 3. I²C Bus Format

TABLE 1. Chip Address

	A7	A6	A5	A4	A3	A2	A1	A0
Chip Address	1	1	1	1	1	0	EC	0
ADR = 0	1	1	1	1	1	0	0	0
ADR = 1	1	1	1	1	1	0	1	0

EC - externally configured by ADR pin

TABLE 2. Control Registers

	D7	D6	D5	D4	D3	D2	D1	D0
Mono Volume control	0	0	0	MD4	MD3	MD2	MD1	MD0
Left Volume control	0	1	LD5	LD4	LD3	LD2	LD1	LD0
Right Volume control	1	0	RD5	RD4	RD3	RD2	RD1	RD0
Mode control	1	1	CD5	0	CD3	CD2	CD1	CD0

TABLE 3. Mono Volume Control

www.DataSheet4U.com

MD4	MD3	MD2	MD1	MD0	Gain (dB)
0	0	0	0	0	-34.5
0	0	0	0	1	-33.0
0	0	0	1	0	-31.5
0	0	0	1	1	-30.0
0	0	1	0	0	-28.5
0	0	1	0	1	-27.0
0	0	1	1	0	-25.5
0	0	1	1	1	-24.0
0	1	0	0	0	-22.5
0	1	0	0	1	-21.0
0	1	0	1	0	-19.5
0	1	0	1	1	-18.0
0	1	1	0	0	-16.5
0	1	1	0	1	-15.0
0	1	1	1	0	-13.5
0	1	1	1	1	-12.0
1	0	0	0	0	-10.5
1	0	0	0	1	-9.0
1	0	0	1	0	-7.5
1	0	0	1	1	-6.0
1	0	1	0	0	-4.5
1	0	1	0	1	-3.0
1	0	1	1	0	-1.5
1	0	1	1	1	0.0
1	1	0	0	0	1.5
1	1	0	0	1	3.0
1	1	0	1	0	4.5
1	1	0	1	1	6.0
1	1	1	0	0	7.5
1	1	1	0	1	9.0
1	1	1	1	0	10.5
1	1	1	1	1	12.0

TABLE 4. Stereo Volume Control

www.DataSheet4U.com

LD4//RD4	LD3//RD3	LD2//RD2	LD1//RD1	LD0//RD0	Gain (dB)
0	0	0	0	0	-40.5
0	0	0	0	1	-39.0
0	0	0	1	0	-37.5
0	0	0	1	1	-36.0
0	0	1	0	0	-34.5
0	0	1	0	1	-33.0
0	0	1	1	0	-31.5
0	0	1	1	1	-30.0
0	1	0	0	0	-28.5
0	1	0	0	1	-27.0
0	1	0	1	0	-25.5
0	1	0	1	1	-24.0
0	1	1	0	0	-22.5
0	1	1	0	1	-21.0
0	1	1	1	0	-19.5
0	1	1	1	1	-18.0
1	0	0	0	0	-16.5
1	0	0	0	1	-15.0
1	0	0	1	0	-13.5
1	0	0	1	1	-12.0
1	0	1	0	0	-10.5
1	0	1	0	1	-9.0
1	0	1	1	0	-7.5
1	0	1	1	1	-6.0
1	1	0	0	0	-4.5
1	1	0	0	1	-3.0
1	1	0	1	0	-1.5
1	1	0	1	1	0.0
1	1	1	0	0	1.5
1	1	1	0	1	3.0
1	1	1	1	0	4.5
1	1	1	1	1	6.0



TABLE 5. Mixer and Output Mode

www.DataSheet4U.com

Mode	CD3	CD2	CD1	CD0	Loudspeaker L	Loudspeaker R	Headphone L	Headphone R
0	0	0	0	0	SD	SD	SD	SD
1	0	0	0	1	RESERVED			
2	0	0	1	0	$2(G_M \times M)$	$2(G_M \times M)$	MUTE	MUTE
3	0	0	1	1	$2(G_M \times M)$	$2(G_M \times M)$	$(G_M \times M)$	$(G_M \times M)$
4	0	1	0	0	SD	SD	$(G_M \times M)$	$(G_M \times M)$
5	0	1	0	1	RESERVED			
6	0	1	1	0	RESERVED			
7	0	1	1	1	$2(G_L \times L)$	$2(G_R \times R)$	MUTE	MUTE
8	1	0	0	0	$2(G_L \times L)$	$2(G_R \times R)$	$(G_L \times L)$	$(G_R \times R)$
9	1	0	0	1	SD	SD	$(G_L \times L)$	$(G_R \times R)$
10	1	0	1	0	RESERVED			
11	1	0	1	1	RESERVED			
12	1	1	0	0	$2(G_L \times L) + 2(G_M \times M)$	$2(G_R \times R) + 2(G_M \times M)$	MUTE	MUTE
13	1	1	0	1	$2(G_L \times L) + 2(G_M \times M)$	$2(G_R \times R) + 2(G_M \times M)$	$(G_L \times L) + (G_M \times M)$	$(G_R \times R) + (G_M \times M)$
14	1	1	1	0	SD	SD	$(G_L \times L) + (G_M \times M)$	$(G_R \times R) + (G_M \times M)$
15	1	1	1	1	RESERVED			

M -  $M_{IN}$  Input Level $G_L$  - Left Stereo Volume Control GainL -  $L_{IN}$  Input Level $G_R$  - Right Stereo Volume Control GainR -  $R_{IN}$  Input Level

SD - Shutdown

 $G_M$  - Mono Volume Control Gain

MUTE - Mute

TABLE 6. National 3D Enhancement

LD5	0	Loudspeaker National 3D Off
	1	Loudspeaker National 3D On
RD5	0	Headphone National 3D Off
	1	Headphone National 3D On

TABLE 7. Wake-up Time Select

CD5	0	Fast Wake-up Setting
	1	Slow Wake-up Setting

## I<sup>2</sup>C COMPATIBLE INTERFACE

The LM4844 uses a serial bus, which conforms to the I<sup>2</sup>C protocol, to control the chip's functions with two wires: clock (SCL) and data (SDA). The clock line is uni-directional. The data line is bi-directional (open-collector). The maximum clock frequency specified by the I<sup>2</sup>C standard is 400kHz. In this discussion, the master is the controlling microcontroller and the slave is the LM4844.

The I<sup>2</sup>C address for the LM4844 is determined using the ADR pin. The LM4844's two possible I<sup>2</sup>C chip addresses are of the form 111110X<sub>1</sub>0 (binary), where X<sub>1</sub> = 0, if ADR is logic low; and X<sub>1</sub> = 1, if ADR is logic high. If the I<sup>2</sup>C interface is used to address a number of chips in a system, the LM4844's chip address can be changed to avoid any possible address conflicts.

The bus format for the I<sup>2</sup>C interface is shown in Figure 2. The bus format diagram is broken up into six major sections:

The "start" signal is generated by lowering the data signal while the clock signal is high. The start signal will alert all devices attached to the I<sup>2</sup>C bus to check the incoming address against their own address.

The 8-bit chip address is sent next, most significant bit first. The data is latched in on the rising edge of the clock. Each address bit must be stable while the clock level is high.

After the last bit of the address bit is sent, the master releases the data line high (through a pull-up resistor). Then the master sends an acknowledge clock pulse. If the LM4844 has received the address correctly, then it holds the data line low during the clock pulse. If the data line is not held low during the acknowledge clock pulse, then the master should abort the rest of the data transfer to the LM4844.

The 8 bits of data are sent next, most significant bit first. Each data bit should be valid while the clock level is stable high.

After the data byte is sent, the master must check for another acknowledge to see if the LM4844 received the data.

If the master has more data bytes to send to the LM4844, then the master can repeat the previous two steps until all data bytes have been sent.

The "stop" signal ends the transfer. To signal "stop", the data signal goes high while the clock signal is high. The data line should be held high when not in use.

## I<sup>2</sup>C INTERFACE POWER SUPPLY PIN (I<sup>2</sup>CV<sub>DD</sub>)

The LM4844's I<sup>2</sup>C interface is powered up through the I<sup>2</sup>CV<sub>DD</sub> pin. The LM4844's I<sup>2</sup>C interface operates at a voltage level set by the I<sup>2</sup>CV<sub>DD</sub> pin which can be set independent to that of the main power supply pin V<sub>DD</sub>. This is ideal whenever logic levels for the I<sup>2</sup>C interface are dictated by a microcontroller or microprocessor that is operating at a lower supply voltage than the main battery of a portable system.

## NATIONAL 3D ENHANCEMENT

The LM4844 features a 3D audio enhancement effect that widens the perceived soundstage from a stereo audio signal. The 3D audio enhancement improves the apparent stereo channel separation whenever the left and right speakers are too close to one another, due to system size constraints or equipment limitations.

An external RC network, shown in Figure 1, is required to enable the 3D effect. There are separate RC networks for both the stereo loudspeaker outputs as well as the stereo headphone outputs, so the 3D effect can be set independently for each set of stereo outputs.

The amount of the 3D effect is set by the R<sub>3D</sub> resistor. Decreasing the value of R<sub>3D</sub> will increase the 3D effect. The

C<sub>3D</sub> capacitor sets the low cutoff frequency of the 3D effect. Increasing the value of C<sub>3D</sub> will decrease the low cutoff frequency at which the 3D effect starts to occur, as shown by Equation 1.

$$f_{3D(-3dB)} = 1 / 2\pi(R_{3D})(C_{3D}) \quad (1)$$

Activating the 3D effect will cause an increase in gain by a multiplication factor of (1 + 20kΩ/R<sub>3D</sub>). Setting R<sub>3D</sub> to 20kΩ will result in a gain increase by a multiplication factor of (1 + 20kΩ/20kΩ) = 2 or 6dB whenever the 3D effect is activated. The volume control can be programmed through the I<sup>2</sup>C compatible interface to compensate for the extra 6dB increase in gain. For example, if the stereo volume control is set at 0dB (11011 from Table 4) before the 3D effect is activated, the volume control should be programmed to -6dB (10111 from Table 4) immediately after the 3D effect has been activated. Setting R<sub>3D</sub> = 20kΩ and C<sub>3D</sub> = 0.22μF allows the LM4844 to produce a pronounced 3D effect with a minimal increase in output noise.

## OUTPUT CAPACITOR-LESS (OCL) OPERATION AND LAYOUT TECHNIQUES FOR OPTIMUM CROSSTALK

The LM4844's OCL headphone architecture eliminates output coupling capacitors. Unless the headphone is in shutdown, the OCL output will be at a bias voltage of ½V<sub>DD</sub>, which is applied to the stereo headphone jack's sleeve. This voltage matches the bias voltage present on LHP and RHP outputs that drive the headphones. The headphones operate in a manner similar to a bridge-tied load (BTL). Because the same DC voltage is applied to both headphone speaker terminals there is no net DC current flow through the speaker. AC current flows through a headphone speaker as an audio signal's output amplitude increases on the speaker's terminal.

The headphone jack's sleeve is not connected to circuit ground when used in OCL mode. Using the headphone output jack as a line-level output will place the LM4844's ½V<sub>DD</sub> bias voltage on a plug's sleeve connection.

Since the LHP and RHP outputs of the LM4844 share the OCL output as a reference, certain layout techniques should be used in order to achieve optimum crosstalk performance. The crosstalk will depend on the parasitic resistance of the trace connecting the LM4844 OCL output to the headphone jack sleeve and on the load resistance value. Since the load resistance is often predetermined, it is advisable to use a trace that is as short and as wide as possible. Reasonable application of this layout technique will result in crosstalk values of 60dB, as specified in the electrical characteristics table.

## BRIDGE CONFIGURATION EXPLANATION

The LM4844 consists of two sets of bridged-tied amplifier pairs that drive the left loudspeaker (LLS) and the right loudspeaker (RLS). For this discussion, only the LLS bridge-tied amplifier pair will be referred to. The LM4844 drives a load, such as a speaker, connected between outputs, LLS+ and LLS-. In the LLS amplifier block, the output of the amplifier that drives LLS- serves as the input to the unity gain inverting amplifier that drives LLS+.

This results in both amplifiers producing signals identical in magnitude, but 180° out of phase. Taking advantage of this phase difference, a load is placed between LLS- and LLS+ and driven differentially (commonly referred to as 'bridge mode'). This results in a differential or BTL gain of:

$$A_{VD} = 2(R_f / R_i) = 2 \quad (2)$$

Both the feedback resistor,  $R_f$ , and the input resistor,  $R_i$ , are internally set.

Bridge mode amplifiers are different from single-ended amplifiers that drive loads connected between a single amplifier's output and ground. For a given supply voltage, bridge mode has a distinct advantage over the single-ended configuration: its differential output doubles the voltage swing across the load. Theoretically, this produces four times the output power when compared to a single-ended amplifier under the same conditions. This increase in attainable output power assumes that the amplifier is not current limited and that the output signal is not clipped.

Another advantage of the differential bridge output is no net DC voltage across the load. This is accomplished by biasing LLS- and LLS+ outputs at half-supply. This eliminates the coupling capacitor that single supply, single-ended amplifiers require. Eliminating an output coupling capacitor in a typical single-ended configuration forces a single-supply amplifier's half-supply bias voltage across the load. This increases internal IC power dissipation and may permanently damage loads such as speakers.

### POWER DISSIPATION

Power dissipation is a major concern when designing a successful single-ended or bridged amplifier.

A direct consequence of the increased power delivered to the load by a bridge amplifier is higher internal power dissipation. The LM4844 has 2 sets of bridged-tied amplifier pairs driving LLS and RLS. The maximum internal power dissipation operating in the bridge mode is twice that of a single-ended amplifier. From Equation (3) and (4), assuming a 5V power supply and an  $8\Omega$  load, the maximum power dissipation for LLS and RLS is 634mW per channel.

$$P_{\text{DMAX-LLS}} = 4(V_{\text{DD}})^2 / (2\pi^2 R_L): \text{ Bridged} \quad (3)$$

$$P_{\text{DMAX-RLS}} = 4(V_{\text{DD}})^2 / (2\pi^2 R_L): \text{ Bridged} \quad (4)$$

The LM4844 also has a pair of single-ended amplifiers driving LHP and RHP. The maximum internal power dissipation for ROUT and LOU is given by equation (5) and (6). From Equations (5) and (6), assuming a 5V power supply and a  $32\Omega$  load, the maximum power dissipation for LOU and ROUT is 40mW per channel.

$$P_{\text{DMAX-LHP}} = (V_{\text{DD}})^2 / (2\pi^2 R_L): \text{ Single-ended} \quad (5)$$

$$P_{\text{DMAX-RHP}} = (V_{\text{DD}})^2 / (2\pi^2 R_L): \text{ Single-ended} \quad (6)$$

The maximum internal power dissipation of the LM4844 occurs during output modes 3, 8, and 13 when both loudspeaker and headphone amplifiers are simultaneously on; and is given by Equation (7).

$$P_{\text{DMAX-TOTAL}} = P_{\text{DMAX-LLS}} + P_{\text{DMAX-RLS}} + P_{\text{DMAX-LHP}} + P_{\text{DMAX-RHP}} \quad (7)$$

The maximum power dissipation point given by Equation (7) must not exceed the power dissipation given by Equation (8):

$$P_{\text{DMAX}'} = (T_{\text{JMAX}} - T_A) / \theta_{\text{JA}} \quad (8)$$

The LM4844's  $T_{\text{JMAX}} = 150^\circ\text{C}$ . In the TL package, the LM4844's  $\theta_{\text{JA}}$  is  $62^\circ\text{C/W}$ . At any given ambient temperature  $T_A$ , use Equation (8) to find the maximum internal power dissipation supported by the IC packaging. Rearranging Equation (8) and substituting  $P_{\text{DMAX-TOTAL}}$  for  $P_{\text{DMAX}'}$  results in Equation (9). This equation gives the maximum ambient temperature that still allows maximum stereo power dissipation without violating the LM4844's maximum junction temperature.

$$T_A = T_{\text{JMAX}} - P_{\text{DMAX-TOTAL}} \theta_{\text{JA}} \quad (9)$$

For a typical application with a 5V power supply, stereo  $8\Omega$  loudspeaker load, and the stereo  $32\Omega$  headphone load, the maximum ambient temperature that allows maximum stereo power dissipation without exceeding the maximum junction temperature is approximately  $100^\circ\text{C}$  for the TL package.

$$T_{\text{JMAX}} = P_{\text{DMAX-TOTAL}} \theta_{\text{JA}} + T_A \quad (10)$$

Equation (10) gives the maximum junction temperature  $T_{\text{JMAX}}$ . If the result violates the LM4844's  $150^\circ\text{C}$ , reduce the maximum junction temperature by reducing the power supply voltage or increasing the load resistance. Further allowance should be made for increased ambient temperatures.

The above examples assume that a device is a surface mount part operating around the maximum power dissipation point. Since internal power dissipation is a function of output power, higher ambient temperatures are allowed as output power or duty cycle decreases. If the result of Equation (7) is greater than that of Equation (8), then decrease the supply voltage, increase the load impedance, or reduce the ambient temperature. If these measures are insufficient, a heat sink can be added to reduce  $\theta_{\text{JA}}$ . The heat sink can be created using additional copper area around the package, with connections to the ground pin(s), supply pin and amplifier output pins. External, solder attached SMT heatsinks such as the Thermalloy 7106D can also improve power dissipation. When adding a heat sink, the  $\theta_{\text{JA}}$  is the sum of  $\theta_{\text{JC}}$ ,  $\theta_{\text{CS}}$ , and  $\theta_{\text{SA}}$ . ( $\theta_{\text{JC}}$  is the junction-to-case thermal impedance,  $\theta_{\text{CS}}$  is the case-to-sink thermal impedance, and  $\theta_{\text{SA}}$  is the sink-to-ambient thermal impedance.) Refer to the Typical Performance Characteristics curves for power dissipation information at lower output power levels.

## POWER SUPPLY BYPASSING

As with any power amplifier, proper supply bypassing is critical for low noise performance and high power supply rejection. Applications that employ a 5V regulator typically use a 10 $\mu$ F in parallel with a 0.1 $\mu$ F filter capacitors to stabilize the regulator's output, reduce noise on the supply line, and improve the supply's transient response. However, their presence does not eliminate the need for a local 1.0 $\mu$ F tantalum bypass capacitance connected between the LM4844's supply pins and ground. Keep the length of leads and traces that connect capacitors between the LM4844's power supply pin and ground as short as possible.

## SELECTING EXTERNAL COMPONENTS

### Input Capacitor Value Selection

Amplifying the lowest audio frequencies requires a high value input coupling capacitor ( $C_i$  in Figure 1). In many cases, however, the speakers used in portable systems, whether internal or external, have little ability to reproduce signals below 50Hz. Applications using speakers with this limited frequency response reap little improvement; by using a large input capacitor.

The internal input resistor ( $R_i$ ) and the input capacitor ( $C_i$ ) produce a high pass filter cutoff frequency that is found using Equation (13).

$$f_c = 1 / (2\pi R_i C_i) \quad (11)$$

As an example when using a speaker with a low frequency limit of 50Hz and  $R_i = 20k\Omega$ ,  $C_i$ , using Equation (13) is 0.19 $\mu$ F. The 0.22 $\mu$ F  $C_i$  shown in Figure 4 allows the LM4844 to drive high efficiency, full range speaker whose response extends below 40Hz.

### Bypass Capacitor Value Selection

Besides minimizing the input capacitor size, careful consideration should be paid to value of  $C_B$ , the capacitor connected to the BYPASS pin. Since  $C_B$  determines how fast the LM4844 settles to quiescent operation, its value is critical when minimizing turn-on pops. The slower the LM4844's outputs ramp to their quiescent DC voltage (nominally  $V_{DD}/2$ ), the smaller the turn-on pop. Choosing  $C_B$  equal to 2.2 $\mu$ F along with a small value of  $C_i$  (in the range of 0.1 $\mu$ F to 0.39 $\mu$ F), produces a click-less and pop-less shutdown function. As discussed above, choosing  $C_i$  no larger than necessary for the desired bandwidth helps minimize clicks and pops.  $C_B$ 's value should be in the range of 5 times to 10 times the value of  $C_i$ . This ensures that output transients are eliminated when the LM4844 transitions in and out of shutdown mode. Connecting a 2.2 $\mu$ F capacitor,  $C_B$ , between the BYPASS pin and ground improves the internal bias voltage's stability and improves the amplifier's PSRR. The PSRR improvements increase as the bypass pin capacitor value increases. However, increasing the value of  $C_B$  will increase wake-up time. The selection of bypass capacitor value,  $C_B$ , depends on desired PSRR requirements, click and pop performance, wake-up time, system cost, and size constraints.

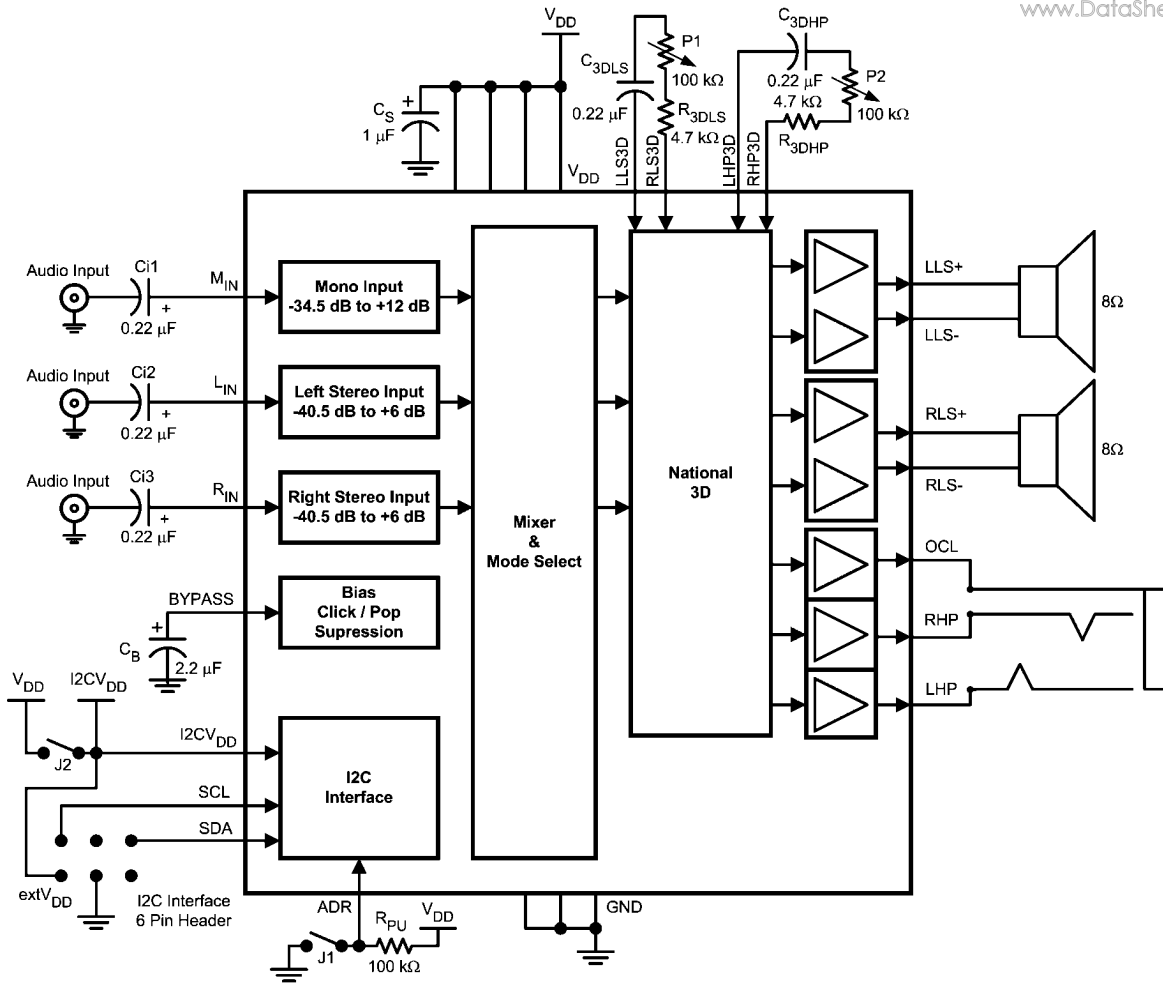

20153532

FIGURE 4. Reference Design Board Schematic

# Demonstration Board Layout

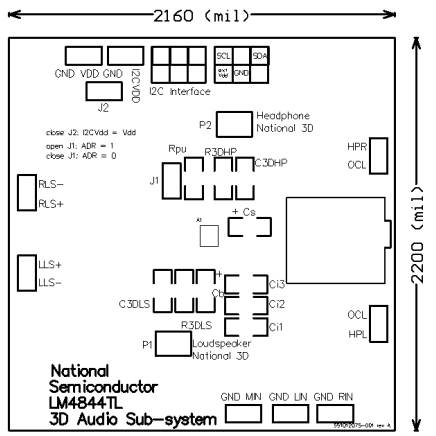

**Recommended TL PCB Layout: Silkscreen Layer**

20153517

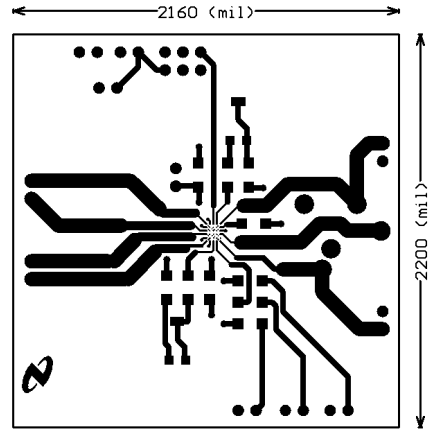

**Recommended TL PCB Layout: Top Layer**

20153518

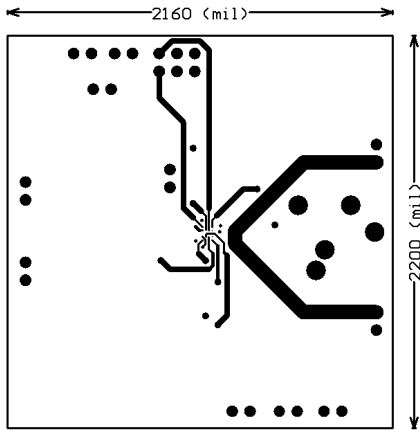

**Recommended TL PCB Layout: Mid Layer 1**

20153515

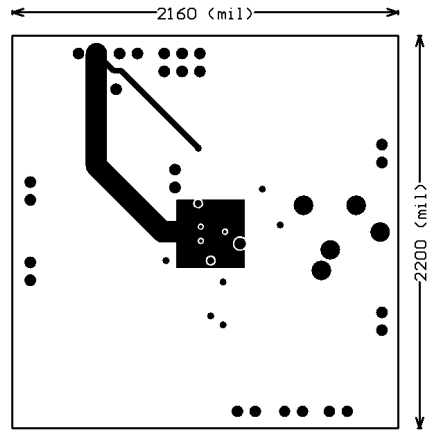

**Recommended TL PCB Layout: Mid Layer 2**

20153516

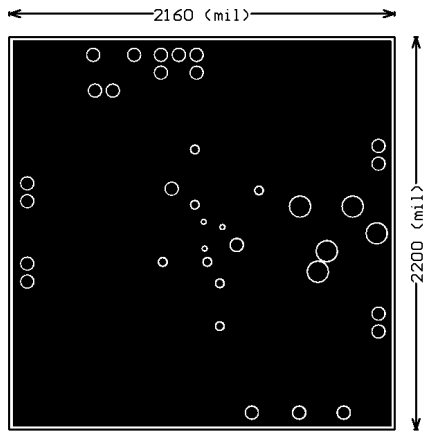

**Recommended TL PCB Layout: Bottom Layer**

20153514

## Revision History

[www.DataSheet4U.com](http://www.DataSheet4U.com)

Rev	Date	Description
1.1	06/01/06	Initial WEB.
1.2	07/20/07	Edited the Control Interface Electrical Characteristics tables.
1.3	08/07/07	Changed the I <sup>2</sup> C V <sub>DD</sub> from 1.8V into 1.7V (under the Operating Ratings).
1.4	08/23/07	Fixed one place of typo.

**Physical Dimensions** inches (millimeters) unless otherwise noted

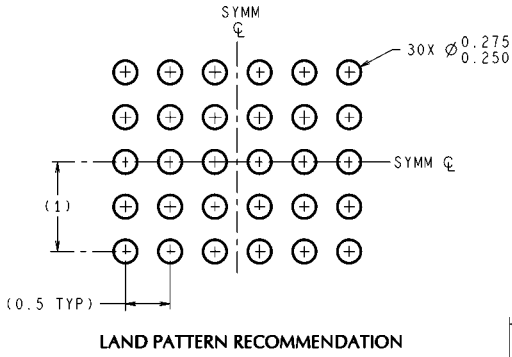

**DIMENSIONS ARE IN MILLIMETERS**  
DIMENSIONS IN ( ) FOR REFERENCE ONLY

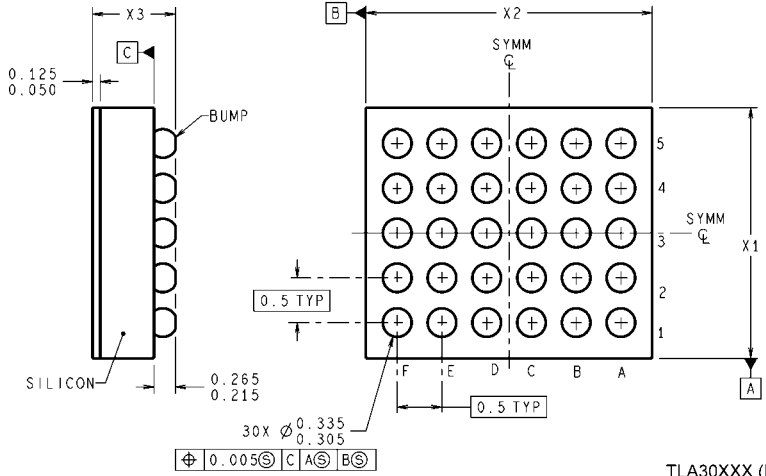
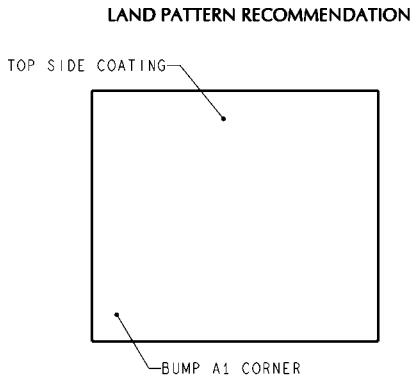

TLA30XXX (Rev C)

**30 Bump Micro SMD (TL) Package**  
**Order Number LM4844TL**  
**NS Package Number TLA30CZA**  
**X1 = 2.543±0.03 X2 = 2.949±0.03 X3 = 0.6±0.075**



# Notes

[www.DataSheet4U.com](http://www.DataSheet4U.com)

LM4844

## Notes

www.DataSheet4U.com

THE CONTENTS OF THIS DOCUMENT ARE PROVIDED IN CONNECTION WITH NATIONAL SEMICONDUCTOR CORPORATION ("NATIONAL") PRODUCTS. NATIONAL MAKES NO REPRESENTATIONS OR WARRANTIES WITH RESPECT TO THE ACCURACY OR COMPLETENESS OF THE CONTENTS OF THIS PUBLICATION AND RESERVES THE RIGHT TO MAKE CHANGES TO SPECIFICATIONS AND PRODUCT DESCRIPTIONS AT ANY TIME WITHOUT NOTICE. NO LICENSE, WHETHER EXPRESS, IMPLIED, ARISING BY ESTOPPEL OR OTHERWISE, TO ANY INTELLECTUAL PROPERTY RIGHTS IS GRANTED BY THIS DOCUMENT.

TESTING AND OTHER QUALITY CONTROLS ARE USED TO THE EXTENT NATIONAL DEEMS NECESSARY TO SUPPORT NATIONAL'S PRODUCT WARRANTY. EXCEPT WHERE MANDATED BY GOVERNMENT REQUIREMENTS, TESTING OF ALL PARAMETERS OF EACH PRODUCT IS NOT NECESSARILY PERFORMED. NATIONAL ASSUMES NO LIABILITY FOR APPLICATIONS ASSISTANCE OR BUYER PRODUCT DESIGN. BUYERS ARE RESPONSIBLE FOR THEIR PRODUCTS AND APPLICATIONS USING NATIONAL COMPONENTS. PRIOR TO USING OR DISTRIBUTING ANY PRODUCTS THAT INCLUDE NATIONAL COMPONENTS, BUYERS SHOULD PROVIDE ADEQUATE DESIGN, TESTING AND OPERATING SAFEGUARDS.

EXCEPT AS PROVIDED IN NATIONAL'S TERMS AND CONDITIONS OF SALE FOR SUCH PRODUCTS, NATIONAL ASSUMES NO LIABILITY WHATSOEVER, AND NATIONAL DISCLAIMS ANY EXPRESS OR IMPLIED WARRANTY RELATING TO THE SALE AND/OR USE OF NATIONAL PRODUCTS INCLUDING LIABILITY OR WARRANTIES RELATING TO FITNESS FOR A PARTICULAR PURPOSE, MERCHANTABILITY, OR INFRINGEMENT OF ANY PATENT, COPYRIGHT OR OTHER INTELLECTUAL PROPERTY RIGHT.

**LIFE SUPPORT POLICY**

**NATIONAL'S PRODUCTS ARE NOT AUTHORIZED FOR USE AS CRITICAL COMPONENTS IN LIFE SUPPORT DEVICES OR SYSTEMS WITHOUT THE EXPRESS PRIOR WRITTEN APPROVAL OF THE CHIEF EXECUTIVE OFFICER AND GENERAL COUNSEL OF NATIONAL SEMICONDUCTOR CORPORATION.** As used herein:

Life support devices or systems are devices which (a) are intended for surgical implant into the body, or (b) support or sustain life and whose failure to perform when properly used in accordance with instructions for use provided in the labeling can be reasonably expected to result in a significant injury to the user. A critical component is any component in a life support device or system whose failure to perform can be reasonably expected to cause the failure of the life support device or system or to affect its safety or effectiveness.

National Semiconductor and the National Semiconductor logo are registered trademarks of National Semiconductor Corporation. All other brand or product names may be trademarks or registered trademarks of their respective holders.

Copyright© 2007 National Semiconductor Corporation

For the most current product information visit us at [www.national.com](http://www.national.com)



**National Semiconductor Americas Customer Support Center**  
 Email: [new.feedback@nsc.com](mailto:new.feedback@nsc.com)  
 Tel: 1-800-272-9959

**National Semiconductor Europe Customer Support Center**  
 Fax: +49 (0) 180-530-85-86  
 Email: [europe.support@nsc.com](mailto:europe.support@nsc.com)  
 Deutsch Tel: +49 (0) 69 9508 6208  
 English Tel: +49 (0) 870 24 0 2171  
 Français Tel: +33 (0) 1 41 91 8790

**National Semiconductor Asia Pacific Customer Support Center**  
 Email: [ap.support@nsc.com](mailto:ap.support@nsc.com)

**National Semiconductor Japan Customer Support Center**  
 Fax: 81-3-5639-7507  
 Email: [jpn.feedback@nsc.com](mailto:jpn.feedback@nsc.com)  
 Tel: 81-3-5639-7560