

# LM4859 Boomer® Audio Power Amplifier Series

## Stereo 1.2W Audio Sub-system with 3D Enhancement

### General Description

The LM4859 is an integrated audio sub-system designed for stereo cell phone applications. Operating on a 3.3V supply, it combines a stereo speaker amplifier delivering 495mW per channel into an 8Ω load and a stereo headphone amplifier delivering 33mW per channel into a 32Ω load. It integrates the audio amplifiers, volume control, mixer, power management control, and National 3D enhancement all into a single package. In addition, the LM4859 routes and mixes the stereo and mono inputs into 10 distinct output modes. The LM4859 is controlled through an I<sup>2</sup>C compatible interface. Other features include an ultra-low current shutdown mode and thermal shutdown protection.

Boomer audio power amplifiers are designed specifically to provide high quality output power with a minimal amount of external components.

The LM4859 is available in a 28-lead LLP package.

### Key Specifications

■ P <sub>OUT</sub> , Stereo Loudspeakers, 4Ω, 5V, 1% THD+N (LM4859SP)	1.6W (typ)
■ P <sub>OUT</sub> , Stereo Loudspeakers, 8Ω, 5V, 1% THD+N	1.2W (typ)
■ P <sub>OUT</sub> , Stereo Headphones, 32Ω, 5V, 1% THD+N	75mW (typ)
■ P <sub>OUT</sub> , Stereo Loudspeakers, 8Ω, 3.3V, 1% THD+N	495mW (typ)
■ P <sub>OUT</sub> , Stereo Headphones, 32Ω, 3.3V, 1% THD+N	33mW (typ)
■ Shutdown Current	0.06μA (typ)

### Features

- Stereo speaker amplifier
- Stereo headphone amplifier
- Independent Left, Right, and Mono volume controls
- National 3D enhancement
- I<sup>2</sup>C compatible interface
- Ultra low shutdown current
- Click and Pop Suppression circuit
- 10 distinct output modes
- Thermal Shutdown Protection
- Available in an LLP package

### Applications

- Cell Phones
- PDAs
- Portable Gaming Devices
- Internet Appliances
- Portable DVD/CD/AAC/MP3 players

# Typical Application

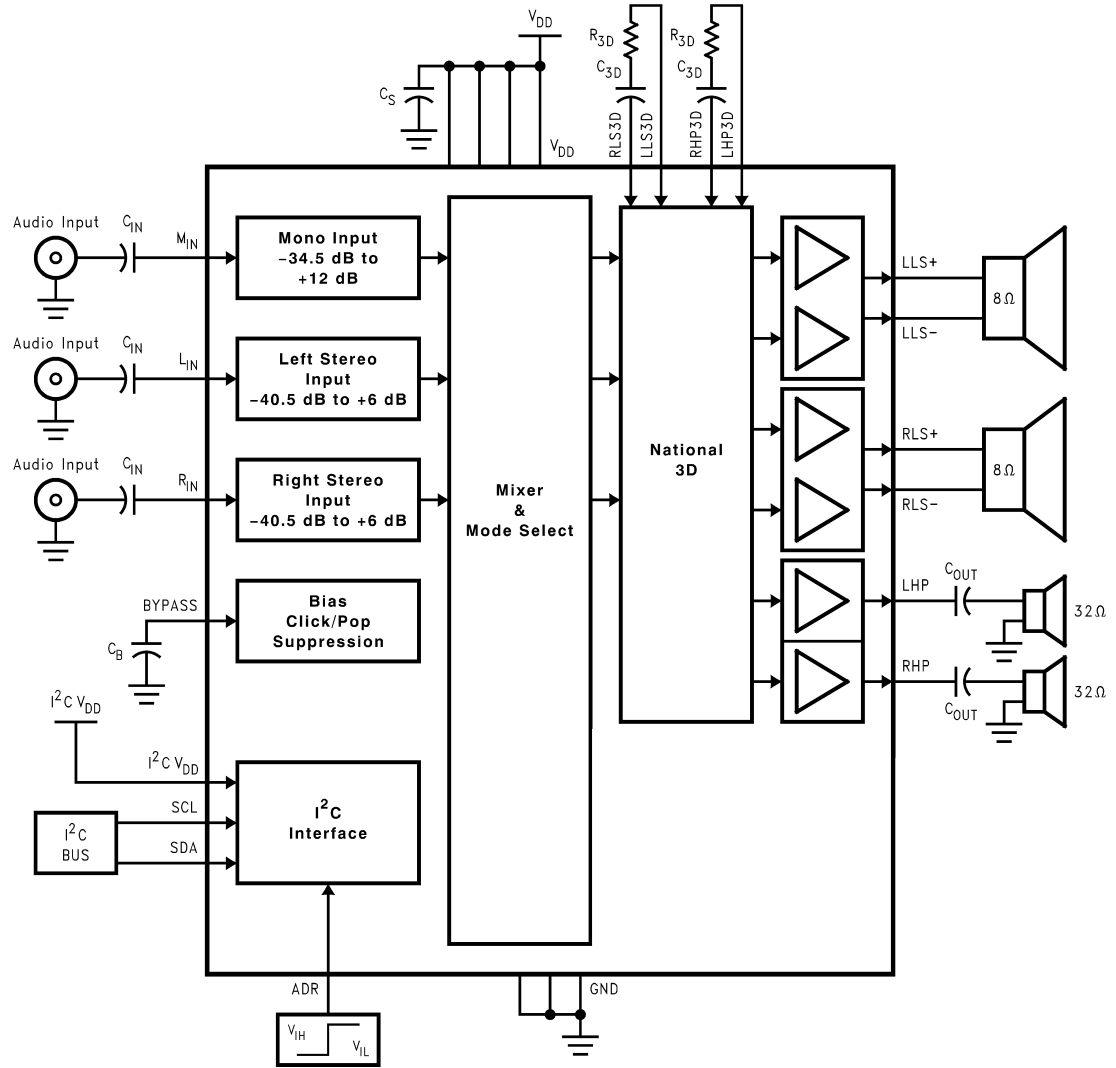

20106101

FIGURE 1. Typical Audio Amplifier Application Circuit

# Connection Diagrams

30 Bump ITL Package

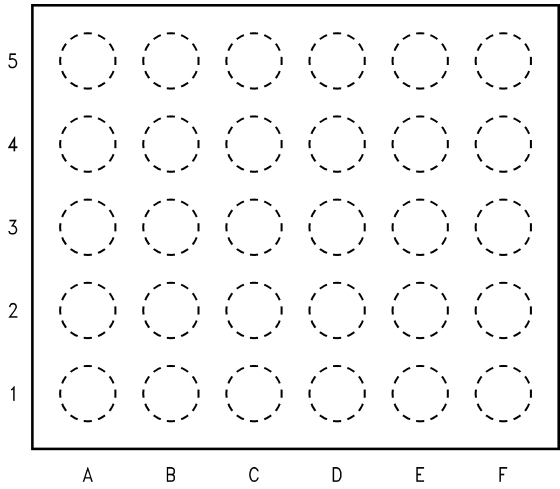

20106108

**Top View**  
**(Bump-side down)**  
**Order Number LM4859ITL**  
**See NS Package Number TLA30CZA**

micro SMD Marking

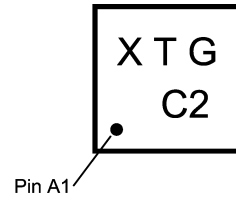

20106109

**Top View**  
**X - Date Code**  
**T - Die Traceability**  
**G - Boomer Family**  
**C2 - LM4859ITL**

## Pin Connection (ITL)

Pin	Name	Pin Description
A1	RLS+	Right Loudspeaker Positive Output
A2	V <sub>DD</sub>	Power Supply
A3	SDA	Data
A4	RHP3D	Right Headphone 3D
A5	RHP	Right Headphone Output
B1	GND	Ground
B2	I <sup>2</sup> C V <sub>DD</sub>	I <sup>2</sup> C Interface Power Supply
B3	ADR	I <sup>2</sup> C Address Select
B4	LHP3D	Left Headphone 3D
B5	V <sub>DD</sub>	Power Supply
C1	RLS-	Right Loudspeaker Negative Output
C2	NC	No Connect
C3	SCL	Clock
C4	NC	No Connect
C5	GND	Ground
D1	LLS-	Left Loudspeaker Negative Output
D2	V <sub>DD</sub>	Power Supply
D3	M <sub>IN</sub>	Mono Input
D4	NC	No Connect
D5	NC	No Connect
E1	GND	Ground
E2	BYPASS	Half-supply bypass
E3	LLS3D	Left Loudspeaker 3D
E4	R <sub>IN</sub>	Right Stereo Input
E5	NC	No Connect
F1	LLS+	Left Loudspeaker Positive Output
F2	V <sub>DD</sub>	Power Supply
F3	RLS3D	Right Loudspeaker 3D
F4	L <sub>IN</sub>	Left Stereo Input
F5	LHP	Left Headphone Output

# Connection Diagram

28 – Lead SP Package

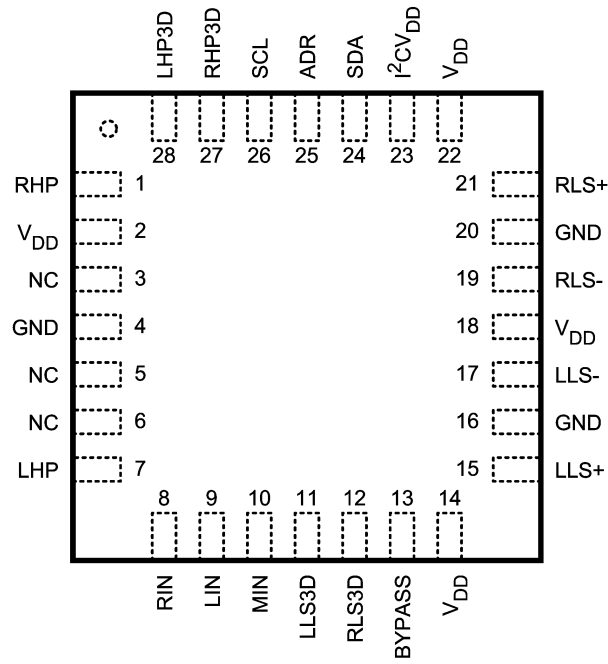

20106199

**Top View**  
**Order Number LM4859SP**  
**See NS Package Number SPA28A**

## Pin Connection (SP)

Pin	Name	Pin Description
1	RHP	Right Headphone Output
2	V <sub>DD</sub>	Power Supply
3	NC	No Connect
4	GND	Ground
5	NC	No Connect
6	NC	No Connect
7	LHP	Left Headphone Output
8	RIN	Right Stereo Input
9	LIN	Left Stereo Input
10	MIN	Mono Input
11	LLS3D	Left Loudspeaker 3D
12	RLS3D	Right Loudspeaker 3D
13	BYPASS	Half-supply bypass
14	V <sub>DD</sub>	Power Supply
15	LLS+	Left Loudspeaker Positive Output
16	GND	Ground
17	LLS-	Left Loudspeaker Negative Output
18	V <sub>DD</sub>	Power Supply
19	RLS-	Right Loudspeaker Negative Output
20	GND	Ground
21	RLS+	Right Loudspeaker Positive Output
22	V <sub>DD</sub>	Power Supply
23	I <sup>2</sup> C V <sub>DD</sub>	I <sup>2</sup> C Interface Power Supply
24	SDA	Data
25	ADR	I <sup>2</sup> C Address Select
26	SCL	Clock
27	RHP3D	Right Headphone 3D
28	LHP3D	Left Headphone 3D

**Absolute Maximum Ratings** (Notes 1, 2)

If Military/Aerospace specified devices are required, please contact the National Semiconductor Sales Office/Distributors for availability and specifications.

Supply Voltage	6.0V
Storage Temperature	-65°C to +150°C
Input Voltage	-0.3V to $V_{DD}$ +0.3V
Power Dissipation (Note 3)	Internally Limited
ESD Susceptibility (Note 4)	2000V
ESD Susceptibility (Note 5)	200V
Junction Temperature ( $T_J$ )	150°C

Thermal Resistance

$\theta_{JA}$ (SPA28A) (Note 10)	42°C/W
$\theta_{JC}$ (SPA28A)	3°C/W

**Operating Ratings**

Temperature Range

$$T_{MIN} \leq T_A \leq T_{MAX} \quad -40^\circ\text{C} \leq T_A \leq +85^\circ\text{C}$$

Supply Voltage

$$2.7\text{V} \leq V_{DD} \leq 5.5\text{V}$$

$$2.5\text{V} \leq I^2CV_{DD} \leq 5.5\text{V}$$

**Audio Amplifier Electrical Characteristics  $V_{DD} = 5.0\text{V}$**  (Notes 1, 2)

The following specifications apply for  $V_{DD} = 5.0\text{V}$ , unless otherwise specified. Limits apply for  $T_A = 25^\circ\text{C}$ .

Symbol	Parameter	Conditions	LM4859		Units (Limits)
			Typical (Note 6)	Limits (Notes 7, 8)	
$I_{DD}$	Supply Current	$V_{IN} = 0\text{V}$ , No load; LD5 = RD5 = 0 (Note 9)			
		Mode 4	5	8	mA (max)
		Mode 2, 3, 7, 8, 12, 13	13	21	mA (max)
$I_{SD}$	Shutdown Current	Output mode 0 (Note 9)	0.2	3	$\mu\text{A}$ (max)
$P_O$	Output Power	LM4859SP Speaker; THD+N = 1%; $f = 1\text{kHz}$ ; 4 $\Omega$ BTL	1.6		W
		Speaker; THD+N = 1%; $f = 1\text{kHz}$ ; 8 $\Omega$ BTL	1.2	0.9	W (min)
		Headphone; THD+N = 1%; $f = 1\text{kHz}$ ; 32 $\Omega$ SE	75	60	mW (min)
THD+N	Total Harmonic Distortion Plus Noise	LD5 = RD5 = 0			
		Speaker; $P_O = 400\text{mW}$ ; $f = 1\text{kHz}$ ; 8 $\Omega$ BTL	0.05		%
		Headphone; $P_O = 15\text{mW}$ ; $f = 1\text{kHz}$ ; 32 $\Omega$ SE	0.04		%
$V_{OS}$	Offset Voltage	Speaker; LD5 = RD5 = 0	5	40	mV (max)
$N_{OUT}$	Output Noise	A-weighted, 0dB gain; (Note 11) LD5 = RD5 = 0; Audio Inputs Terminated			
		Speaker; Mode 2, 3, 7, 8	27		$\mu\text{V}$
		Speaker; Mode 12, 13	38		$\mu\text{V}$
		Headphone; Mode 3, 4, 8, 9	10		$\mu\text{V}$
		Headphone; Mode 13, 14	14		$\mu\text{V}$
PSRR	Power Supply Rejection Ratio	$f = 217\text{Hz}$ ; $V_{rip} = 200\text{mV}_{pp}$ ; $C_B = 2.2\mu\text{F}$ ; 0dB gain; (Note 11) LD5 = RD5 = 0; Audio Inputs Terminated			
		Speaker; Mode 2, 3, 7, 8	70		dB
		Speaker; Mode 12, 13,	64	54	dB (min)
		Headphone; Mode 3, 4, 8, 9	86		dB
		Headphone; Mode 13, 14	73	60	dB (min)

**Audio Amplifier Electrical Characteristics  $V_{DD} = 5.0V$**  (Notes 1, 2) (Continued)The following specifications apply for  $V_{DD} = 5.0V$ , unless otherwise specified. Limits apply for  $T_A = 25^\circ C$ .

Symbol	Parameter	Conditions	LM4859		Units (Limits)
			Typical (Note 6)	Limits (Notes 7, 8)	
Xtalk	Crosstalk	LD5 = RD5 = 0			
		Loudspeaker; $P_O = 400mW$ ; $f = 1kHz$	85		dB
		Headphone; $P_O = 15mW$ ; $f = 1kHz$	85		dB
$T_{WU}$	Wake-up Time	CD5 = 0; $C_B = 2.2\mu F$	120		ms
		CD5 = 1; $C_B = 2.2\mu F$	230		ms

**Audio Amplifier Electrical Characteristics  $V_{DD} = 3.0V$**  (Notes 1, 2)The following specifications apply for  $V_{DD} = 3.0V$ , unless otherwise specified. Limits apply for  $T_A = 25^\circ C$ .

Symbol	Parameter	Conditions	LM4859		Units (Limits)
			Typical (Note 6)	Limits (Notes 7, 8)	
$I_{DD}$	Supply Current	$V_{IN} = 0V$ , No load; LD5 = RD5 = 0 (Note 9)			
		Mode 4	4.5	7.5	mA (max)
		Mode 2, 3, 7, 8, 12, 13	11.2	19	mA (max)
$I_{SD}$	Shutdown Current	Mode 0 (Note 9)	0.06	2.5	$\mu A$ (max)
$P_O$	Output Power	LM4859SP Speaker; THD+N = 1%; $f = 1kHz$ ; $4\Omega$ BTL	530		mW
$P_O$	Output Power	Speaker; THD+N = 1%; $f = 1kHz$ ; $8\Omega$ BTL	400	320	mW (min)
		Headphone; THD+N = 1%; $f = 1kHz$ ; $32\Omega$ SE	25	20	mW (min)
THD+N	Total Harmonic Distortion Plus Noise	LD5 = RD5 = 0			
		Speaker; $P_O = 200mW$ ; $f = 1kHz$ ; $8\Omega$ BTL	0.05		%
		Headphone; $P_O = 10mW$ ; $f = 1kHz$ ; $32\Omega$ SE	0.04		%
$V_{OS}$	Offset Voltage	Speaker; LD5 = RD5 = 0	5	40	mV (max)
$N_{OUT}$	Output Noise	A-weighted; 0dB gain; (Note 11) LD5 = RD5 = 0; All Inputs Terminated			
		Speaker; Mode 2, 3, 7, 8	27		$\mu V$
		Speaker; Mode 12, 13	38		$\mu V$
		Headphone; Mode 3, 4, 8, 9	10		$\mu V$
		Headphone; Mode 13, 14	14		$\mu V$
PSRR	Power Supply Rejection Ratio	$f = 217Hz$ , $V_{rip} = 200mV_{pp}$ ; $C_B = 2.2\mu F$ ; 0dB gain; (Note 11) LD5 = RD5 = 0; All Audio Inputs Terminated			
		Speaker; Mode 2, 3, 7, 8	70		dB
		Speaker; Mode 12, 13,	65	55	dB (min)
		Headphone; Mode 3, 4, 8, 9	87		dB
		Headphone; Mode 13, 14	75	62	dB (min)



**Audio Amplifier Electrical Characteristics  $V_{DD} = 3.0V$**  (Notes 1, 2) (Continued)The following specifications apply for  $V_{DD} = 3.0V$ , unless otherwise specified. Limits apply for  $T_A = 25^\circ C$ .

Symbol	Parameter	Conditions	LM4859		Units (Limits)
			Typical (Note 6)	Limits (Notes 7, 8)	
Xtalk	Crosstalk	LD5 = RD5 = 0			
		Loudspeaker; $P_O = 200mW$ ; $f = 1kHz$	82		dB
		Headphone; $P_O = 10mW$ ; $f = 1kHz$	82		dB
$T_{WU}$	Wake-up Time	CD5 = 0; $C_B = 2.2\mu F$	80		ms
		CD5 = 1; $C_B = 2.2\mu F$	140		ms

**Volume Control Electrical Characteristics** (Notes 1, 2)The following specifications apply for  $V_{DD} = 5.0V$  and  $V_{DD} = 3.0V$ , unless otherwise specified. Limits apply for  $T_A = 25^\circ C$ .

Symbol	Parameter	Conditions	LM4859		Units (Limits)
			Typical (Note 6)	Limits (Notes 7, 8)	
	Stereo Volume Control Range	maximum gain setting	6	5.5 6.5	dB (min) dB (max)
		minimum gain setting	-40.5	-41 -40	dB (min) dB (max)
	Mono Volume Control Range	maximum gain setting	12	11.5 12.5	dB (min) dB (max)
		minimum gain setting	-34.5	-35 -34	dB (min) dB (max)
	Volume Control Step Size		1.5		dB
	Volume Control Step Size Error		+/-0.2	+/-0.5	dB (max)
	Stereo Channel to Channel Gain Mismatch		0.3		dB
	Mute Attenuation	Mode 12, $V_{in} = 1V_{RMS}$			
		Headphone	85		dB
	$L_{IN}$ and $R_{IN}$ Input Impedance	maximum gain setting	33.5	25 42	$k\Omega$ (min) $k\Omega$ (max)
		minimum gain setting	100	75 125	$k\Omega$ (min) $k\Omega$ (max)
	$M_{IN}$ Input Impedance	maximum gain setting	20	15 25	$k\Omega$ (min) $k\Omega$ (max)
		minimum gain setting	98	73 123	$k\Omega$ (min) $k\Omega$ (max)

**Control Interface Electrical Characteristics** (Notes 1, 2)The following specifications apply for  $V_{DD} = 5V$  and  $V_{DD} = 3V$  and  $2.5V \leq I^2CV_{DD} \leq 5.5V$ , unless otherwise specified. Limits apply for  $T_A = 25^\circ C$ .

Symbol	Parameter	Conditions	LM4859		Units (Limits)
			Typical (Note 6)	Limits (Notes 7, 8)	
$t_1$	SCL period			2.5	$\mu s$ (min)
$t_2$	SDA Set-up Time			100	ns (min)
$t_3$	SDA Stable Time			0	ns (min)
$t_4$	Start Condition Time			100	ns (min)
$t_5$	Stop Condition time			100	ns (min)

## Control Interface Electrical Characteristics (Notes 1, 2) (Continued)

The following specifications apply for  $V_{DD} = 5V$  and  $V_{DD} = 3V$  and  $2.5V \leq I^2CV_{DD} \leq 5.5V$ , unless otherwise specified. Limits apply for  $T_A = 25^\circ C$ .

Symbol	Parameter	Conditions	LM4859		Units (Limits)
			Typical (Note 6)	Limits (Notes 7, 8)	
$V_{IH}$	Digital Input High Voltage			$0.7 \times I^2CV_{DD}$	V (min)
$V_{IL}$	Digital Input Low Voltage			$0.3 \times I^2CV_{DD}$	V (max)

**Note 1:** All voltages are measured with respect to the GND pin unless otherwise specified.

**Note 2:** Absolute Maximum Ratings indicate limits beyond which damage to the device may occur. Operating Ratings indicate conditions for which the device is functional but do not guarantee specific performance limits. Electrical Characteristics state DC and AC electrical specifications under particular test conditions which guarantee specific performance limits. This assumes that the device is within the Operating Ratings. Specifications are not guaranteed for parameters where no limit is given, however, the typical value is a good indication of device performance.

**Note 3:** The maximum power dissipation must be derated at elevated temperatures and is dictated by  $T_{JMAX}$ ,  $\theta_{JA}$ , and the ambient temperature,  $T_A$ . The maximum allowable power dissipation is  $P_{DMAX} = (T_{JMAX} - T_A) / \theta_{JA}$  or the number given in Absolute Maximum Ratings, whichever is lower. For the LM4859 operating in Mode 3, 8, or 13 with  $V_{DD} = 5V$ ,  $8\Omega$  stereo loudspeakers and  $32\Omega$  stereo headphones, the total power dissipation is 1.348W.  $\theta_{JA} = 62^\circ C/W$ .

**Note 4:** Human body model, 100pF discharged through a 1.5k $\Omega$  resistor.

**Note 5:** Machine Model, 220pF-240pF discharged through all pins.

**Note 6:** Typicals are measured at  $+25^\circ C$  and represent the parametric norm.

**Note 7:** Limits are guaranteed to National's AOQL (Average Outgoing Quality Level).

**Note 8:** Datasheet min/max specification limits are guaranteed by design, test, or statistical analysis.

**Note 9:** Shutdown current and supply current are measured in a normal room environment. All digital input pins are connected to  $I^2CV_{DD}$ .

**Note 10:** The given  $\theta_A$  is for an LM4859SP mounted on a PCB with a 2in<sup>2</sup> area of 10z printed circuit board ground plane.

**Note 11:** "0dB gain" refers to the volume control gain setting of  $M_{IN}$ ,  $L_{IN}$ , and  $R_{IN}$  set at 0dB.

## External Components Description

Components		Functional Description
1.	$C_{IN}$	This is the input coupling capacitor. It blocks the DC voltage and couples the input signal to the amplifier's input terminals. $C_{IN}$ also creates a highpass filter with the internal resistor $R_i$ (Input Impedance) at $f_c = 1/(2\pi R_i C_{IN})$ .
2.	$C_S$	This is the supply bypass capacitor. It filters the supply voltage applied to the $V_{DD}$ pin and helps reduce the noise at the $V_{DD}$ pin.
3.	$C_B$	This is the BYPASS pin capacitor. It filters the $V_{DD} / 2$ voltage and helps maintain the LM4859's PSRR.
4.	$C_{OUT}$	This is the output coupling capacitor. It blocks the DC voltage and couples the output signal to the speaker load $R_L$ . $C_{OUT}$ also creates a high pass filter with $R_L$ at $f_o = 1/(2\pi R_L C_{OUT})$ .
5.	$R_{3D}$	This resistor sets the gain of the National 3D effect. Please refer to the <b>National 3D Enhancement</b> section for information on selecting the value of $R_{3D}$ .
6.	$C_{3D}$	This capacitor sets the frequency at which the National 3D effect starts to occur. Please refer to the <b>National 3D Enhancement</b> section for information on selecting the value of $C_{3D}$ .

## Typical Performance Characteristics (Note 11)

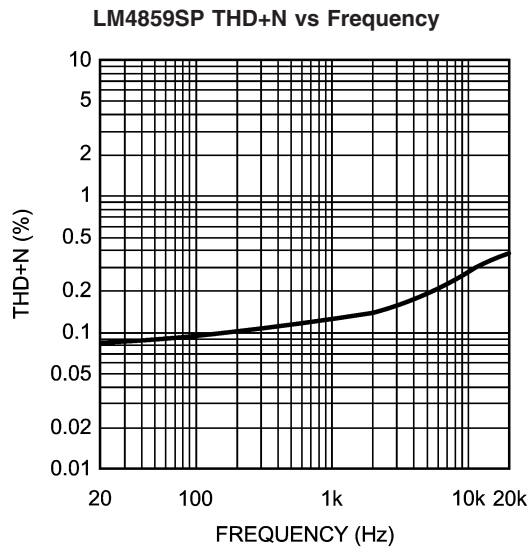

20106155

$V_{DD} = 5V$ ; LLS, RLS;  $P_O = 400mW$ ;  
 $R_L = 4\Omega$ ; Mode 7; 0dB Gain

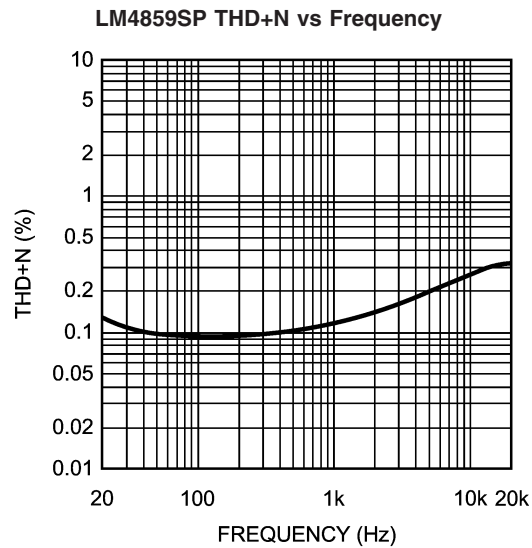

20106156

$V_{DD} = 3V$ ; LLS, RLS;  $P_O = 200mW$ ;  
 $R_L = 4\Omega$ ; Mode 7; 0dB Gain

Typical Performance Characteristics (Note 11) (Continued)

LM4859SP THD+N vs Output Power

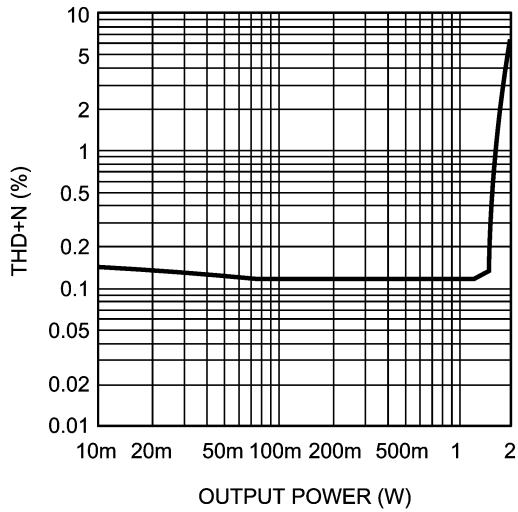

20106157

$V_{DD} = 5V$ ; LLS, RLS;  $f = 1kHz$ ;  
 $R_L = 4\Omega$ ; Mode 7; 0dB Gain

LM4859SP THD+N vs Output Power

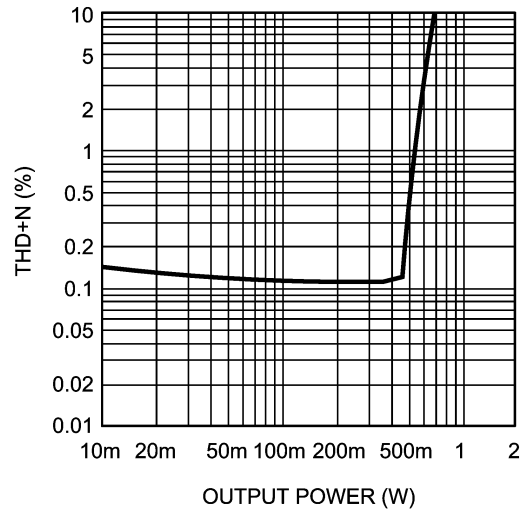

20106158

$V_{DD} = 3V$ ; LLS, RLS;  $f = 1kHz$ ;  
 $R_L = 4\Omega$ ; Mode 7; 0dB Gain

THD+N vs Frequency

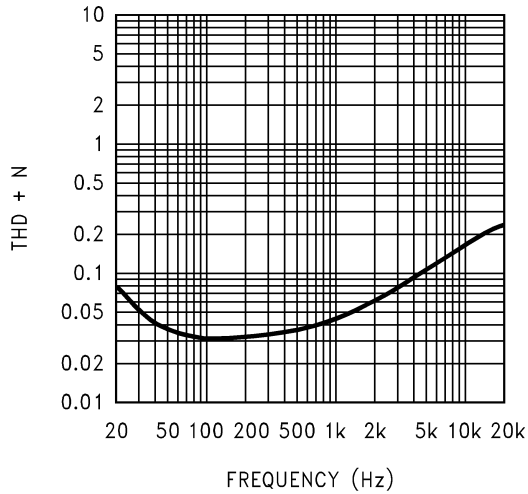

20106110

$V_{DD} = 5V$ ; LLS, RLS;  $P_O = 400mW$ ;  
 $R_L = 8\Omega$ ; Mode 7; 0dB Gain

THD+N vs Frequency

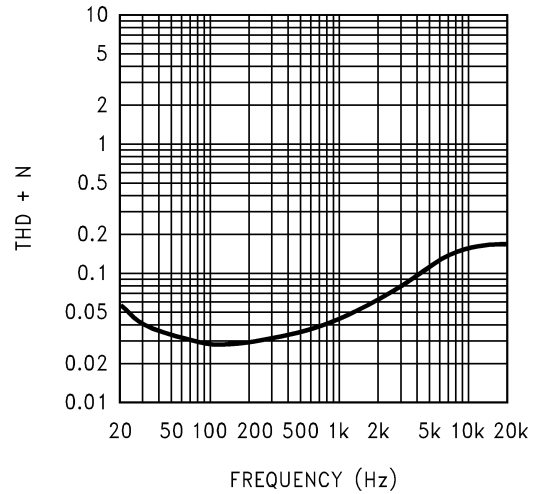

20106111

$V_{DD} = 3V$ ; LLS, RLS;  $P_O = 200mW$ ;  
 $R_L = 8\Omega$ ; Mode 7; 0dB Gain

Typical Performance Characteristics (Note 11) (Continued)

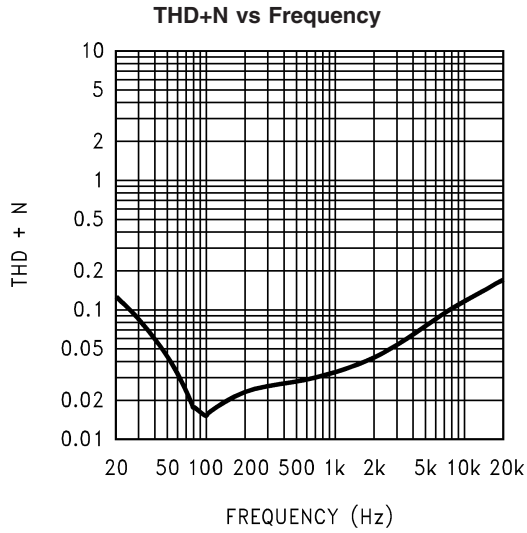

20106112  
 $V_{DD} = 5V$ ; LHP, RHP;  $P_O = 15mW$ ;  
 $R_L = 32\Omega$ ; Mode 9; 0dB Gain

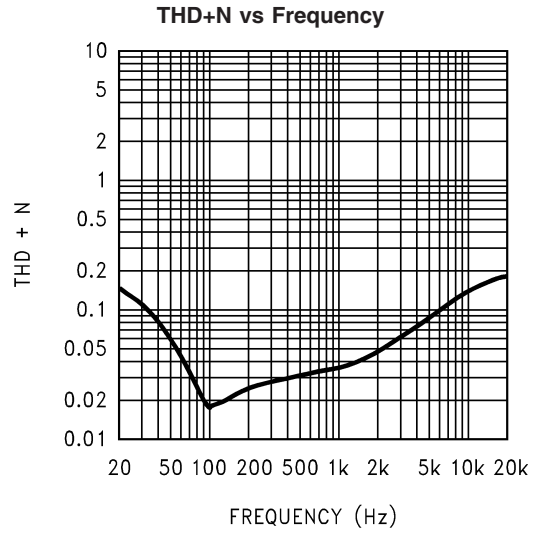

20106113  
 $V_{DD} = 3V$ ; LHP, RHP;  $P_O = 10mW$ ;  
 $R_L = 32\Omega$ ; Mode 9; 0dB Gain

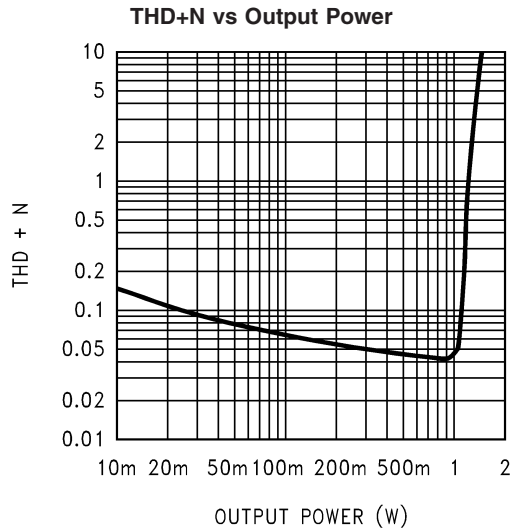

20106120  
 $V_{DD} = 5V$ ; LLS, RLS;  $f = 1kHz$ ;  
 $R_L = 8\Omega$ ; Mode 7; 0dB Gain

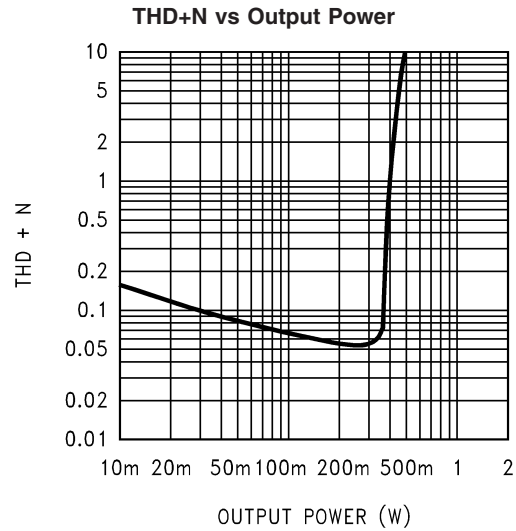

20106121  
 $V_{DD} = 3V$ ; LLS, RLS;  $f = 1kHz$ ;  
 $R_L = 8\Omega$ ; Mode 7; 0dB Gain

Typical Performance Characteristics (Note 11) (Continued)

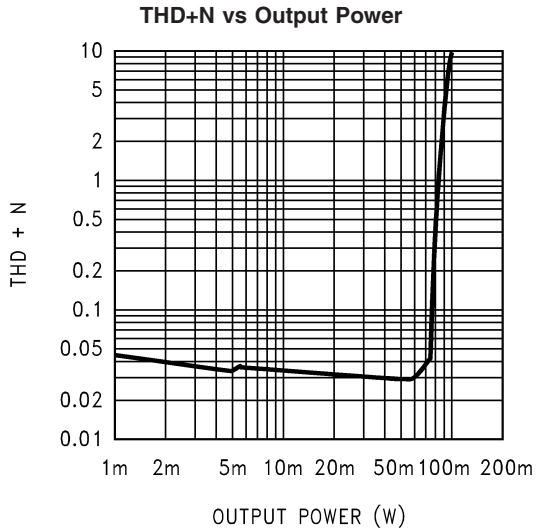

$V_{DD} = 5V$ ; LHP, RHP;  $f = 1kHz$ ;  
 $R_L = 32\Omega$ ; Mode 9; 0dB Gain

20106122

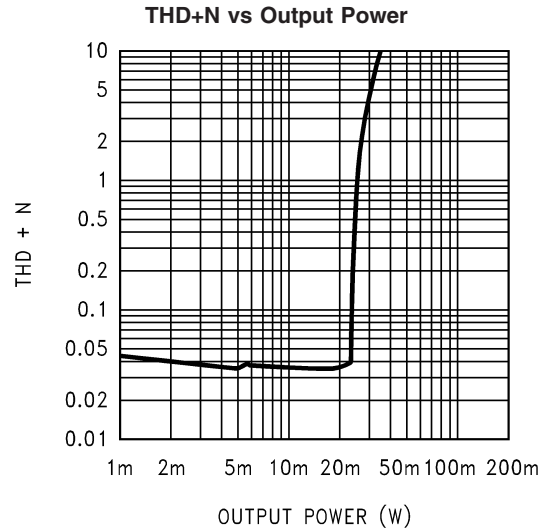

$V_{DD} = 3V$ ; LHP, RHP;  $f = 1kHz$ ;  
 $R_L = 32\Omega$ ; Mode 9; 0dB Gain

20106123

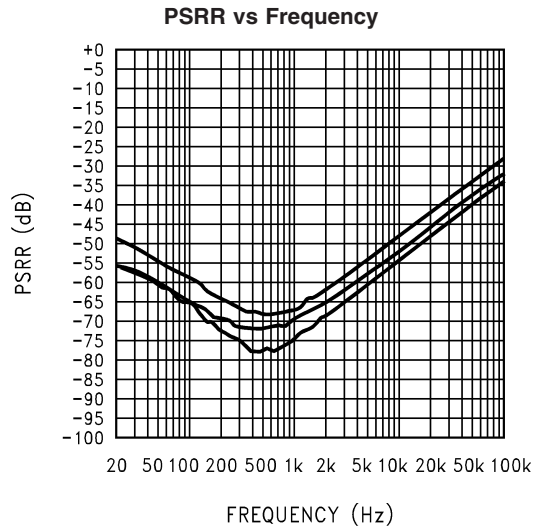

$V_{DD} = 5V$ ; LLS, RLS;  $R_L = 8\Omega$ ; 0db Gain;  
All audio inputs terminated  
Top-Mode 12, 13; Mid-Mode 2, 3; Bot-Mode 7, 8

20106126

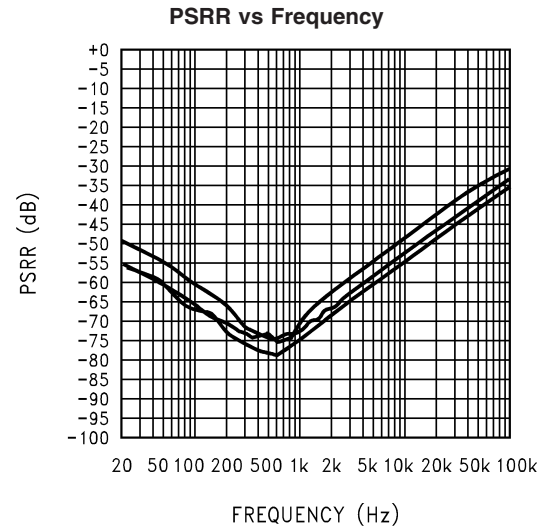

$V_{DD} = 3V$ ; LLS, RLS;  $R_L = 8\Omega$ ; 0db Gain;  
All audio inputs terminated  
Top-Mode 12, 13; Mid-Mode 2, 3; Bot-Mode 7, 8

20106127

Typical Performance Characteristics (Note 11) (Continued)

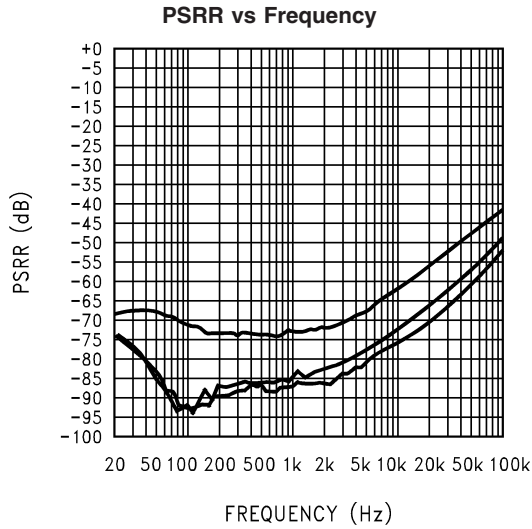

20106128  
 **$V_{DD} = 5V$ ; LHP, RHP;  $R_L = 32\Omega$ ; 0db Gain;**  
**All audio inputs terminated**  
**Top-Mode 13, 14; Mid-Mode 3, 4; Bot-Mode 8, 9**

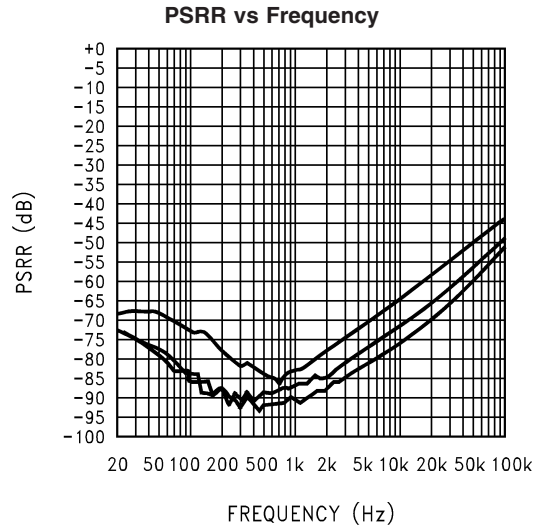

20106129  
 **$V_{DD} = 3V$ ; LHP, RHP;  $R_L = 32\Omega$ ; 0db Gain;**  
**All audio inputs terminated**  
**Top-Mode 13, 14; Mid-Mode 3, 4; Bot-Mode 8, 9**

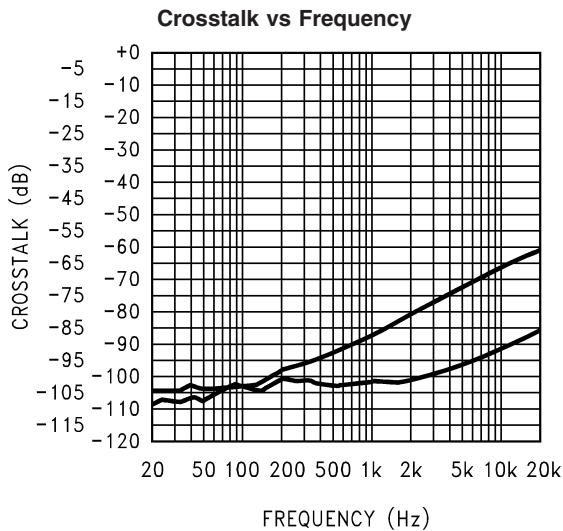

20106134  
 **$V_{DD} = 5V$ ; LLS, RLS;  $P_O = 400mW$ ;  $R_L = 8\Omega$ ;**  
**Mode 7; 0db Gain; 3D off**  
**Top-Left to Right; Bot- Right to Left**

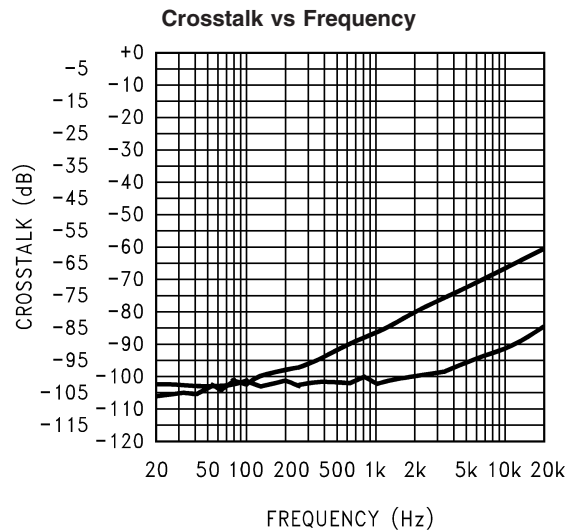

20106135  
 **$V_{DD} = 3V$ ; LLS, RLS;  $P_O = 200mW$ ;  $R_L = 8\Omega$ ;**  
**Mode 7; 0db Gain; 3D off**  
**Top-Left to Right; Bot- Right to Left**

Typical Performance Characteristics (Note 11) (Continued)

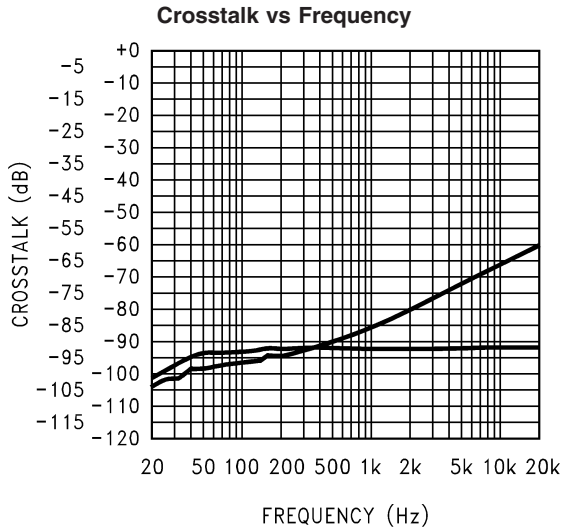

20106136  
**V<sub>DD</sub> = 5V; LHP, RHP; P<sub>O</sub> = 15mW; R<sub>L</sub> = 32Ω;**  
**Mode 9; 0db Gain; 3D off**  
**Top-Left to Right; Bot- Right to Left**

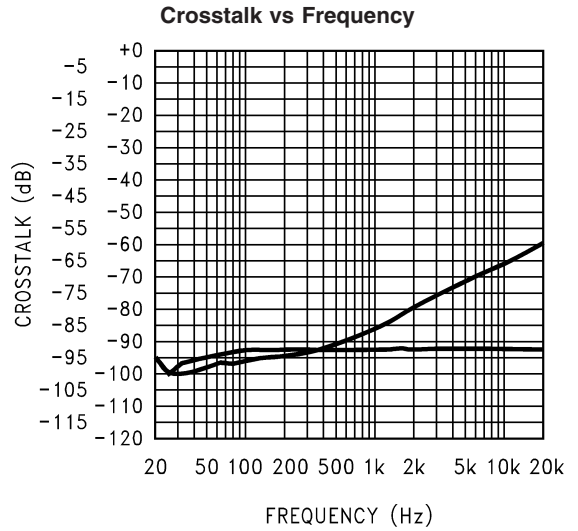

20106137  
**V<sub>DD</sub> = 3V; LHP, RHP; P<sub>O</sub> = 10mW; R<sub>L</sub> = 32Ω;**  
**Mode 9; 0db Gain; 3D off**  
**Top-Left to Right; Bot- Right to Left**

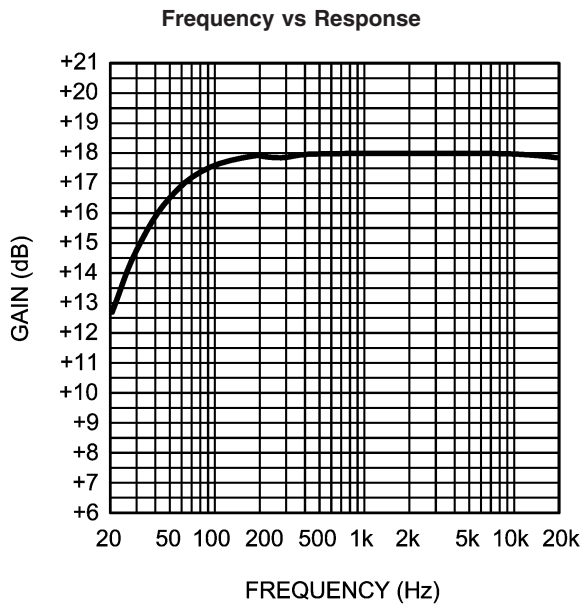

20106138  
**LLS, RLS; R<sub>L</sub> = 8Ω;**  
**Mode 2; Full Gain**

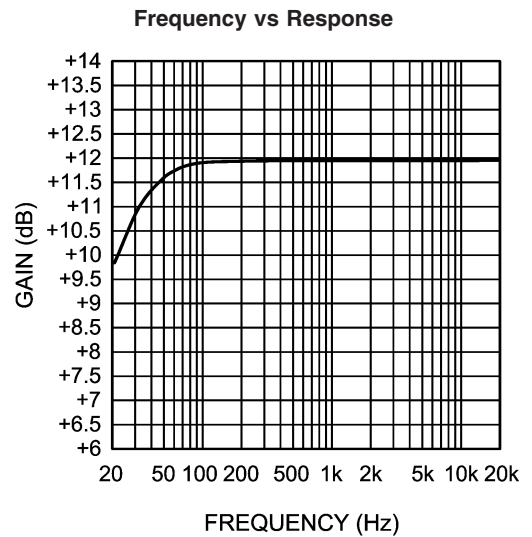

20106139  
**LLS, RLS; R<sub>L</sub> = 8Ω;**  
**Mode 7; Full Gain**



Typical Performance Characteristics (Note 11) (Continued)

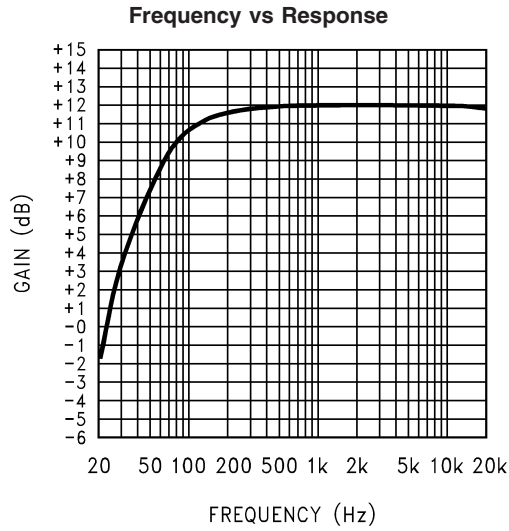

LHP, RHP;  $R_L = 32\Omega$ ;  $C_O = 100\mu F$   
Mode 4; Full Gain

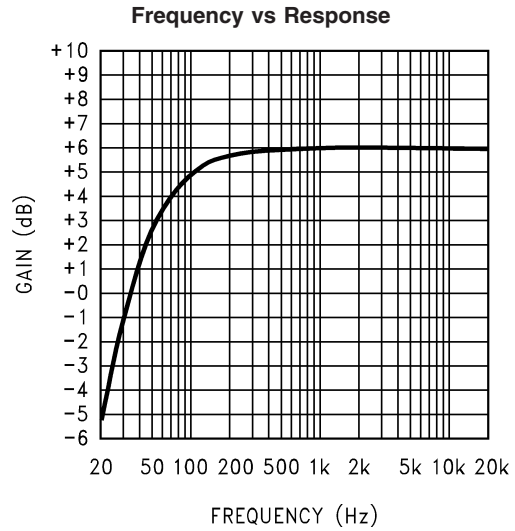

LHP, RHP;  $R_L = 32\Omega$ ;  $C_O = 100\mu F$   
Mode 9; Full Gain

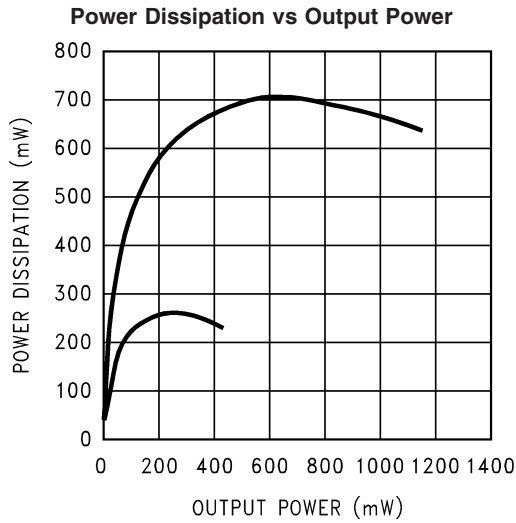

LLS, RLS;  $R_L = 8\Omega$ ;  $THD+N \leq 1\%$   
 $Top-V_{DD} = 5V$ ;  $Bot-V_{DD} = 3V$   
per channel

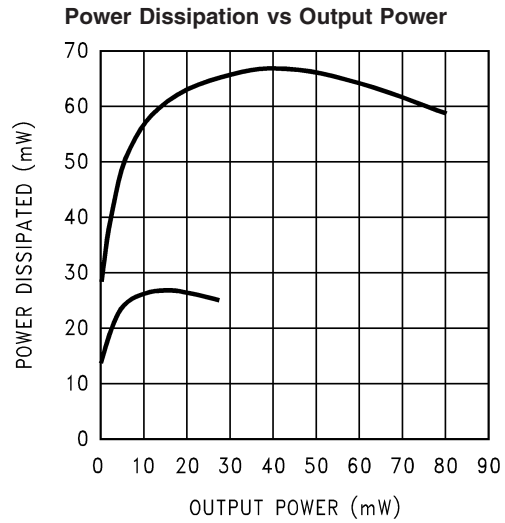

LHP, RHP;  $R_L = 32\Omega$ ;  $THD+N \leq 1\%$   
 $Top-V_{DD} = 5V$ ;  $Bot-V_{DD} = 3V$   
per channel

Typical Performance Characteristics (Note 11) (Continued)

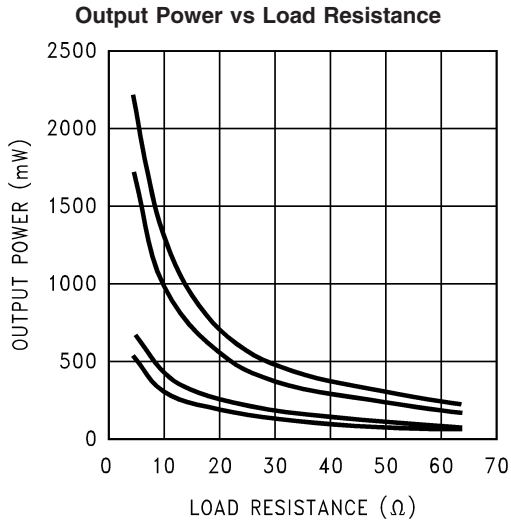

20106148

LLS, RLS;  $R_L = 8\Omega$ ;  
 Top- $V_{DD} = 5V$ , 10% THD+N; Topmid- $V_{DD} = 5V$ , 1% THD+N;  
 Botmid- $V_{DD} = 3V$ , 10% THD+N; Bot- $V_{DD} = 3V$ , 1% THD+N

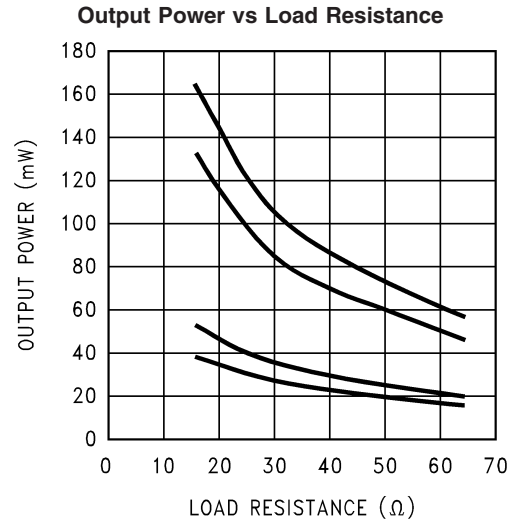

20106149

LHP, RHP;  $R_L = 32\Omega$ ;  
 Top- $V_{DD} = 5V$ , 10% THD+N; Topmid- $V_{DD} = 5V$ , 1% THD+N;  
 Botmid- $V_{DD} = 3V$ , 10% THD+N; Bot- $V_{DD} = 3V$ , 1% THD+N

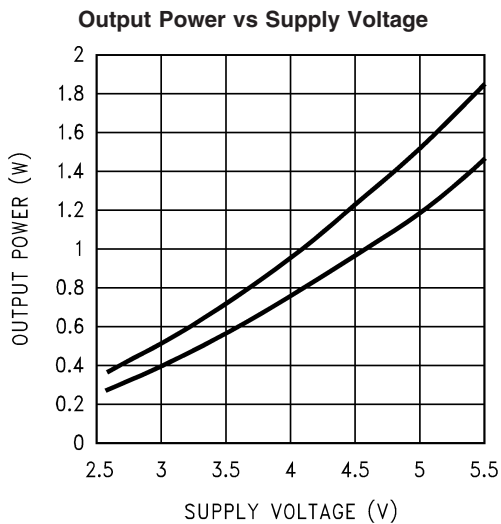

20106152

LLS, RLS;  $R_L = 8\Omega$ ;  
 Top-10% THD+N; Bot-1% THD+N

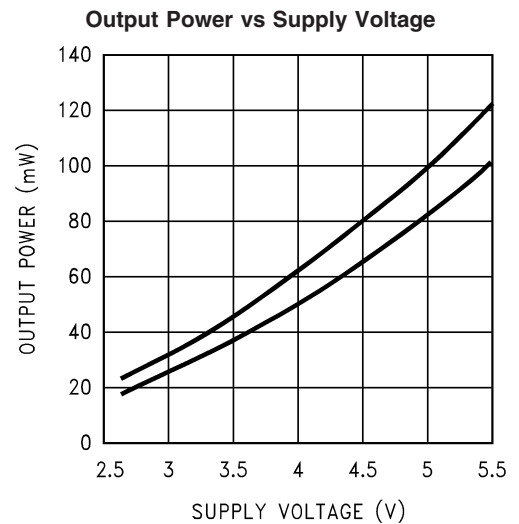

20106153

LHP, RHP;  $R_L = 32\Omega$ ;  
 Top-10% THD+N; Bot-1% THD+N

# Application Information

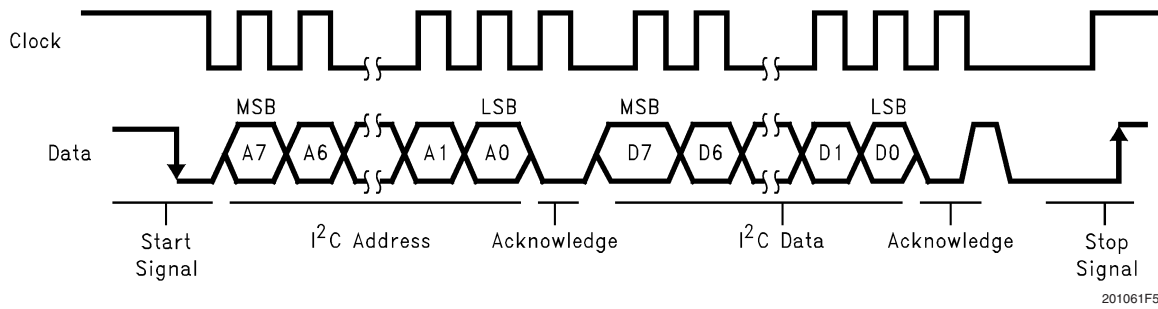

FIGURE 2. I<sup>2</sup>C Bus Format

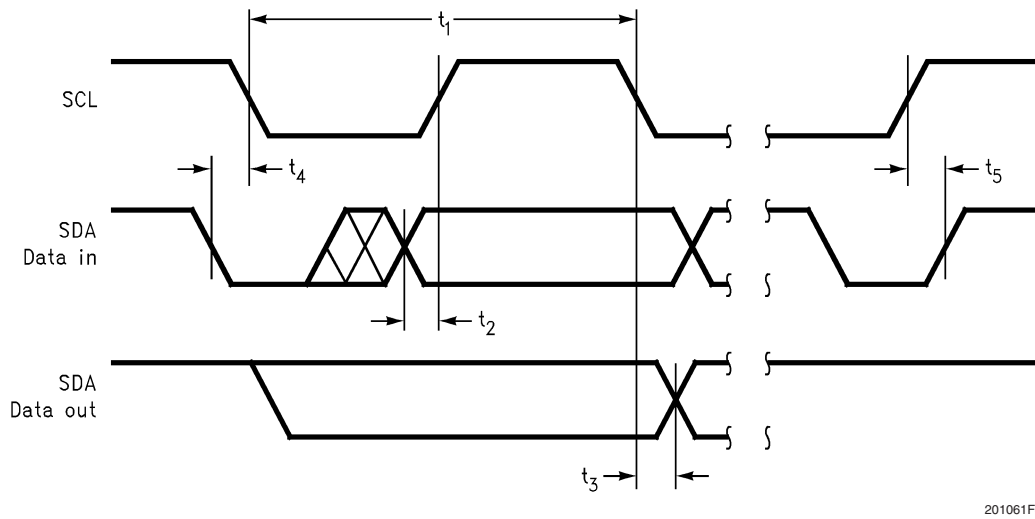

FIGURE 3. I<sup>2</sup>C Timing Diagram

TABLE 1. Chip Address

	A7	A6	A5	A4	A3	A2	A1	A0
Chip Address	1	1	1	1	1	0	EC	0
ADR = 0	1	1	1	1	1	0	0	0
ADR = 1	1	1	1	1	1	0	1	0

EC - externally configured by ADR pin

TABLE 2. Control Registers

	D7	D6	D5	D4	D3	D2	D1	D0
Mono Volume control	0	0	0	MD4	MD3	MD2	MD1	MD0
Left Volume control	0	1	LD5	LD4	LD3	LD2	LD1	LD0
Right Volume control	1	0	RD5	RD4	RD3	RD2	RD1	RD0
Mode control	1	1	CD5	0	CD3	CD2	CD1	CD0

# Application Information (Continued)

**TABLE 3. Mono Volume Control**

MD4	MD3	MD2	MD1	MD0	Gain (dB)
0	0	0	0	0	-34.5
0	0	0	0	1	-33.0
0	0	0	1	0	-31.5
0	0	0	1	1	-30.0
0	0	1	0	0	-28.5
0	0	1	0	1	-27.0
0	0	1	1	0	-25.5
0	0	1	1	1	-24.0
0	1	0	0	0	-22.5
0	1	0	0	1	-21.0
0	1	0	1	0	-19.5
0	1	0	1	1	-18.0
0	1	1	0	0	-16.5
0	1	1	0	1	-15.0
0	1	1	1	0	-13.5
0	1	1	1	1	-12.0
1	0	0	0	0	-10.5
1	0	0	0	1	-9.0
1	0	0	1	0	-7.5
1	0	0	1	1	-6.0
1	0	1	0	0	-4.5
1	0	1	0	1	-3.0
1	0	1	1	0	-1.5
1	0	1	1	1	0.0
1	1	0	0	0	1.5
1	1	0	0	1	3.0
1	1	0	1	0	4.5
1	1	0	1	1	6.0
1	1	1	0	0	7.5
1	1	1	0	1	9.0
1	1	1	1	0	10.5
1	1	1	1	1	12.0

# Application Information (Continued)

**TABLE 4. Stereo Volume Control**

LD4//RD4	LD3//RD3	LD2//RD2	LD1//RD1	LD0//RD0	Gain (dB)
0	0	0	0	0	-40.5
0	0	0	0	1	-39.0
0	0	0	1	0	-37.5
0	0	0	1	1	-36.0
0	0	1	0	0	-34.5
0	0	1	0	1	-33.0
0	0	1	1	0	-31.5
0	0	1	1	1	-30.0
0	1	0	0	0	-28.5
0	1	0	0	1	-27.0
0	1	0	1	0	-25.5
0	1	0	1	1	-24.0
0	1	1	0	0	-22.5
0	1	1	0	1	-21.0
0	1	1	1	0	-19.5
0	1	1	1	1	-18.0
1	0	0	0	0	-16.5
1	0	0	0	1	-15.0
1	0	0	1	0	-13.5
1	0	0	1	1	-12.0
1	0	1	0	0	-10.5
1	0	1	0	1	-9.0
1	0	1	1	0	-7.5
1	0	1	1	1	-6.0
1	1	0	0	0	-4.5
1	1	0	0	1	-3.0
1	1	0	1	0	-1.5
1	1	0	1	1	0.0
1	1	1	0	0	1.5
1	1	1	0	1	3.0
1	1	1	1	0	4.5
1	1	1	1	1	6.0

## Application Information (Continued)

**TABLE 5. Mixer and Output Mode**

Mode	CD3	CD2	CD1	CD0	Loudspeaker L	Loudspeaker R	Headphone L	Headphone R
0	0	0	0	0	SD	SD	SD	SD
1	0	0	0	1	RESERVED			
2	0	0	1	0	$2(G_M \times M)$	$2(G_M \times M)$	MUTE	MUTE
3	0	0	1	1	$2(G_M \times M)$	$2(G_M \times M)$	$(G_M \times M)$	$(G_M \times M)$
4	0	1	0	0	SD	SD	$(G_M \times M)$	$(G_M \times M)$
5	0	1	0	1	RESERVED			
6	0	1	1	0	RESERVED			
7	0	1	1	1	$2(G_L \times L)$	$2(G_R \times R)$	MUTE	MUTE
8	1	0	0	0	$2(G_L \times L)$	$2(G_R \times R)$	$(G_L \times L)$	$(G_R \times R)$
9	1	0	0	1	SD	SD	$(G_L \times L)$	$(G_R \times R)$
10	1	0	1	0	RESERVED			
11	1	0	1	1	RESERVED			
12	1	1	0	0	$2(G_L \times L) + 2(G_M \times M)$	$2(G_R \times R) + 2(G_M \times M)$	MUTE	MUTE
13	1	1	0	1	$2(G_L \times L) + 2(G_M \times M)$	$2(G_R \times R) + 2(G_M \times M)$	$(G_L \times L) + (G_M \times M)$	$(G_R \times R) + (G_M \times M)$
14	1	1	1	0	SD	SD	$(G_L \times L) + (G_M \times M)$	$(G_R \times R) + (G_M \times M)$
15	1	1	1	1	RESERVED			

M -  $M_{IN}$  Input LevelL -  $L_{IN}$  Input LevelR -  $R_{IN}$  Input Level $G_M$  - Mono Volume Control Gain $G_L$  - Left Stereo Volume Control Gain $G_R$  - Right Stereo Volume Control Gain

SD - Shutdown

MUTE - Mute

**TABLE 6. National 3D Enhancement**

LD5	0	Loudspeaker National 3D Off
	1	Loudspeaker National 3D On
RD5	0	Headphone National 3D Off
	1	Headphone National 3D On

**TABLE 7. Wake-up Time Select**

CD5	0	Fast Wake-up Setting
	1	Slow Wake-up Setting

## Application Information (Continued)

### I<sup>2</sup>C COMPATIBLE INTERFACE

The LM4859 uses a serial bus, which conforms to the I<sup>2</sup>C protocol, to control the chip's functions with two wires: clock (SCL) and data (SDA). The clock line is uni-directional. The data line is bi-directional (open-collector). The maximum clock frequency specified by the I<sup>2</sup>C standard is 400kHz. In this discussion, the master is the controlling microcontroller and the slave is the LM4859.

The I<sup>2</sup>C address for the LM4859 is determined using the ADR pin. The LM4859's two possible I<sup>2</sup>C chip addresses are of the form 11110X<sub>1</sub>0 (binary), where X<sub>1</sub> = 0, if ADR is logic low; and X<sub>1</sub> = 1, if ADR is logic high. If the I<sup>2</sup>C interface is used to address a number of chips in a system, the LM4859's chip address can be changed to avoid any possible address conflicts.

The bus format for the I<sup>2</sup>C interface is shown in Figure 2. The bus format diagram is broken up into six major sections:

The "start" signal is generated by lowering the data signal while the clock signal is high. The start signal will alert all devices attached to the I<sup>2</sup>C bus to check the incoming address against their own address.

The 8-bit chip address is sent next, most significant bit first. The data is latched in on the rising edge of the clock. Each address bit must be stable while the clock level is high.

After the last bit of the address bit is sent, the master releases the data line high (through a pull-up resistor). Then the master sends an acknowledge clock pulse. If the LM4859 has received the address correctly, then it holds the data line low during the clock pulse. If the data line is not held low during the acknowledge clock pulse, then the master should abort the rest of the data transfer to the LM4859.

The 8 bits of data are sent next, most significant bit first. Each data bit should be valid while the clock level is stable high.

After the data byte is sent, the master must check for another acknowledge to see if the LM4859 received the data.

If the master has more data bytes to send to the LM4859, then the master can repeat the previous two steps until all data bytes have been sent.

The "stop" signal ends the transfer. To signal "stop", the data signal goes high while the clock signal is high. The data line should be held high when not in use.

### I<sup>2</sup>C INTERFACE POWER SUPPLY PIN (I<sup>2</sup>CV<sub>DD</sub>)

The LM4859's I<sup>2</sup>C interface is powered up through the I<sup>2</sup>CV<sub>DD</sub> pin. The LM4859's I<sup>2</sup>C interface operates at a voltage level set by the I<sup>2</sup>CV<sub>DD</sub> pin which can be set independent to that of the main power supply pin V<sub>DD</sub>. This is ideal whenever logic levels for the I<sup>2</sup>C interface are dictated by a microcontroller or microprocessor that is operating at a lower supply voltage than the main battery of a portable system.

### NATIONAL 3D ENHANCEMENT

The LM4859 features a 3D audio enhancement effect that widens the perceived soundstage from a stereo audio signal. The 3D audio enhancement improves the apparent stereo channel separation whenever the left and right speakers are too close to one another, due to system size constraints or equipment limitations.

An external RC network, shown in Figure 1, is required to enable the 3D effect. There are separate RC networks for

both the stereo loudspeaker outputs as well as the stereo headphone outputs, so the 3D effect can be set independently for each set of stereo outputs.

The amount of the 3D effect is set by the R<sub>3D</sub> resistor. Decreasing the value of R<sub>3D</sub> will increase the 3D effect. The C<sub>3D</sub> capacitor sets the low cutoff frequency of the 3D effect. Increasing the value of C<sub>3D</sub> will decrease the low cutoff frequency at which the 3D effect starts to occur, as shown by Equation 1.

$$f_{3D(-3dB)} = 1 / 2\pi(R_{3D})(C_{3D}) \quad (1)$$

Activating the 3D effect will cause an increase in gain by a multiplication factor of  $(1 + 20k\Omega/R_{3D})$ . Setting R<sub>3D</sub> to 20kΩ will result in a gain increase by a multiplication factor of  $(1+20k\Omega/20k\Omega) = 2$  or 6dB whenever the 3D effect is activated. The volume control can be programmed through the I<sup>2</sup>C compatible interface to compensate for the extra 6dB increase in gain. For example, if the stereo volume control is set at 0dB (11011 from Table 4) before the 3D effect is activated, the volume control should be programmed to -6dB (10111 from Table 4) immediately after the 3D effect has been activated. Setting R<sub>3D</sub> = 20kΩ and C<sub>3D</sub> = 0.22μF allows the LM4859 to produce a pronounced 3D effect with a minimal increase in output noise.

### EXPOSED-DAP MOUNTING CONSIDERATIONS

The LM4859's exposed-DAP (die attach paddle) package (SP) provides a low thermal resistance between the die and the PCB to which the part is mounted and soldered. This allows rapid heat transfer from the die to the surrounding PCB copper area heatsink, copper traces, ground plane, and finally, surrounding air. The result is a low voltage audio power amplifier that produces 1.6W dissipation in a 4Ω load at ≤ 1% THD+N and over 1.8W in a 3Ω load at 10% THD+N. This high power is achieved through careful consideration of necessary thermal design. Failing to optimize thermal design may compromise the LM4859's high power performance and activate unwanted, though necessary, thermal shutdown protection.

The SP package must have its DAP soldered to a copper pad on the PCB. The DAP's PCB copper pad is then, ideally, connected to a large plane of continuous unbroken copper. This plane forms a thermal mass, heat sink, and radiation area. Place the heat sink area on either outside plane in the case of a two-sided or multi-layer PCB. (The heat sink area can also be placed on an inner layer of a multi-layer board. The thermal resistance, however, will be higher.) Connect the DAP copper pad to the inner layer or backside copper heat sink area with 9 (3 X 3) (SP) vias. The via diameter should be 0.012in - 0.013in with a 1.27mm pitch. Ensure efficient thermal conductivity by plugging and tenting the vias with plating and solder mask, respectively.

Best thermal performance is achieved with the largest practical copper heat sink area. If the heatsink and amplifier share the same PCB layer, a nominal 2in<sup>2</sup> area is necessary for 5V operation with a 4Ω load. Heatsink areas not placed on the same PCB layer as the LM4859 should be 4in<sup>2</sup> for the same supply voltage and load resistance. The last two area recommendations apply for 25°C ambient temperature. Increase the area to compensate for ambient temperatures above 25°C. In all circumstances and under all conditions, the junction temperature must be held below 150°C to prevent activating the LM4859's thermal shutdown protection. An example PCB layout for the exposed-DAP SP package is

## Application Information (Continued)

shown in the **Demonstration Board Layout** section. Further detailed and specific information concerning PCB layout and fabrication and mounting an SP (LLP) is found in National Semiconductor's AN1187.

### PCB LAYOUT AND SUPPLY REGULATION CONSIDERATIONS FOR DRIVING 3Ω AND 4Ω LOADS

Power dissipated by a load is a function of the voltage swing across the load and the load's impedance. As load impedance decreases, load dissipation becomes increasingly dependent on the interconnect (PCB trace and wire) resistance between the amplifier output pins and the load's connections. Residual trace resistance causes a voltage drop, which results in power dissipated in the trace and not in the load as desired. For example, 0.1Ω trace resistance reduces the output power dissipated by a 4Ω load from 1.6W to 1.5W. The problem of decreased load dissipation is exacerbated as load impedance decreases. Therefore, to maintain the highest load dissipation and widest output voltage swing, PCB traces that connect the output pins to a load must be as wide as possible.

Poor power supply regulation adversely affects maximum output power. A poorly regulated supply's output voltage decreases with increasing load current. Reduced supply voltage causes decreased headroom, output signal clipping, and reduced output power. Even with tightly regulated supplies, trace resistance creates the same effects as poor supply regulation. Therefore, making the power supply traces as wide as possible helps maintain full output voltage swing.

### BRIDGE CONFIGURATION EXPLANATION

The LM4859 consists of two sets of bridged-tied amplifier pairs that drive the left loudspeaker (LLS) and the right loudspeaker (RLS). For this discussion, only the LLS bridged-tied amplifier pair will be referred to. The LM4859 drives a load, such as a speaker, connected between outputs, LLS+ and LLS-. In the LLS amplifier block, the output of the amplifier that drives LLS- serves as the input to the unity gain inverting amplifier that drives LLS+.

This results in both amplifiers producing signals identical in magnitude, but 180° out of phase. Taking advantage of this phase difference, a load is placed between LLS- and LLS+ and driven differentially (commonly referred to as 'bridge mode'). This results in a differential or BTL gain of:

$$A_{VD} = 2(R_f / R_i) = 2 \quad (2)$$

Both the feedback resistor,  $R_f$ , and the input resistor,  $R_i$ , are internally set.

Bridge mode amplifiers are different from single-ended amplifiers that drive loads connected between a single amplifier's output and ground. For a given supply voltage, bridge mode has a distinct advantage over the single-ended configuration: its differential output doubles the voltage swing across the load. Theoretically, this produces four times the output power when compared to a single-ended amplifier under the same conditions. This increase in attainable output power assumes that the amplifier is not current limited and that the output signal is not clipped.

Another advantage of the differential bridge output is no net DC voltage across the load. This is accomplished by biasing LLS- and LLS+ outputs at half-supply. This eliminates the

coupling capacitor that single supply, single-ended amplifiers require. Eliminating an output coupling capacitor in a typical single-ended configuration forces a single-supply amplifier's half-supply bias voltage across the load. This increases internal IC power dissipation and may permanently damage loads such as speakers.

### POWER DISSIPATION

Power dissipation is a major concern when designing a successful single-ended or bridged amplifier.

A direct consequence of the increased power delivered to the load by a bridge amplifier is higher internal power dissipation. The LM4859 has 2 sets of bridged-tied amplifier pairs driving LLS and RLS. The maximum internal power dissipation operating in the bridge mode is twice that of a single-ended amplifier. From Equation (3) and (4), assuming a 5V power supply and an 8Ω load, the maximum power dissipation for LLS and RLS is 634mW per channel.

$$P_{DMAX-LLS} = 4(V_{DD})^2 / (2\pi^2 R_L): \text{ Bridged} \quad (3)$$

$$P_{DMAX-RLS} = 4(V_{DD})^2 / (2\pi^2 R_L): \text{ Bridged} \quad (4)$$

The LM4859 also has a pair of single-ended amplifiers driving LHP and RHP. The maximum internal power dissipation for ROUT and LOUT is given by equation (5) and (6). From Equations (5) and (6), assuming a 5V power supply and a 32Ω load, the maximum power dissipation for LOUT and ROUT is 40mW per channel.

$$P_{DMAX-LHP} = (V_{DD})^2 / (2\pi^2 R_L): \text{ Single-ended} \quad (5)$$

$$P_{DMAX-RHP} = (V_{DD})^2 / (2\pi^2 R_L): \text{ Single-ended} \quad (6)$$

The maximum internal power dissipation of the LM4859 occurs during output modes 3, 8, and 13 when both loudspeaker and headphone amplifiers are simultaneously on; and is given by Equation (7).

$$P_{DMAX-TOTAL} = P_{DMAX-LLS} + P_{DMAX-RLS} + P_{DMAX-LHP} + P_{DMAX-RHP} \quad (7)$$

The maximum power dissipation point given by Equation (7) must not exceed the power dissipation given by Equation (8):

$$P_{DMAX}' = (T_{JMAX} - T_A) / \theta_{JA} \quad (8)$$

The LM4859's  $T_{JMAX} = 150^\circ\text{C}$ . In the SP package, the LM4859's  $\theta_{JA}$  is  $42^\circ\text{C/W}$ . At any given ambient temperature  $T_A$ , use Equation (8) to find the maximum internal power dissipation supported by the IC packaging. Rearranging Equation (8) and substituting  $P_{DMAX-TOTAL}$  for  $P_{DMAX}'$  results in Equation (9). This equation gives the maximum ambient temperature that still allows maximum stereo power dissipation without violating the LM4859's maximum junction temperature.

$$T_A = T_{JMAX} - P_{DMAX-TOTAL} \theta_{JA} \quad (9)$$



## Application Information (Continued)

For a typical application with a 5V power supply, stereo 8Ω loudspeaker load, and the stereo 32Ω headphone load, the maximum ambient temperature that allows maximum stereo power dissipation without exceeding the maximum junction temperature is approximately 93.4°C for the SP package.

$$T_{JMAX} = P_{DMAX-TOTAL} \theta_{JA} + T_A \quad (10)$$

Equation (10) gives the maximum junction temperature  $T_{JMAX}$ . If the result violates the LM4859's 150°C, reduce the maximum junction temperature by reducing the power supply voltage or increasing the load resistance. Further allowance should be made for increased ambient temperatures.

The above examples assume that a device is a surface mount part operating around the maximum power dissipation point. Since internal power dissipation is a function of output power, higher ambient temperatures are allowed as output power or duty cycle decreases. If the result of Equation (7) is greater than that of Equation (8), then decrease the supply voltage, increase the load impedance, or reduce the ambient temperature. If these measures are insufficient, a heat sink can be added to reduce  $\theta_{JA}$ . The heat sink can be created using additional copper area around the package, with connections to the ground pin(s), supply pin and amplifier output pins. External, solder attached SMT heatsinks such as the Thermalloy 7106D can also improve power dissipation. When adding a heat sink, the  $\theta_{JA}$  is the sum of  $\theta_{JC}$ ,  $\theta_{CS}$ , and  $\theta_{SA}$ . ( $\theta_{JC}$  is the junction-to-case thermal impedance,  $\theta_{CS}$  is the case-to-sink thermal impedance, and  $\theta_{SA}$  is the sink-to-ambient thermal impedance.) Refer to the Typical Performance Characteristics curves for power dissipation information at lower output power levels.

### POWER SUPPLY BYPASSING

As with any power amplifier, proper supply bypassing is critical for low noise performance and high power supply rejection. Applications that employ a 5V regulator typically use a 10μF in parallel with a 0.1μF filter capacitors to stabilize the regulator's output, reduce noise on the supply line, and improve the supply's transient response. However, their presence does not eliminate the need for a local 1.0μF tantalum bypass capacitance connected between the LM4859's supply pins and ground. Keep the length of leads and traces that connect capacitors between the LM4859's power supply pin and ground as short as possible.

### SELECTING EXTERNAL COMPONENTS

#### Input Capacitor Value Selection

Amplifying the lowest audio frequencies requires a high value input coupling capacitor ( $C_i$  in Figure 1). In many cases, however, the speakers used in portable systems, whether internal or external, have little ability to reproduce signals below 50Hz. Applications using speakers with this

limited frequency response reap little improvement; by using a large input capacitor.

The internal input resistor ( $R_i$ ) and the input capacitor ( $C_i$ ) produce a high pass filter cutoff frequency that is found using Equation (13).

$$f_c = 1 / (2\pi R_i C_i) \quad (11)$$

As an example when using a speaker with a low frequency limit of 50Hz and  $R_i = 20k\Omega$ ,  $C_i$  using Equation (13) is 0.19μF. The 0.22μF  $C_i$  shown in Figure 4 allows the LM4859 to drive high efficiency, full range speaker whose response extends below 40Hz.

#### Output Capacitor Value Selection

Amplifying the lowest audio frequencies also requires the use of a high value output coupling capacitor ( $C_o$  in Figure 1). A high value output capacitor can be expensive and may compromise space efficiency in portable design.

The speaker load ( $R_L$ ) and the output capacitor ( $C_o$ ) form a high pass filter with a low cutoff frequency determined using Equation (14).

$$f_c = 1 / (2\pi R_L C_o) \quad (12)$$

When using a typical headphone load of  $R_L = 32\Omega$  with a low frequency limit of 50Hz,  $C_o$  is 99μF.

The 100μF  $C_o$  shown in Figure 4 allows the LM4859 to drive a headphone whose frequency response extends below 50Hz.

#### Bypass Capacitor Value Selection

Besides minimizing the input capacitor size, careful consideration should be paid to value of  $C_B$ , the capacitor connected to the BYPASS pin. Since  $C_B$  determines how fast the LM4859 settles to quiescent operation, its value is critical when minimizing turn-on pops. The slower the LM4859's outputs ramp to their quiescent DC voltage (nominally  $V_{DD}/2$ ), the smaller the turn-on pop. Choosing  $C_B$  equal to 2.2μF along with a small value of  $C_i$  (in the range of 0.1μF to 0.39μF), produces a click-less and pop-less shutdown function. As discussed above, choosing  $C_i$  no larger than necessary for the desired bandwidth helps minimize clicks and pops.  $C_B$ 's value should be in the range of 5 times to 10 times the value of  $C_i$ . This ensures that output transients are eliminated when the LM4859 transitions in and out of shutdown mode. Connecting a 2.2μF capacitor,  $C_B$ , between the BYPASS pin and ground improves the internal bias voltage's stability and improves the amplifier's PSRR. The PSRR improvements increase as the bypass pin capacitor value increases. However, increasing the value of  $C_B$  will increase wake-up time. The selection of bypass capacitor value,  $C_B$ , depends on desired PSRR requirements, click and pop performance, wake-up time, system cost, and size constraints.

Application Information (Continued)

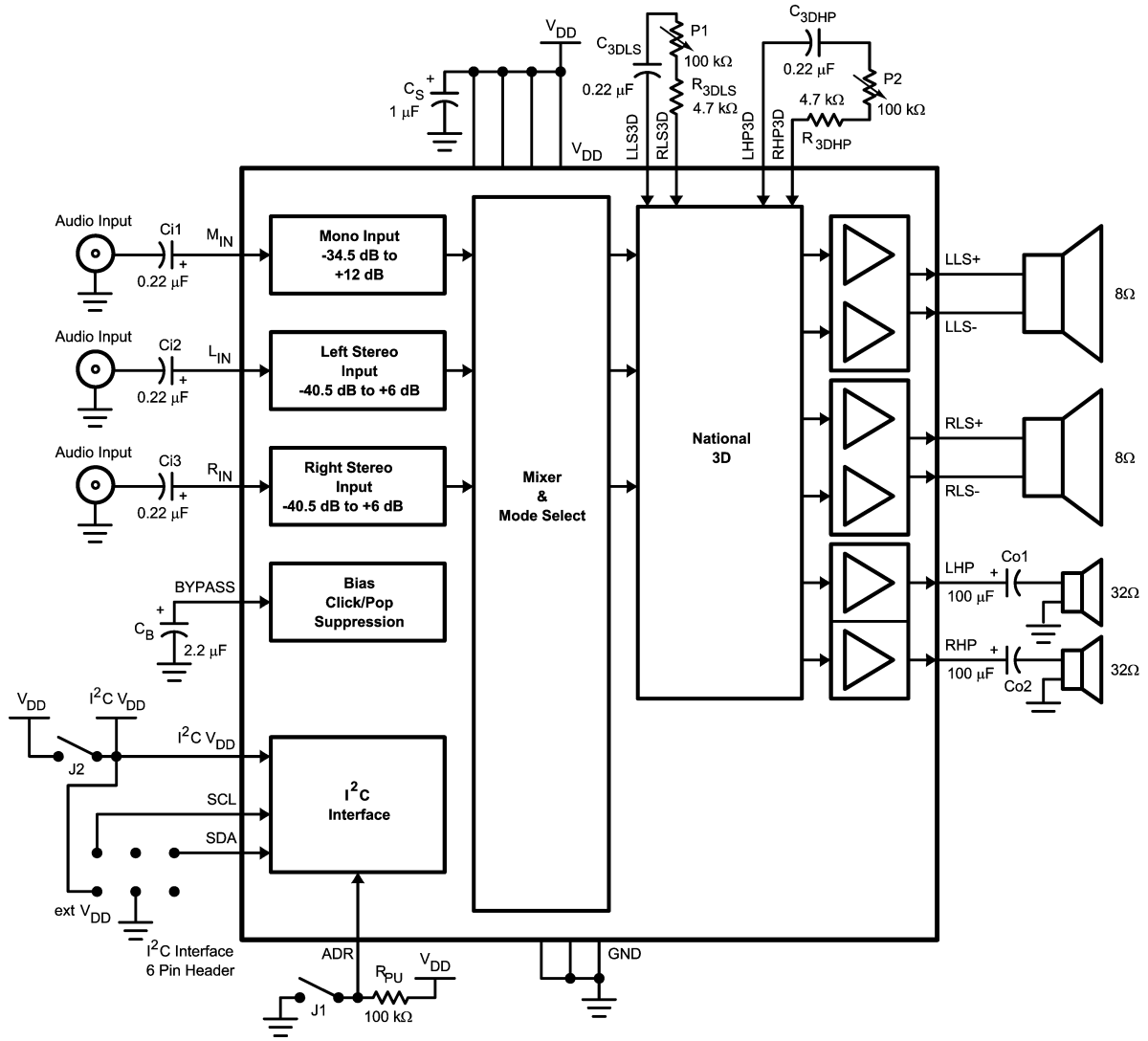

20106102

FIGURE 4. Reference Design Board Schematic

# Demonstration Board Layout

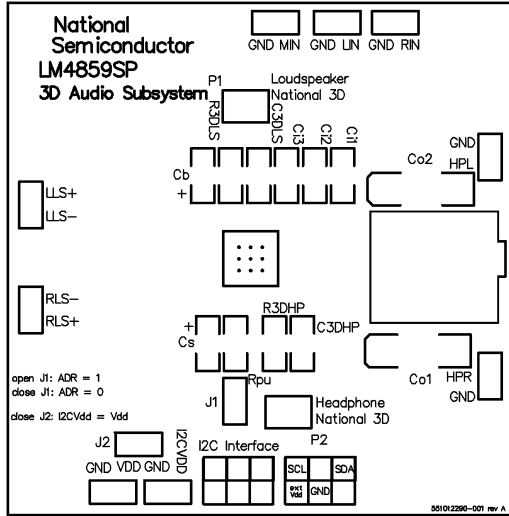

Recommended SP PCB Layout:  
Silkscreen Layer

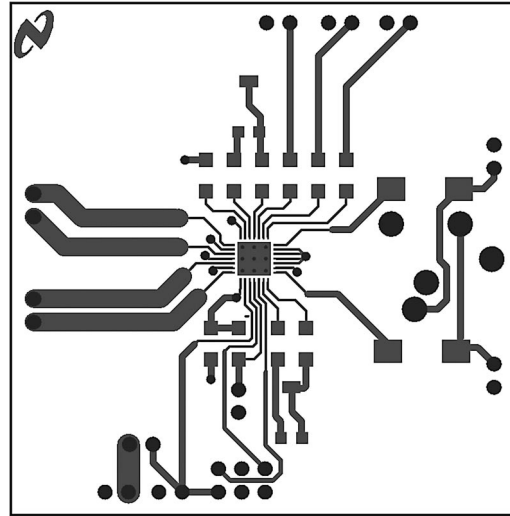

Recommended SP PCB Layout:  
Top Layer

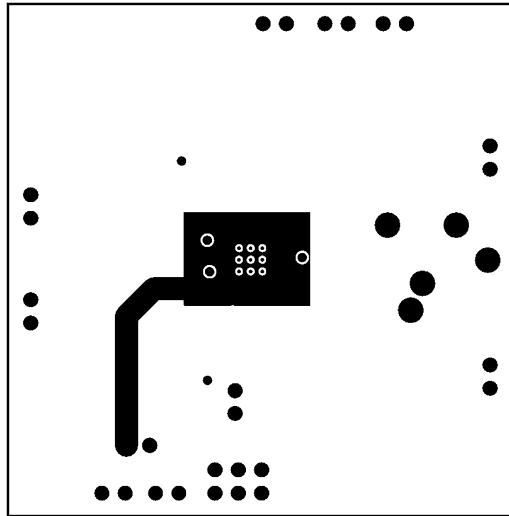

Recommended SP PCB Layout:  
Mid Layer

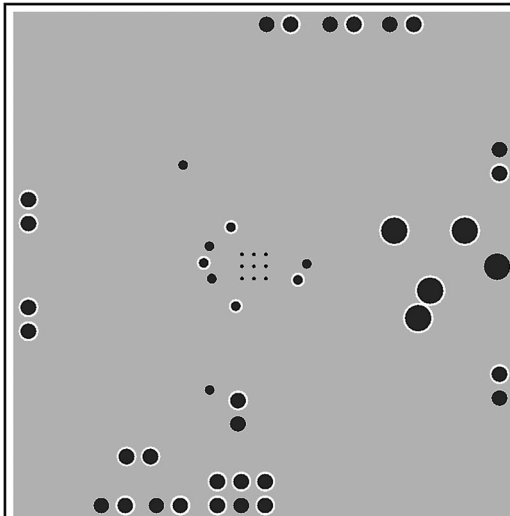

Recommended SP PCB Layout:  
Bottom Layer

**Physical Dimensions** inches (millimeters) unless otherwise noted

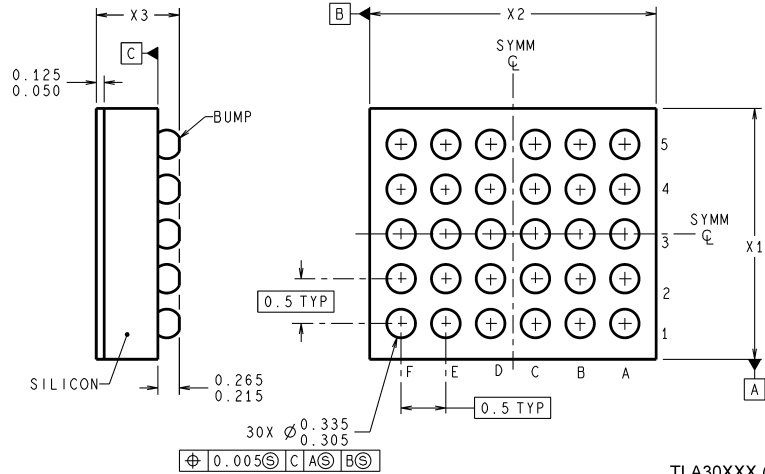
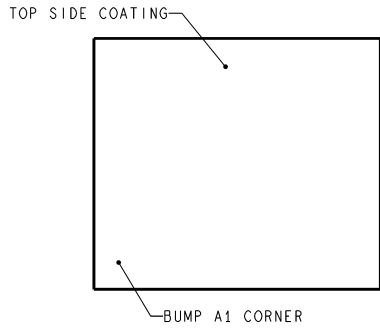
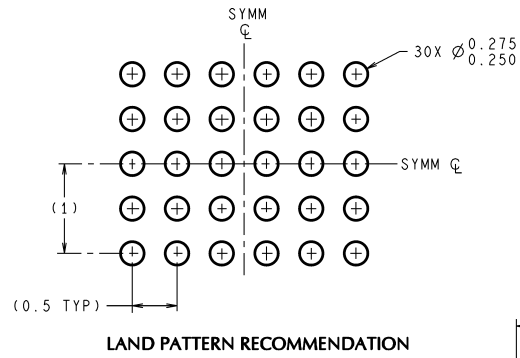

TLA30XXX (Rev C)

**30 Bump ITL Package**  
**Order Number LM4859ITL**  
**NS Package Number TLA30CZA**

**Physical Dimensions** inches (millimeters) unless otherwise noted (Continued)

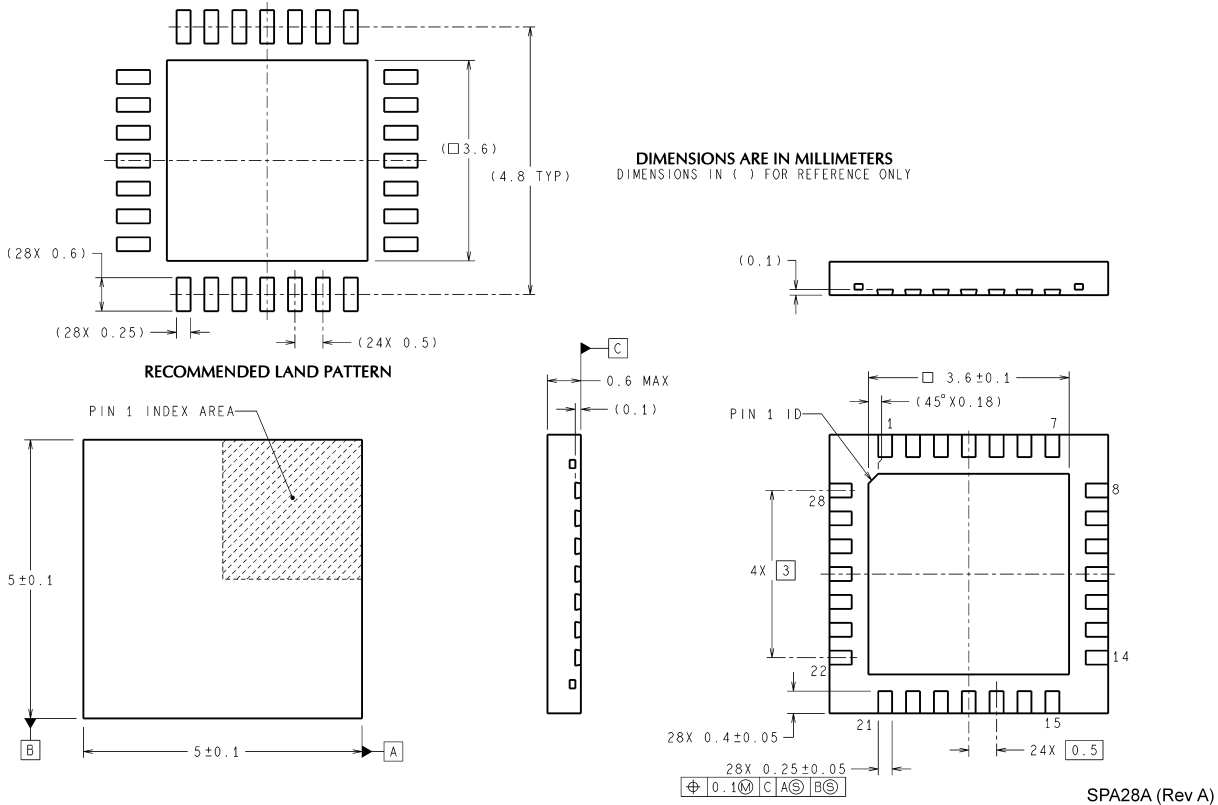

National does not assume any responsibility for use of any circuitry described, no circuit patent licenses are implied and National reserves the right at any time without notice to change said circuitry and specifications.

For the most current product information visit us at [www.national.com](http://www.national.com).

**LIFE SUPPORT POLICY**

NATIONAL'S PRODUCTS ARE NOT AUTHORIZED FOR USE AS CRITICAL COMPONENTS IN LIFE SUPPORT DEVICES OR SYSTEMS WITHOUT THE EXPRESS WRITTEN APPROVAL OF THE PRESIDENT AND GENERAL COUNSEL OF NATIONAL SEMICONDUCTOR CORPORATION. As used herein:

1. Life support devices or systems are devices or systems which, (a) are intended for surgical implant into the body, or (b) support or sustain life, and whose failure to perform when properly used in accordance with instructions for use provided in the labeling, can be reasonably expected to result in a significant injury to the user.
2. A critical component is any component of a life support device or system whose failure to perform can be reasonably expected to cause the failure of the life support device or system, or to affect its safety or effectiveness.

**BANNED SUBSTANCE COMPLIANCE**

National Semiconductor certifies that the products and packing materials meet the provisions of the Customer Products Stewardship Specification (CSP-9-111C2) and the Banned Substances and Materials of Interest Specification (CSP-9-111S2) and contain no "Banned Substances" as defined in CSP-9-111S2.



**National Semiconductor**  
Americas Customer  
Support Center  
Email: [new.feedback@nsc.com](mailto:new.feedback@nsc.com)  
Tel: 1-800-272-9959

**National Semiconductor**  
Europe Customer Support Center  
Fax: +49 (0) 180-530 85 86  
Email: [europe.support@nsc.com](mailto:europe.support@nsc.com)  
Deutsch Tel: +49 (0) 69 9508 6208  
English Tel: +44 (0) 870 24 0 2171  
Français Tel: +33 (0) 1 41 91 8790

**National Semiconductor**  
Asia Pacific Customer  
Support Center  
Email: [ap.support@nsc.com](mailto:ap.support@nsc.com)

**National Semiconductor**  
Japan Customer Support Center  
Fax: 81-3-5639-7507  
Email: [jpn.feedback@nsc.com](mailto:jpn.feedback@nsc.com)  
Tel: 81-3-5639-7560