

## LM4900 Boomer® Audio Power Amplifier Series 265mW at 3.3V Supply Audio Power Amplifier with Shutdown Mode

Check for Samples: [LM4900](#)

### FEATURES

- MSOP, LLP, and SOP Packaging
- No Output Coupling Capacitors, Bootstrap Capacitors, or Snubber Circuits are Necessary
- Thermal Shutdown Protection Circuitry
- Unity-gain Stable
- External Gain Configuration Capability
- Latest Generation "Click and Pop" Suppression Circuitry

### APPLICATIONS

- Cellular Phones
- PDA's
- Any Portable Audio Application

### KEY SPECIFICATIONS

- THD+N at 1kHz for 265mW Continuous Average Output Power into 8Ω,
  - $V_{DD} = 3.3V$ : 1.0% (max)
- THD+N at 1kHz for 675mW Continuous Average Output Power into 8Ω,
  - $V_{DD} = 5V$ : 1.0% (max)
- Shutdown Current: 0.1μA (typ)

### DESCRIPTION

The LM4900 is a bridged audio power amplifier capable of delivering 265mW of continuous average power into an 8Ω load with 1% THD+N from a 3.3V power supply.

Boomer® audio power amplifiers were designed specifically to provide high quality output power from a low supply voltage while requiring a minimal amount of external components. Since the LM4900 does not require output coupling capacitors, bootstrap capacitors or snubber networks, it is optimally suited for low-power portable applications.

The LM4900 features an externally controlled, low power consumption shutdown mode, and thermal shutdown protection.

The closed loop response of the unity-gain stable LM4900 can be configured by external gain-setting resistors.

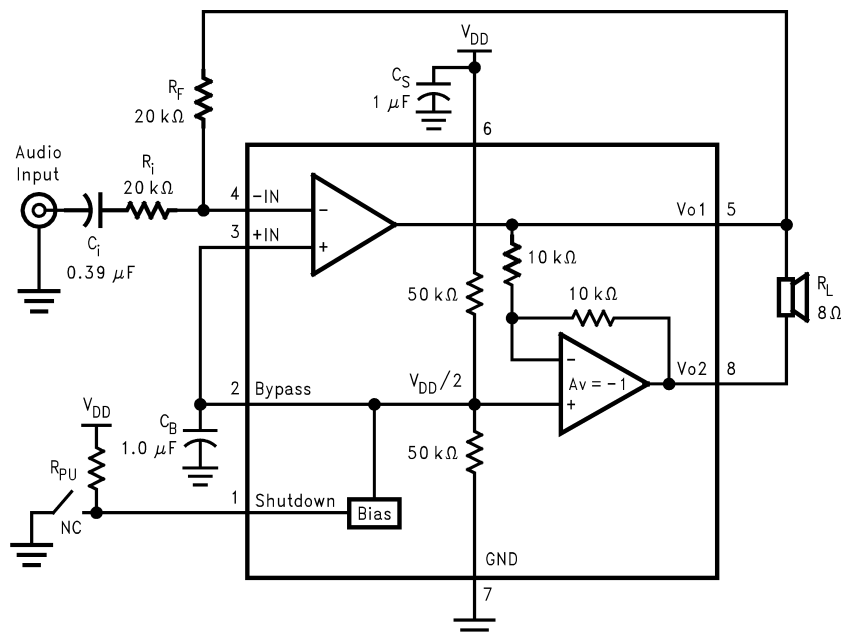


Please be aware that an important notice concerning availability, standard warranty, and use in critical applications of Texas Instruments semiconductor products and disclaimers thereto appears at the end of this data sheet.

Boomer is a registered trademark of Texas Instruments.

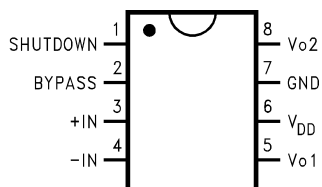
All other trademarks are the property of their respective owners.

**TYPICAL APPLICATION**

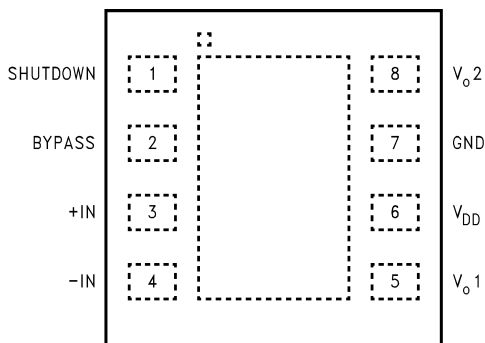


**Figure 1. Typical Audio Amplifier Application Circuit**

**CONNECTION DIAGRAM**



**VSSOP and SOIC Package (Top View)  
Package Number DGK, D**



**WSON Package (Top View)  
Package Number NGL**



These devices have limited built-in ESD protection. The leads should be shorted together or the device placed in conductive foam during storage or handling to prevent electrostatic damage to the MOS gates.

**ABSOLUTE MAXIMUM RATINGS<sup>(1)(2)</sup>**

Supply Voltage	6.0V
Storage Temperature	-65°C to +150°C
Input Voltage	-0.3V to $V_{DD} + 0.3V$
Power Dissipation <sup>(3)</sup>	Internally limited
ESD Susceptibility <sup>(4)</sup>	2000V
ESD Susceptibility <sup>(5)</sup>	200V
Junction Temperature	150°C
Soldering Information	
Small Outline Package	
Vapor Phase (60 sec.)	215°C
Infrared (15 sec.)	220°C
Thermal Resistance	
$\theta_{JC}$ (D)	35°C/W
$\theta_{JA}$ (D)	170°C/W
$\theta_{JC}$ (DGK)	56°C/W
$\theta_{JA}$ (DGK)	190°C/W
$\theta_{JA}$ (NGL)	67°C/W

- (1) Absolute Maximum Ratings indicate limits beyond which damage to the device may occur. Operating Ratings indicate conditions for which the device is functional, but do not ensure specific performance limits. Electrical Characteristics state DC and AC electrical specifications under particular test conditions which ensure specific performance limits. This assumes that the device is within the Operating Ratings. Specifications are not ensured for parameters where no limit is given, however, the typical value is a good indication of device performance.
- (2) If Military/Aerospace specified devices are required, please contact the Texas Instruments Sales Office/ Distributors for availability and specifications.
- (3) The maximum power dissipation must be derated at elevated temperatures and is dictated by  $T_{JMAX}$ ,  $\theta_{JA}$ , and the ambient temperature  $T_A$ . The maximum allowable power dissipation is  $P_{DMAX} = (T_{JMAX} - T_A)/\theta_{JA}$  or the number given in the Absolute Maximum Ratings, whichever is lower. For the LM4900,  $T_{JMAX} = 150^\circ\text{C}$ . The typical junction-to-ambient thermal resistance, when board mounted, is 190°C/W for package number DGK.
- (4) Human body model, 100pF discharged through a 1.5kΩ resistor.
- (5) Machine Model, 220pF–240pF discharged through all pins.

**OPERATING RATINGS**

Temperature Range	
$T_{MIN} \leq T_A \leq T_{MAX}$	$-40^\circ\text{C} \leq T_A \leq +85^\circ\text{C}$
Supply Voltage	$2.0V \leq V_{DD} \leq 5.5V$

**ELECTRICAL CHARACTERISTICS<sup>(1)(2)</sup>**

The following specifications apply for  $V_{DD} = 5V$ , for all available packages, unless otherwise specified. Limits apply for  $T_A = 25^\circ\text{C}$

Symbol	Parameter	Conditions	LM4900		Units (Limits)
			Typical <sup>(3)</sup>	Limit <sup>(4)</sup>	
$I_{DD}$	Quiescent Power Supply Current	$V_{IN} = 0V, I_O = 0A^{(5)}$	4	6.0	mA (max)
$I_{SD}$	Shutdown Current	$V_{PIN1} = V_{DD}$	0.1	5	μA (max)
$V_{OS}$	Output Offset Voltage	$V_{IN} = 0V$	5	50	mV (max)

- (1) All voltages are measured with respect to the ground pin, unless otherwise specified.
- (2) Absolute Maximum Ratings indicate limits beyond which damage to the device may occur. Operating Ratings indicate conditions for which the device is functional, but do not ensure specific performance limits. Electrical Characteristics state DC and AC electrical specifications under particular test conditions which ensure specific performance limits. This assumes that the device is within the Operating Ratings. Specifications are not ensured for parameters where no limit is given, however, the typical value is a good indication of device performance.
- (3) Typicals are measured at 25°C and represent the parametric normal.
- (4) Datasheet min/max specification limits are specified by design, test, or statistical analysis.
- (5) The quiescent power supply current depends on the offset voltage when a practical load is connected to the amplifier.

## ELECTRICAL CHARACTERISTICS<sup>(1)(2)</sup> (continued)

The following specifications apply for  $V_{DD} = 5V$ , for all available packages, unless otherwise specified. Limits apply for  $T_A = 25^\circ C$

Symbol	Parameter	Conditions	LM4900		Units (Limits)
			Typical <sup>(3)</sup>	Limit <sup>(4)</sup>	
$P_O$	Output Power	THD = 1% (max); $f = 1kHz$ ; $R_L = 8\Omega$ ;	675	300	mW (min)
THD+N	Total Harmonic Distortion+Noise	$P_O = 400\text{ mWrms}$ ; $A_{VD} = 2$ ; $R_L = 8\Omega$ ; $20Hz \leq f \leq 20kHz$ , BW < 80kHz	0.4		%
PSRR	Power Supply Rejection Ratio	$V_{RIPPLE} = 200mV$ sine p-p	$f = 217Hz$ <sup>(6)</sup>	70	dB
			$f = 1KHz$ <sup>(6)</sup>	67	
			$f = 217Hz$ <sup>(7)</sup>	55	
			$f = 1KHz$ <sup>(7)</sup>	55	

(6) Unterminated input.

(7)  $10\Omega$  terminated input.

## ELECTRICAL CHARACTERISTICS<sup>(1)(2)</sup>

The following specifications apply for  $V_{DD} = 3.3V$ , for all available packages, unless otherwise specified. Limits apply for  $T_A = 25^\circ C$

Symbol	Parameter	Conditions	LM4900		Units (Limits)
			Typical <sup>(3)</sup>	Limit <sup>(4)</sup>	
$I_{DD}$	Quiescent Power Supply Current	$V_{IN} = 0V$ , $I_O = 0A$ <sup>(5)</sup>	3	5	mA (max)
$I_{SD}$	Shutdown Current	$V_{PIN1} = V_{DD}$	0.1	3	$\mu A$ (max)
$V_{OS}$	Output Offset Voltage	$V_{IN} = 0V$	5	50	mV (max)
$P_O$	Output Power	THD = 1% (max); $f = 1kHz$ ; $R_L = 8\Omega$ ;	265		mW (min)
THD+N	Total Harmonic Distortion+Noise	$P_O = 250\text{ mWrms}$ ; $A_{VD} = 2$ ; $R_L = 8\Omega$ ; $20Hz \leq f \leq 20kHz$ , BW < 80kHz	0.4		%
PSRR	Power Supply Rejection Ratio	$V_{RIPPLE} = 200mV$ sine p-p	$f = 217Hz$ <sup>(6)</sup>	73	dB
			$f = 1KHz$ <sup>(6)</sup>	70	
			$f = 217Hz$ <sup>(7)</sup>	60	
			$f = 1KHz$ <sup>(7)</sup>	68	

(1) All voltages are measured with respect to the ground pin, unless otherwise specified.

(2) Absolute Maximum Ratings indicate limits beyond which damage to the device may occur. Operating Ratings indicate conditions for which the device is functional, but do not ensure specific performance limits. Electrical Characteristics state DC and AC electrical specifications under particular test conditions which ensure specific performance limits. This assumes that the device is within the Operating Ratings. Specifications are not ensured for parameters where no limit is given, however, the typical value is a good indication of device performance.

(3) Typicals are measured at  $25^\circ C$  and represent the parametric normal.

(4) Datasheet min/max specification limits are specified by design, test, or statistical analysis.

(5) The quiescent power supply current depends on the offset voltage when a practical load is connected to the amplifier.

(6) Unterminated input.

(7)  $10\Omega$  terminated input.

## ELECTRICAL CHARACTERISTICS<sup>(1)(2)</sup>

The following specifications apply for  $V_{DD} = 2.6V$ , for all available packages, unless otherwise specified. Limits apply for  $T_A = 25^\circ C$

Symbol	Parameter	Conditions	LM4900		Units (Limits)
			Typical <sup>(3)</sup>	Limit <sup>(4)</sup>	
$I_{DD}$	Quiescent Power Supply Current	$V_{IN} = 0V, I_O = 0A$ <sup>(5)</sup>	2.6	4	mA (max)
$I_{SD}$	Shutdown Current	$V_{PIN1} = V_{DD}$	0.1	2.0	$\mu A$ (max)
$V_{OS}$	Output Offset Voltage	$V_{IN} = 0V$	5		mV
$P_O$	Output Power	THD = 1% (max); $f = 1kHz$ ; $R_L = 8\Omega$	130		mW
THD+N	Total Harmonic Distortion+Noise	$P_O = 100$ mWrms; $A_{VD} = 2$ ; $R_L = 8\Omega$ ; $20Hz \leq f \leq 20kHz$ , BW < 80kHz	0.4		%
PSRR	Power Supply Rejection Ratio	$V_{RIPPLE} = 200mV$ sine p-p	$f = 217Hz$ <sup>(6)</sup>	58	dB
			$f = 1KHz$ <sup>(6)</sup>	63	

- (1) All voltages are measured with respect to the ground pin, unless otherwise specified.
- (2) Absolute Maximum Ratings indicate limits beyond which damage to the device may occur. Operating Ratings indicate conditions for which the device is functional, but do not ensure specific performance limits. Electrical Characteristics state DC and AC electrical specifications under particular test conditions which ensure specific performance limits. This assumes that the device is within the Operating Ratings. Specifications are not ensured for parameters where no limit is given, however, the typical value is a good indication of device performance.
- (3) Typicals are measured at  $25^\circ C$  and represent the parametric normal.
- (4) Datasheet min/max specification limits are specified by design, test, or statistical analysis.
- (5) The quiescent power supply current depends on the offset voltage when a practical load is connected to the amplifier.
- (6)  $10\Omega$  terminated input.

## EXTERNAL COMPONENTS DESCRIPTION

(Figure 1)

Components	Functional Description
1. $R_i$	Inverting input resistance which sets the closed-loop gain in conjunction with $R_F$ . This resistor also forms a high pass filter with $C_i$ at $f_c = 1/(2\pi R_i C_i)$ .
2. $C_i$	Input coupling capacitor which blocks the DC voltage at the amplifier's input terminals. Also creates a highpass filter with $R_i$ at $f_c = 1/(2\pi R_i C_i)$ . Refer to the section, <a href="#">PROPER SELECTION OF EXTERNAL COMPONENTS</a> for an explanation of how to determine the value of $C_i$ .
3. $R_F$	Feedback resistance which sets the closed-loop gain in conjunction with $R_i$ .
4. $C_S$	Supply bypass capacitor which provides power supply filtering. Refer to the <a href="#">POWER SUPPLY BYPASSING</a> section for information concerning proper placement and selection of the supply bypass capacitor.
5. $C_B$	Bypass pin capacitor which provides half-supply filtering. Refer to the <a href="#">PROPER SELECTION OF EXTERNAL COMPONENTS</a> for information concerning proper placement and selection of $C_B$ .

TYPICAL PERFORMANCE CHARACTERISTICS

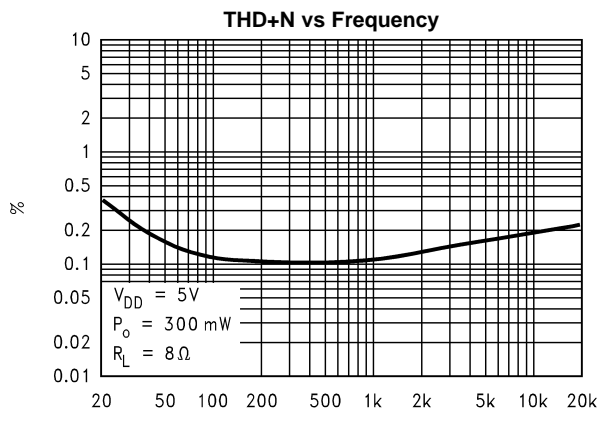


Figure 2.

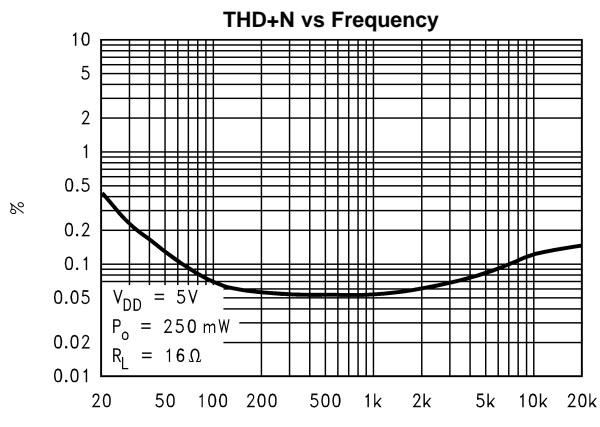


Figure 3.

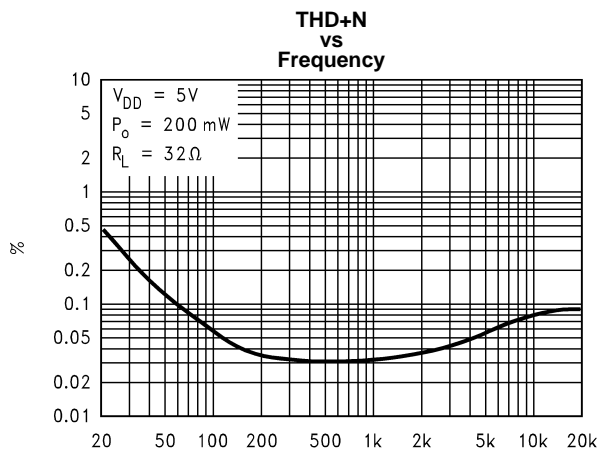


Figure 4.

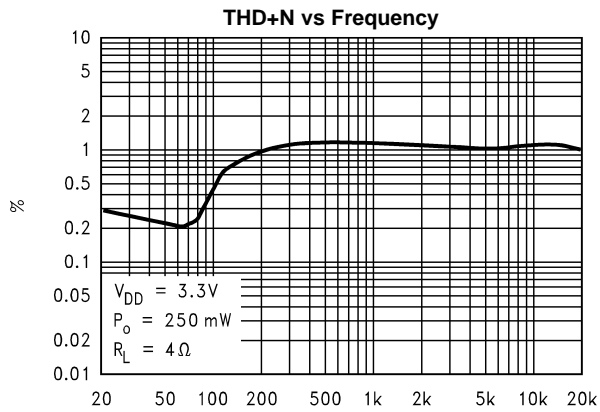


Figure 5.

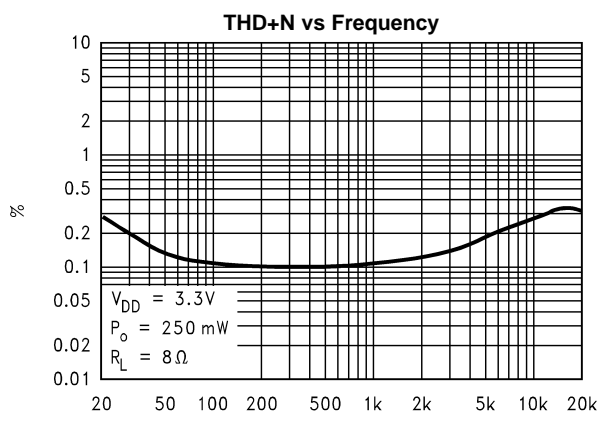


Figure 6.

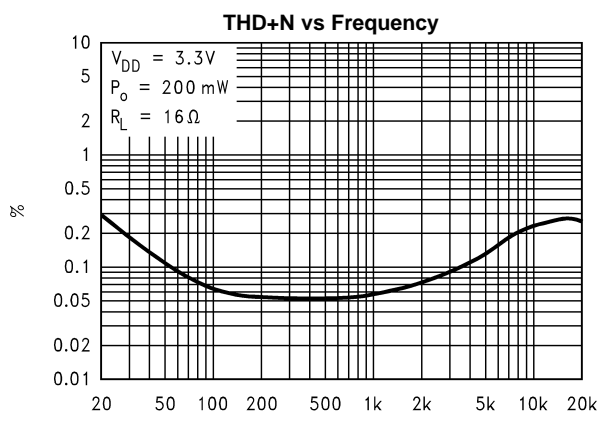


Figure 7.

**TYPICAL PERFORMANCE CHARACTERISTICS (continued)**

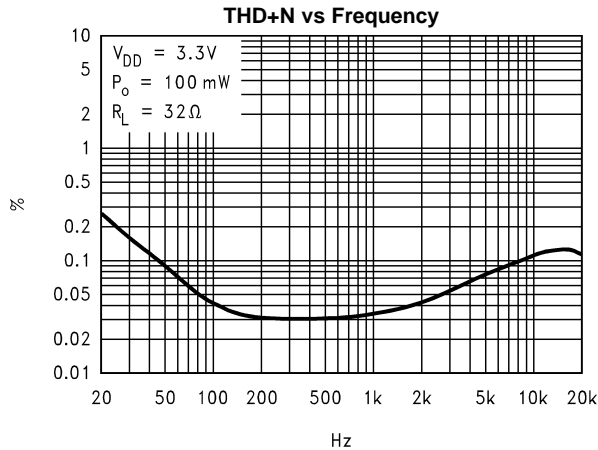


Figure 8.

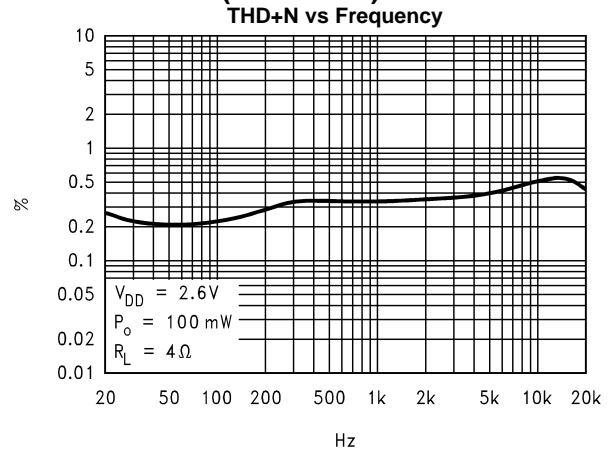


Figure 9.

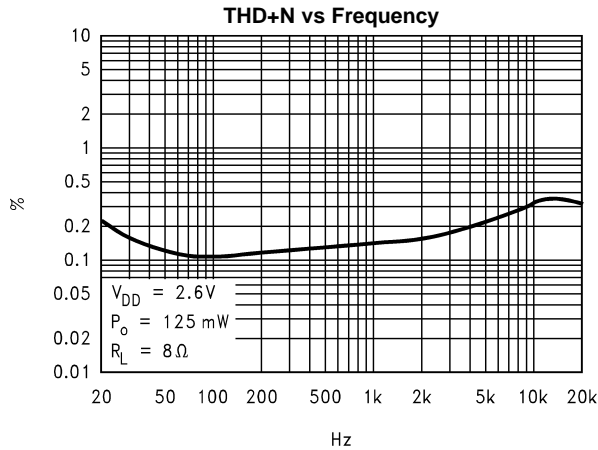


Figure 10.

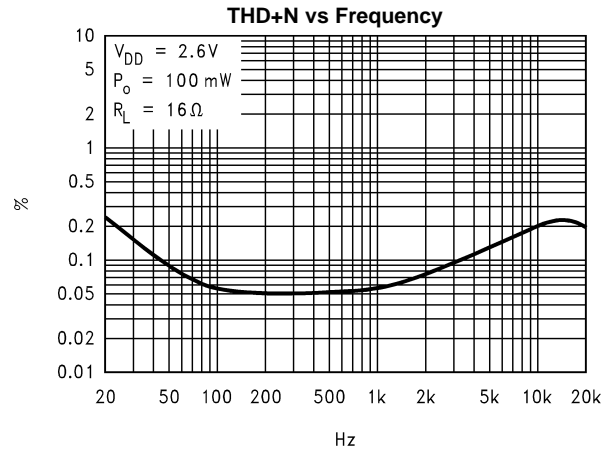


Figure 11.

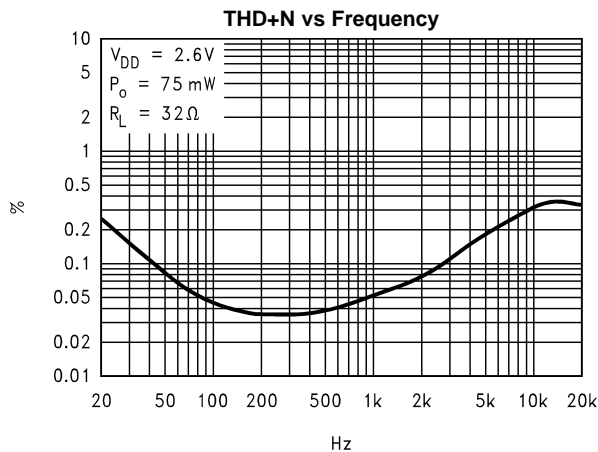


Figure 12.

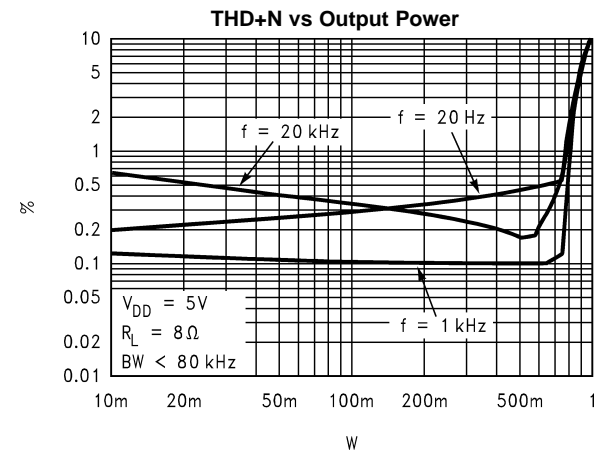


Figure 13.

**TYPICAL PERFORMANCE CHARACTERISTICS (continued)**

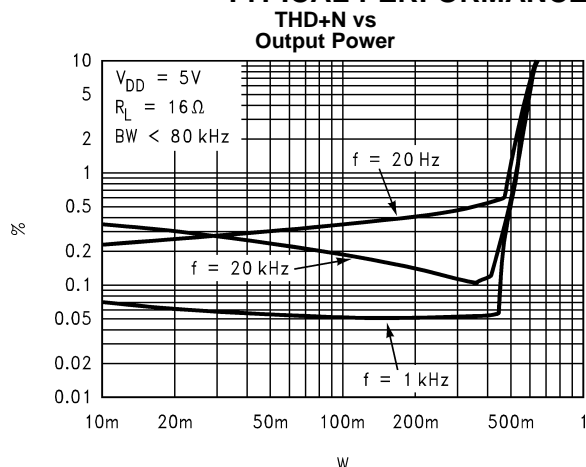


Figure 14.

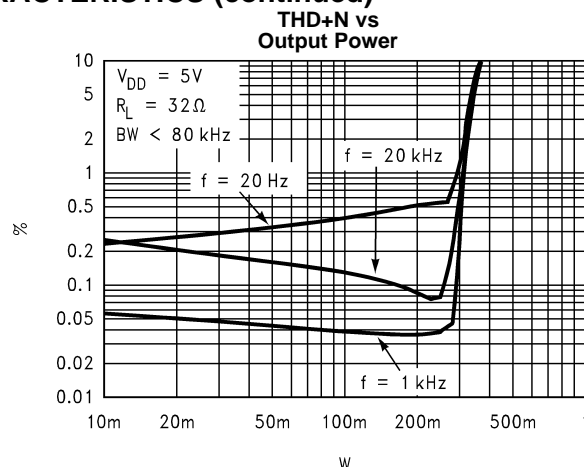


Figure 15.

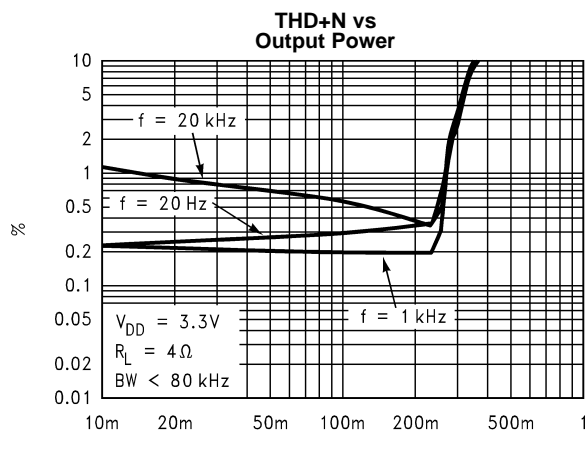


Figure 16.

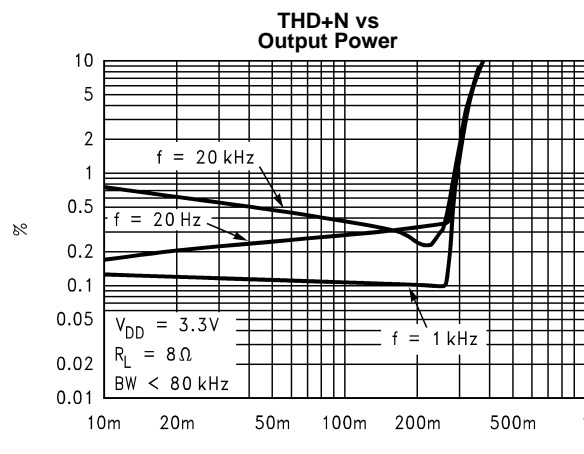


Figure 17.

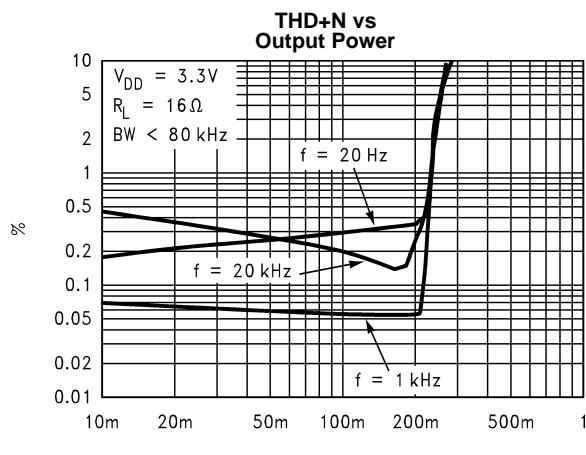


Figure 18.

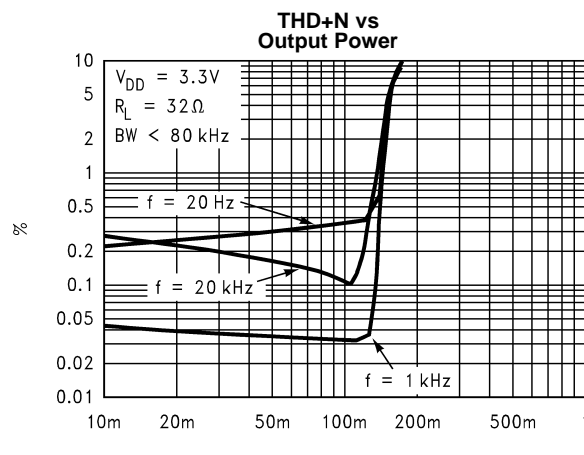


Figure 19.



**TYPICAL PERFORMANCE CHARACTERISTICS (continued)**

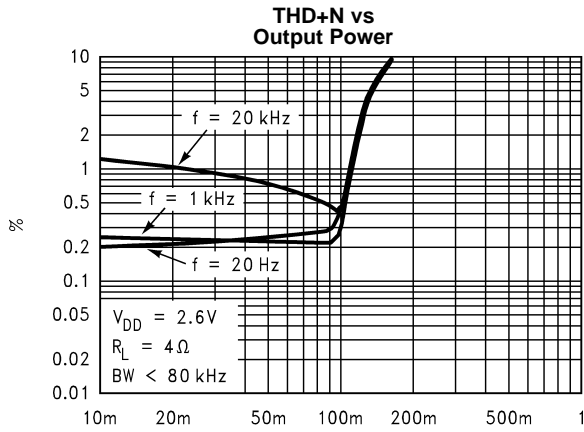


Figure 20.

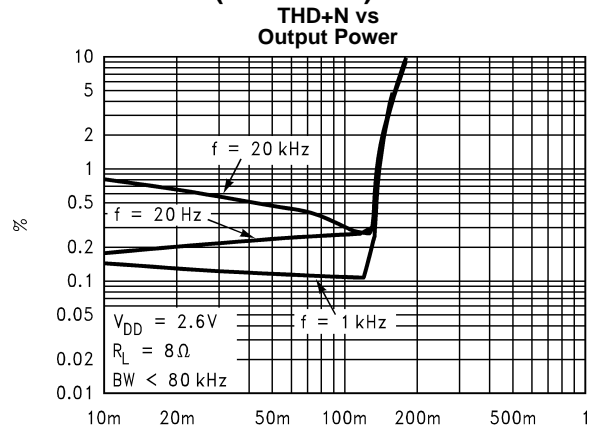


Figure 21.

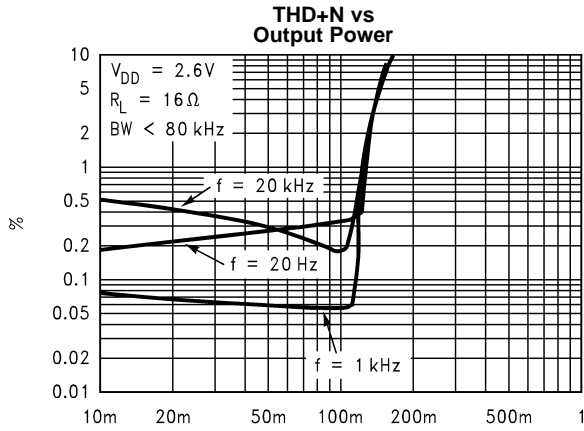


Figure 22.

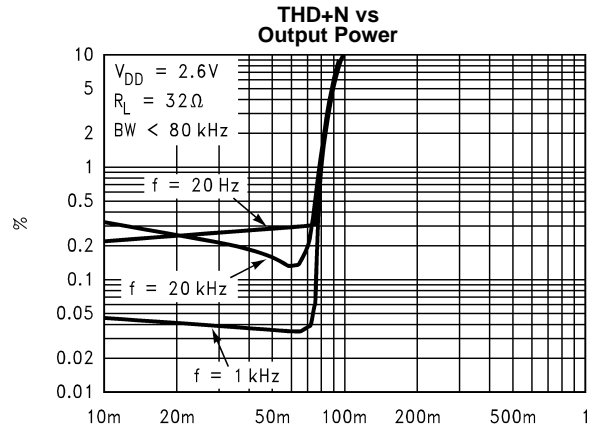


Figure 23.

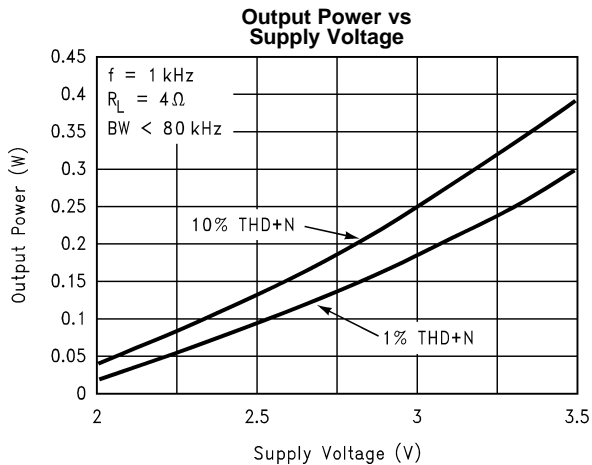


Figure 24.

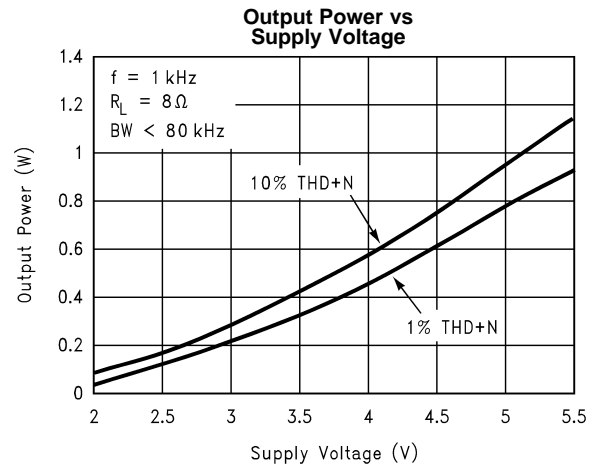


Figure 25.

**TYPICAL PERFORMANCE CHARACTERISTICS (continued)**

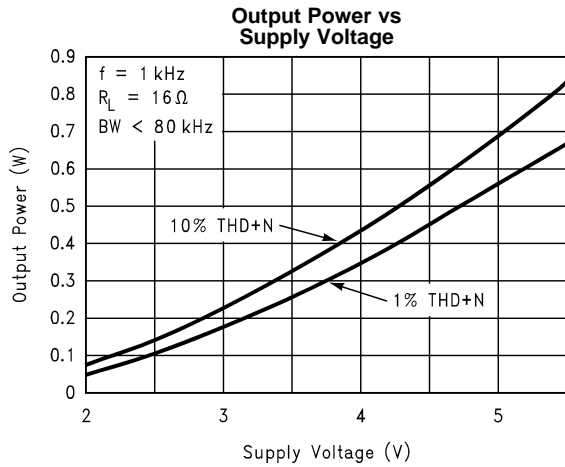


Figure 26.

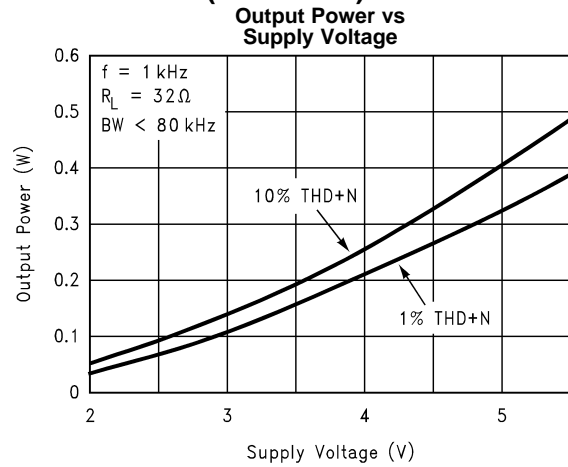


Figure 27.

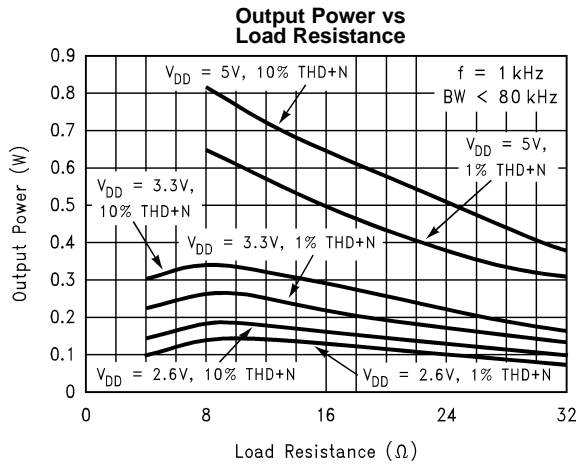


Figure 28.

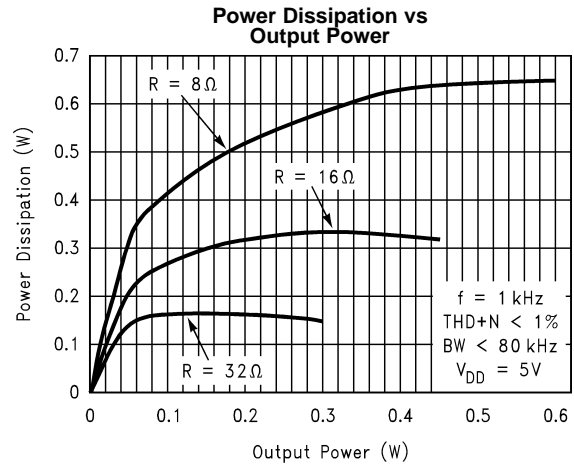


Figure 29.

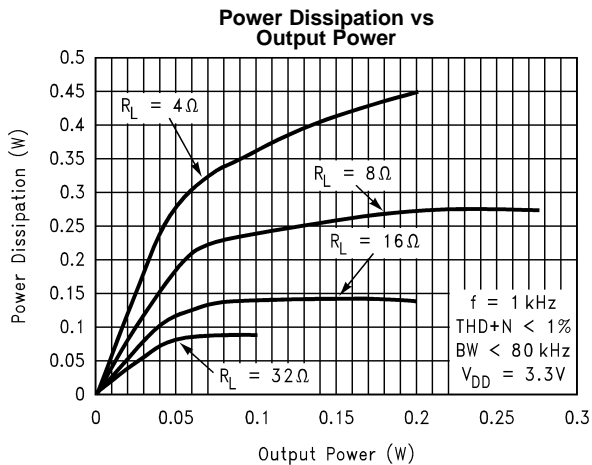


Figure 30.

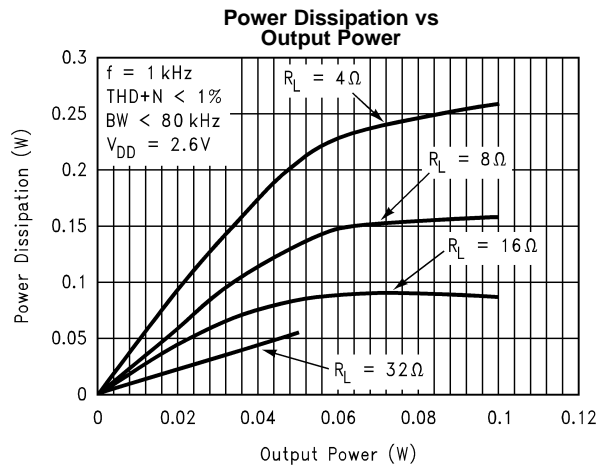


Figure 31.

**TYPICAL PERFORMANCE CHARACTERISTICS (continued)**

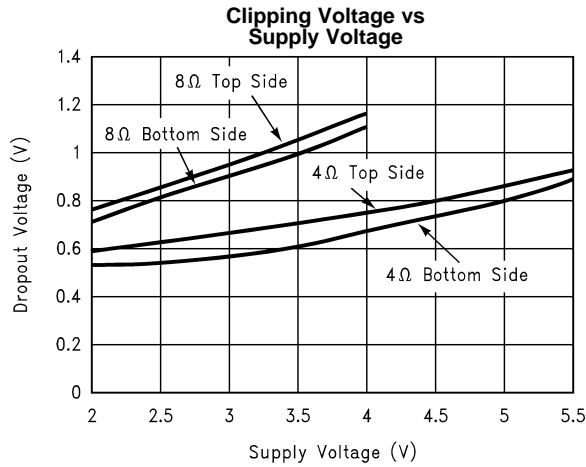


Figure 32.

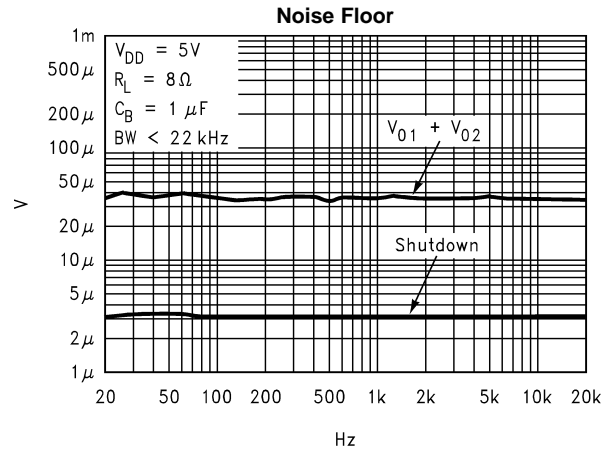


Figure 33.

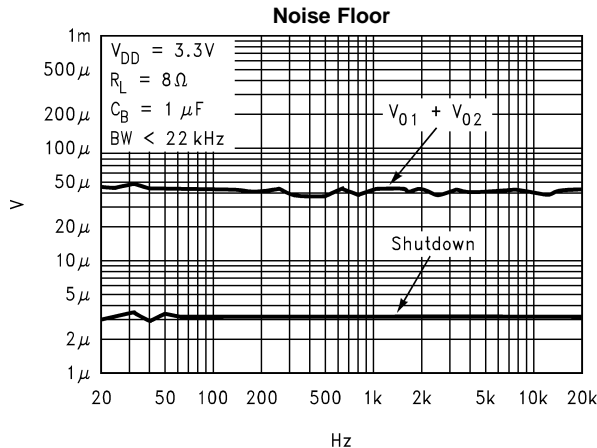


Figure 34.

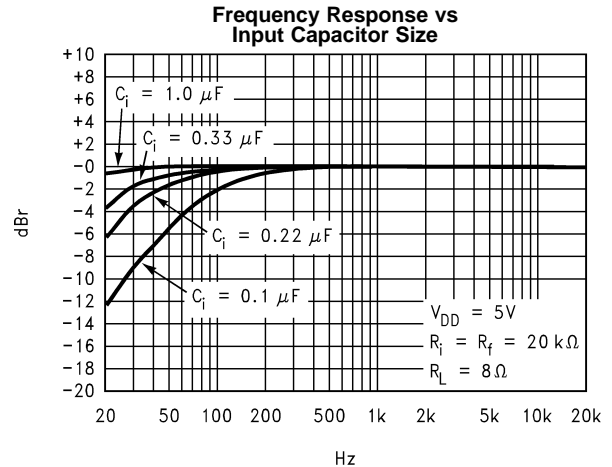


Figure 35.

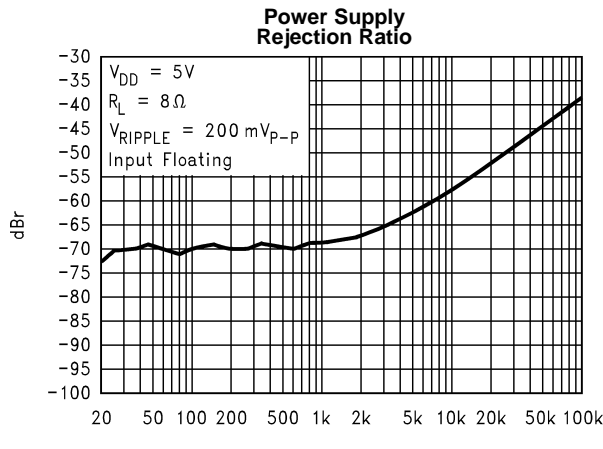


Figure 36.

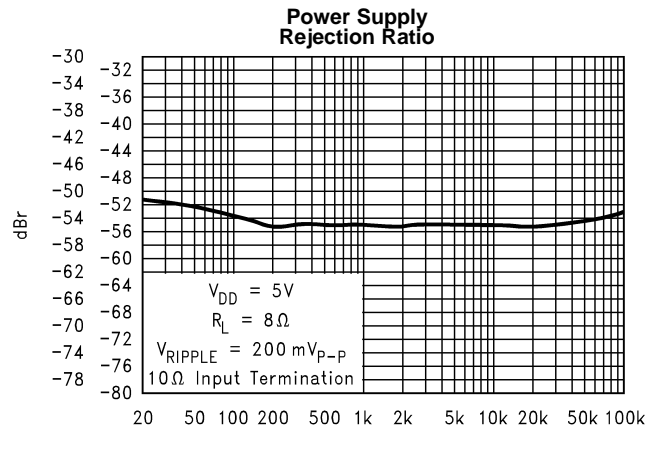


Figure 37.

**TYPICAL PERFORMANCE CHARACTERISTICS (continued)**

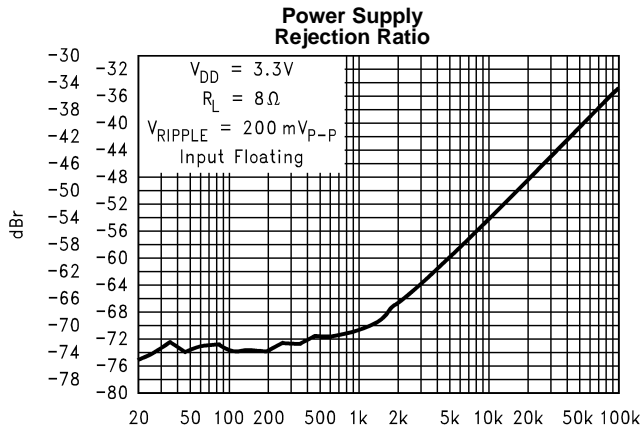


Figure 38.

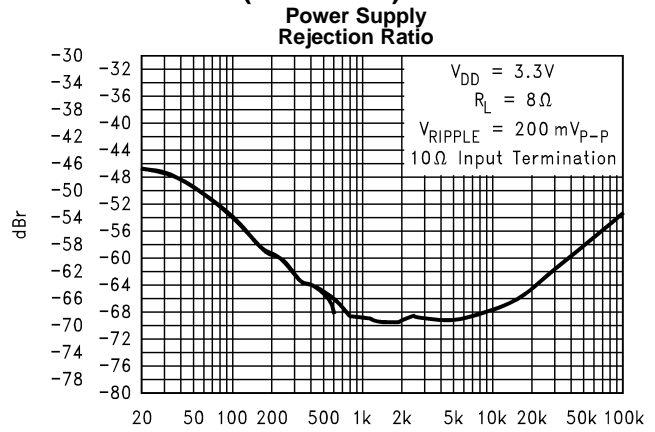


Figure 39.

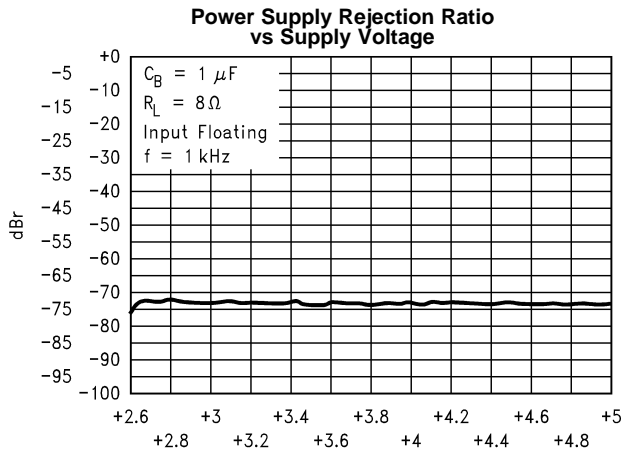


Figure 40.

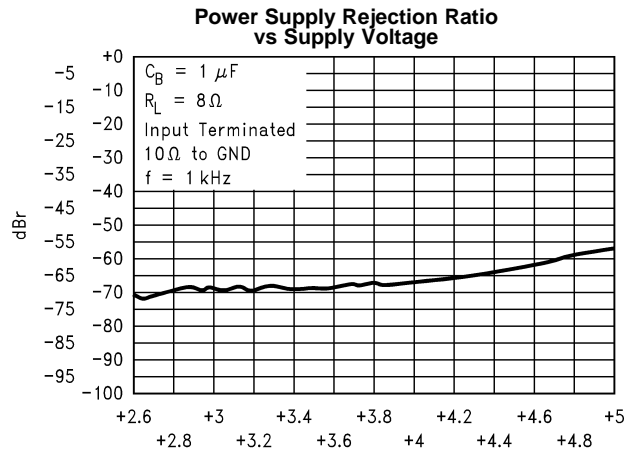


Figure 41.

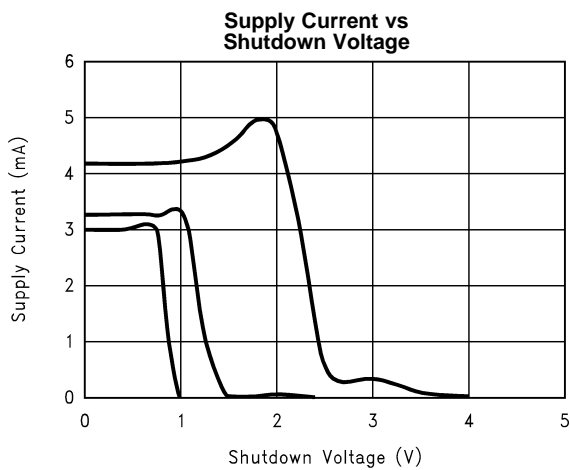


Figure 42.

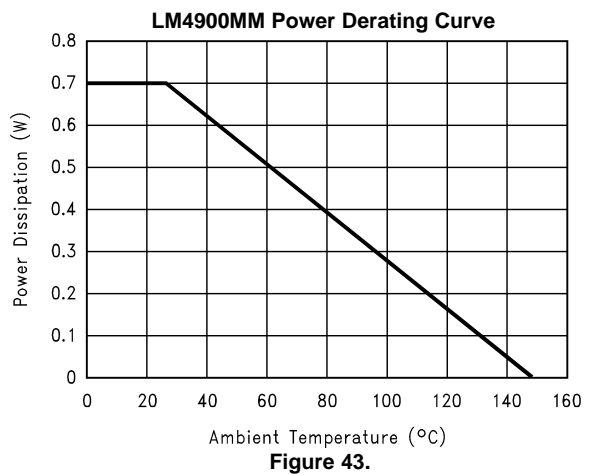


Figure 43.

**TYPICAL PERFORMANCE CHARACTERISTICS (continued)**

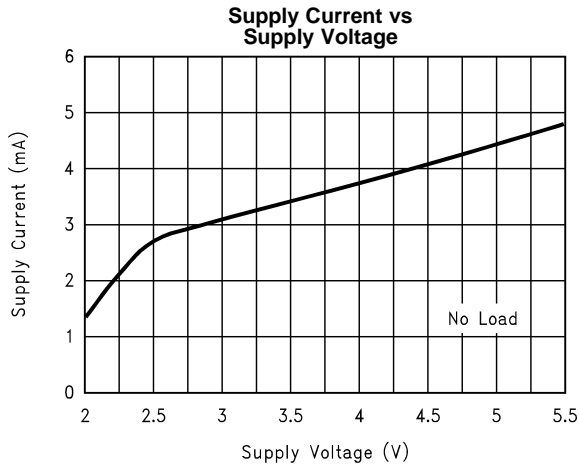
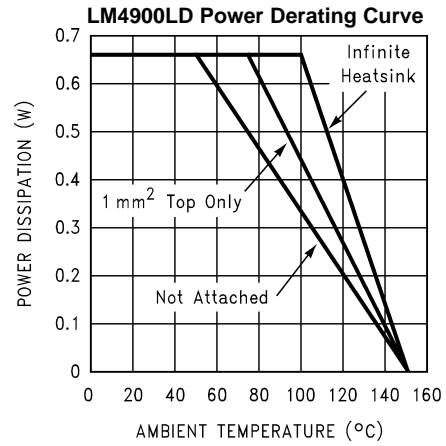


Figure 44.



This curve shows the LM4900LD's thermal dissipation ability at different ambient temperatures given the exposed-DAP of the part is soldered to a plane of 1oz. Cu with an area given in the label of each curve.

Figure 45.

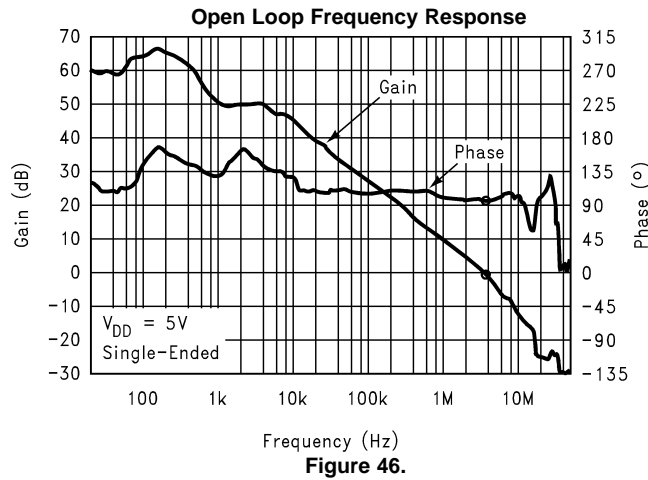


Figure 46.

## APPLICATION INFORMATION

### EXPOSED-DAP PACKAGE PCB MOUNTING CONSIDERATION

The LM4900's exposed-DAP (die-attach paddle) package (NGL) provides a low thermal resistance between the die and the PCB to which the part is mounted and soldered. This allows rapid heat from the die to the surrounding PCB copper traces, ground plane, and surrounding air. This allows the NGL to operate at higher output power levels in higher ambient temperatures than the DGK, D package. Failing to optimize thermal design may compromise the high power performance and activate unwanted, though necessary, thermal shutdown protection.

The NGL package must have its DAP soldered to a copper pad on the PCB. The DAP's PCB copper pad is connected to a large plane of continuous unbroken copper. This plane forms a thermal mass, heat sink, and radiation area. Place the heat sink area on either outside plane in the case of a two-sided PCB, or on an inner layer of a board with more than two layers. Connect the DAP copper pad to the inner layer or backside copper heat sink area with 2 vias. The via diameter should be 0.012in - 0.013in with a 1.27mm pitch. Ensure efficient thermal conductivity by plating through the vias.

Best thermal performance is achieved with the largest practical heat sink area. The power derating curve in the [TYPICAL PERFORMANCE CHARACTERISTICS](#) shows the maximum power dissipation versus temperature for several different areas of heat sink area. Placing the majority of the heat sink area on another plane is preferred as heat is best dissipated through the bottom of the chip. Further detailed and specific information concerning PCB layout, fabrication, and mounting an NGL (WSON) package is available from Texas Instrument's Package Engineering Group under application note AN1187.

### BRIDGE CONFIGURATION EXPLANATION

As shown in [Figure 1](#), the LM4900 has two operational amplifiers internally, allowing for a few different amplifier configurations. The first amplifier's gain is externally configurable, while the second amplifier is internally fixed in a unity-gain, inverting configuration. The closed-loop gain of the first amplifier is set by selecting the ratio of  $R_F$  to  $R_i$  while the second amplifier's gain is fixed by the two internal 10 k $\Omega$  resistors. [Figure 1](#) shows that the output of amplifier one serves as the input to amplifier two which results in both amplifiers producing signals identical in magnitude, but out of phase 180°. Consequently, the differential gain for the IC is

$$A_{VD} = 2 * (R_F / R_i)$$

By driving the load differentially through outputs  $V_{o1}$  and  $V_{o2}$ , an amplifier configuration commonly referred to as "bridged mode" is established. Bridged mode operation is different from the classical single-ended amplifier configuration where one side of its load is connected to ground.

A bridge amplifier design has a few distinct advantages over the single-ended configuration, as it provides differential drive to the load, thus doubling output swing for a specified supply voltage. Four times the output power is possible as compared to a single-ended amplifier under the same conditions. This increase in attainable output power assumes that the amplifier is not current limited or clipped. In order to choose an amplifier's closed-loop gain without causing excessive clipping, please refer to the [AUDIO POWER AMPLIFIER DESIGN](#) section.

A bridge configuration, such as the one used in LM4900, also creates a second advantage over single-ended amplifiers. Since the differential outputs,  $V_{o1}$  and  $V_{o2}$ , are biased at half-supply, no net DC voltage exists across the load. This eliminates the need for an output coupling capacitor which is required in a single supply, single-ended amplifier configuration. If an output coupling capacitor is not used in a single-ended configuration, the half-supply bias across the load would result in both increased internal IC power dissipation as well as permanent loudspeaker damage.

### POWER DISSIPATION

Power dissipation is a major concern when designing a successful amplifier, whether the amplifier is bridged or single-ended. [Equation 1](#) states the maximum power dissipation point for a bridge amplifier operating at a given supply voltage and driving a specified output load.

$$P_{D_{MAX}} = (V_{DD})^2 / (2\pi^2 R_L) \quad \text{Single-Ended} \quad (1)$$

However, a direct consequence of the increased power delivered to the load by a bridge amplifier is an increase in internal power dissipation point for a bridge amplifier operating at the same conditions.

$$P_{D_{MAX}} = 4(V_{DD})^2 / (2\pi^2 R_L) \quad \text{Bridge Mode} \quad (2)$$

Since the LM4900 has two operational amplifiers in one package, the maximum internal power dissipation is 4 times that of a single-ended amplifier. Even with this substantial increase in power dissipation, the LM4900 does not require heatsinking. From [Equation 1](#), assuming a 5V power supply and an 8Ω load, the maximum power dissipation point is 625 mW. The maximum power dissipation point obtained from [Equation 2](#) must not be greater than the power dissipation that results from [Equation 3](#):

$$P_{\text{DMAX}} = (T_{\text{JMAX}} - T_{\text{A}}) / \theta_{\text{JA}} \quad (3)$$

For package DGK,  $\theta_{\text{JA}} = 190^{\circ}\text{C/W}$ .  $T_{\text{JMAX}} = 150^{\circ}\text{C}$  for the LM4900. Depending on the ambient temperature,  $T_{\text{A}}$ , of the system surroundings, [Equation 3](#) can be used to find the maximum internal power dissipation supported by the IC packaging. If the result of [Equation 2](#) is greater than that of [Equation 3](#), then either the supply voltage must be decreased, the load impedance increased, the ambient temperature reduced, or the  $\theta_{\text{JA}}$  reduced with heatsinking. In many cases larger traces near the output,  $V_{\text{DD}}$ , and Gnd pins can be used to lower the  $\theta_{\text{JA}}$ . The larger areas of copper provide a form of heatsinking allowing a higher power dissipation. For the typical application of a 5V power supply, with an 8Ω load, the maximum ambient temperature possible without violating the maximum junction temperature is approximately 30°C provided that device operation is around the maximum power dissipation point. Internal power dissipation is a function of output power. If typical operation is not around the maximum power dissipation point, the ambient temperature can be increased. Refer to the [TYPICAL PERFORMANCE CHARACTERISTICS](#) curves for power dissipation information for lower output powers.

## POWER SUPPLY BYPASSING

As with any power amplifier, proper supply bypassing is critical for low noise performance and high power supply rejection. The capacitor location on both the bypass and power supply pins should be as close to the device as possible. The effect of a larger half supply bypass capacitor is improved PSRR due to increased half-supply stability. Typical applications employ a 5V regulator with 10μF and a 0.1μF bypass capacitors which aid in supply stability, but do not eliminate the need for bypassing the supply nodes of the LM4900. The selection of bypass capacitors, especially  $C_{\text{B}}$ , is thus dependent upon desired PSRR requirements, click and pop performance as explained in the section, [PROPER SELECTION OF EXTERNAL COMPONENTS](#), system cost, and size constraints.

## SHUTDOWN FUNCTION

In order to reduce power consumption while not in use, the LM4900 contains a shutdown pin to externally turn off the amplifier's bias circuitry. This shutdown feature turns the amplifier off when a logic high is placed on the shutdown pin. The trigger point between a logic low and logic high level is typically half supply. It is best to switch between ground and supply to provide maximum device performance. By switching the shutdown pin to  $V_{\text{DD}}$ , the LM4900 supply current draw will be minimized in idle mode. While the device will be disabled with shutdown pin voltages less than  $V_{\text{DD}}$ , the idle current may be greater than the typical value of 0.1μA. In either case, the shutdown pin should be tied to a definite voltage to avoid unwanted state changes.

In many applications, a microcontroller or microprocessor output is used to control the shutdown circuitry which provides a quick, smooth transition into shutdown. Another solution is to use a single-pole, single-throw switch in conjunction with an external pull-up resistor. When the switch is closed, the shutdown pin is connected to ground and enables the amplifier. If the switch is open, then the external pull-up resistor will disable the LM4900. This scheme ensures that the shutdown pin will not float, thus preventing unwanted state changes.

## PROPER SELECTION OF EXTERNAL COMPONENTS

Proper selection of external components in applications using integrated power amplifiers is critical to optimize device and system performance. While the LM4900 is tolerant to a variety of external component combinations, consideration to component values must be used to maximize overall system quality.

The LM4900 is unity-gain stable, giving a designer maximum system flexibility. The LM4900 should be used in low gain configurations to minimize THD+N values, and maximize the signal to noise ratio. Low gain configurations require large input signals to obtain a given output power. Input signals equal to or greater than 1 V<sub>rms</sub> are available from sources such as audio codecs. Please refer to the section, [AUDIO POWER AMPLIFIER DESIGN](#), for a more complete explanation of proper gain selection.

Besides gain, one of the major considerations is the closed-loop bandwidth of the amplifier. To a large extent, the bandwidth is dictated by the choice of external components shown in [Figure 1](#). The input coupling capacitor,  $C_{\text{i}}$ , forms a first order high pass filter which limits low frequency response. This value should be chosen based on needed frequency response for a few distinct reasons.



## SELECTION OF INPUT CAPACITOR SIZE

Large input capacitors are both expensive and space hungry for portable designs. Clearly, a certain sized capacitor is needed to couple in low frequencies without severe attenuation. But in many cases the speakers used in portable systems, whether internal or external, have little ability to reproduce signals below 150Hz. In this case using a large input capacitor may not increase system performance.

In addition to system cost and size, click and pop performance is effected by the size of the input coupling capacitor,  $C_i$ . A larger input coupling capacitor requires more charge to reach its quiescent DC voltage (nominally  $\frac{1}{2} V_{DD}$ ). This charge comes from the output via the feedback and is apt to create pops upon device enable. Thus, by minimizing the capacitor size based on necessary low frequency response, turn-on pops can be minimized.

Besides minimizing the input capacitor size, careful consideration should be paid to the bypass capacitor value. Bypass capacitor,  $C_B$ , is the most critical component to minimize turn-on pops since it determines how fast the LM4900 turns on. The slower the LM4900's outputs ramp to their quiescent DC voltage (nominally  $\frac{1}{2} V_{DD}$ ), the smaller the turn-on pop. Choosing  $C_B$  equal to 1.0  $\mu\text{F}$  along with a small value of  $C_i$  (in the range of 0.1 $\mu\text{F}$  to 0.39 $\mu\text{F}$ ), should produce a clickless and popless shutdown function. While the device will function properly, (no oscillations or motorboating), with  $C_B$  equal to 0.1 $\mu\text{F}$ , the device will be much more susceptible to turn-on clicks and pops. Thus, a value of  $C_B$  equal to 1.0 $\mu\text{F}$  or larger is recommended in all but the most cost sensitive designs.

## AUDIO POWER AMPLIFIER DESIGN

### DESIGN A 300 mW/8 $\Omega$ AUDIO AMPLIFIER

Given:	
Power Output	300mWrms
Load Impedance	8 $\Omega$
Input Level	1Vrms
Input Impedance	20k $\Omega$
Bandwidth	100Hz–20 kHz $\pm$ 0.25dB

A designer must first determine the minimum supply rail to obtain the specified output power. By extrapolating from the Output Power vs Supply Voltage graphs in the [TYPICAL PERFORMANCE CHARACTERISTICS](#) section, the supply rail can be easily found. A second way to determine the minimum supply rail is to calculate the required  $V_{\text{opeak}}$  using [Equation 4](#) and add the dropout voltage. Using this method, the minimum supply voltage would be  $(V_{\text{opeak}} + (2 \cdot V_{\text{OD}}))$ , where  $V_{\text{OD}}$  is extrapolated from the Dropout Voltage vs Supply Voltage curve in the [TYPICAL PERFORMANCE CHARACTERISTICS](#) section.

$$V_{\text{opeak}} = \sqrt{(2R_L P_O)} \quad (4)$$

Using the Output Power vs Supply Voltage graph for an 8 $\Omega$  load, the minimum supply rail is 3.5V. But since 5V is a standard supply voltage in most applications, it is chosen for the supply rail. Extra supply voltage creates headroom that allows the LM4900 to reproduce peaks in excess of 700 mW without producing audible distortion. At this time, the designer must make sure that the power supply choice along with the output impedance does not violate the conditions explained in the [POWER DISSIPATION](#) section.

Once the power dissipation equations have been addressed, the required differential gain can be determined from [Equation 5](#).

$$A_{VD} \geq \sqrt{(P_O R_L)} / (V_{IN}) = V_{\text{orms}} / V_{\text{inrms}} \quad (5)$$

$$R_F / R_i = A_{VD} / 2 \quad (6)$$

From [Equation 5](#), the minimum  $A_{VD}$  is 1.55; use  $A_{VD} = 2$ .

Since the desired input impedance was 20 k $\Omega$ , and with a  $A_{VD}$  of 2, a ratio of 1:1 of  $R_F$  to  $R_i$  results in an allocation of  $R_i = R_F = 20$  k $\Omega$ . The final design step is to address the bandwidth requirements which must be stated as a pair of  $-3$  dB frequency points. Five times away from a pole gives 0.17 dB down from passband response which is better than the required  $\pm 0.25$  dB specified.

$$f_L = 100\text{Hz} / 5 = 20\text{Hz} \quad (7)$$

$$f_H = 20\text{kHz} \times 5 = 100\text{kHz} \quad (8)$$



As stated in the [EXTERNAL COMPONENTS DESCRIPTION](#) section,  $R_i$  in conjunction with  $C_i$  create a highpass filter.

$$C_i \geq \frac{1}{2\pi R_i f_c} \tag{9}$$

$$C_i \geq 1/(2\pi * 20 \text{ k}\Omega * 20 \text{ Hz}) = 0.397\mu\text{F}; \quad \text{use } 0.39\mu\text{F} \tag{10}$$

The high frequency pole is determined by the product of the desired high frequency pole,  $f_H$ , and the differential gain,  $A_{VD}$ . With a  $A_{VD} = 2$  and  $f_H = 100\text{kHz}$ , the resulting  $\text{GBWP} = 100\text{kHz}$  which is much smaller than the LM4900 GBWP of 25MHz. This figure displays that if a designer has a need to design an amplifier with a higher differential gain, the LM4900 can still be used without running into bandwidth problems.

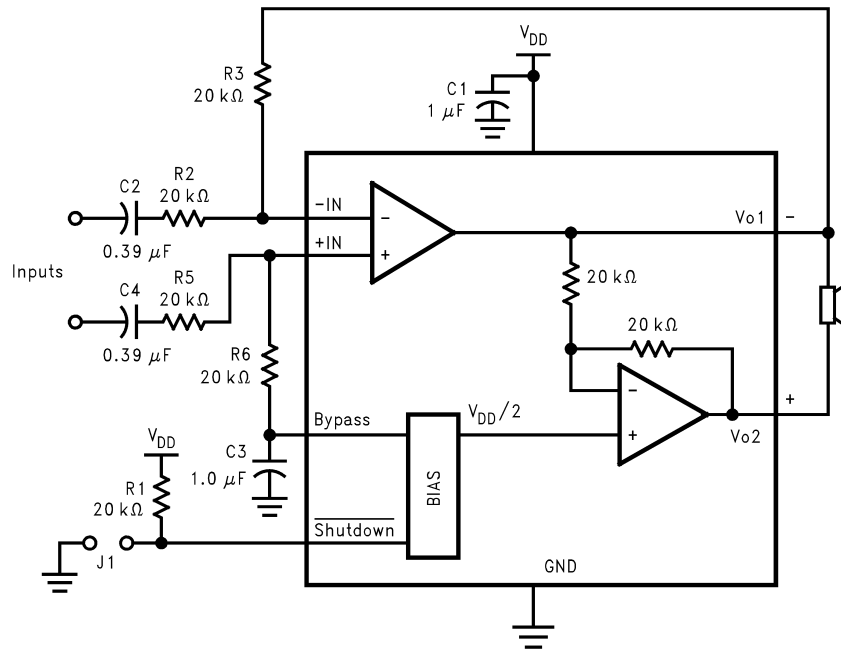


Figure 47. Differential Amplifier Configuration for LM4900

---

## REVISION HISTORY

Changes from Revision C (April 2013) to Revision D	Page
• Changed layout of National Data Sheet to TI format .....	<a href="#">17</a>

---

## IMPORTANT NOTICE

Texas Instruments Incorporated and its subsidiaries (TI) reserve the right to make corrections, enhancements, improvements and other changes to its semiconductor products and services per JESD46, latest issue, and to discontinue any product or service per JESD48, latest issue. Buyers should obtain the latest relevant information before placing orders and should verify that such information is current and complete. All semiconductor products (also referred to herein as "components") are sold subject to TI's terms and conditions of sale supplied at the time of order acknowledgment.

TI warrants performance of its components to the specifications applicable at the time of sale, in accordance with the warranty in TI's terms and conditions of sale of semiconductor products. Testing and other quality control techniques are used to the extent TI deems necessary to support this warranty. Except where mandated by applicable law, testing of all parameters of each component is not necessarily performed.

TI assumes no liability for applications assistance or the design of Buyers' products. Buyers are responsible for their products and applications using TI components. To minimize the risks associated with Buyers' products and applications, Buyers should provide adequate design and operating safeguards.

TI does not warrant or represent that any license, either express or implied, is granted under any patent right, copyright, mask work right, or other intellectual property right relating to any combination, machine, or process in which TI components or services are used. Information published by TI regarding third-party products or services does not constitute a license to use such products or services or a warranty or endorsement thereof. Use of such information may require a license from a third party under the patents or other intellectual property of the third party, or a license from TI under the patents or other intellectual property of TI.

Reproduction of significant portions of TI information in TI data books or data sheets is permissible only if reproduction is without alteration and is accompanied by all associated warranties, conditions, limitations, and notices. TI is not responsible or liable for such altered documentation. Information of third parties may be subject to additional restrictions.

Resale of TI components or services with statements different from or beyond the parameters stated by TI for that component or service voids all express and any implied warranties for the associated TI component or service and is an unfair and deceptive business practice. TI is not responsible or liable for any such statements.

Buyer acknowledges and agrees that it is solely responsible for compliance with all legal, regulatory and safety-related requirements concerning its products, and any use of TI components in its applications, notwithstanding any applications-related information or support that may be provided by TI. Buyer represents and agrees that it has all the necessary expertise to create and implement safeguards which anticipate dangerous consequences of failures, monitor failures and their consequences, lessen the likelihood of failures that might cause harm and take appropriate remedial actions. Buyer will fully indemnify TI and its representatives against any damages arising out of the use of any TI components in safety-critical applications.

In some cases, TI components may be promoted specifically to facilitate safety-related applications. With such components, TI's goal is to help enable customers to design and create their own end-product solutions that meet applicable functional safety standards and requirements. Nonetheless, such components are subject to these terms.

No TI components are authorized for use in FDA Class III (or similar life-critical medical equipment) unless authorized officers of the parties have executed a special agreement specifically governing such use.

Only those TI components which TI has specifically designated as military grade or "enhanced plastic" are designed and intended for use in military/aerospace applications or environments. Buyer acknowledges and agrees that any military or aerospace use of TI components which have **not** been so designated is solely at the Buyer's risk, and that Buyer is solely responsible for compliance with all legal and regulatory requirements in connection with such use.

TI has specifically designated certain components as meeting ISO/TS16949 requirements, mainly for automotive use. In any case of use of non-designated products, TI will not be responsible for any failure to meet ISO/TS16949.

### Products

Audio	<a href="http://www.ti.com/audio">www.ti.com/audio</a>
Amplifiers	<a href="http://amplifier.ti.com">amplifier.ti.com</a>
Data Converters	<a href="http://dataconverter.ti.com">dataconverter.ti.com</a>
DLP® Products	<a href="http://www.dlp.com">www.dlp.com</a>
DSP	<a href="http://dsp.ti.com">dsp.ti.com</a>
Clocks and Timers	<a href="http://www.ti.com/clocks">www.ti.com/clocks</a>
Interface	<a href="http://interface.ti.com">interface.ti.com</a>
Logic	<a href="http://logic.ti.com">logic.ti.com</a>
Power Mgmt	<a href="http://power.ti.com">power.ti.com</a>
Microcontrollers	<a href="http://microcontroller.ti.com">microcontroller.ti.com</a>
RFID	<a href="http://www.ti-rfid.com">www.ti-rfid.com</a>
OMAP Applications Processors	<a href="http://www.ti.com/omap">www.ti.com/omap</a>
Wireless Connectivity	<a href="http://www.ti.com/wirelessconnectivity">www.ti.com/wirelessconnectivity</a>

### Applications

Automotive and Transportation	<a href="http://www.ti.com/automotive">www.ti.com/automotive</a>
Communications and Telecom	<a href="http://www.ti.com/communications">www.ti.com/communications</a>
Computers and Peripherals	<a href="http://www.ti.com/computers">www.ti.com/computers</a>
Consumer Electronics	<a href="http://www.ti.com/consumer-apps">www.ti.com/consumer-apps</a>
Energy and Lighting	<a href="http://www.ti.com/energy">www.ti.com/energy</a>
Industrial	<a href="http://www.ti.com/industrial">www.ti.com/industrial</a>
Medical	<a href="http://www.ti.com/medical">www.ti.com/medical</a>
Security	<a href="http://www.ti.com/security">www.ti.com/security</a>
Space, Avionics and Defense	<a href="http://www.ti.com/space-avionics-defense">www.ti.com/space-avionics-defense</a>
Video and Imaging	<a href="http://www.ti.com/video">www.ti.com/video</a>

### TI E2E Community

[e2e.ti.com](http://e2e.ti.com)