



March 2006

# LM4920 Boomer® Audio Power Amplifier Series

## Ground-Referenced, Ultra Low Noise, Fixed Gain, 80mW Stereo Headphone Amplifier

### General Description

The LM4920 is a ground referenced, fixed-gain audio power amplifier capable of delivering 80mW of continuous average power into a 16Ω single-ended load with less than 1% THD+N from a 3V power supply.

The LM4920 features a new circuit technology that utilizes a charge pump to generate a negative reference voltage. This allows the outputs to be biased about ground, thereby eliminating output-coupling capacitors typically used with normal single-ended loads.

Boomer audio power amplifiers were designed specifically to provide high quality output power with a minimal amount of external components. The LM4920 does not require output coupling capacitors or bootstrap capacitors, and therefore is ideally suited for mobile phone and other low voltage applications where minimal power consumption is a primary requirement.

The LM4920 features a low-power consumption shutdown mode selectable for either channel separately. This is accomplished by driving either the SD\_RC (Shutdown Right Channel) or SD\_LC (Shutdown Left Channel) (or both) pins with logic low, depending on which channel is desired shutdown. Additionally, the LM4920 features an internal thermal shutdown protection mechanism.

The LM4920 contains advanced pop & click circuitry that eliminates noises which would otherwise occur during turn-on and turn-off transitions.

The LM4920 has an internal fixed gain of 1.5V/V.

### Key Specifications

■ Improved PSRR at 217Hz	70dB (typ)
■ Power Output at $V_{DD} = 3V$ , $R_L = 16\Omega$ , THD $\leq 1\%$	80mW (typ)
■ Shutdown Current	0.01μA (typ)
■ Internal Fixed Gain	1.5V/V (typ)
■ Operating Voltage	1.6V to 4.2V

### Features

- Fixed Logic Levels
- Ground referenced outputs
- High PSRR
- Available in space-saving micro SMD package
- Ultra low current shutdown mode
- Improved pop & click circuitry eliminates noises during turn-on and turn-off transitions
- No output coupling capacitors, snubber networks, bootstrap capacitors, or gain-setting resistors required
- Shutdown either channel independently

### Applications

- Mobile Phones
- MP3 Players
- PDAs
- Portable electronic devices
- Notebook PCs

LM4920 Ground-Referenced, Ultra Low Noise, Fixed Gain, 80mW Stereo Headphone Amplifier

Boomer® is a registered trademark of National Semiconductor Corporation.

# Typical Application

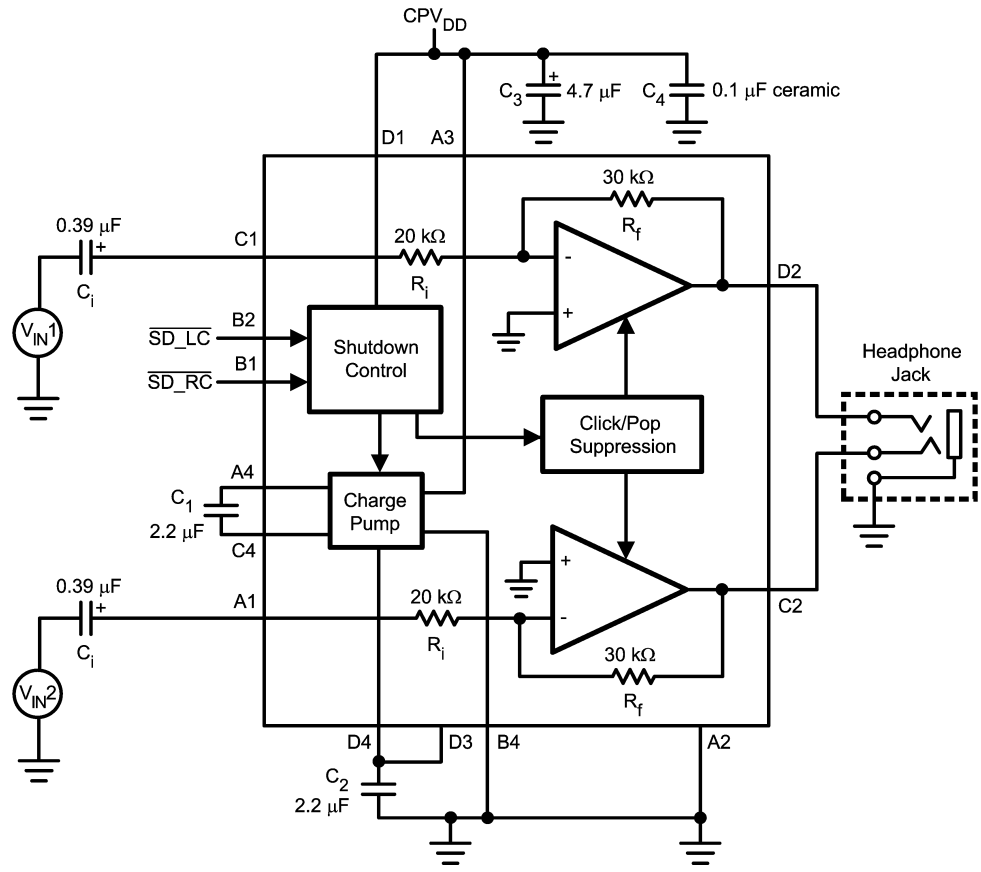

201793B8

FIGURE 1. Typical Audio Amplifier Application Circuit

## Connection Diagrams

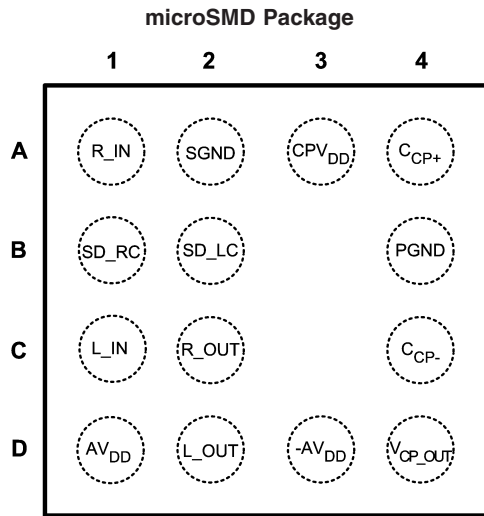

Top View  
Order Number LM4920TL  
See NS Package Number TLE1411A

20179309

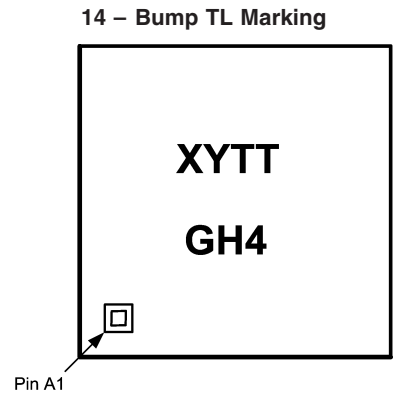

Top View  
XY – Date Code  
TT – Lot Traceability  
G – Boomer Family  
H4 – LM4920TL

20179378

## Pin Descriptions

Pin	Name	Function
A1	R_IN	Right Channel Input
A2	SGND	Signal Ground
A3	CPV <sub>DD</sub>	Charge Pump Power Supply
A4	C <sub>CP+</sub>	Positive Terminal - Charge Pump Flying Capacitor
B1	SD_RC	Active-Low Shutdown, Right Channel
B2	SD_LC	Active-Low Shutdown, Left Channel
B4	PGND	Power Ground
C1	L_IN	Left Channel Input
C2	R_OUT	Right Channel Input
C4	C <sub>CP-</sub>	Negative Terminal - Charge Pump Flying Capacitor
D1	+AV <sub>DD</sub>	Positive Power Supply - Amplifier
D2	L_OUT	Left Channel Output
D3	-AV <sub>DD</sub>	Negative Power Supply - Amplifier
D4	V <sub>CP_OUT</sub>	Charge Pump Power Output

**Absolute Maximum Ratings** (Note 2)

If Military/Aerospace specified devices are required, please contact the National Semiconductor Sales Office/Distributors for availability and specifications.

Supply Voltage	4.5V
Storage Temperature	-65°C to +150°C
Input Voltage	-0.3V to $V_{DD} + 0.3V$
Power Dissipation (Note 3)	Internally Limited
ESD Susceptibility (Note 4)	2000V
ESD Susceptibility (Note 5)	200V

Junction Temperature	150°C
Thermal Resistance	
$\theta_{JA}$ (typ) TLE1411A (Note 11)	86°C/W

**Operating Ratings**

Temperature Range	
$T_{MIN} \leq T_A \leq T_{MAX}$	-40°C $\leq T_A \leq$ 85°C
Supply Voltage ( $V_{DD}$ )	1.6V $\leq V_{DD} \leq$ 4.2V

**Electrical Characteristics  $V_{DD} = 3V$**  (Note 1)

The following specifications apply for  $V_{DD} = 3V$  and 16 $\Omega$  load unless otherwise specified. Limits apply to  $T_A = 25^\circ C$ .

Symbol	Parameter	Conditions	LM4920		Units (Limits)
			Typ (Note 6)	Limit (Notes 7, 8)	
$I_{DD}$	Quiescent Power Supply Current Full Power Mode	$V_{IN} = 0V$ , inputs terminated both channels enabled	7	10	mA (max)
		$V_{IN} = 0V$ , inputs terminated one channel enabled	5		mA
$I_{SD}$	Shutdown Current	$V_{SD\_LC} = V_{SD\_RC} = GND$	0.1	1.8	$\mu A$ (max)
$V_{OS}$	Output Offset Voltage	$R_L = 32\Omega$ , $V_{IN} = 0V$	0.7	5	mV (max)
$A_V$	Voltage Gain		-1.5		V/V
$\Delta A_V$	Gain Match		1		%
$R_{IN}$	Input Resistance		20	15	k $\Omega$ (min)
				25	k $\Omega$ (max)
$P_O$	Output Power	THD+N = 1% (max); f = 1kHz, $R_L = 16\Omega$ , one channel	80		mW
		THD+N = 1% (max); f = 1kHz, $R_L = 32\Omega$ , one channel	65		mW
		THD+N = 1% (max); f = 1kHz, $R_L = 16\Omega$ , (two channels in phase)	43	38	mW (min)
		THD+N = 1% (max); f = 1kHz, $R_L = 32\Omega$ , (two channels in phase)	50	45	mW (min)
THD+N	Total Harmonic Distortion + Noise	$P_O = 60mW$ , f = 1kHz, $R_L = 16\Omega$ single channel	0.04		%
		$P_O = 50mW$ , f = 1kHz, $R_L = 32\Omega$ single channel	0.03		
PSRR	Power Supply Rejection Ratio Full Power Mode	$V_{RIPPLE} = 200mVp-p$ , Input Referred			dB
		f = 217Hz	70		
		f = 1kHz	65		
		f = 20kHz	50		
SNR	Signal-to-Noise Ratio	$R_L = 32\Omega$ , $P_{OUT} = 20mW$ , (A-weighted) f = 1kHz, BW = 20Hz to 22kHz	100		dB
$V_{IH}$	Shutdown Input Voltage High	$V_{DD} = 1.8V$ to 4.2V		1.2	V (min)
$V_{IL}$	Shutdown Input Voltage Low	$V_{DD} = 1.8V$ to 4.2V		0.45	V (max)
$X_{TALK}$	Crosstalk	$R_L = 16\Omega$ , $P_O = 1.6mW$ , f = 1kHz	60		dB
$Z_{OUT}$	Output Impedance	$V_{SD-LC} = V_{SD-RC} = GND$ Input Terminated	50	30	k $\Omega$
		Input not terminated	$\infty$		

## Electrical Characteristics $V_{DD} = 3V$ (Note 1) (Continued)

The following specifications apply for  $V_{DD} = 3V$  and  $16\Omega$  load unless otherwise specified. Limits apply to  $T_A = 25^\circ C$ .

Symbol	Parameter	Conditions	LM4920		Units (Limits)
			Typ (Note 6)	Limit (Notes 7, 8)	
$Z_{OUT}$	Output Impedance	$V_{SD-LC} = V_{SD-RC} = GND$ $-500mV \leq V_{OUT} \leq +500mV$ (Note 12)	8	2	k $\Omega$ (min)
$I_L$	Input Leakage		$\pm 0.1$		nA

**Note 1:** All voltages are measured with respect to the GND pin unless otherwise specified.

**Note 2:** Absolute Maximum Ratings indicate limits beyond which damage to the device may occur. Operating Ratings indicate conditions for which the device is functional but do not guarantee specific performance limits. Electrical Characteristics state DC and AC electrical specifications under particular test conditions that guarantee specific performance limits. This assumes that the device is within the Operating Ratings. Specifications are not guaranteed for parameters where no limit is given; however, the typical value is a good indication of device performance.

**Note 3:** The maximum power dissipation must be derated at elevated temperatures and is dictated by  $T_{JMAX}$ ,  $\theta_{JA}$ , and the ambient temperature,  $T_A$ . The maximum allowable power dissipation is  $P_{DMAX} = (T_{JMAX} - T_A) / \theta_{JA}$  or the number given in Absolute Maximum Ratings, whichever is lower. For the LM4920, see power de-rating currents for more information.

**Note 4:** Human body model, 100pF discharged through a 1.5k $\Omega$  resistor.

**Note 5:** Machine Model, 220pF - 240pF discharged through all pins.

**Note 6:** Typical values are measured at  $25^\circ C$  and represent the parametric norm.

**Note 7:** Limits are guaranteed to National's AOQL (Average Outgoing Quality Level).

**Note 8:** Datasheet min/max specification limits are guaranteed by design, test, or statistical analysis.

**Note 9:** If the product is in shutdown mode and  $V_{DD}$  exceeds 4.2V (to a max of 4.5V  $V_{DD}$ ), then most of the excess current will flow through the ESD protection circuits. If the source impedance limits the current to a max of 10mA, then the part will be protected. If the part is enabled when  $V_{DD}$  is above 4.5V, circuit performance will be curtailed or the part may be permanently damaged.

**Note 10:** Human body model, 100pF discharged through a 1.5k $\Omega$  resistor.

**Note 11:**  $\theta_{JA}$  value is measured with the device mounted on a PCB with a 3" x 1.5", 1oz copper heatsink.

**Note 12:**  $V_{OUT}$  refers to signal applied to the LM4920 outputs.

## External Components Description (Figure 1)

Components		Functional Description
1.	$C_i$	Input coupling capacitor which blocks the DC voltage at the amplifier's input terminals. Also creates a high-pass filter with $R_i$ at $f_C = 1/(2\pi R_i C_i)$ . Refer to the section <b>Proper Selection of External Components</b> , for an explanation of how to determine the value of $C_i$ .
2.	$C_1$	Flying capacitor. Low ESR ceramic capacitor ( $\leq 100m\Omega$ )
3.	$C_2$	Output capacitor. Low ESR ceramic capacitor ( $\leq 100m\Omega$ )
4.	$C_3$	Tantalum capacitor. Supply bypass capacitor which provides power supply filtering. Refer to the Power Supply Bypassing section for information concerning proper placement and selection of the supply bypass capacitor.
5.	$C_4$	Ceramic capacitor. Supply bypass capacitor which provides power supply filtering. Refer to the Power Supply Bypassing section for information concerning proper placement and selection of the supply bypass capacitor.

# Typical Performance Characteristics

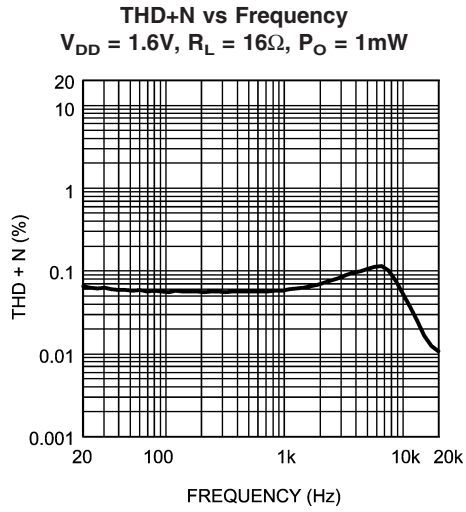

20179328

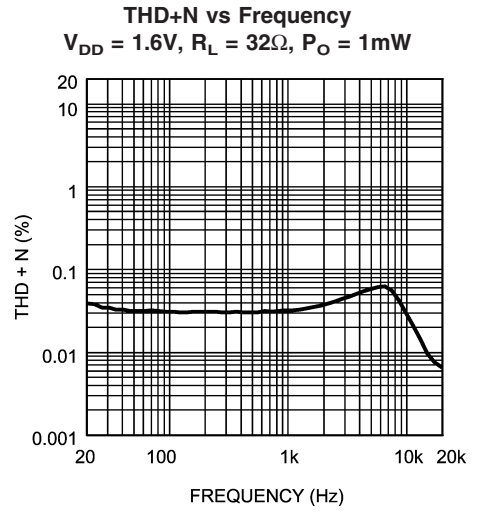

20179329

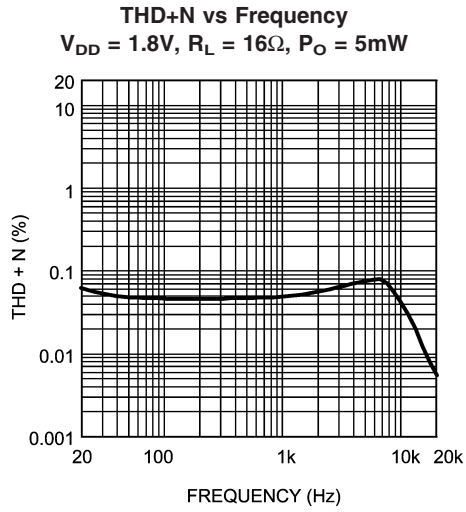

20179330

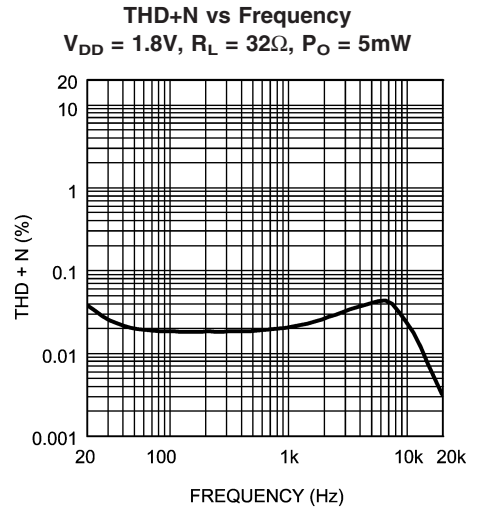

20179331

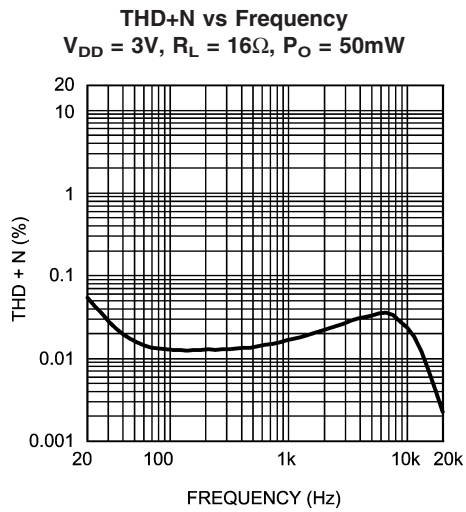

20179332

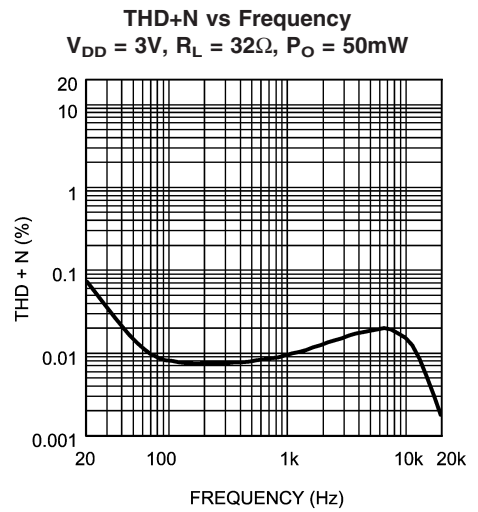

20179333

Typical Performance Characteristics (Continued)

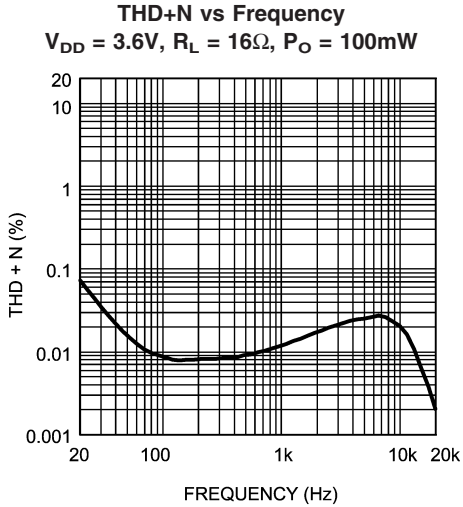

20179334

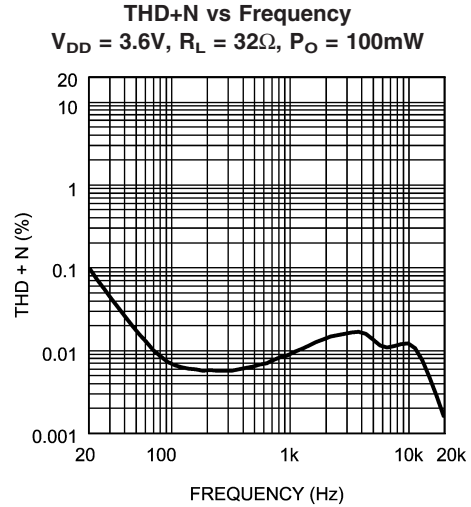

20179335

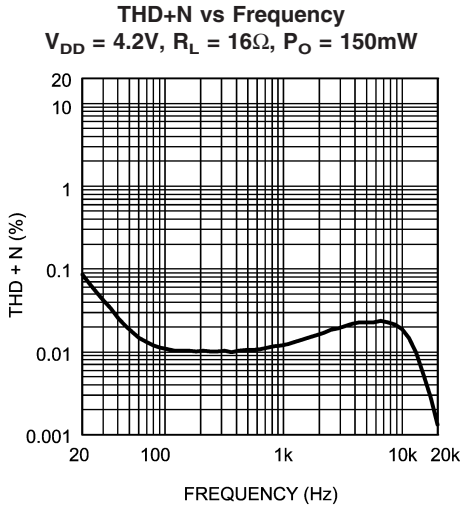

20179336

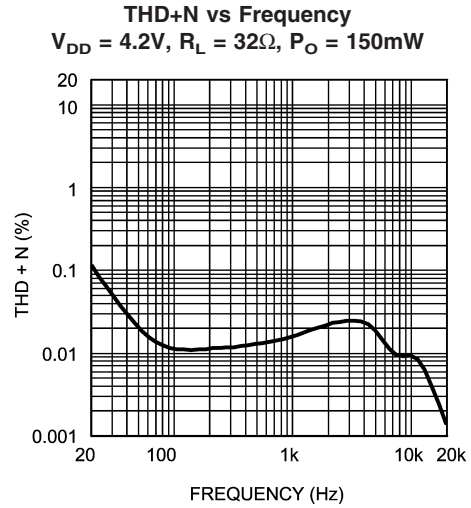

20179337

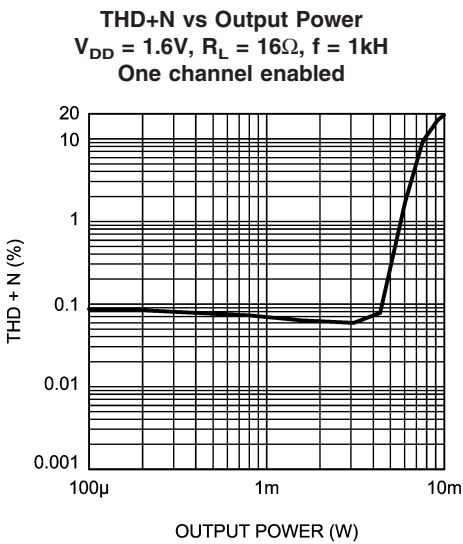

20179347

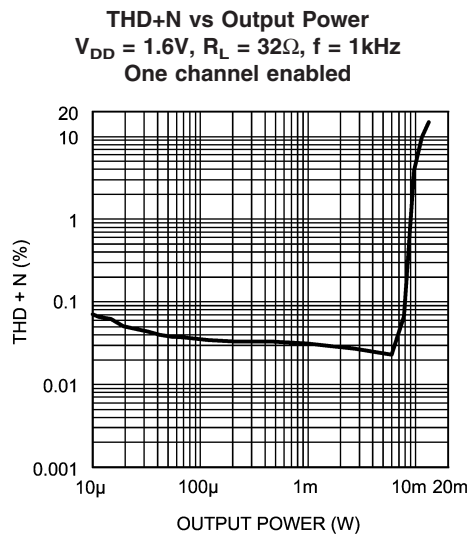

20179349

Typical Performance Characteristics (Continued)

**THD+N vs Output Power**  
 $V_{DD} = 1.6V, R_L = 16\Omega, f = 1kHz$   
 Two channels in phase

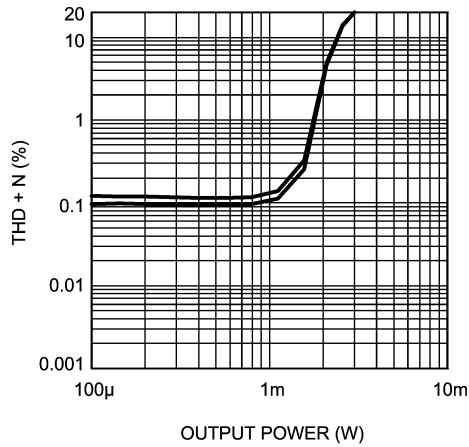

20179351

**THD+N vs Output Power**  
 $V_{DD} = 1.6V, R_L = 32\Omega, f = 1kHz$   
 Two channels in phase

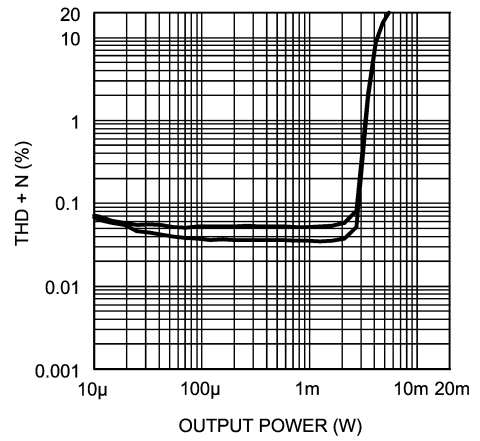

20179353

**THD+N vs Output Power**  
 $V_{DD} = 1.8V, R_L = 16\Omega, f = 1kHz$   
 One channel enabled

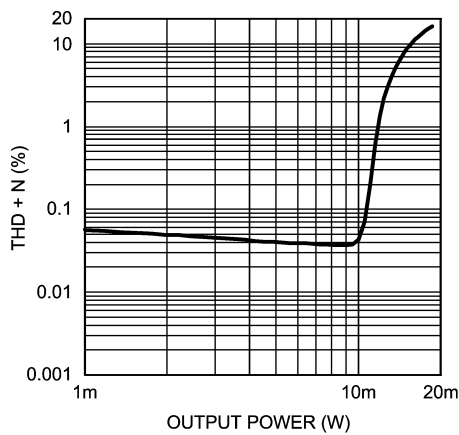

20179359

**THD+N vs Output Power**  
 $V_{DD} = 1.8V, R_L = 32\Omega, f = 1kHz$   
 One channel enabled

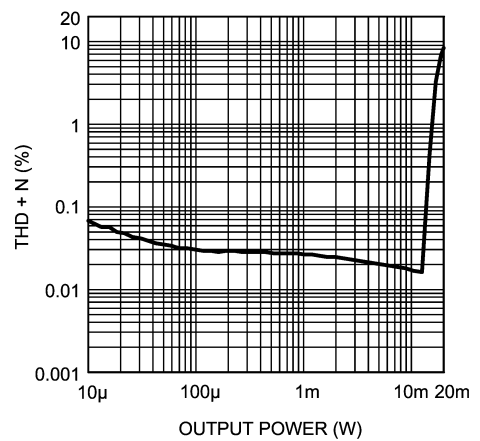

20179361

**THD+N vs Output Power**  
 $V_{DD} = 1.8V, R_L = 16\Omega, f = 1kHz$   
 Two channels in phase

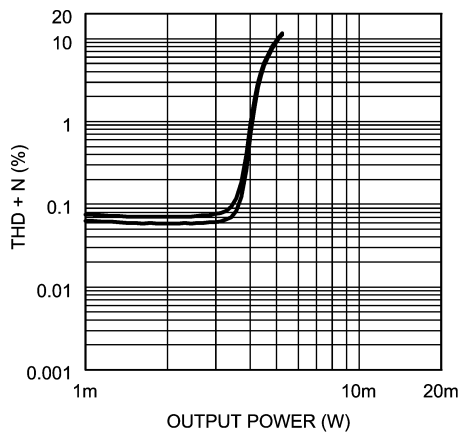

20179363

**THD+N vs Output Power**  
 $V_{DD} = 1.8V, R_L = 32\Omega, f = 1kHz$   
 Two channels in phase

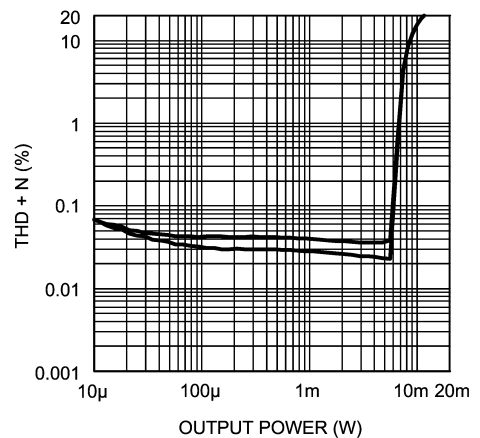

20179365



Typical Performance Characteristics (Continued)

**THD+N vs Output Power**  
 $V_{DD} = 3.0V, R_L = 16\Omega, f = 1kHz$   
 One channel enabled

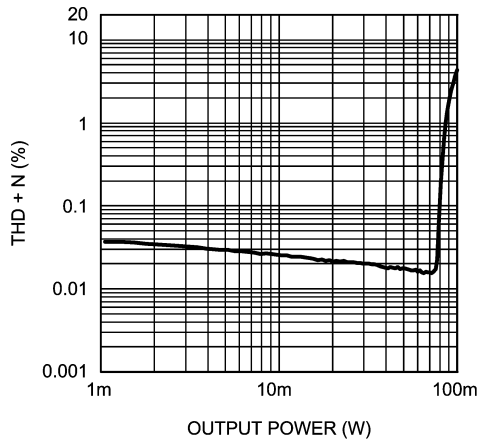

201793G2

**THD+N vs Output Power**  
 $V_{DD} = 3.0V, R_L = 32\Omega, f = 1kHz$   
 One channel enabled

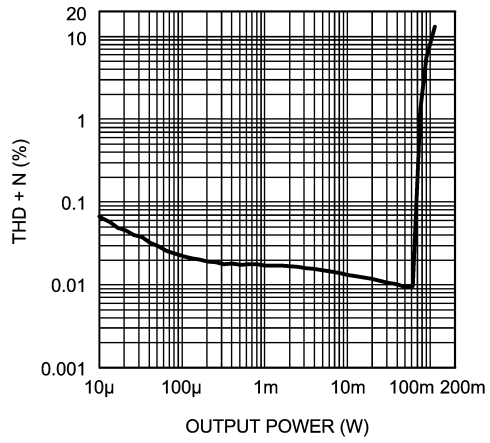

201793E1

**THD+N vs Output Power**  
 $V_{DD} = 3.0V, R_L = 16\Omega, f = 1kHz$   
 Two channels in phase

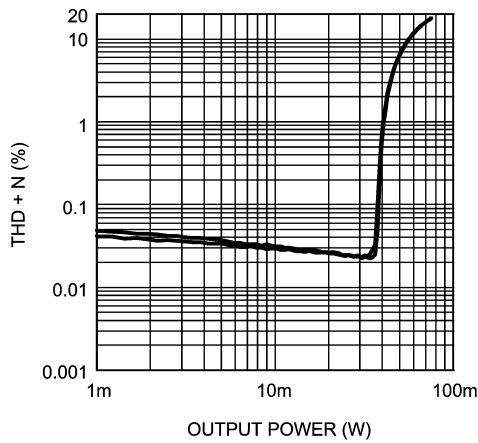

201793G4

**THD+N vs Output Power**  
 $V_{DD} = 3.0V, R_L = 32\Omega, f = 1kHz$   
 Two channels in phase

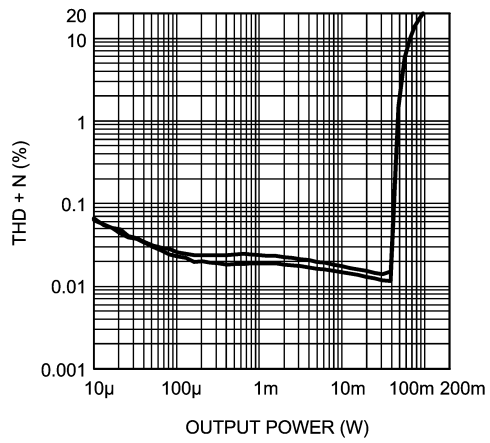

201793E5

**THD+N vs Output Power**  
 $V_{DD} = 3.6V, R_L = 16\Omega, f = 1kHz$   
 One channel enabled

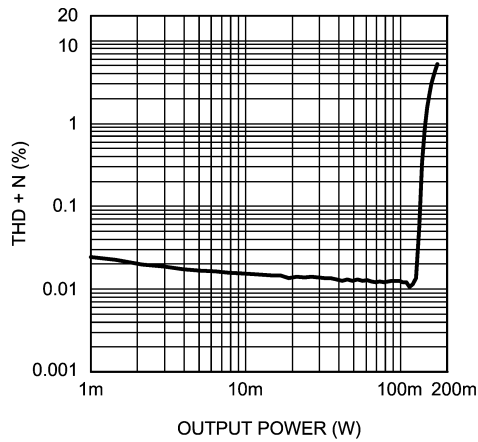

201793F1

**THD+N vs Output Power**  
 $V_{DD} = 3.6V, R_L = 32\Omega, f = 1kHz$   
 One channel enabled

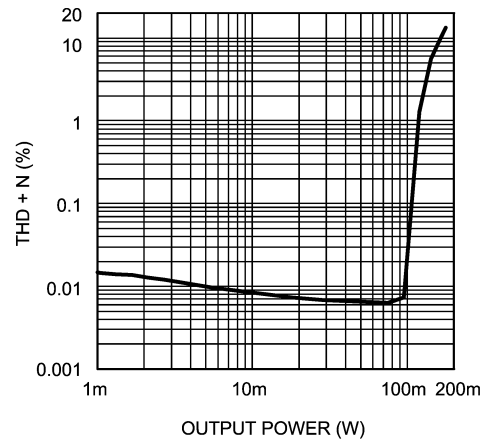

201793F3

Typical Performance Characteristics (Continued)

**THD+N vs Output Power**  
 $V_{DD} = 3.6V, R_L = 16\Omega, f = 1kHz$   
 Two channels in phase

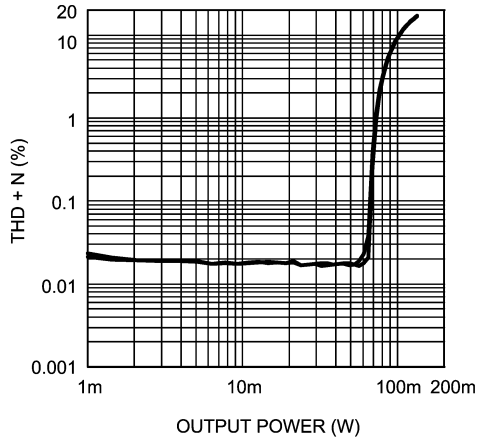

201793F5

**THD+N vs Output Power**  
 $V_{DD} = 3.6V, R_L = 32\Omega, f = 1kHz$   
 two channels in phase

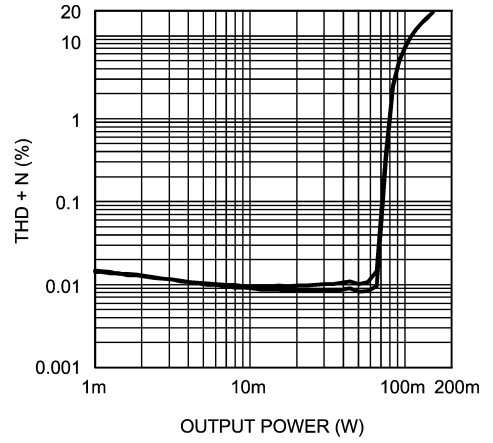

201793F7

**THD+N vs Output Power**  
 $V_{DD} = 4.2V, R_L = 16\Omega, f = 1kHz$   
 One channel enabled

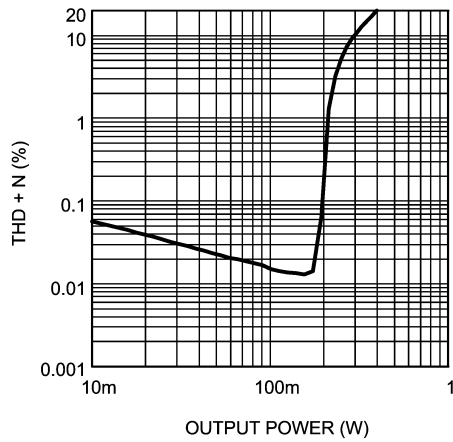

20179373

**THD+N vs Output Power**  
 $V_{DD} = 4.2V, R_L = 32\Omega, f = 1kHz$   
 One channel enabled

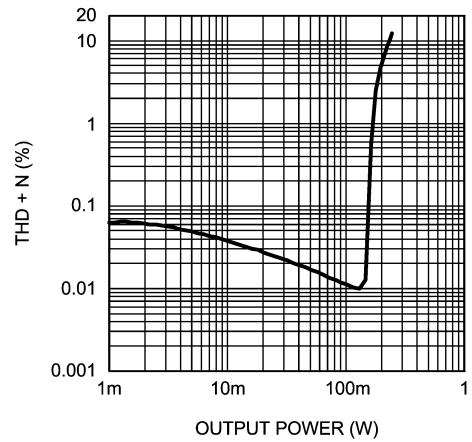

20179380

**THD+N vs Output Power**  
 $V_{DD} = 4.2V, R_L = 16\Omega, f = 1kHz$   
 Two channels in phase

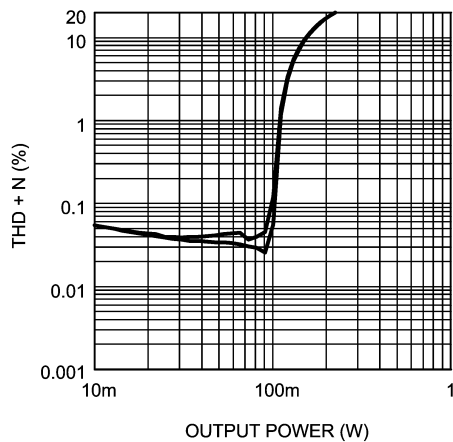

20179382

**THD+N vs Output Power**  
 $V_{DD} = 4.2V, R_L = 32\Omega, f = 1kHz$   
 Two channels in phase

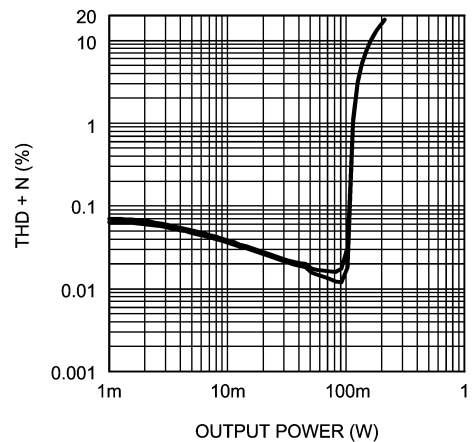

20179384

Typical Performance Characteristics (Continued)

PSRR vs Frequency  
 $V_{DD} = 1.6V, R_L = 16\Omega$

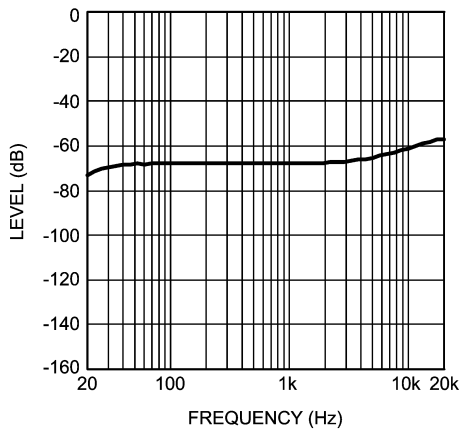

20179340

PSRR vs Frequency  
 $V_{DD} = 1.6V, R_L = 32\Omega$

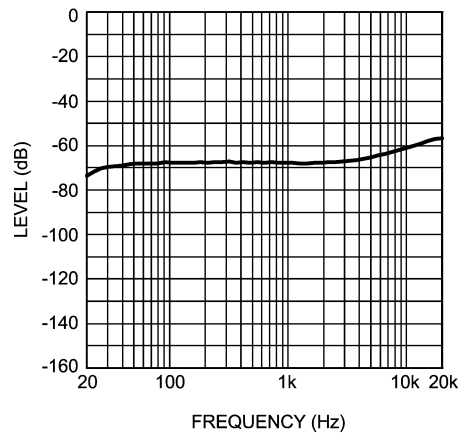

20179341

PSRR vs Frequency  
 $V_{DD} = 3V, R_L = 16\Omega$

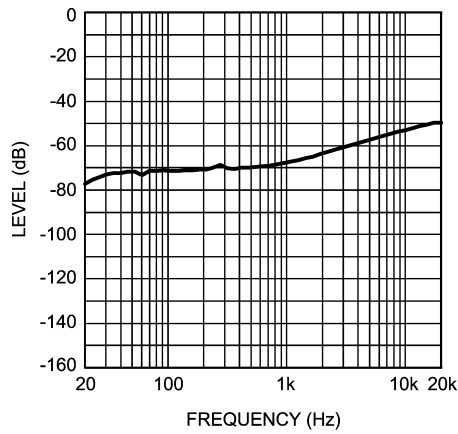

20179342

PSRR vs Frequency  
 $V_{DD} = 3V, R_L = 32\Omega$

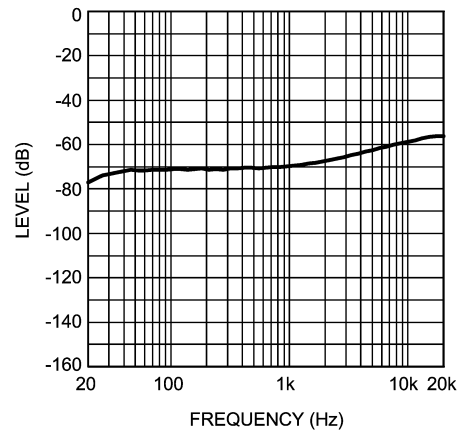

20179343

PSRR vs Frequency  
 $V_{DD} = 4.2V, R_L = 16\Omega$

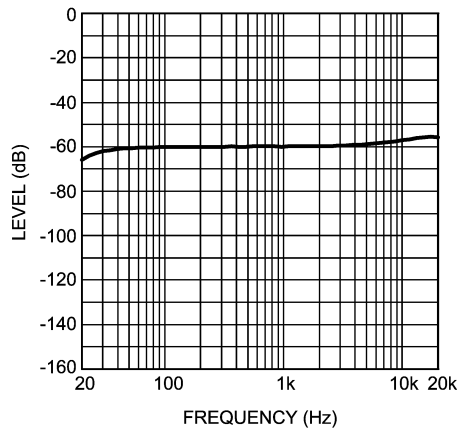

20179344

PSRR vs Frequency  
 $V_{DD} = 4.2V, R_L = 32\Omega$

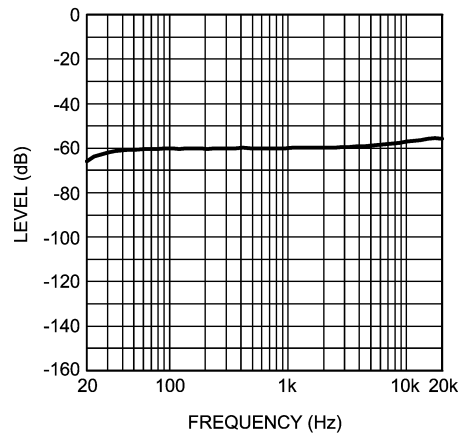

20179345

# Typical Performance Characteristics (Continued)

**Output Power vs Supply Voltage**  
 $R_L = 16\Omega$ , one channel

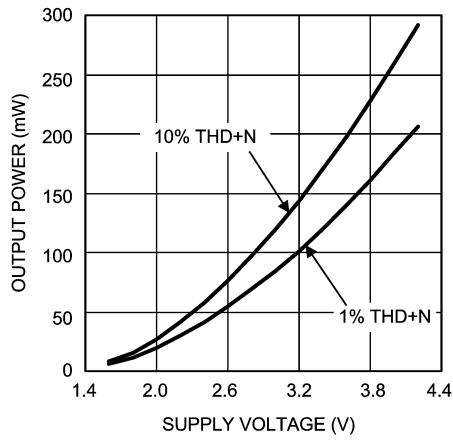

20179338

**Output Power vs Supply Voltage**  
 $R_L = 32\Omega$ , one channel

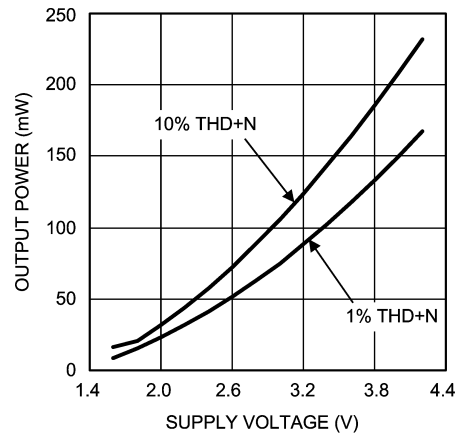

20179339

**Output Power vs Supply Voltage**  
 $R_L = 16\Omega$ , 2 channels in phase

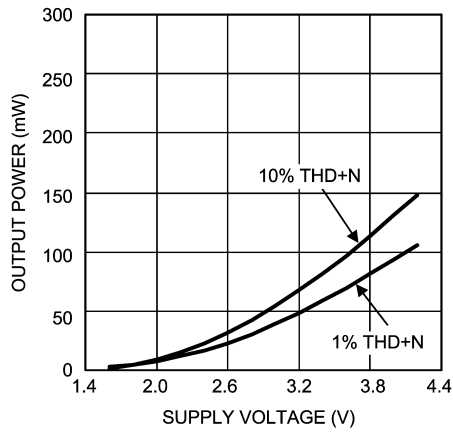

201793G8

**Output Power vs Supply Voltage**  
 $R_L = 32\Omega$ , 2 channels in phase

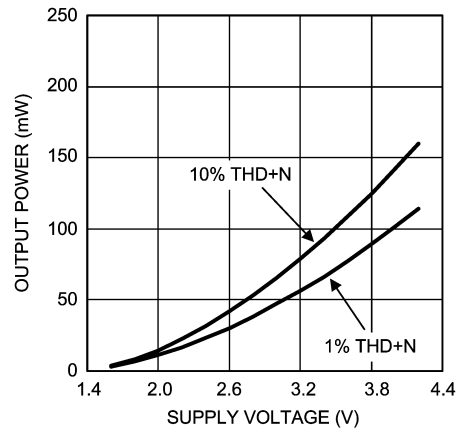

201793G9

**Supply Current vs Supply Voltage**  
 $R_L = 16\Omega$

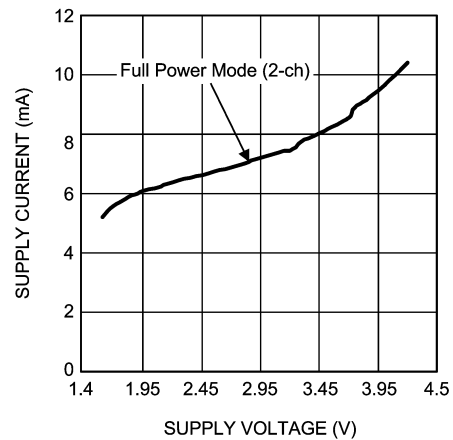

20179310

## Application Information

### SUPPLY VOLTAGE SEQUENCING

It is a good general practice to first apply the supply voltage to a CMOS device before any other signal or supply on other pins. This is also true for the LM4920 audio amplifier which is a CMOS device.

Before applying any signal to the inputs or shutdown pins of the LM4920, it is important to apply a supply voltage to the  $V_{DD}$  pins. After the device has been powered, signals may be applied to the shutdown pins (see MICRO POWER SHUTDOWN) and input pins.

### ELIMINATING THE OUTPUT COUPLING CAPACITOR

The LM4920 features a low noise inverting charge pump that generates an internal negative supply voltage. This allows the outputs of the LM4920 to be biased about GND instead of a nominal DC voltage, like traditional headphone amplifiers. Because there is no DC component, the large DC blocking capacitors (typically 220 $\mu$ F) are not necessary. The coupling capacitors are replaced by two, small ceramic charge pump capacitors, saving board space and cost.

Eliminating the output coupling capacitors also improves low frequency response. In traditional headphone amplifiers, the headphone impedance and the output capacitor form a high pass filter that not only blocks the DC component of the output, but also attenuates low frequencies, impacting the bass response. Because the LM4920 does not require the output coupling capacitors, the low frequency response of the device is not degraded by external components.

In addition to eliminating the output coupling capacitors, the ground referenced output nearly doubles the available dynamic range of the LM4920 when compared to a traditional headphone amplifier operating from the same supply voltage.

### OUTPUT TRANSIENT ('CLICK AND POPS') ELIMINATED

The LM4920 contains advanced circuitry that virtually eliminates output transients ('clicks and pops'). This circuitry prevents all traces of transients when the supply voltage is first applied or when the part resumes operation after coming out of shutdown mode.

### AMPLIFIER CONFIGURATION EXPLANATION

As shown in Figure 2, the LM4920 has two internal operational amplifiers. The two amplifiers have internally configured gain, the closed loop gain is set by selecting the ratio of  $R_f$  to  $R_i$ . Consequently, the gain for each channel of the IC is

$$A_V = -(R_f / R_i) = 1.5 \text{ V/V}$$

where  $R_f = 30\text{k}\Omega$  and  $R_i = 20\text{k}\Omega$ .

Since this is an output ground-referenced amplifier, by driving the headphone through  $R_{OUT}$  (Pin C2) and  $L_{OUT}$  (Pin D2), the LM4920 does not require output coupling capacitors. The typical single-ended amplifier configuration requires large, expensive output capacitors.

### POWER DISSIPATION

Power dissipation is a major concern when using any power amplifier and must be thoroughly understood to ensure a successful design. Equation 1 states the maximum power dissipation point for a single-ended amplifier operating at a given supply voltage and driving a specified output load.

$$P_{DMAX} = (V_{DD})^2 / (2\pi^2 R_L) \quad (1)$$

Since the LM4920 has two operational amplifiers in one package, the maximum internal power dissipation point is twice that of the number which results from Equation 1. Even with large internal power dissipation, the LM4920 does not require heat sinking over a large range of ambient temperatures. From Equation 1, assuming a 3V power supply and a 16 $\Omega$  load, the maximum power dissipation point is 28mW per amplifier. Thus the maximum package dissipation point is 56mW. The maximum power dissipation point obtained must not be greater than the power dissipation that results from Equation 2:

$$P_{DMAX} = (T_{JMAX} - T_A) / (\theta_{JA}) \quad (2)$$

For the micro SMD package,  $\theta_{JA} = 105^\circ\text{C/W}$ .  $T_{JMAX} = 150^\circ\text{C}$  for the LM4920. Depending on the ambient temperature,  $T_A$ , of the system surroundings, Equation 2 can be used to find the maximum internal power dissipation supported by the IC packaging. If the result of Equation 1 is greater than that of Equation 2, then either the supply voltage must be decreased, the load impedance increased or  $T_A$  reduced. For the typical application of a 3V power supply, with a 16 $\Omega$  load, the maximum ambient temperature possible without violating the maximum junction temperature is approximately 144 $^\circ\text{C}$  provided that device operation is around the maximum power dissipation point. Power dissipation is a function of output power and thus, if typical operation is not around the maximum power dissipation point, the ambient temperature may be increased accordingly.

### POWER SUPPLY BYPASSING

As with any power amplifier, proper supply bypassing is critical for low noise performance and high power supply rejection. Applications that employ a 3V power supply typically use a 4.7 $\mu$ F capacitor in parallel with a 0.1 $\mu$ F ceramic filter capacitor to stabilize the power supply's output, reduce noise on the supply line, and improve the supply's transient response. Keep the length of leads and traces that connect capacitors between the LM4920's power supply pin and ground as short as possible.

### MICRO POWER SHUTDOWN

The voltage applied to the  $\overline{\text{SD\_LC}}$  (shutdown left channel) pin and the  $\overline{\text{SD\_RC}}$  (shutdown right channel) pin controls the LM4920's shutdown function. When active, the LM4920's micropower shutdown feature turns off the amplifiers' bias circuitry, reducing the supply current. The trigger point is  $0.3 \cdot \text{CPV}_{DD}$  for a logic-low level, and  $0.7 \cdot \text{CPV}_{DD}$  for logic-high level. The low 0.01 $\mu$ A (typ) shutdown current is achieved by applying a voltage that is as near as ground as possible to the  $\overline{\text{SD\_LC}}/\overline{\text{SD\_RC}}$  pins. A voltage that is higher than ground may increase the shutdown current.

There are a few ways to control the micro-power shutdown. These include using a single-pole, single-throw switch, a microprocessor, or a microcontroller. When using a switch, connect an external 100k $\Omega$  pull-up resistor between the

## Application Information (Continued)

$\overline{SD\_LC/SD\_RC}$  pins and  $V_{DD}$ . Connect the switch between the  $\overline{SD\_LC/SD\_RC}$  pins and ground. Select normal amplifier operation by opening the switch. Closing the switch connects the  $\overline{SD\_LC/SD\_RC}$  pins to ground, activating micro-power shutdown. The switch and resistor guarantee that the  $\overline{SD\_LC/SD\_RC}$  pins will not float. This prevents unwanted state changes. In a system with a microprocessor or micro-controller, use a digital output to apply the control voltage to the  $\overline{SD\_LC/SD\_RC}$  pins. Driving the  $\overline{SD\_LC/SD\_RC}$  pins with active circuitry eliminates the pull-up resistor.

### SELECTING PROPER EXTERNAL COMPONENTS

Optimizing the LM4920's performance requires properly selecting external components. Though the LM4920 operates well when using external components with wide tolerances, best performance is achieved by optimizing component values.

#### Charge Pump Capacitor Selection

Use low ESR (equivalent series resistance) (<100m $\Omega$ ) ceramic capacitors with an X7R dielectric for best performance. Low ESR capacitors keep the charge pump output impedance to a minimum, extending the headroom on the negative supply. Higher ESR capacitors result in reduced output power from the audio amplifiers.

Charge pump load regulation and output impedance are affected by the value of the flying capacitor (C1). A larger valued C1 (up to 3.3 $\mu$ F) improves load regulation and minimizes charge pump output resistance. Beyond 3.3 $\mu$ F, the switch-on resistance dominates the output impedance for capacitor values above 2.2 $\mu$ F.

The output ripple is affected by the value and ESR of the output capacitor (C2). Larger capacitors reduce output ripple on the negative power supply. Lower ESR capacitors minimize the output ripple and reduce the output impedance of the charge pump.

The LM4920 charge pump design is optimized for 2.2 $\mu$ F, low ESR, ceramic, flying, and output capacitors.

#### Input Capacitor Value Selection

Amplifying the lowest audio frequencies requires high value input coupling capacitors ( $C_i$  in Figure 1). A high value capacitor can be expensive and may compromise space efficiency in portable designs. In many cases, however, the speakers used in portable systems, whether internal or external, have little ability to reproduce signals below 150Hz. Applications using speakers with this limited frequency response reap little improvement by using high value input and output capacitors.

Besides affecting system cost and size,  $C_i$  has an effect on the LM4920's click and pop performance. The magnitude of the pop is directly proportional to the input capacitor's size. Thus, pops can be minimized by selecting an input capacitor value that is no higher than necessary to meet the desired -3dB frequency.

As shown in Figure 1, the internal input resistor,  $R_i$  and the input capacitor,  $C_i$ , produce a -3dB high pass filter cutoff frequency that is found using Equation (3). Conventional headphone amplifiers require output capacitors; Equation (3) can be used, along with the value of  $R_L$ , to determine towards the value of output capacitor needed to produce a -3dB high pass filter cutoff frequency.

$$f_{i-3dB} = 1 / 2\pi R_i C_i \quad (3)$$

Also, careful consideration must be taken in selecting a certain type of capacitor to be used in the system. Different types of capacitors (tantalum, electrolytic, ceramic) have unique performance characteristics and may affect overall system performance. (See the section entitled Charge Pump Capacitor Selection.)

**Application Information** (Continued)

**LM4920 micro SMD DEMO BOARD ARTWORK**

Top Layer

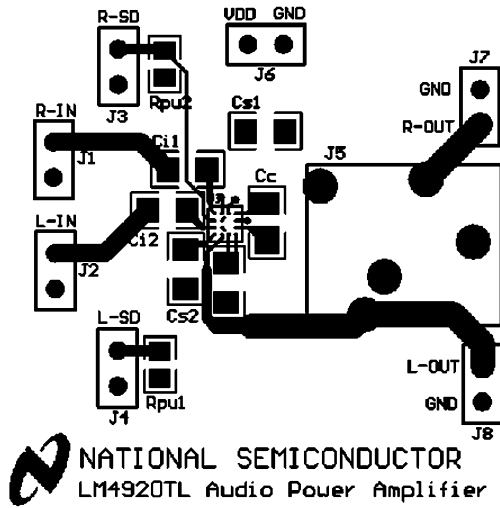

20179305

Mid Layer 1

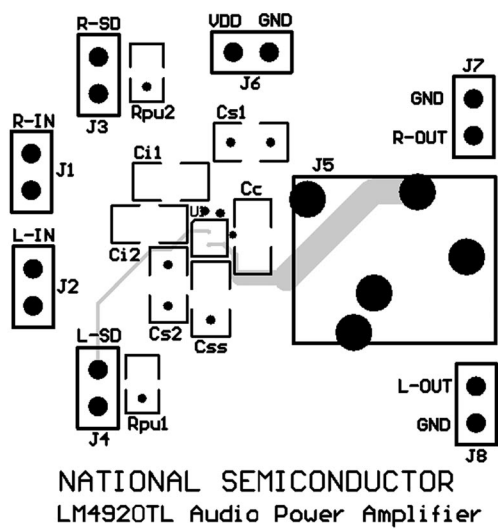

20179306

Mid Layer 2

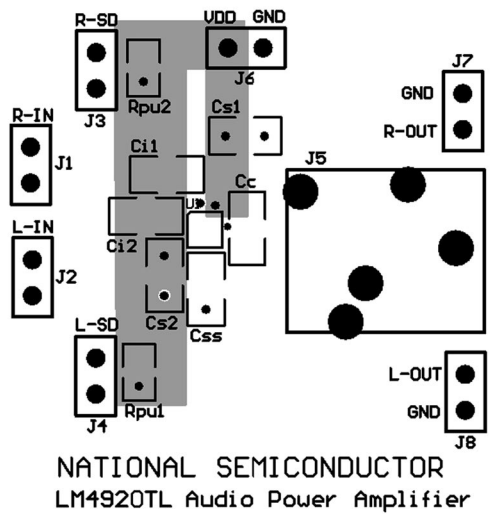

20179307

Bottom Layer

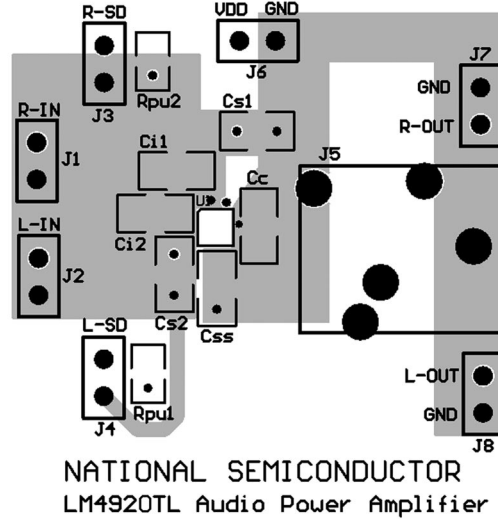

20179308

## Revision History

Rev	Date	Description
1.0	03/27/06	Initial WEB release of the datasheet.



**Physical Dimensions** inches (millimeters) unless otherwise noted

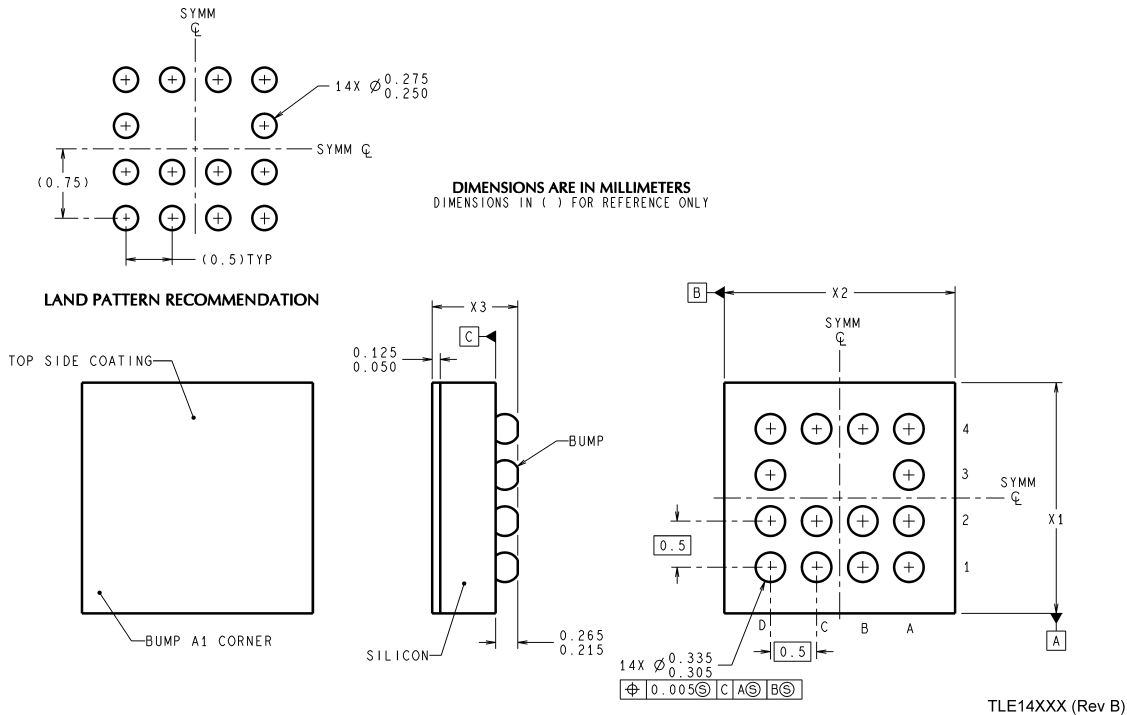

**14 – Bump micro SMD**  
**Order Number LM4920TL**  
**NS Package Number TLE1411A**  
**X1 = 1.970±0.03mm, X2 = 1.970±0.03mm, X3 = 0.600±0.075mm,**

National does not assume any responsibility for use of any circuitry described, no circuit patent licenses are implied and National reserves the right at any time without notice to change said circuitry and specifications.  
 For the most current product information visit us at [www.national.com](http://www.national.com).

**LIFE SUPPORT POLICY**

NATIONAL'S PRODUCTS ARE NOT AUTHORIZED FOR USE AS CRITICAL COMPONENTS IN LIFE SUPPORT DEVICES OR SYSTEMS WITHOUT THE EXPRESS WRITTEN APPROVAL OF THE PRESIDENT AND GENERAL COUNSEL OF NATIONAL SEMICONDUCTOR CORPORATION. As used herein:

1. Life support devices or systems are devices or systems which, (a) are intended for surgical implant into the body, or (b) support or sustain life, and whose failure to perform when properly used in accordance with instructions for use provided in the labeling, can be reasonably expected to result in a significant injury to the user.
2. A critical component is any component of a life support device or system whose failure to perform can be reasonably expected to cause the failure of the life support device or system, or to affect its safety or effectiveness.

**BANNED SUBSTANCE COMPLIANCE**

National Semiconductor manufactures products and uses packing materials that meet the provisions of the Customer Products Stewardship Specification (CSP-9-111C2) and the Banned Substances and Materials of Interest Specification (CSP-9-111S2) and contain no "Banned Substances" as defined in CSP-9-111S2.  
 Leadfree products are RoHS compliant.

**National Semiconductor**  
**Americas Customer Support Center**  
 Email: [new.feedback@nsc.com](mailto:new.feedback@nsc.com)  
 Tel: 1-800-272-9959

**National Semiconductor**  
**Europe Customer Support Center**  
 Fax: +49 (0) 180-530 85 86  
 Email: [europe.support@nsc.com](mailto:europe.support@nsc.com)  
 Deutsch Tel: +49 (0) 69 9508 6208  
 English Tel: +44 (0) 870 24 0 2171  
 Français Tel: +33 (0) 1 41 91 8790

**National Semiconductor**  
**Asia Pacific Customer Support Center**  
 Email: [ap.support@nsc.com](mailto:ap.support@nsc.com)

**National Semiconductor**  
**Japan Customer Support Center**  
 Fax: 81-3-5639-7507  
 Email: [jpn.feedback@nsc.com](mailto:jpn.feedback@nsc.com)  
 Tel: 81-3-5639-7560