

LM4941 Boomer® Audio Power Amplifier Series

1.25 Watt Fully Differential Audio Power Amplifier With RF Suppression and Shutdown

General Description

The LM4941 is a fully differential audio power amplifier primarily designed for demanding applications in mobile phones and other portable communication device applications. It is capable of delivering 1.25 watts of continuous average power to a 8Ω load with less than 1% distortion (THD+N) from a $5V_{DC}$ power supply. The LM4941 does not require output coupling capacitors or bootstrap capacitors, and therefore is ideally suited for mobile phone and other low voltage applications where minimal power consumption is a primary requirement.

The LM4941 also features proprietary internal circuitry that suppresses the coupling of RF signals into the chip. This is important because certain types of RF signals (such as GSM) can couple into audio amplifiers in such a way that part of the signal is heard through the speaker. The RF suppression circuitry in the LM4941 makes it well-suited for portable applications in which strong RF signals generated by an antenna from or a cellular phone or other portable electronic device may couple audibly into the amplifier.

Other features include a low-power consumption shutdown mode, internal thermal shutdown protection, and advanced pop & click circuitry.

Key Specifications

■ Improved PSRR at 217Hz	95dB (typ)
■ Power Output at 5.0V @ 1% THD (8Ω)	1.25W (typ)
■ Power Output at 3.3V @ 1% THD	550mW (typ)
■ Shutdown Current	0.1 μ A (typ)

Features

- Improved RF suppression, by up to 20dB over previous designs in selected applications
- Fully differential amplification
- Available in space-saving micro SMD package
- Ultra low current shutdown mode
- Can drive capacitive loads up to 100pF
- Improved pop & click circuitry eliminates noises during turn-on and turn-off transitions
- 2.4 - 5.5V operation
- No output coupling capacitors, snubber networks or bootstrap capacitors required

Applications

- Mobile phones
- PDAs
- Portable electronic devices

Typical Application

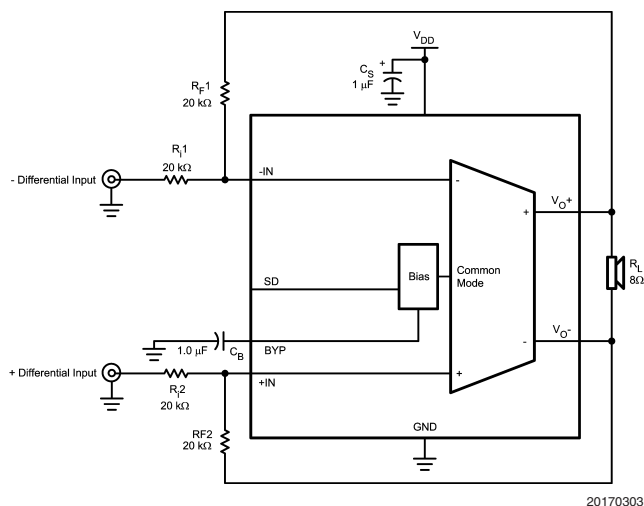
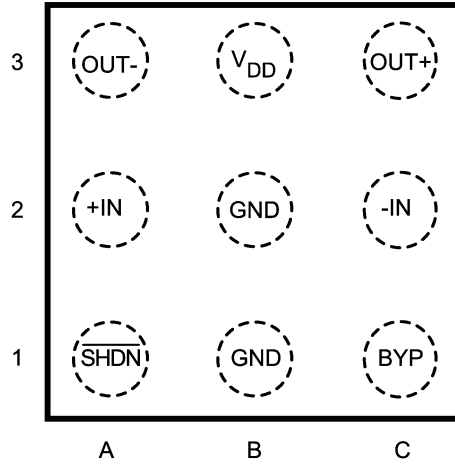

FIGURE 1. Typical Audio Amplifier Application Circuit

Connection Diagrams

9 Bump micro SMD Package



20170304

Top View
Order Number LM4941TM
See NS Package Number TMD09AAA

micro SMD Marking

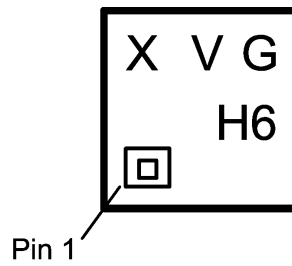

20170302

Top View
X = Date Code
V = Die Traceability
G = Boomer Family
H6 = LM4941TM

Absolute Maximum Ratings (Note 2)

If Military/Aerospace specified devices are required, please contact the National Semiconductor Sales Office/Distributors for availability and specifications.

Supply Voltage	6.0V
Storage Temperature	-65°C to +150°C
Input Voltage	-0.3V to $V_{DD} + 0.3V$
Power Dissipation (Note 3)	Internally Limited
ESD Susceptibility (Note 4)	2000V
ESD Susceptibility (Note 5)	200V
Junction Temperature	150°C

Thermal Resistance

 θ_{JA} (TM)

100°C/W

Soldering Information

See AN-1187

Operating Ratings

Temperature Range

 $T_{MIN} \leq T_A \leq T_{MAX}$ $-40^\circ\text{C} \leq T_A \leq 85^\circ\text{C}$

Supply Voltage

 $2.4V \leq V_{DD} \leq 5.5V$ **Electrical Characteristics $V_{DD} = 5V$** (Notes 1, 2)

The following specifications apply for $V_{DD} = 5V$, $A_V = 1$, and 8Ω load unless otherwise specified. Limits apply for $T_A = 25^\circ\text{C}$.

Symbol	Parameter	Conditions	LM4941		Units (Limits)
			Typical	Limit	
			(Note 6)	(Note 7)	
I_{DD}	Quiescent Power Supply Current	$V_{IN} = 0V$, no load $V_{IN} = 0V$, $R_L = 8\Omega$	1.7 1.7	2.5	mA (max)
I_{SD}	Shutdown Current	$V_{SHUTDOWN} = GND$	0.1	1	μA (max)
P_o	Output Power	THD = 1% (max); $f = 1\text{ kHz}$ $R_L = 8\Omega$	1.25	1.1	W (min)
		THD = 10% (max); $f = 1\text{ kHz}$ $R_L = 8\Omega$	1.54		W
THD+N	Total Harmonic Distortion + Noise	$P_o = .7\text{ Wrms}$; $f = 1\text{ kHz}$.04		%
PSRR	Power Supply Rejection Ratio	$V_{ripple} = 200\text{mV}$ sine p-p $f = 217\text{Hz}$ (Note 8)	95	70	dB (min)
		$f = 1\text{ kHz}$ (Note 8)	90		
		$f = 217\text{Hz}$, $V_{CM} = 200\text{mV}_{pp}$ $f = 20\text{Hz}-20\text{kHz}$, $V_{CM} = 200\text{mV}_{pp}$	70		
CMRR	Common-Mode Rejection Ratio	$f = 217\text{Hz}$, $V_{CM} = 200\text{mV}_{pp}$ $f = 20\text{Hz}-20\text{kHz}$, $V_{CM} = 200\text{mV}_{pp}$	70		dB dB
V_{OS}	Output Offset	$V_{IN} = 0V$	2		mV
V_{SDIH}	Shutdown Voltage Input High			1.4	V (min)
V_{SDIL}	Shutdown Voltage Input Low			0.4	V (max)
SNR	Signal-to-Noise Ratio	$P_o = 1W$, $f = 1\text{ kHz}$	108		dB
T_{WU}	Wake-up Time from Shutdown	$C_{bypass} = 1\mu\text{F}$	12		ms

Electrical Characteristics $V_{DD} = 3V$ (Notes 1, 2)

The following specifications apply for $V_{DD} = 3V$, $A_V = 1$, and 8Ω load unless otherwise specified. Limits apply for $T_A = 25^\circ\text{C}$.

Symbol	Parameter	Conditions	LM4941		Units (Limits)
			Typical	Limit	
			(Note 6)	(Note 7)	
I_{DD}	Quiescent Power Supply Current	$V_{IN} = 0V$, no load $V_{IN} = 0V$, $R_L = 8\Omega$	1.6 1.6	2.4	mA (max)
I_{SD}	Shutdown Current	$V_{SHUTDOWN} = GND$	0.1	1	μA (max)
P_o	Output Power	THD = 1% (max); $f = 1\text{ kHz}$ $R_L = 8\Omega$	0.43		W
		THD = 10% (max); $f = 1\text{ kHz}$ $R_L = 8\Omega$	0.54		W
THD+N	Total Harmonic Distortion + Noise	$P_o = 0.25\text{Wrms}$; $f = 1\text{ kHz}$.05		%
PSRR	Power Supply Rejection Ratio	$V_{ripple} = 200\text{mV}$ sine p-p $f = 217\text{Hz}$ (Note 8)	95		dB
		$f = 1\text{ kHz}$ (Note 8)	90		
		$f = 217\text{Hz}$, $V_{CM} = 200\text{mV}_{pp}$ $f = 20\text{Hz}-20\text{kHz}$, $V_{CM} = 200\text{mV}_{pp}$	70		

Electrical Characteristics $V_{DD} = 3V$ (Notes 1, 2)

The following specifications apply for $V_{DD} = 3V$, $A_V = 1$, and 8Ω load unless otherwise specified. Limits apply for $T_A = 25^\circ C$. (Continued)

Symbol	Parameter	Conditions	LM4941		Units (Limits)
			Typical	Limit	
			(Note 6)	(Note 7)	
CMRR	Common-Mode Rejection Ratio	$f = 217\text{Hz}$, $V_{CM} = 200\text{mV}_{pp}$	70		dB
V_{OS}	Output Offset	$V_{IN} = 0V$	2		mV (max)
V_{SDIH}	Shutdown Voltage Input High			1.4	V (min)
V_{SDIL}	Shutdown Voltage Input Low			0.4	V (max)
T_{WU}	Wake-up Time from Shutdown	Cbypass	8		ms

Note 1: All voltages are measured with respect to the ground pin, unless otherwise specified.

Note 2: *Absolute Maximum Ratings* indicate limits beyond which damage to the device may occur. *Operating Ratings* indicate conditions for which the device is functional, but do not guarantee specific performance limits. *Electrical Characteristics* state DC and AC electrical specifications under particular test conditions which guarantee specific performance limits. This assumes that the device is within the Operating Ratings. Specifications are not guaranteed for parameters where no limit is given, however, the typical value is a good indication of device performance.

Note 3: The maximum power dissipation must be derated at elevated temperatures and is dictated by T_{JMAX} , θ_{JA} , and the ambient temperature T_A . The maximum allowable power dissipation is $P_{DMAX} = (T_{JMAX} - T_A) / \theta_{JA}$ or the number given in Absolute Maximum Ratings, whichever is lower. For the LM4941, see power derating curve for additional information.

Note 4: Human body model, 100pF discharged through a 1.5k Ω resistor.

Note 5: Machine Model, 220pF – 240pF discharged through all pins.

Note 6: Typicals are measured at 25°C and represent the parametric norm.

Note 7: Limits are guaranteed to National's AOQL (Average Outgoing Quality Level).

Note 8: 10 Ω terminated input.

Note 9: Data taken with BW = 80kHz and $A_V = 1/1$ except where specified.

External Components Description

(Figure 1)

Components		Functional Description
1.	C_S	Supply bypass capacitor which provides power supply filtering. Refer to the Power Supply Bypassing section for information concerning proper placement and selection of the supply bypass capacitor.
2.	C_B	Bypass pin capacitor which provides half-supply filtering. Refer to the section, Proper Selection of External Components , for information concerning proper placement and selection of C_B .
3.	R_i	Inverting input resistance which sets the closed-loop gain in conjunction with R_f .
4.	R_f	Internal feedback resistance which sets the closed-loop gain in conjunction with R_i .

Typical Performance Characteristics (Note 9)

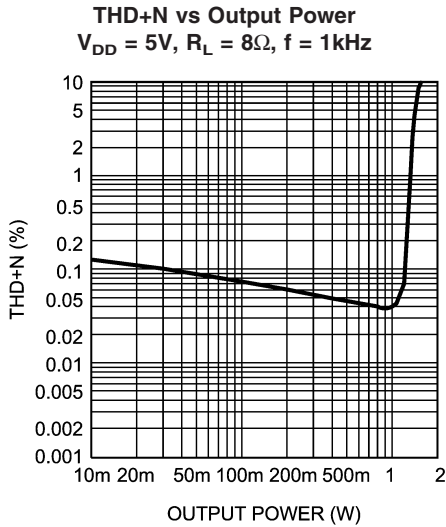

20170305

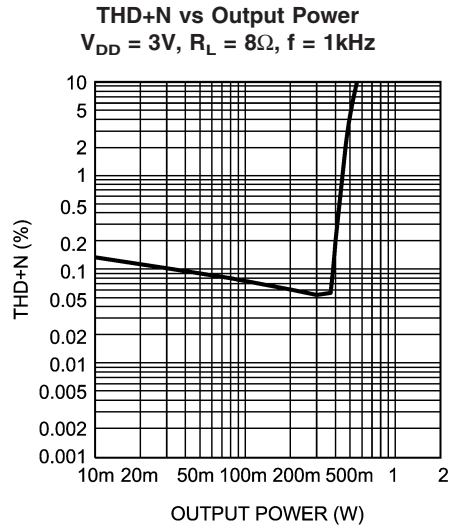

20170306

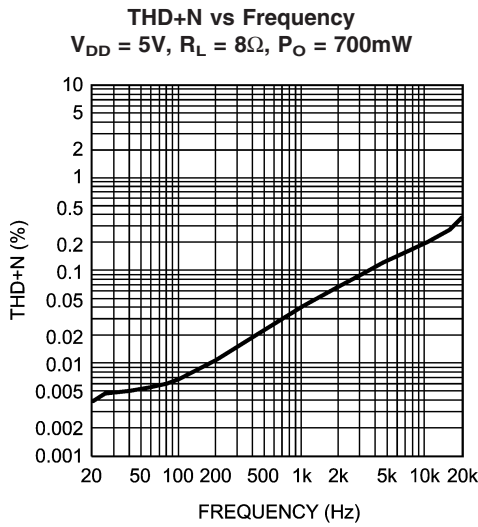

20170307

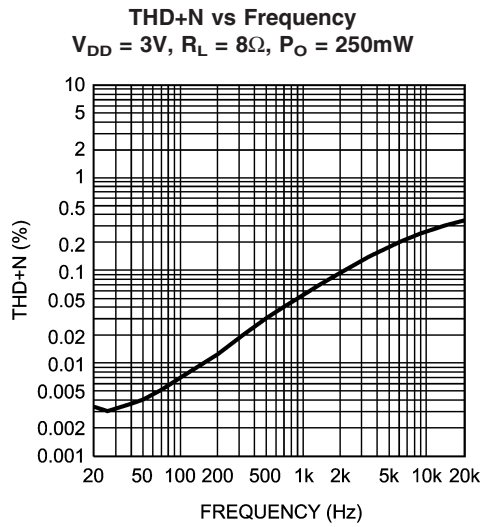

20170308

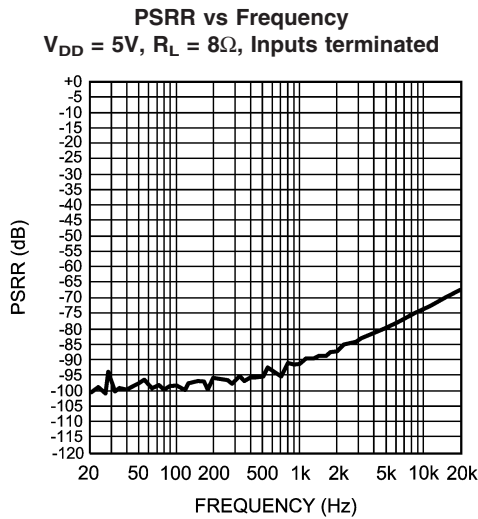

20170309

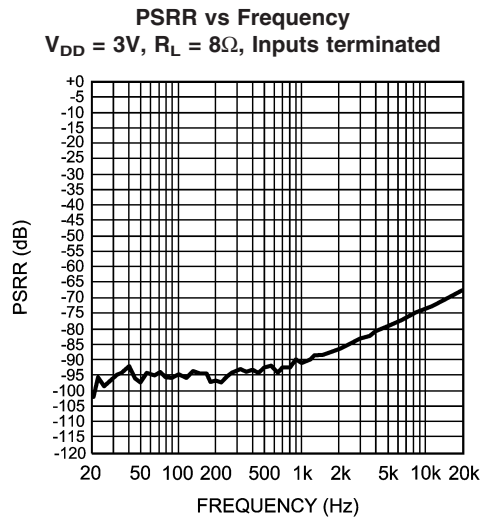

20170310

Typical Performance Characteristics (Note 9) (Continued)

CMRR vs Frequency
 $V_{DD} = 5V, R_L = 8\Omega$

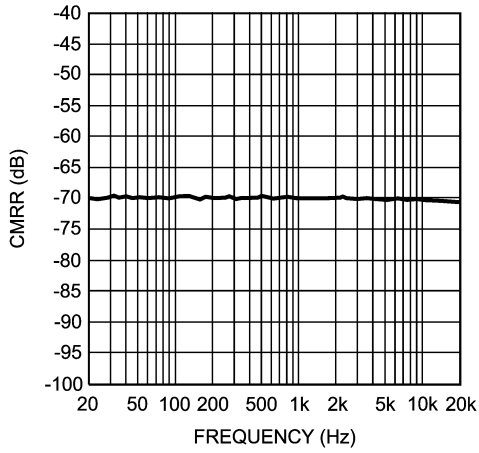

20170311

CMRR vs Frequency
 $V_{DD} = 3V, R_L = 8\Omega$

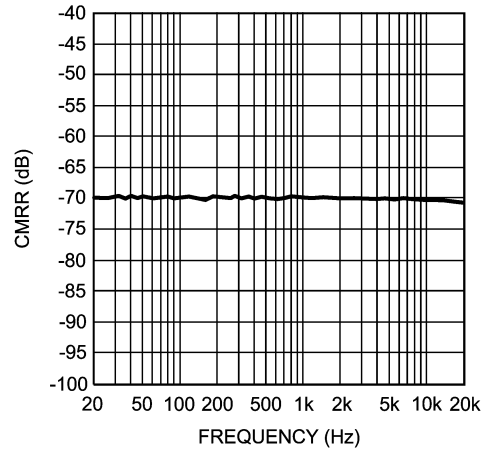

20170312

PSRR vs Common Mode Voltage
 $V_{DD} = 5V, R_L = 8\Omega, f = 217Hz$

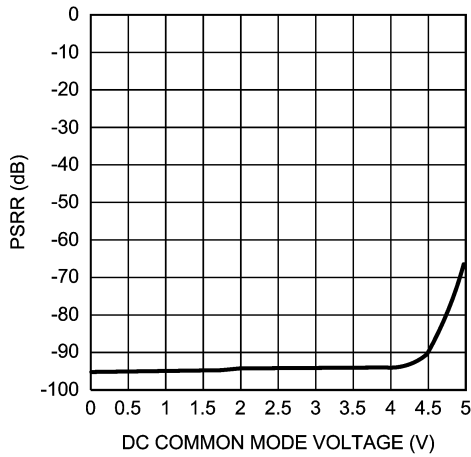

20170323

PSRR vs Common Mode Voltage
 $V_{DD} = 3V, R_L = 8\Omega, f = 217Hz$

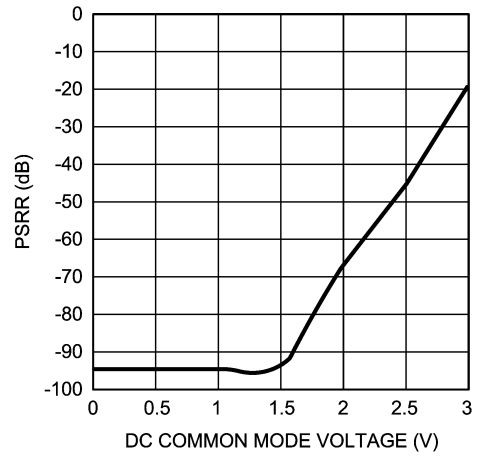

20170324

Power Dissipation vs Output Power
 $V_{DD} = 5V, R_L = 8\Omega$

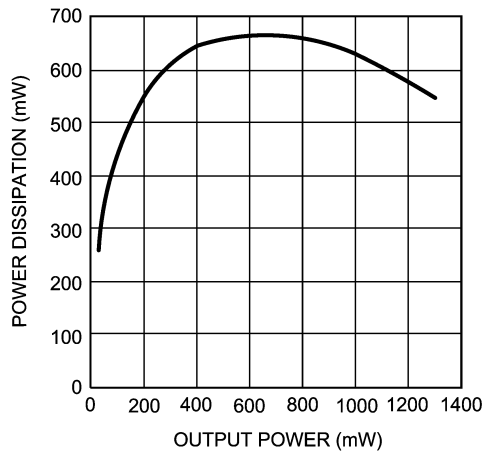

20170315

Power Dissipation vs Output Power
 $V_{DD} = 3V, R_L = 8\Omega$

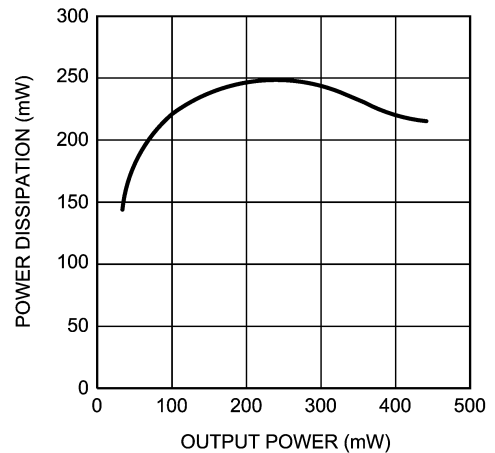

20170316

Typical Performance Characteristics (Note 9) (Continued)

Output Power vs Supply Voltage
 $R_L = 8\Omega$, Top-THD+N = 10%; Bot-THD+N = 1%

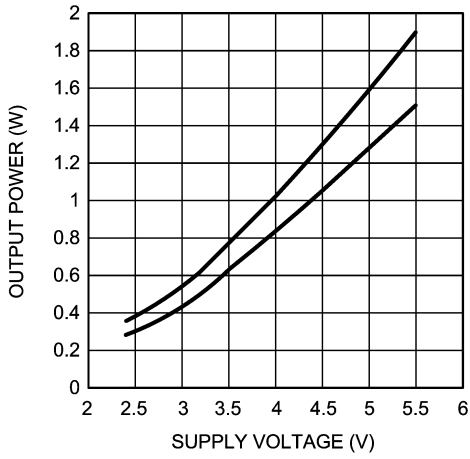

20170317

Clipping Voltage vs Supply Voltage

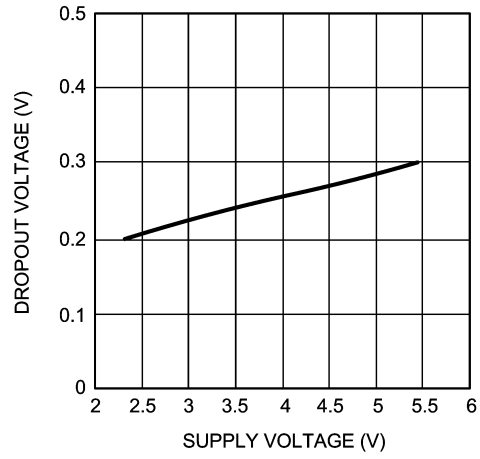

20170318

Output Power vs Load Resistance
 Top- $V_{DD} = 5V$, 10% THD+N, Topmid- $V_{DD} = 5V$, 1% THD+N
 Bot- $V_{DD} = 3V$, 10% THD+N, Botmid- $V_{DD} = 3V$, 1% THD+N

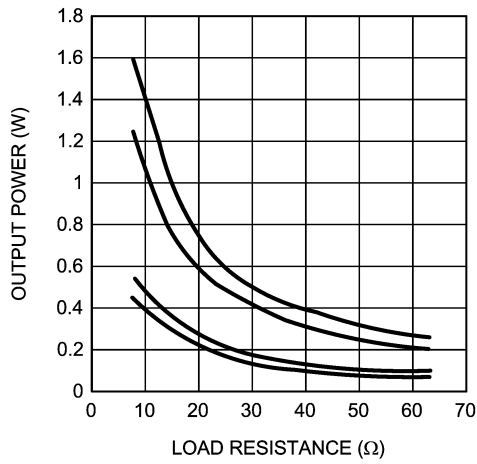

20170319

Application Information

OPTIMIZING RF IMMUNITY

The internal circuitry of the LM4941 suppresses the amount of RF signal that is coupled into the chip. However, certain external factors, such as output trace length, output trace orientation, distance between the chip and the antenna, antenna strength, speaker type, and type of RF signal, may affect the RF immunity of the LM4941. In general, the RF immunity of the LM4941 is application specific. Nevertheless, optimal RF immunity can be achieved by using short output traces and increasing the distance between the LM4941 and the antenna.

DIFFERENTIAL AMPLIFIER EXPLANATION

The LM4941 is a fully differential audio amplifier that features differential input and output stages. Internally this is accomplished by two circuits: a differential amplifier and a common mode feedback amplifier that adjusts the output voltages so that the average value remains $V_{DD} / 2$. When setting the differential gain, the amplifier can be considered to have "halves". Each half uses an input and feedback resistor (R_{i1} and R_{F1}) to set its respective closed-loop gain (see Figure 1). With $R_{i1} = R_{i2}$ and $R_{F1} = R_{F2}$, the gain is set at $-R_F / R_i$ for each half. This results in a differential gain of

$$A_{VD} = -R_F/R_i \quad (1)$$

It is extremely important to match the input resistors to each other, as well as the feedback resistors to each other for best amplifier performance. See the **Proper Selection of External Components** section for more information. A differential amplifier works in a manner where the difference between the two input signals is amplified. In most applications, input signals will be 180° out of phase with each other. The LM4941 can be used, however, as a single ended input amplifier while still retaining its fully differential benefits because it simply amplifies the difference between the inputs.

All of these applications provide what is known as a "bridged mode" output (bridge-tied-load, BTL). This results in output signals at V_{o1} and V_{o2} that are 180° out of phase with respect to each other. Bridged mode operation is different from the single-ended amplifier configuration that connects the load between the amplifier output and ground. A bridged amplifier design has distinct advantages over the single-ended configuration: it provides differential drive to the load, thus doubling maximum possible output swing for a specific supply voltage. Four times the output power is possible compared with a single-ended amplifier under the same conditions. This increase in attainable output power assumes that the amplifier is not current limited or clipped. In order to choose an amplifier's closed-loop gain without causing excess clipping, please refer to the **Audio Power Amplifier Design** section.

A bridged configuration, such as the one used in the LM4941, also creates a second advantage over single-ended amplifiers. Since the differential outputs, V_{o1} and V_{o2} , are biased at half-supply, no net DC voltage exists across the load. This assumes that the input resistor pair and the feedback resistor pair are properly matched (see **Proper Selection of External Components**). BTL configuration eliminates the output coupling capacitor required in single-supply, single-ended amplifier configurations. If an output

coupling capacitor is not used in a single-ended output configuration, the half-supply bias across the load would result in both increased internal IC power dissipation as well as permanent loudspeaker damage. Further advantages of bridged mode operation specific to fully differential amplifiers like the LM4941 include increased power supply rejection ratio, common-mode noise reduction, and click and pop reduction.

POWER DISSIPATION

Power dissipation is a major concern when designing a successful amplifier, whether the amplifier is bridged or single-ended. Equation 2 states the maximum power dissipation point for a single-ended amplifier operating at a given supply voltage and driving a specified output load.

$$P_{DMAX} = (V_{DD})^2 / (2\pi^2 R_L) \text{ Single-Ended} \quad (2)$$

However, a direct consequence of the increased power delivered to the load by a bridge amplifier is an increase in internal power dissipation versus a single-ended amplifier operating at the same conditions.

$$P_{DMAX} = 4 * (V_{DD})^2 / (2\pi^2 R_L) \text{ Bridge Mode} \quad (3)$$

Since the LM4941 has bridged outputs, the maximum internal power dissipation is 4 times that of a single-ended amplifier. Even with this substantial increase in power dissipation, the LM4941 does not require additional heatsinking under most operating conditions and output loading. From Equation 3, assuming a 5V power supply and an 8Ω load, the maximum power dissipation point is 625mW. The maximum power dissipation point obtained from Equation 3 must not be greater than the power dissipation results from Equation 4:

$$P_{DMAX} = (T_{JMAX} - T_A) / \theta_{JA} \quad (4)$$

The LM4941's θ_{JA} in a TMD09XXX package is 100°C/W. Depending on the ambient temperature, T_A , of the system surroundings, Equation 4 can be used to find the maximum internal power dissipation supported by the IC packaging. If the result of Equation 3 is greater than that of Equation 4, then either the supply voltage must be decreased, the load impedance increased, the ambient temperature reduced, or the θ_{JA} reduced with heatsinking. In many cases, larger traces near the output, V_{DD} , and GND pins can be used to lower the θ_{JA} . The larger areas of copper provide a form of heatsinking allowing higher power dissipation. For the typical application of a 5V power supply, with an 8Ω load, the maximum ambient temperature possible without violating the maximum junction temperature is approximately 110°C provided that device operation is around the maximum power dissipation point. Recall that internal power dissipation is a function of output power. If typical operation is not around the maximum power dissipation point, the LM4941 can operate at higher ambient temperatures. Refer to the **Typical Performance Characteristics** curves for power dissipation information.

POWER SUPPLY BYPASSING

As with any power amplifier, proper supply bypassing is critical for low noise performance and high power supply rejection ratio (PSRR). The capacitor location on both the bypass and power supply pins should be as close to the

Application Information (Continued)

device as possible. Typical applications employ a 5V regulator with 10 μ F and 0.1 μ F bypass capacitors that increase supply stability. This, however, does not eliminate the need for bypassing the supply nodes of the LM4941. The LM4941 will operate without the bypass capacitor C_B , although the PSRR may decrease. A 1 μ F capacitor is recommended for C_B . This value maximizes PSRR performance. Lesser values may be used, but PSRR decreases at frequencies below 1kHz. The issue of C_B selection is thus dependant upon desired PSRR and click and pop performance as explained in the section **Proper Selection of External Components**.

SHUTDOWN FUNCTION

In order to reduce power consumption while not in use, the LM4941 contains shutdown circuitry that is used to turn off the amplifier's bias circuitry. The device may then be placed into shutdown mode by toggling the Shutdown Select pin to logic low. The trigger point for shutdown is shown as a typical value in the Supply Current vs Shutdown Voltage graphs in the **Typical Performance Characteristics** section. It is best to switch between ground and supply for maximum performance. While the device may be disabled with shutdown voltages in between ground and supply, the idle current may be greater than the typical value of 0.1 μ A. In either case, the shutdown pin should be tied to a definite voltage to avoid unwanted state changes.

In many applications, a microcontroller or microprocessor output is used to control the shutdown circuitry, which provides a quick, smooth transition to shutdown. Another solution is to use a single-throw switch in conjunction with an external pull-up resistor. This scheme guarantees that the shutdown pin will not float, thus preventing unwanted state changes.

PROPER SELECTION OF EXTERNAL COMPONENTS

Proper selection of external components in applications using integrated power amplifiers is critical when optimizing device and system performance. Although the LM4941 is tolerant to a variety of external component combinations, consideration of component values must be made when maximizing overall system quality.

The LM4941 is unity-gain stable, giving the designer maximum system flexibility. The LM4941 should be used in low closed-loop gain configurations to minimize THD+N values and maximize signal to noise ratio. Low gain configurations require large input signals to obtain a given output power. Input signals equal to or greater than 1Vrms are available from sources such as audio codecs. Please refer to the Audio Power Amplifier Design section for a more complete explanation of proper gain selection. When used in its typical application as a fully differential power amplifier the LM4941 does not require input coupling capacitors for input sources with DC common-mode voltages of less than V_{DD} . Exact allowable input common-mode voltage levels are actually a function of V_{DD} , R_i , and R_f and may be determined by Equation 5:

$$V_{CMI} < (V_{DD}-1.2) * ((R_f + (R_i)/(R_f)) - V_{DD} * (R_i / 2R_f)) \quad (5)$$

$$-R_f / R_i = A_{VD} \quad (6)$$

When using DC coupled inputs, special care must be taken to match the values of the input resistors (R_{i1} and R_{i2}) to each other. Because of the balanced nature of differential amplifiers, resistor matching differences can result in net DC currents across the load. This DC current can increase power consumption, internal IC power dissipation, reduce PSRR, and possibly damaging the loudspeaker. The chart below demonstrates this problem by showing the effects of differing values between the feedback resistors while assuming that the input resistors are perfectly matched. The results below apply to the application circuit shown in Figure 1, and assumes that $V_{DD} = 5V$, $R_L = 8\Omega$, and the system has DC coupled inputs tied to ground.

Tolerance	R_{i1}	R_{i2}	$V_{O2} - V_{O1}$	I_{LOAD}
20%	0.8R	1.2R	-0.500V	62.5mA
10%	0.9R	1.1R	-0.250V	31.25mA
5%	0.95R	1.05R	-0.125V	15.63mA
1%	0.99R	1.01R	-0.025V	3.125mA
0%	R	R	0	0

Since the same variations can have a significant effect on PSRR and CMRR performance, it is highly recommended that the input resistors be matched to 1% tolerance or better for best performance.

AUDIO POWER AMPLIFIER DESIGN

Design a 1W/8 Ω Audio Amplifier

Given:

Power Output	1Wrms
Load Impedance	8 Ω
Input Level	1Vrms
Input Impedance	20k Ω
Bandwidth	100Hz–20kHz \pm 0.25dB

A designer must first determine the minimum supply rail to obtain the specified output power. The supply rail can easily be found by extrapolating from the Output Power vs Supply Voltage graphs in the **Typical Performance Characteristics** section. A second way to determine the minimum supply rail is to calculate the required V_{OPEAK} using Equation 7 and add the dropout voltages. Using this method, the minimum supply voltage is ($V_{OPEAK} + (V_{DO_TOP} + (V_{DO_BOT}))$), where V_{DO_BOT} and V_{DO_TOP} are extrapolated from the Dropout Voltage vs Supply Voltage curve in the **Typical Performance Characteristics** section.

$$V_{OPEAK} = \sqrt{(2R_L P_O)} \quad (7)$$

Using the Output Power vs Supply Voltage graph for an 8 Ω load, the minimum supply rail just about 5V. Extra supply voltage creates headroom that allows the LM4941 to reproduce peaks in excess of 1W without producing audible distortion. At this time, the designer must make sure that the power supply choice along with the output impedance does not violate the conditions explained in the **Power Dissipation** section. Once the power dissipation equations have been addressed, the required differential gain can be determined from Equation 8.

Application Information (Continued)

$$A_{VD} \geq \sqrt{(P_0 R_L)} / (V_{IN}) = V_{or\,ms} / V_{in\,rms} \quad (8)$$

$$R_f / R_i = A_{VD}$$

From Equation 7, the minimum A_{VD} is 2.83. A ratio of R_f to R_i of 2.83 gives $R_i = 14\text{k}\Omega$. The final design step is to address the bandwidth requirement which must be stated as a single -3dB frequency point. Five times away from a -3dB point is 0.17dB down from passband response which is better than the required $\pm 0.25\text{dB}$ specified.

$$f_H = 20\text{kHz} * 5 = 100\text{kHz}$$

The high frequency pole is determined by the product of the desired frequency pole, f_H , and the differential gain, A_{VD} . With a $A_{VD} = 2.83$ and $f_H = 100\text{kHz}$, the resulting GBWP = 150kHz which is much smaller than the LM4941 GBWP of 10MHz . This figure displays that if a designer has a need to design an amplifier with a higher differential gain, the LM4941 can still be used without running into bandwidth limitations.

Recommended TM Board Layout

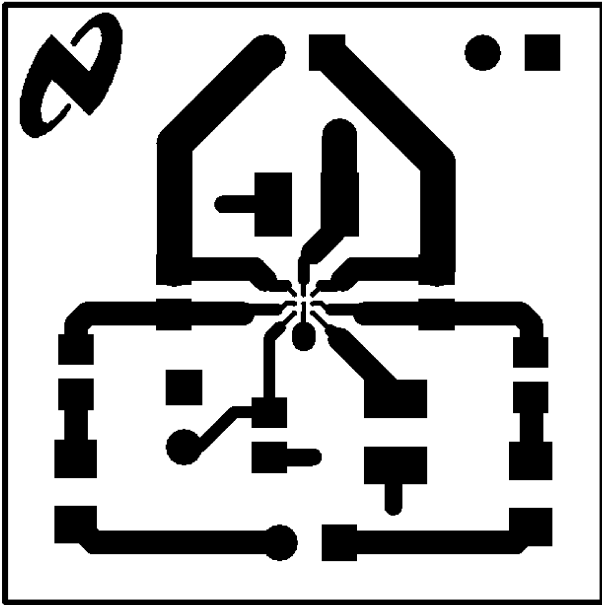

Recommended TM Board Layout: Top Layer

20170321

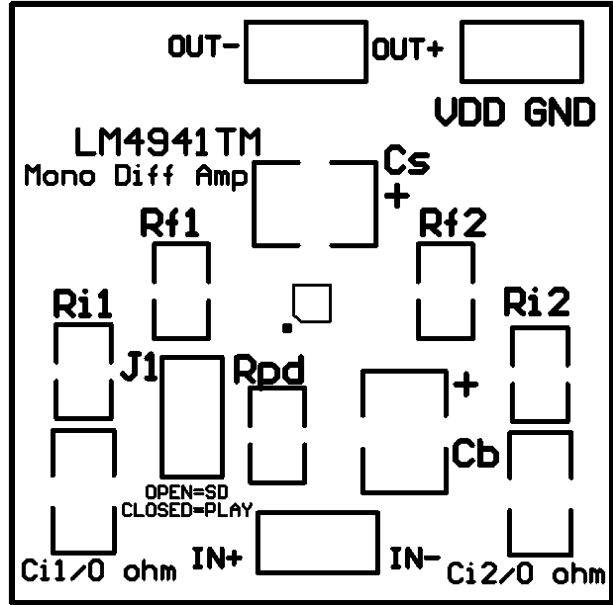

Recommended TM Board Layout: Top Overlay

20170322

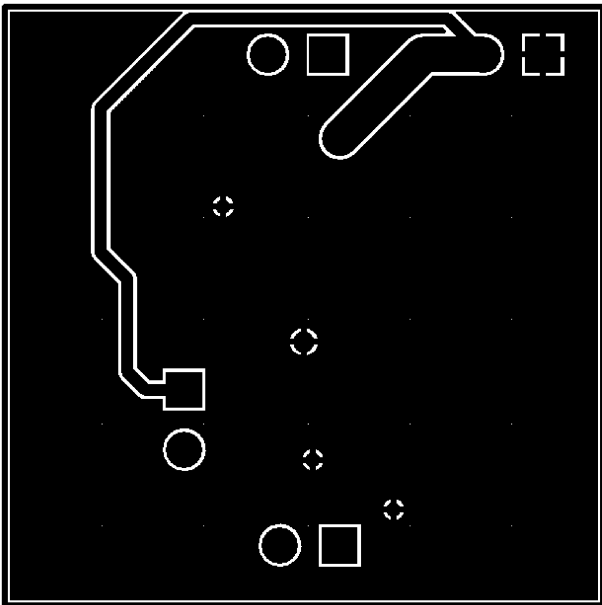

Recommended TM Board Layout: Bottom Layer

20170320

Revision History

Rev	Date	Description
1.0	06/28/06	Initial WEB release.

Physical Dimensions inches (millimeters) unless otherwise noted

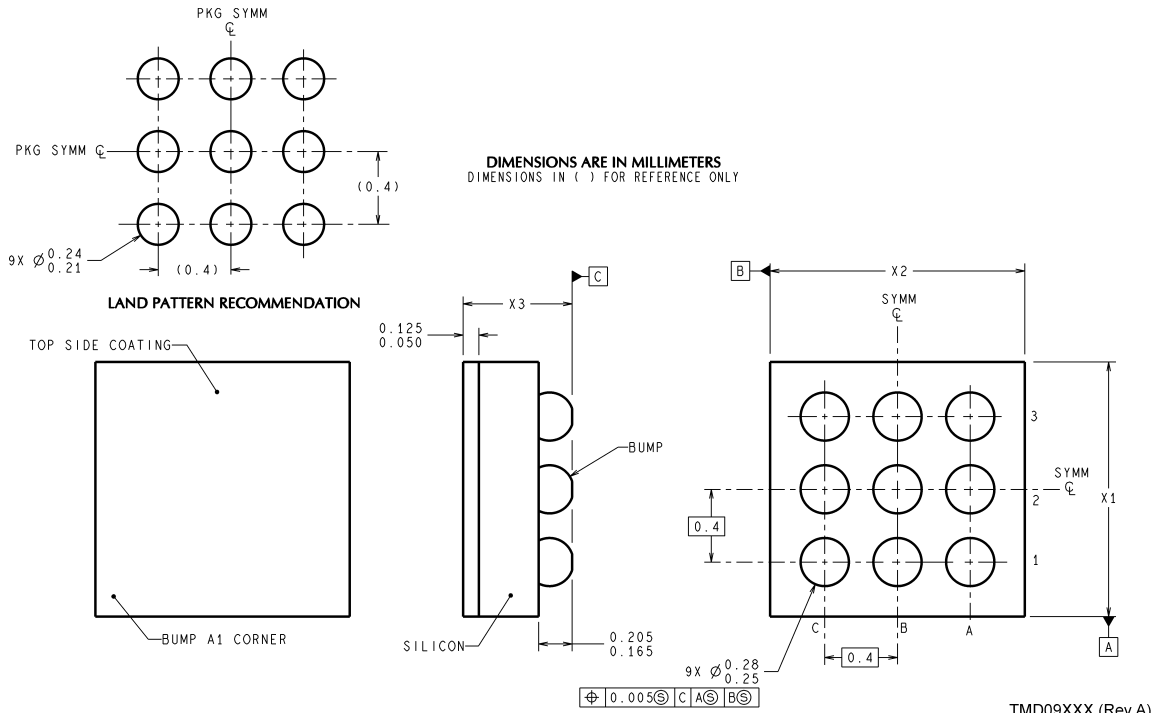

micro SMD Package
Order Number LM4941TM
NS Package Number TMD09AAA
X1 = 1.25mm X2 = 1.25mm X3 = 0.6mm

National does not assume any responsibility for use of any circuitry described, no circuit patent licenses are implied and National reserves the right at any time without notice to change said circuitry and specifications.
 For the most current product information visit us at www.national.com.

LIFE SUPPORT POLICY

NATIONAL'S PRODUCTS ARE NOT AUTHORIZED FOR USE AS CRITICAL COMPONENTS IN LIFE SUPPORT DEVICES OR SYSTEMS WITHOUT THE EXPRESS WRITTEN APPROVAL OF THE PRESIDENT AND GENERAL COUNSEL OF NATIONAL SEMICONDUCTOR CORPORATION. As used herein:

1. Life support devices or systems are devices or systems which, (a) are intended for surgical implant into the body, or (b) support or sustain life, and whose failure to perform when properly used in accordance with instructions for use provided in the labeling, can be reasonably expected to result in a significant injury to the user.
2. A critical component is any component of a life support device or system whose failure to perform can be reasonably expected to cause the failure of the life support device or system, or to affect its safety or effectiveness.

BANNED SUBSTANCE COMPLIANCE

National Semiconductor follows the provisions of the Product Stewardship Guide for Customers (CSP-9-111C2) and Banned Substances and Materials of Interest Specification (CSP-9-111S2) for regulatory environmental compliance. Details may be found at: www.national.com/quality/green.

Lead free products are RoHS compliant.



National Semiconductor
Americas Customer Support Center
 Email: new.feedback@nsc.com
 Tel: 1-800-272-9959

National Semiconductor
Europe Customer Support Center
 Fax: +49 (0) 180-530 85 86
 Email: europe.support@nsc.com
 Deutsch Tel: +49 (0) 69 9508 6208
 English Tel: +44 (0) 870 24 0 2171
 Français Tel: +33 (0) 1 41 91 8790

National Semiconductor
Asia Pacific Customer Support Center
 Email: ap.support@nsc.com

National Semiconductor
Japan Customer Support Center
 Fax: 81-3-5639-7507
 Email: jpn.feedback@nsc.com
 Tel: 81-3-5639-7560