



LM4949 Boomer® Audio Power Amplifier Series

Stereo Class D Audio Subsystem with OCL Headphone Amplifier

General Description

The LM4949 is a fully integrated audio subsystem designed for stereo cell phone applications. The LM4949 combines a 2.5W stereo Class D amplifier plus a separate 190mW stereo headphone amplifier, volume control, and input mixer into a single device. The filterless class D amplifiers deliver 1.19W/channel into an 8Ω load with <1% THD+N from a 5V supply. The headphone amplifier features National's Output Capacitor-less (OCL) architecture that eliminates the output coupling capacitors required by traditional headphone amplifiers. Additionally, the headphone amplifiers can be configured with capacitively coupled (CC) loads, or used to drive an external headphone amplifier. When configured for an external amplifier, the $V_{DD}/2$ output (VOC) controls the external amplifier's shutdown input.

For improved noise immunity, the LM4949 features fully differential left, right and mono inputs. The three inputs can be mixed/multiplexed to either the speaker or headphone amplifiers. The left and right inputs can be used as separate single-ended inputs, mixing multiple stereo audio sources. The mixer, volume control, and device mode select are controlled through an I²C compatible interface.

Output short circuit and thermal shutdown protection prevent the device from being damaged during fault conditions. Superior click and pop suppression eliminates audible transients on power-up/down and during shutdown.

Key Specifications

■ Efficiency $V_{DD} = 3.6V$, 400mW into 8Ω	86.5%
■ Efficiency $V_{DD} = 5V$, 1W into 8Ω	87.4%
■ Quiescent Power Supply Current @ 3.6V	9.36mA
■ Power Output at $V_{DD} = 5V$	
Speaker:	
$R_L = 4\Omega$, THD+N ≤ 1%	2W
$R_L = 8\Omega$, THD+N ≤ 1%	1.19W
$R_L = 4\Omega$, THD+N ≤ 10%	2.5W
Headphone:	
$R_L = 16\Omega$, THD+N ≤ 1%	153mW
$R_L = 32\Omega$, THD+N ≤ 1%	89mW
■ Shutdown Current	0.1μA

Features

- Output Short Circuit Protection
- Thermal Shutdown
- Stereo filterless Class D operation
- Selectable OCL/CC Headphone Drivers
- RF Suppression
- I²C Control Interface
- 32-step digital volume control
- Independent Speaker and Headphone Gain Settings
- Minimum external components
- Click and Pop suppression
- Micro-power shutdown
- Available in space-saving 25 bump μSMD package

Applications

- Mobile phones
- PDAs
- Laptops

Typical Application

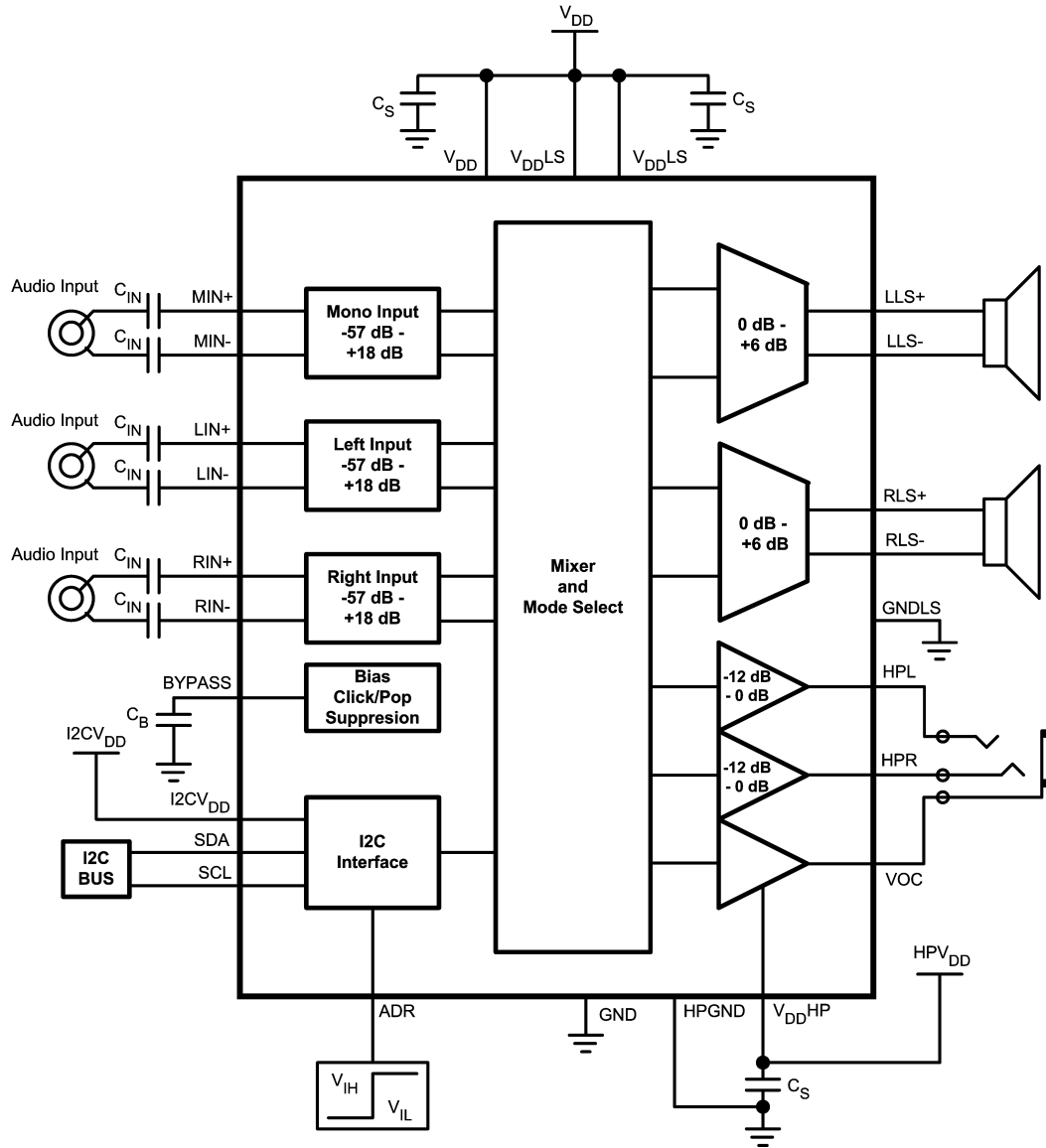

202001C6

FIGURE 1. Typical Audio Amplifier Application Circuit

Connection Diagrams

TL Package
2.68mm x 2.68mm x 0.6mm

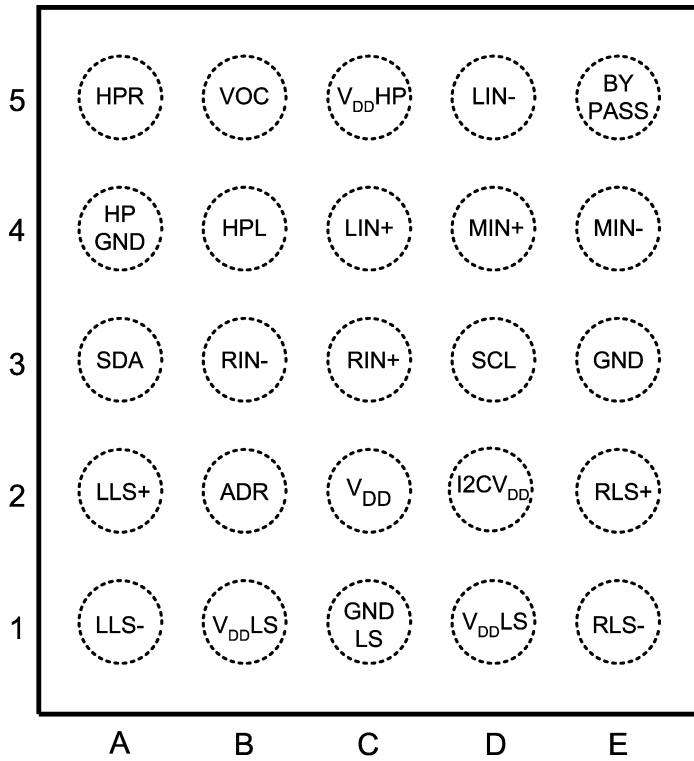

202001C7

Top View
Order Number LM4949TL
See NS Package Number TLA25JJA

LM4949TL Marking

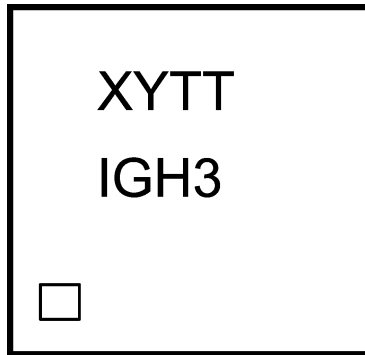

202001C0

Top View
XY — 2 digit datecode
TT — Die traceability

Absolute Maximum Ratings (Note 2)

If Military/Aerospace specified devices are required, please contact the National Semiconductor Sales Office/Distributors for availability and specifications.

Supply Voltage (Note 1)	6.0V
Storage Temperature	-65°C to +150°C
Input Voltage	-0.3V to $V_{DD} + 0.3V$
Power Dissipation (Note 3)	Internally Limited
ESD Susceptibility (Note 4)	2000V
ESD Susceptibility (Note 5)	200V
Junction Temperature	150°C

Thermal Resistance

 θ_{JA}

35.1°C/W

Operating Ratings

Temperature Range

 $T_{MIN} \leq T_A \leq T_{MAX}$ $-40^\circ\text{C} \leq T_A \leq +85^\circ\text{C}$ Supply Voltage (V_{DD} , V_{DDLS} , V_{DDHP}) $2.7V \leq V_{DD} \leq 5.5V$ I²C Voltage (I²CV_{DD}) $2.4V \leq I^2CV_{DD} \leq 5.5V$ **Electrical Characteristics $V_{DD} = 3.0V$** (Notes 1, 2)

The following specifications apply for $A_V = 0\text{dB}$, $R_{L(SP)} = 15\mu\text{H} + 8\Omega + 15\mu\text{H}$, $R_{L(HP)} = 32\Omega$, $f = 1\text{kHz}$ unless otherwise specified. Limits apply for $T_A = 25^\circ\text{C}$.

Symbol	Parameter	Conditions	LM4949		Units (Limits)
			Typical	Limit	
			(Note 6)	(Notes 7, 8)	
I_{DD}	Supply Current	LS Mode			
		Stereo	6	8.75	mA (max)
		Mono	4.5		mA
		OCL HP Mode			
		Stereo	5.0	6.5	mA (max)
	Mono	4.3		mA	
I_{SD}	Shutdown Supply Current	CC HP Mode			
		Stereo	4.0	5.25	mA (max)
		Mono	3.3		mA
		Stereo LS + HP Mode	8.6		mA
				0.03	2
V_{OS}	Output Offset Voltage	Speaker (mode 1)	8.9	48.9	mV (max)
		OCL HP (mode 1)	5.6	24.5	mV (max)
P_{OUT}	Output Power	LS Mode, $f = 1\text{ kHz}$			
		$R_L = 4\Omega$, THD+N = 10%	820		mW
		$R_L = 4\Omega$, THD+N = 1%	662		mW
		$R_L = 8\Omega$, THD+N = 10%	515		mW
		$R_L = 8\Omega$, THD+N = 1%	415	340	mW (min)
		OCP HP Mode, $f = 1\text{ kHz}$			
		$R_L = 16\Omega$, THD+N = 10%	62.5		mW
		$R_L = 16\Omega$, THD+N = 1%	50		mW
		$R_L = 32\Omega$, THD+N = 10%	37.5		mW
		$R_L = 32\Omega$, THD+N = 1%	30.3		mW
		CC HP Mode, $f = 1\text{ kHz}$			
		$R_L = 16\Omega$, THD+N = 10%	63		mW
$R_L = 16\Omega$, THD+N = 1%	50		mW		
$R_L = 32\Omega$, THD+N = 10%	38		mW		
$R_L = 32\Omega$, THD+N = 1%	30		mW (min)		

Electrical Characteristics $V_{DD} = 3.0V$ (Notes 1, 2) The following specifications apply for $A_V = 0dB$, $R_{L(SP)} = 15\mu H + 8\Omega + 15\mu H$, $R_{L(HP)} = 32\Omega$, $f = 1kHz$ unless otherwise specified. Limits apply for $T_A = 25^\circ C$. (Continued)

Symbol	Parameter	Conditions	LM4949		Units (Limits)
			Typical	Limit	
			(Note 6)	(Notes 7, 8)	
THD+N	Total Harmonic Distortion + Noise	Differential Mode, $f = 1kHz$			
		HP Mode, $R_L = 16\Omega$, $P_{OUT} = 35mW$			
		OCL	0.015		%
		CC	0.012		%
		HP Mode, $R_L = 32\Omega$, $P_{OUT} = 20mW$			
		OCL	0.017		%
		CC	0.018		%
		LS Mode			
$R_L = 4\Omega$, $P_{OUT} = 300mW$	0.023		%		
$R_L = 8\Omega$, $P_{OUT} = 150mW$	0.02		%		
THD+N	Total Harmonic Distortion + Noise	Single-Ended Input Mode, $f = 1kHz$			
		HP Mode, $R_L = 16\Omega$, $P_{OUT} = 35mW$			
		OCL	0.023		%
		CC	0.017		%
		HP Mode, $R_L = 32\Omega$, $P_{OUT} = 20mW$			
		OCL	0.019		%
		CC	0.013		%
		LS Mode			
$R_L = 4\Omega$, $P_{OUT} = 300mW$	0.05		%		
$R_L = 8\Omega$, $P_{OUT} = 150mW$	0.03		%		
e_N	Noise	Differential Input, A-weighted, Input Referred			
		Mono Input			
		OCL	16.4		μV
		CC	15.5		μV
		LS	43		μV
		All Inputs ON			
		OCL	29.8		μV
		CC	29.2		μV
		LS	46.6		μV
		Single-Ended Input, A-weighted, Input Referred			
		Stereo Input			
		OCL	12		μV
		CC	11		μV
		LA	45		μV
All Inputs ON					
OCL	23.7		μV		
CC	22.9		μV		
LS	52		μV		
η	Efficiency	LS Mode, $P_{OUT} = 400mW$, $R_L = 8\Omega$	85.3		%
Xtalk	Crosstalk	LS Mode, $f = 1kHz$, $R_L = 8\Omega$, $V_{IN} = 1V_{P-P}$			
		Differential Input Mode	84.7		dB
		OCL HP Mode, $f = 1kHz$, $R_L = 32\Omega$, $V_{IN} = 1V_{P-P}$			
		Differential Input Mode	68		dB
T_{ON}	Turn on Time	CC Mode	68		ms
		OCL Mode	14		ms
		LS Mode	29		ms
T_{OFF}	Turn off Time	From any mode	683		ms

Electrical Characteristics $V_{DD} = 3.0V$ (Notes 1, 2) The following specifications apply for $A_V = 0dB$, $R_{L(SP)} = 15\mu H + 8\Omega + 15\mu H$, $R_{L(HP)} = 32\Omega$, $f = 1kHz$ unless otherwise specified. Limits apply for $T_A = 25^\circ C$. (Continued)

Symbol	Parameter	Conditions	LM4949		Units (Limits)	
			Typical	Limit		
			(Note 6)	(Notes 7, 8)		
Z_{IN}	Input Impedance	Maximum Gain	24.8		$k\Omega$	
		Minimum Gain	222.7		$k\Omega$	
A_V	Gain	Volume Control				
		Minimum Gain	-57		dB	
		Maximum Gain	18		dB	
		LS Second Gain Stage				
		Step 0				
		Differential Input	6		dB	
		Single-Ended Input	12		dB	
		Step 1				
		Differential Input	4		dB	
		Single-Ended Input	10		dB	
		Step 2				
		Differential Input	2		dB	
		Single-Ended Input	8		dB	
		Step 3				
Differential Input	0		dB			
Single-Ended Input	6		dB			
HP Second Gain Stage						
Step 0	0		dB			
Step 1	-6		dB			
Step 2	-12		dB			
Mute	Mute Attenuation	Speaker Mode	-103		dB	
		Headphone Mode	-123		dB	
CMRR	Common Mode Rejection Ratio	Speaker Mode, $f = 1kHz$, $V_{IN} = 200mV_{P-P}$	66.1		dB	
		OCL Headphone Mode, $f = 1kHz$, $V_{IN} = 200mV_{P-P}$	70		dB	
PSRR	Power Supply Rejection Ratio	Differential Input Mode, $V_{RIPPLE} = 200mV_{P-P}$				
		OCL HP Mode, $f = 217Hz$	78.1		dB	
		OCL HP Mode, $f = 1kHz$	75.4		dB	
		LS Mode, $f = 217Hz$	74		dB	
		LS Mode, $f = 1kHz$	72.9		dB	
PSRR	Power Supply Rejection Ratio	Single-Ended Input Mode, $V_{RIPPLE} = 200mV_{P-P}$				
		OCL HP Mode, $f = 217Hz$	77.5		dB	
		OCL HP Mode, $f = 1kHz$	81		dB	
		LS Mode, $f = 217Hz$	69		dB	
		LS Mode, $f = 70.31kHz$	72.8		dB	
PSRR	Power Supply Rejection Ratio	All Inputs ON, Single-Ended Input Mode, $V_{RIPPLE} = 200mV_{P-P}$				
		OCL HP Mode, $f = 217Hz$	66.1		dB	
		OCL HP Mode, $f = 1kHz$	70.5		dB	
		LS Mode, $f = 217Hz$	65.4		dB	
		LS Mode, $f = 1kHz$	72.2		dB	

Electrical Characteristics $V_{DD} = 3.6V$ (Notes 1, 2) The following specifications apply for $A_V = 0dB$, $R_{L(SP)} = 15\mu H + 8\Omega + 15\mu H$, $R_{L(HP)} = 32\Omega$, $f = 1kHz$ unless otherwise specified. Limits apply for $T_A = 25^\circ C$.

Symbol	Parameter	Conditions	LM4949		Units (Limits)
			Typical	Limit	
			(Note 6)	(Notes 7, 8)	
I_{DD}	Supply Current	LS Mode			
		Stereo	6.8	7.3	mA (max)
		Mono	4.9	5.3	mA (max)
		OCL HP Mode			
		Stereo	5.8	6.5	mA (max)
		Mono	4.9	5.5	mA (max)
		CC HP Mode			
		Stereo	4.7	5.2	mA (max)
Mono	4.1	4.6	mA (max)		
		Stereo LS + HP Mode	9.36		mA
I_{SD}	Shutdown Supply Current		0.03	1	μA (max)
V_{OS}	Output Offset Voltage	Headphone	6.7	20	mV (max)
		Speaker	8.9	49	mV (max)
P_{OUT}	Output Power	LS Mode, $f = 1 kHz$			
		$R_L = 4\Omega$, THD+N = 10%	1.24		W
		$R_L = 4\Omega$, THD+N = 1%	1		W
		$R_L = 8\Omega$, THD+N = 10%	0.765		W
		$R_L = 8\Omega$, THD+N = 1%	0.615		W
		OCL HP Mode, $f = 1 kHz$			
		$R_L = 16\Omega$, THD+N = 10%	94		mW
		$R_L = 16\Omega$, THD+N = 1%	76		mW
		$R_L = 32\Omega$, THD+N = 10%	55		mW
		$R_L = 32\Omega$, THD+N = 1%	45		mW
		CC HP Mode, $f = 1 kHz$			
		$R_L = 16\Omega$, THD+N = 10%	93		mW
$R_L = 16\Omega$, THD+N = 1%	75		mW		
$R_L = 32\Omega$, THD+N = 10%	56		mW		
$R_L = 32\Omega$, THD+N = 1%	45		mW		
THD+N	Total Harmonic Distortion + Noise	Differential Mode, $f = 1kHz$			
		HP Mode, $R_L = 16\Omega$, $P_{OUT} = 50mW$			
		OCL	0.021		%
		CC	0.021		%
		HP Mode, $R_L = 32\Omega$, $P_{OUT} = 30mW$			
		OCL	0.01		%
		CC	0.01		%
		LS Mode			
$R_L = 4\Omega$, $P_{OUT} = 400mW$	0.023		%		
$R_L = 8\Omega$, $P_{OUT} = 300mW$	0.02		%		
THD+N	Total Harmonic Distortion + Noise	Single-Ended Input Mode, $f = 1kHz$			
		HP Mode, $R_L = 16\Omega$, $P_{OUT} = 50mW$			
		OCL	0.021		%
		CC	0.017		%
		HP Mode, $R_L = 32\Omega$, $P_{OUT} = 30mW$			
		OCL	0.02		%
		CC	0.015		%
		LS Mode			
$R_L = 4\Omega$, $P_{OUT} = 400mW$	0.05		%		
$R_L = 8\Omega$, $P_{OUT} = 300mW$	0.034		%		

Electrical Characteristics $V_{DD} = 3.6V$ (Notes 1, 2) The following specifications apply for $A_V = 0dB$, $R_{L(SP)} = 15\mu H + 8\Omega + 15\mu H$, $R_{L(HP)} = 32\Omega$, $f = 1kHz$ unless otherwise specified. Limits apply for $T_A = 25^\circ C$. (Continued)

Symbol	Parameter	Conditions	LM4949		Units (Limits)
			Typical	Limit	
			(Note 6)	(Notes 7, 8)	
e_N	Noise	Differential Mode, A-weighted, Input Referred			
		Mono Input			
		OCL	16.4		μV
		CC	15.5		μV
		LS	43		μV
		All Inputs ON			
		OCL	29.8		μV
		CC	29.2		μV
		LS	46.6		μV
		Single-Ended Input, A-weighted, Input Referred			
		Stereo Input			
		OCL	12		μV
CC	11		μV		
LS	45		μV		
All Inputs ON					
OCL	23.7		μV		
CC	22.9		μV		
LS	52		μV		
η	Efficiency	LS Mode, $P_{OUT} = 400mW$, $R_L = 8\Omega$	86.5		%
Xtalk	Crosstalk	LS Mode, $f = 1kHz$, $R_L = 8\Omega$, $V_{IN} = 1V_{P-P}$			
		Differential Input Mode	86		dB
		OCL HP Mode, $f = 1kHz$, $R_L = 32\Omega$, $V_{IN} = 1V_{P-P}$			
		Differential Input Mode	68		dB
T_{ON}	Turn on Time	CC Mode	75		ms
		OCL Mode	14		ms
		LS Mode	31		
T_{OFF}	Turn off Time	From any mode	692		ms
Z_{IN}	Input Impedance	Maximum Gain	24.8		$k\Omega$
		Minimum Gain	222.7		$k\Omega$

Electrical Characteristics $V_{DD} = 3.6V$ (Notes 1, 2) The following specifications apply for $A_V = 0dB$, $R_{L(SP)} = 15\mu H + 8\Omega + 15\mu H$, $R_{L(HP)} = 32\Omega$, $f = 1kHz$ unless otherwise specified. Limits apply for $T_A = 25^\circ C$. (Continued)

Symbol	Parameter	Conditions	LM4949		Units (Limits)	
			Typical	Limit		
			(Note 6)	(Notes 7, 8)		
A_V	Gain	Volume Control				
		Minimum Gain	-57		dB	
		Maximum Gain	18		dB	
		LS Second Gain Stage				
		Step 0				
		Differential Input	6		dB	
		Single-Ended Input	12		dB	
		Step 2				
		Differential Input	4		dB	
		Single-Ended Input	10		dB	
		Step 2				
		Differential Input	2		dB	
		Single-Ended Input	8		dB	
		Step 3				
Differential Input	0		dB			
Single-Ended Input	6		dB			
HP Second Gain Stage						
Step 0						
Step 1	-6		dB			
Step 2	-12		dB			
Mute	Mute Attenuation	Speaker Mode	-84		dB	
		Headphone Mode	-95		dB	
CMRR	Common Mode Rejection Ratio	Speaker Mode, $f = 1kHz$, $V_{IN} = 200mV_{P-P}$	66		dB	
		OCL Headphone Mode, $f = 1kHz$, $V_{IN} = 200mV_{P-P}$	68.6		dB	
PSRR	Power Supply Rejection Ratio	Differential Input Mode, $V_{RIPPLE} = 200mV_{P-P}$				
		OCL HP Mode, $f = 217Hz$	75		dB	
		OCL HP Mode, $f = 1kHz$	75		dB	
		LS Mode, $f = 217Hz$	73		dB	
		LS Mode, $f = 1kHz$	73		dB	
PSRR	Power Supply Rejection Ratio	Single-Ended Input Mode, $V_{RIPPLE} = 200mV_{P-P}$				
		OCL HP Mode, $f = 217Hz$	75		dB	
		OCL HP Mode, $f = 1kHz$	75		dB	
		LS Mode, $f = 217Hz$	67		dB	
		LS Mode, $f = 1kHz$	71		dB	
PSRR	Power Supply Rejection Ratio	All Inputs ON, Single-Ended Input Mode, $V_{RIPPLE} = 200mV_{P-P}$				
		OCL HP Mode, $f = 217Hz$	72		dB	
		OCL HP Mode, $f = 1kHz$	70		dB	
		LS Mode, $f = 217Hz$	60		dB	
		LS Mode, $f = 1kHz$	65		dB	

Electrical Characteristics $V_{DD} = 5.0V$ (Notes 1, 2) The following specifications apply for $A_v = 0dB$, $R_{L(SP)} = 15\mu H + 8\Omega + 15\mu H$, $R_{L(HP)} = 32\Omega$, $f = 1kHz$ unless otherwise specified. Limits apply for $T_A = 25^\circ C$.

Symbol	Parameter	Conditions	LM4949		Units (Limits)
			Typical	Limit	
			(Note 6)	(Notes 7, 8)	
I_{DD}	Supply Current	LS Mode			
		Stereo	9.9	10.9	mA (max)
		Mono	6.6	7.2	mA (max)
		OCL HP Mode			
		Stereo	6.6	7.3	mA (max)
		Mono	5.5	6.2	mA (max)
		CC HP Mode			
		Stereo	5.4	5.9	mA (max)
		Mono	4.3	4.8	mA (max)
		Stereo LS + HP Mode	13		mA
I_{SD}	Shutdown Supply Current		0.1	1	μA (max)
V_{OS}	Output Offset Voltage	Headphone	10	52	mV (max)
		Speaker	9.6	50	mV (max)
P_{OUT}	Output Power	LS Mode, $f = 1 kHz$			
		$R_L = 4\Omega$, THD+N = 10%	2.5		W
		$R_L = 4\Omega$, THD+N = 1%	2.01		W
		$R_L = 8\Omega$, THD+N = 10%	1.48		W
		$R_L = 8\Omega$, THD+N = 1%	1.19		W
		OCL HP Mode, $f = 1 kHz$			
		$R_L = 16\Omega$, THD+N = 10%	190		mW
		$R_L = 16\Omega$, THD+N = 1%	154		mW
		$R_L = 32\Omega$, THD+N = 10%	109		mW
		$R_L = 32\Omega$, THD+N = 1%	89		mW
		CC HP Mode, $f = 1 kHz$			
		$R_L = 16\Omega$, THD+N = 10%	188		mW
$R_L = 16\Omega$, THD+N = 1%	153		mW		
$R_L = 32\Omega$, THD+N = 10%	105		mW		
$R_L = 32\Omega$, THD+N = 1%	88		mW		
THD + N	Total Harmonic Distortion + Noise	Differential Input Mode, $f = 1kHz$			
		HP Mode, $R_L = 16\Omega$, $P_{OUT} = 100mW$			
		OCL	0.02		%
		CC	0.027		%
		HP Mode, $R_L = 32\Omega$, $P_{OUT} = 50mW$			
		OCL	0.02		%
		CC	0.022		%
		LS Mode			
$R_L = 4\Omega$, $P_{OUT} = 1W$	0.022		%		
$R_L = 8\Omega$, $P_{OUT} = 600mW$	0.02		%		

Electrical Characteristics $V_{DD} = 5.0V$ (Notes 1, 2) The following specifications apply for $A_V = 0dB$, $R_{L(SP)} = 15\mu H + 8\Omega + 15\mu H$, $R_{L(HP)} = 32\Omega$, $f = 1kHz$ unless otherwise specified. Limits apply for $T_A = 25^\circ C$. (Continued)

Symbol	Parameter	Conditions	LM4949		Units (Limits)	
			Typical	Limit		
			(Note 6)	(Notes 7, 8)		
THD + N	Total Harmonic Distortion + Noise	Single-Ended Input Mode, $f = 1kHz$				
		HP Mode, $R_L = 16\Omega$, $P_{OUT} = 100mW$				
		OCL	0.021		%	
		CC	0.02		%	
		HP Mode, $R_L = 32\Omega$, $P_{OUT} = 50mW$				
		OCL	0.02		%	
		CC	0.017		%	
		LS Mode				
		$R_L = 4\Omega$, $P_{OUT} = 1W$	0.05		%	
		$R_L = 8\Omega$, $P_{OUT} = 600mW$	0.033		%	
e_N	Noise	Differential Input, A-weighted, Input Referred				
		Mono Input				
		OCL	16.4		μV	
		CC	15.5		μV	
		LS	43		μV	
		All Inputs ON				
		OCL	29.8		μV	
		CC	29.2		μV	
		LS	46.6		μV	
		Single-Ended Input, A-weighted, Input Referred				
		Stereo Input				
		OCL	12		μV	
		CC	11		μV	
LS	45		μV			
All Inputs ON						
OCL	23.7		μV			
CC	22.9		μV			
LS	52		μV			
η	Efficiency	LS Mode, $P_{OUT} = 1W$, $R_L = 8\Omega$	87.4		%	
Xtalk	Crosstalk	LS Mode, $f = 1kHz$, $R_L = 8\Omega$, $V_{IN} = 1V_{P-P}$				
		Differential Input Mode		105.8		dB
		OCL HP Mode, $f = 1kHz$, $R_L = 32\Omega$, $V_{IN} = 1V_{P-P}$				
		Differential Input Mode		69.6		dB
T_{ON}	Turn on Time	CC Mode	89		ms	
		OCL Mode	14		ms	
		LS Mode	35		ms	
T_{OFF}	Turn off Time	From any mode	716		ms	
Z_{IN}	Input Impedance	Maximum Gain	24.8		$k\Omega$	
		Minimum Gain	222.7		$k\Omega$	

Electrical Characteristics $V_{DD} = 5.0V$ (Notes 1, 2) The following specifications apply for $A_V = 0dB$, $R_{L(SP)} = 15\mu H + 8\Omega + 15\mu H$, $R_{L(HP)} = 32\Omega$, $f = 1kHz$ unless otherwise specified. Limits apply for $T_A = 25^\circ C$. (Continued)

Symbol	Parameter	Conditions	LM4949		Units (Limits)	
			Typical	Limit		
			(Note 6)	(Notes 7, 8)		
A_V	Gain	Volume Control				
		Minimum Gain	-57		dB	
		Maximum Gain	18		dB	
		LS Second Gain Stage				
		Step 0				
		Differential Input	6		dB	
		Single-Ended Input	12		dB	
		Step 1				
		Differential Input	4		dB	
		Single-Ended Input	10		dB	
		Step 2				
		Differential Input	8		dB	
		Single-Ended Input	2		dB	
Step 3						
Differential Input	0		dB			
Single-Ended Input	6		dB			
HP Second Gain Stage						
Step 0	0		dB			
Step 1	-6		dB			
Step 2	-12		dB			
Mute	Mute Attenuation	Speaker Mode	-102.7		dB	
		Headphone Mode	-123		dB	
CMRR	Common Mode Rejection Ratio	Speaker Mode, $f = 1kHz$, $V_{IN} = 200mV_{P-P}$	64.4		dB	
		OCL Headphone Mode, $f = 1kHz$, $V_{IN} = 200mV_{P-P}$	74.3		dB	
PSRR	Power Supply Rejection Ratio	Differential Input Mode, $V_{RIPPLE} = 200mV_{P-P}$				
		OCL HP Mode, $f = 217Hz$	68.3		dB	
		OCL HP Mode, $f = 1kHz$	67.9		dB	
		LS Mode, $f = 217Hz$	73.8		dB	
		LS Mode, $f = 1kHz$	72		dB	
PSRR	Power Supply Rejection Ratio	Single-Ended Input Mode, $V_{RIPPLE} = 200mV_{P-P}$				
		OCL HP Mode, $f = 217Hz$	70.55		dB	
		OCL HP Mode, $f = 1kHz$	63.05		dB	
		LS Mode, $f = 217Hz$	64.6		dB	
		LS Mode, $f = 1kHz$	70.3		dB	
PSRR	Power Supply Rejection Ratio	All Inputs ON, Single-Ended Input Mode, $V_{RIPPLE} = 200mV_{P-P}$				
		OCL HP Mode, $f = 217Hz$	63.1		dB	
		OCL HP Mode, $f = 1kHz$	66.4		dB	
		LS Mode, $f = 217Hz$	59.1		dB	
		LS Mode, $f = 1kHz$	69.3		dB	

Electrical Characteristics $V_{DD} = 5.0V$ (Notes 1, 2) The following specifications apply for $A_v = 0dB$, $R_{L(SP)} = 15\mu H + 8\Omega + 15\mu H$, $R_{L(HP)} = 32\Omega$, $f = 1kHz$ unless otherwise specified. Limits apply for $T_A = 25^\circ C$. (Continued)

Note 1: All voltages are measured with respect to the ground pin, unless otherwise specified.

Note 2: *Absolute Maximum Ratings* indicate limits beyond which damage to the device may occur. *Operating Ratings* indicate conditions for which the device is functional, but do not guarantee specific performance limits. *Electrical Characteristics* state DC and AC electrical specifications under particular test conditions which guarantee specific performance limits. This assumes that the device is within the Operating Ratings. Specifications are not guaranteed for parameters where no limit is given, however, the typical value is a good indication of device performance.

Note 3: The maximum power dissipation must be derated at elevated temperatures and is dictated by T_{JMAX} , θ_{JA} , and the ambient temperature T_A . The maximum allowable power dissipation is $P_{DMAX} = (T_{JMAX} - T_A) / \theta_{JA}$ or the number given in Absolute Maximum Ratings, whichever is lower. For the LM4949, see power derating currents for additional information.

Note 4: Human body model, 100pF discharged through a 1.5k Ω resistor.

Note 5: Machine Model, 220pF – 240pF discharged through all pins.

Note 6: Typicals are measured at 25°C and represent the parametric norm.

Note 7: Limits are guaranteed to National's AOQL (Average Outgoing Quality Level).

Note 8: Datasheet min/max specification limits are guaranteed by design, test or statistical analysis.

TABLE 1. Bump Description

BUMP	NAME	DESCRIPTION
A1	LLS-	Left Channel Loudspeaker Inverting Output
A2	LLS+	Left Channel Loudspeaker Non-inverting Output
A3	SDA	Serial Data Input
A4	HPGND	Headphone Ground
A5	HPR	Right Channel Headphone Output
B1	VDDL	Speaker Power Supply
B2	ADR	Address Select Bit
B3	RIN-	Right Channel Inverting Input
B4	HPL	Left Channel Headphone Output
B5	VOC	Headphone Return Bias Output
C1	GNDL	Speaker Ground
C2	VDD	Power Supply
C3	RIN+	Right Channel Non-Inverting Input
C4	LIN+	Left Channel Non-inverting Input
C5	VDDHP	Headphone Power Supply
D1	VDDL	Speaker Power Supply
D2	I ² CVDD	I ² C Power Supply
D3	SCL	Serial Clock Input
D4	MIN+	Mono Channel Non-inverting Input
D5	LIN-	Left Channel Inverting Input
E1	RLS-	Right Channel Loudspeaker Inverting Output
E2	RLS+	Right Channel Loudspeaker Non-inverting Output
E3	GND	Ground
E4	MIN-	Mono Channel Inverting Input
E5	BYPASS	Mid-rail Bias Bypass

Typical Performance Characteristics

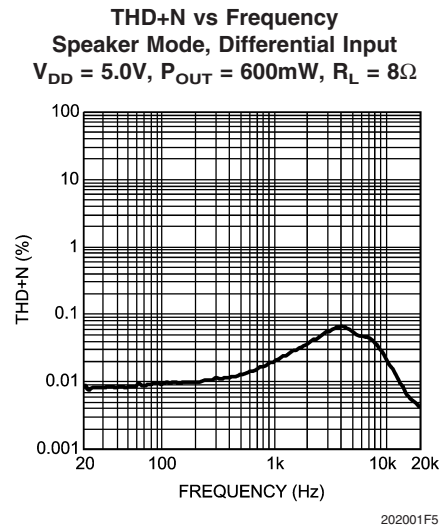
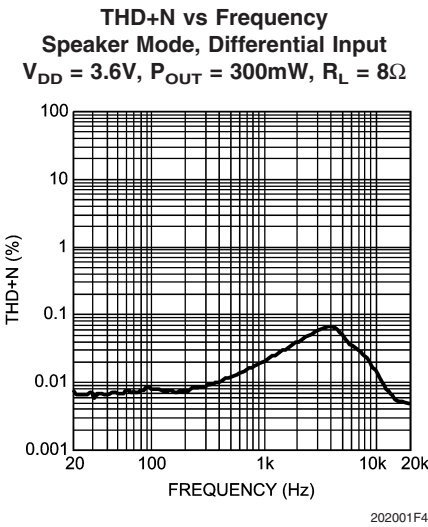
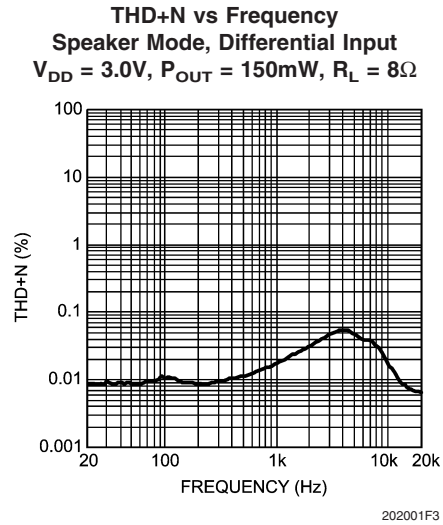
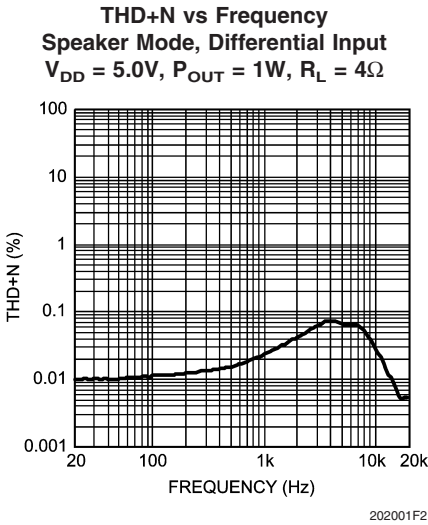
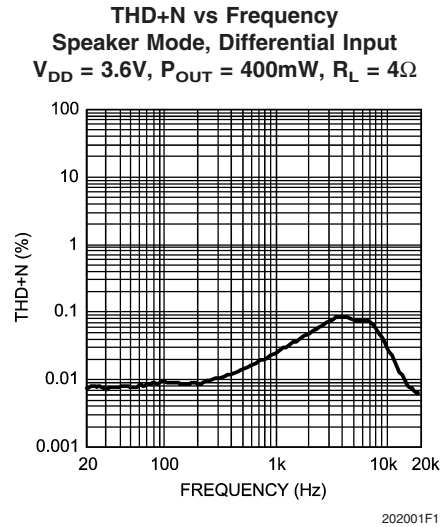
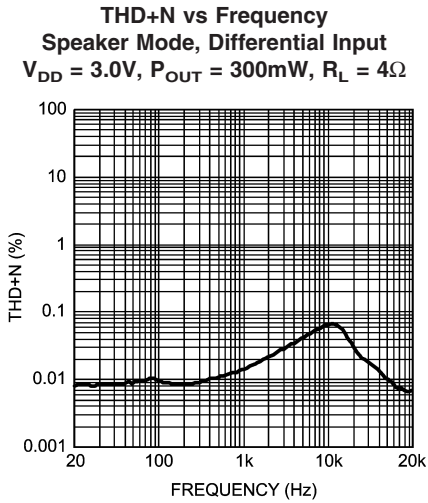

Typical Performance Characteristics (Continued)

THD+N vs Frequency
Speaker Mode, Single-Ended Input
 $V_{DD} = 3.0V, P_{OUT} = 300mW, R_L = 4\Omega$

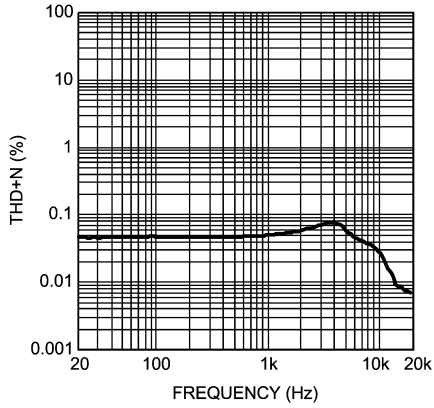

202001F6

THD+N vs Frequency
Speaker Mode, Single-Ended Input
 $V_{DD} = 3.6V, P_{OUT} = 400mW, R_L = 4\Omega$

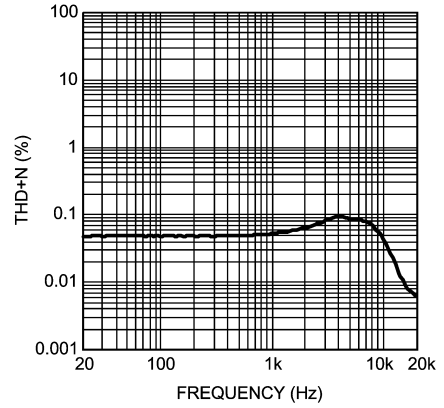

202001F7

THD+N vs Frequency
Speaker Mode, Single-Ended Input
 $V_{DD} = 5.0V, P_{OUT} = 1W, R_L = 4\Omega$

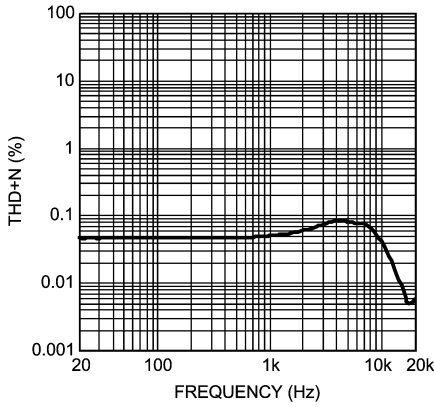

202001F8

THD+N vs Frequency
Speaker Mode, Single-Ended Input
 $V_{DD} = 3.0V, P_{OUT} = 150mW, R_L = 8\Omega$

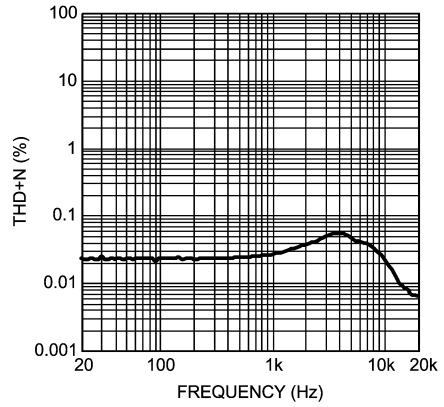

202001F9

THD+N vs Frequency
Speaker Mode, Single-Ended Input
 $V_{DD} = 3.6V, P_{OUT} = 300mW, R_L = 8\Omega$

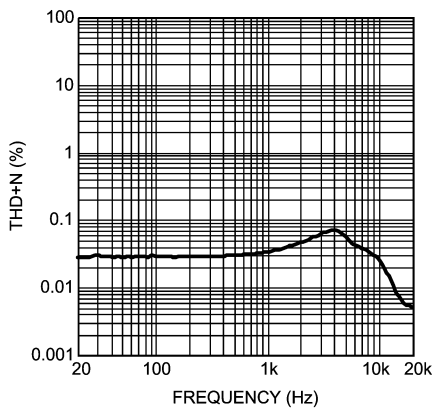

202001G0

THD+N vs Frequency
Speaker Mode, Single-Ended Input
 $V_{DD} = 5.0V, P_{OUT} = 600mW, R_L = 8\Omega$

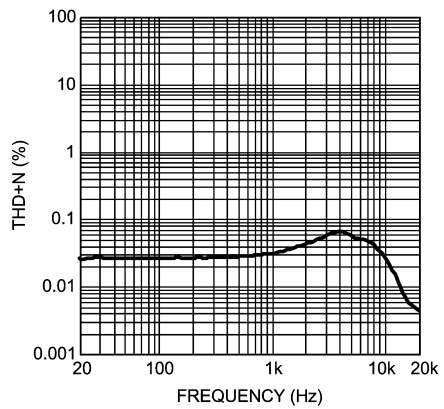

202001G1

Typical Performance Characteristics (Continued)

THD+N vs Frequency
OCL Headphone Mode, Differential Input
 $V_{DD} = 3.0V, P_{OUT} = 35mW, R_L = 16\Omega$

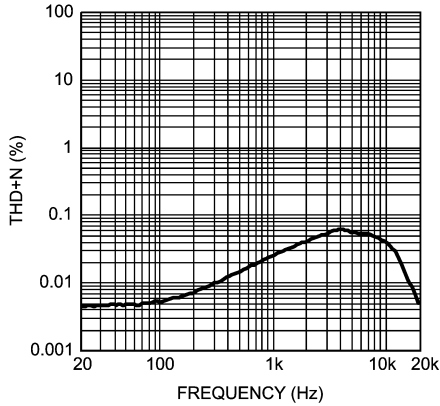

202001G2

THD+N vs Frequency
OCL Headphone Mode, Differential Input
 $V_{DD} = 3.6V, P_{OUT} = 50mW, R_L = 16\Omega$

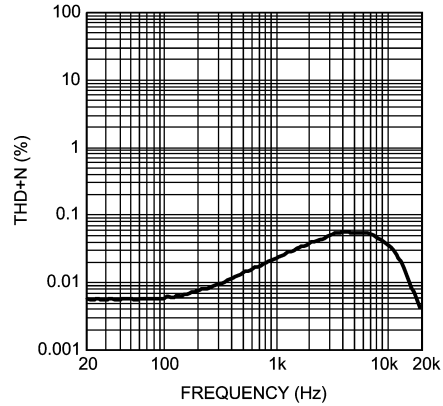

202001G3

THD+N vs Frequency
OCL Headphone Mode, Differential Input
 $V_{DD} = 5.0V, P_{OUT} = 100mW, R_L = 16\Omega$

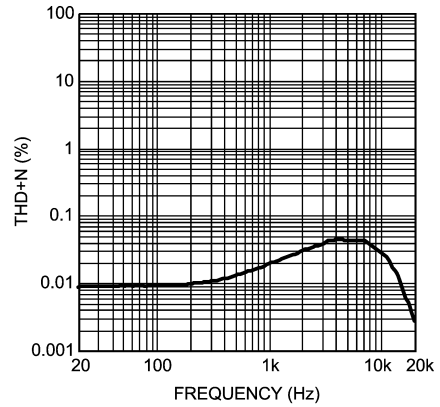

202001G4

THD+N vs Frequency
OCL Headphone Mode, Differential Input
 $V_{DD} = 3.0V, P_{OUT} = 20mW, R_L = 32\Omega$

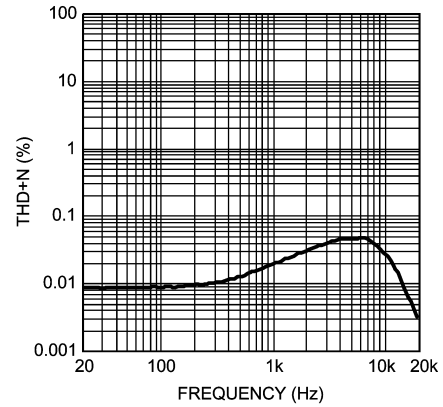

202001G5

THD+N vs Frequency
OCL Headphone Mode, Differential Input
 $V_{DD} = 3.6V, P_{OUT} = 30mW, R_L = 32\Omega$

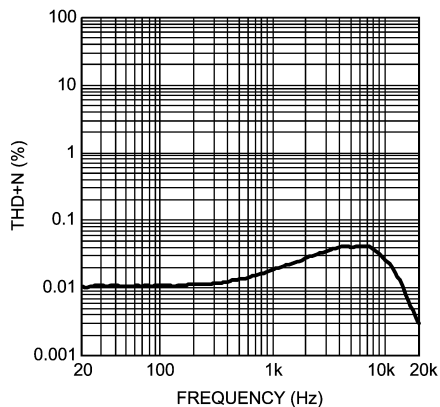

202001G6

THD+N vs Frequency
OCL Headphone Mode, Differential Input
 $V_{DD} = 5.0V, P_{OUT} = 50mW, R_L = 32\Omega$

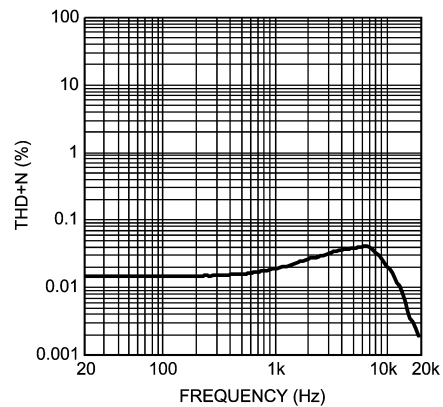

202001G7

Typical Performance Characteristics (Continued)

THD+N vs Frequency
OCL Headphone Mode, Single-Ended Input
 $V_{DD} = 3.0V, P_{OUT} = 35mW, R_L = 16\Omega$

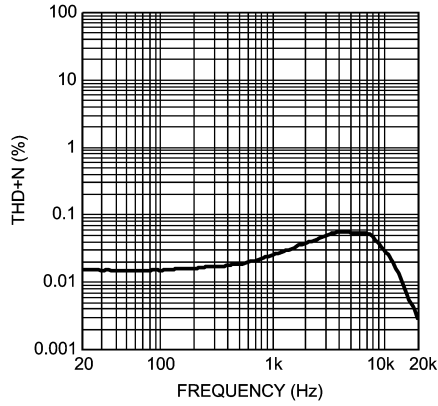

THD+N vs Frequency
OCL Headphone Mode, Single-Ended Input
 $V_{DD} = 3.6V, P_{OUT} = 50mW, R_L = 16\Omega$

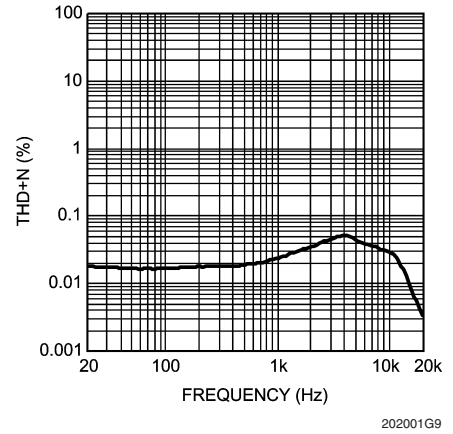

THD+N vs Frequency
OCL Headphone Mode, Single-Ended Input
 $V_{DD} = 5.0V, P_{OUT} = 100mW, R_L = 16\Omega$

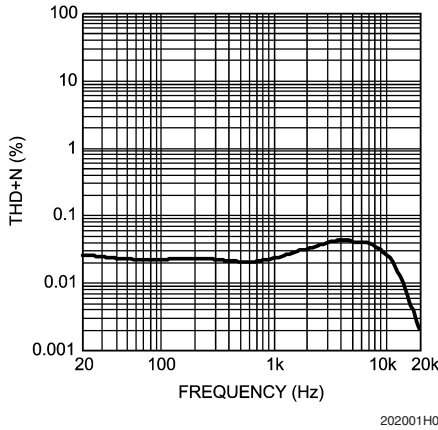

THD+N vs Frequency
OCL Headphone Mode, Single-Ended Input
 $V_{DD} = 3.0V, P_{OUT} = 20mW, R_L = 32\Omega$

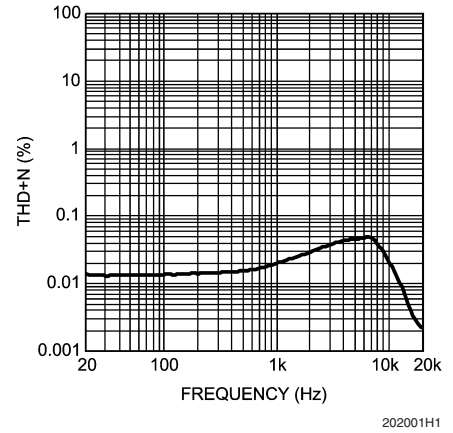

THD+N vs Frequency
OCL Headphone Mode, Single-Ended Input
 $V_{DD} = 3.6V, P_{OUT} = 30mW, R_L = 32\Omega$

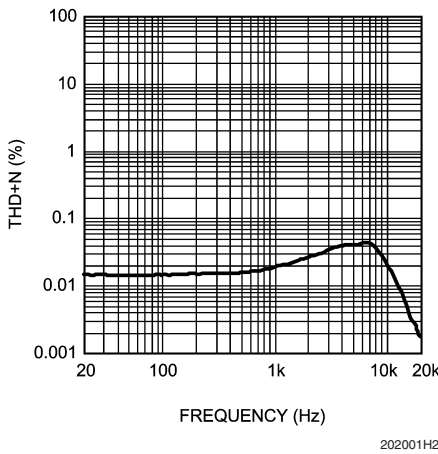

THD+N vs Frequency
OCL Headphone Mode, Single-Ended Input
 $V_{DD} = 5.0V, P_{OUT} = 50mW, R_L = 32\Omega$

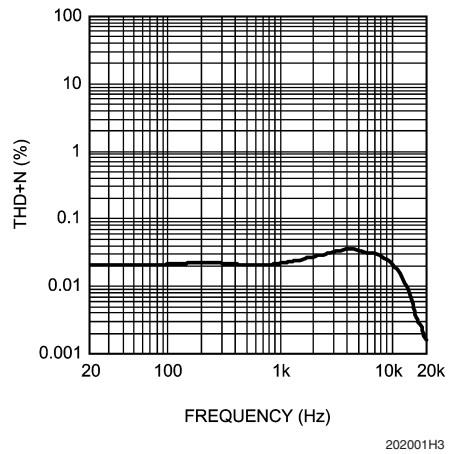

Typical Performance Characteristics (Continued)

THD+N vs Frequency
CC Headphone Mode, Differential Input
 $V_{DD} = 3.0V, P_{OUT} = 35mW, R_L = 16\Omega$

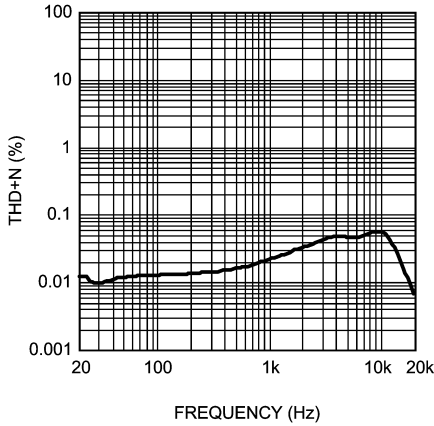

202001H4

THD+N vs Frequency
CC Headphone Mode, Differential Input
 $V_{DD} = 3.6V, P_{OUT} = 50mW, R_L = 16\Omega$

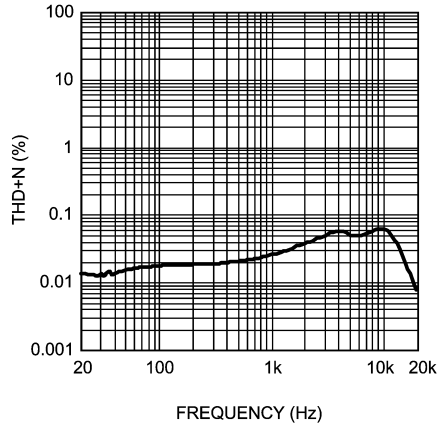

202001H5

THD+N vs Frequency
CC Headphone Mode, Differential Input
 $V_{DD} = 5.0V, P_{OUT} = 100mW, R_L = 16\Omega$

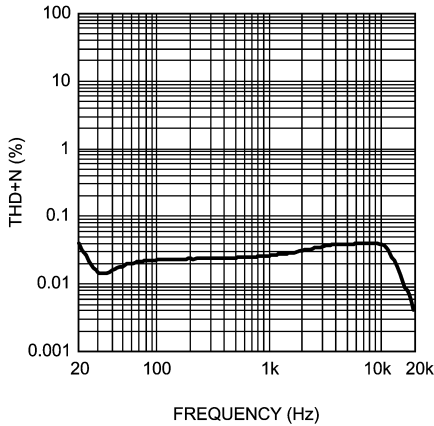

202001H6

THD+N vs Frequency
CC Headphone Mode, Differential Input
 $V_{DD} = 3.0V, P_{OUT} = 20mW, R_L = 32\Omega$

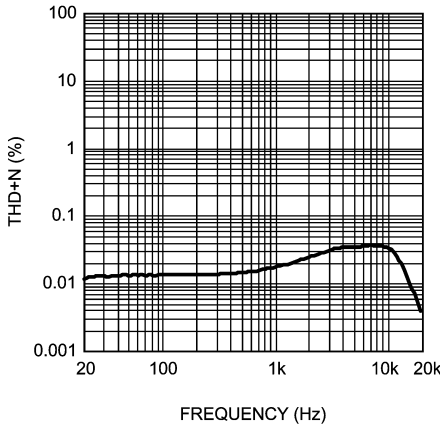

202001H7

THD+N vs Frequency
CC Headphone Mode, Differential Input
 $V_{DD} = 3.6V, P_{OUT} = 30mW, R_L = 32\Omega$

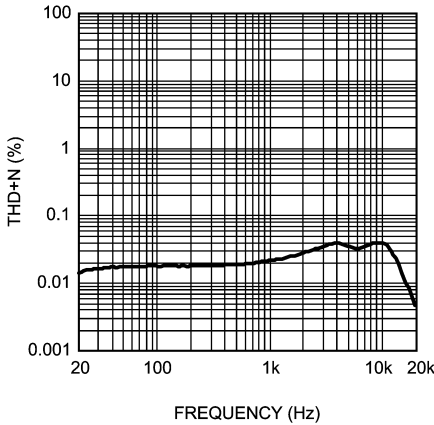

202001H8

THD+N vs Frequency
CC Headphone Mode, Differential Input
 $V_{DD} = 5.0V, P_{OUT} = 50mW, R_L = 32\Omega$

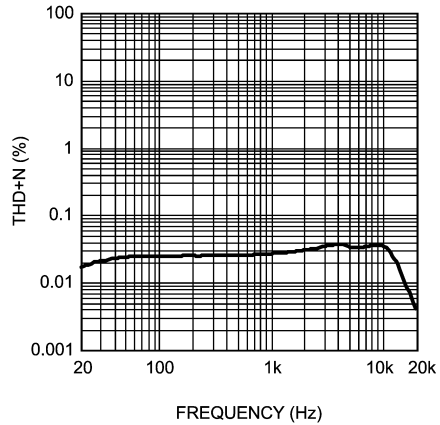

202001H9

Typical Performance Characteristics (Continued)

THD+N vs Frequency
CC Headphone Mode, Single-Ended Input
 $V_{DD} = 3.0V, P_{OUT} = 35mW, R_L = 16\Omega$

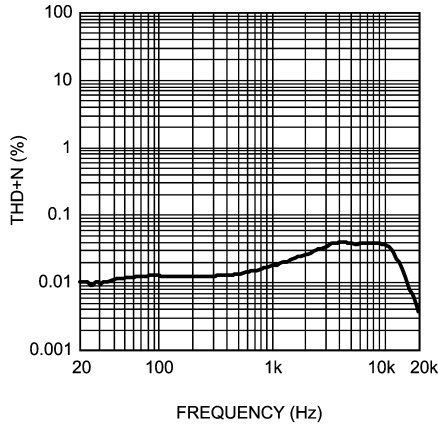

20200113

THD+N vs Frequency
CC Headphone Mode, Single-Ended Input
 $V_{DD} = 3.6V, P_{OUT} = 50mW, R_L = 16\Omega$

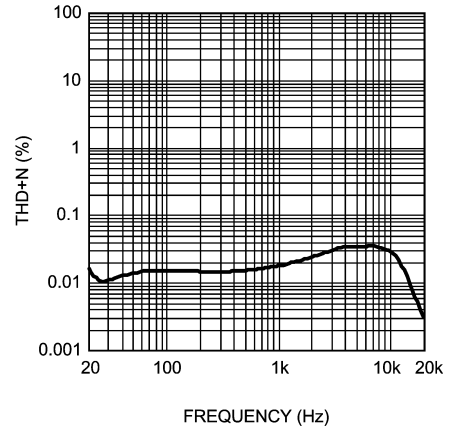

20200114

THD+N vs Frequency
CC Headphone Mode, Single-Ended Input
 $V_{DD} = 5.0V, P_{OUT} = 100mW, R_L = 16\Omega$

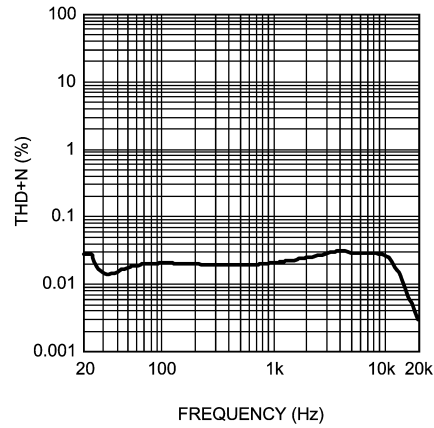

20200115

THD+N vs Frequency
CC Headphone Mode, Single-Ended Input
 $V_{DD} = 3.0V, P_{OUT} = 20mW, R_L = 32\Omega$

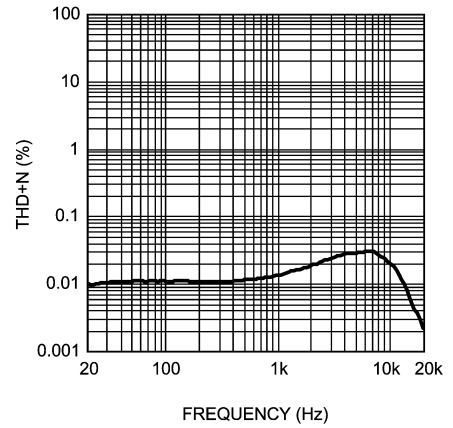

20200116

THD+N vs Frequency
CC Headphone Mode, Single-Ended Input
 $V_{DD} = 3.6V, P_{OUT} = 30mW, R_L = 32\Omega$

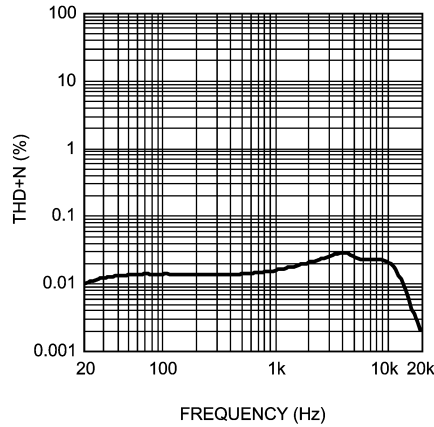

20200117

THD+N vs Frequency
CC Headphone Mode, Single-Ended Input
 $V_{DD} = 5.0V, P_{OUT} = 50mW, R_L = 32\Omega$

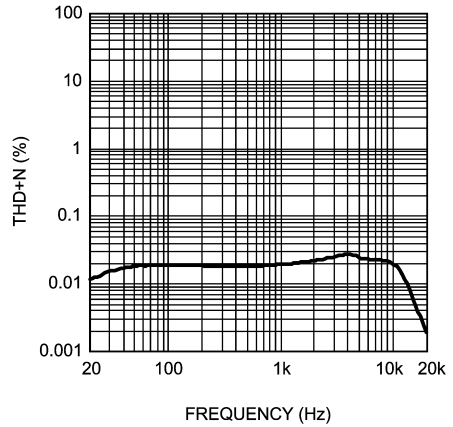

20200118

Typical Performance Characteristics (Continued)

THD+N vs Output Power
Speaker Mode, Differential Input
 $A_V = 6\text{dB}$, $R_L = 4\Omega$, $f = 1\text{kHz}$

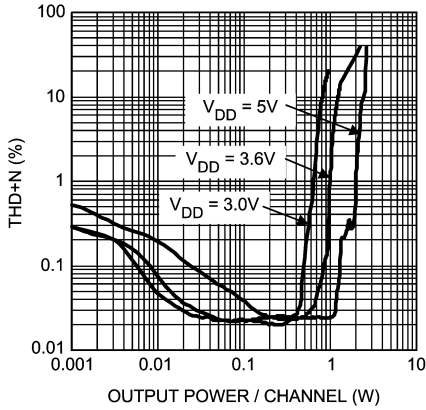

202001D0

THD+N vs Output Power
Speaker Mode, Differential Input
 $A_V = 6\text{dB}$, $R_L = 8\Omega$, $f = 1\text{kHz}$

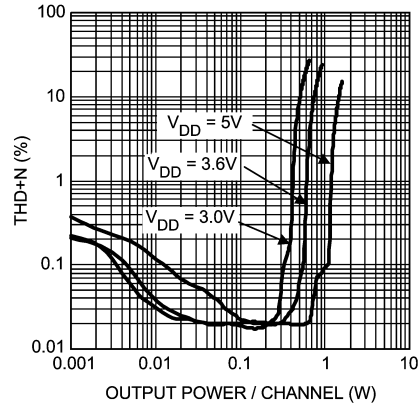

202001D1

THD+N vs Output Power
Speaker Mode, Single-Ended Input
 $A_V = 6\text{dB}$, $R_L = 4\Omega$, $f = 1\text{kHz}$

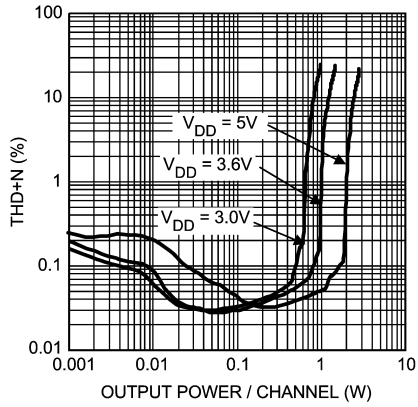

202001D2

THD+N vs Output Power
Speaker Mode, Single-Ended Input
 $A_V = 6\text{dB}$, $R_L = 8\Omega$, $f = 1\text{kHz}$

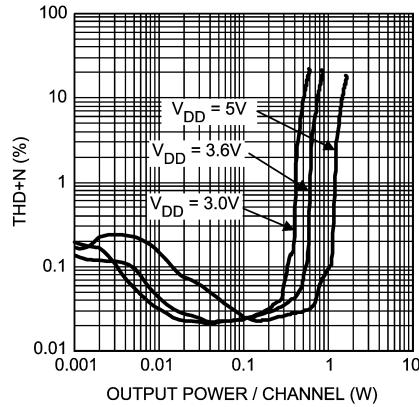

202001D3

THD+N vs Output Power
OCL Headphone Mode, Differential Input
 $A_V = 0\text{dB}$, $R_L = 16\Omega$, $f = 1\text{kHz}$

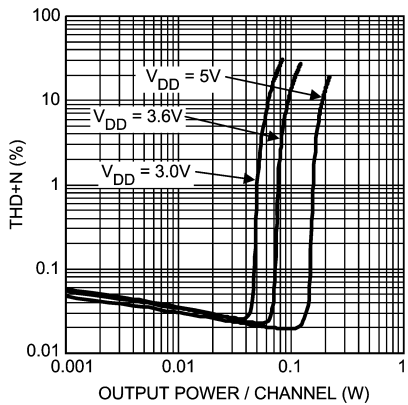

202001D4

THD+N vs Output Power
OCL Headphone Mode, Differential Input
 $A_V = 0\text{dB}$, $R_L = 32\Omega$, $f = 1\text{kHz}$

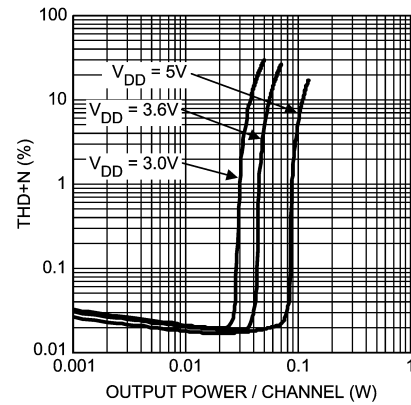

202001D5

Typical Performance Characteristics (Continued)

THD+N vs Output Power
OCL Headphone Mode, Single-Ended Input
 $A_V = 0\text{dB}$, $R_L = 16\Omega$, $f = 1\text{kHz}$

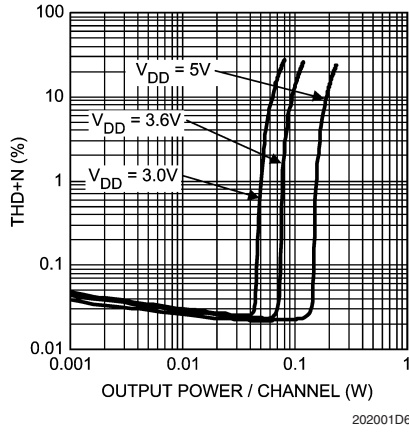

THD+N vs Output Power
OCL Headphone Mode, Single-Ended Input
 $A_V = 0\text{dB}$, $R_L = 32\Omega$, $f = 1\text{kHz}$

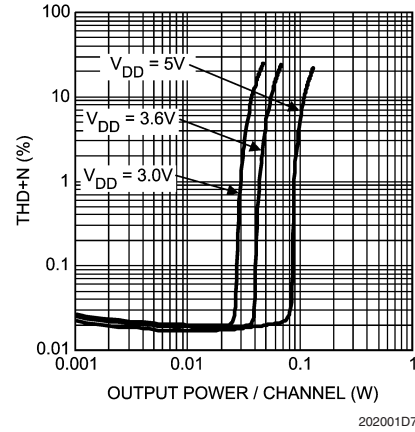

THD+N vs Output Power
CC Headphone Mode, Differential Input
 $A_V = 0\text{dB}$, $R_L = 16\Omega$, $f = 1\text{kHz}$

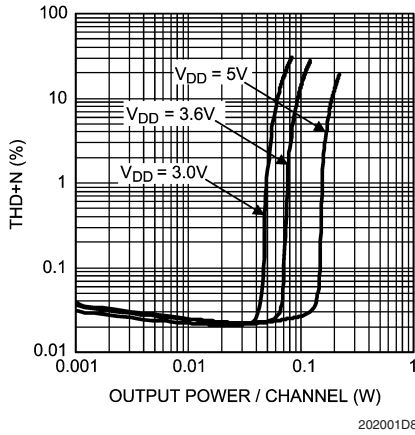

THD+N vs Output Power
CC Headphone Mode, Differential Input
 $A_V = 0\text{dB}$, $R_L = 32\Omega$, $f = 1\text{kHz}$

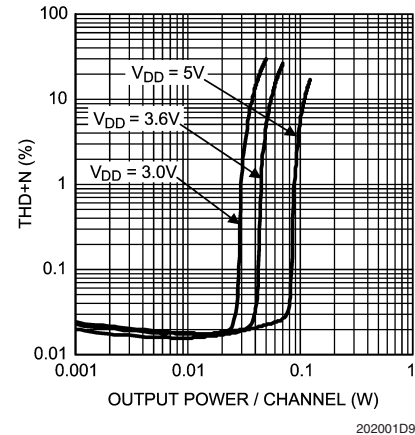

THD+N vs Output Power
CC Headphone Mode, Single-Ended Input
 $A_V = 0\text{dB}$, $R_L = 16\Omega$, $f = 1\text{kHz}$

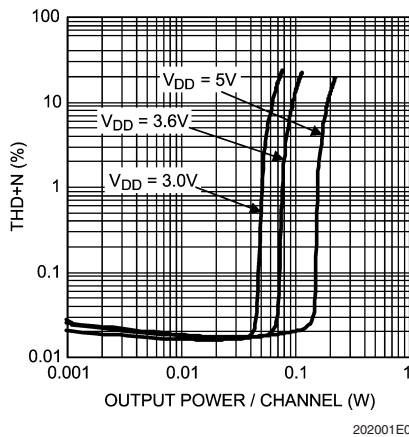

THD+N vs Output Power
CC Headphone Mode, Single-Ended Input
 $A_V = 0\text{dB}$, $R_L = 32\Omega$, $f = 1\text{kHz}$

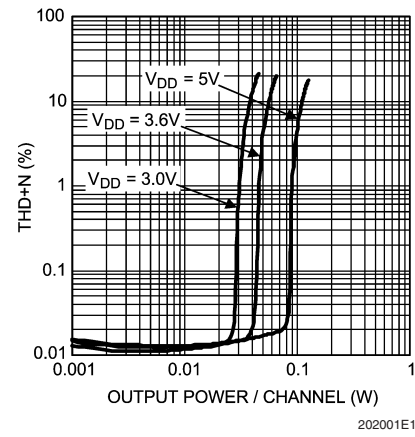

Typical Performance Characteristics (Continued)

PSRR vs Frequency
Speaker Mode, Differential Input
 $V_{DD} = 3.6V, V_{RIPPLE} = 200mV_{P-P}, R_L = 8\Omega$

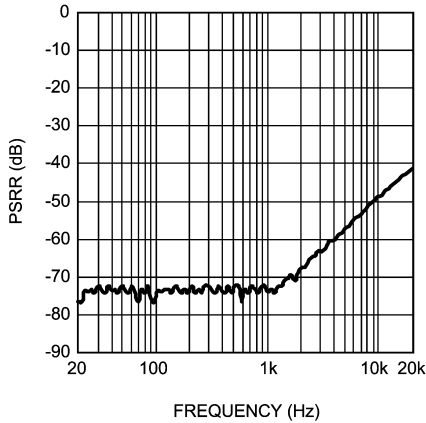

202001I9

PSRR vs Frequency
Speaker Mode, Differential Input
 $V_{DD} = 3.6V, V_{RIPPLE} = 200mV_{P-P}, R_L = 8\Omega$

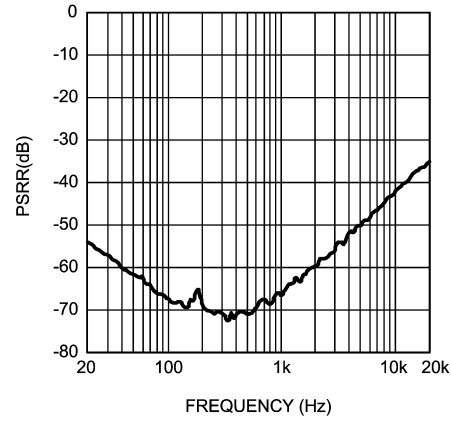

202001J0

PSRR vs Frequency
Speaker Mode, Single-Ended Input
Stereo and Mono Inputs Active
 $V_{DD} = 3.6V, V_{RIPPLE} = 200mV_{P-P}, R_L = 8\Omega$

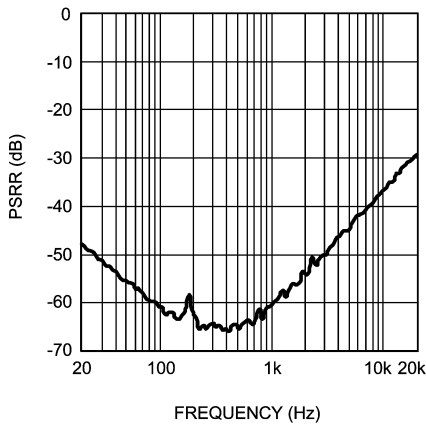

202001J1

PSRR vs Frequency
OCL Headphone Mode, Differential Input
 $V_{DD} = 3.6V, V_{RIPPLE} = 200mV_{P-P}, R_L = 32\Omega$

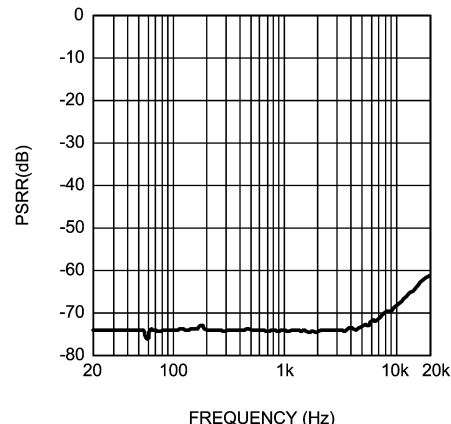

202001J2

PSRR vs Frequency
OCL Headphone Mode, Single-Ended Input
 $V_{DD} = 3.6V, V_{RIPPLE} = 200mV_{P-P}, R_L = 32\Omega$

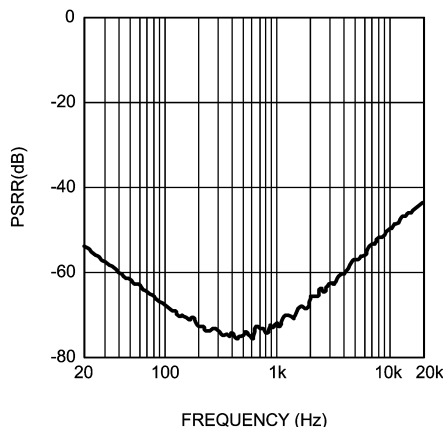

202001J3

PSRR vs Frequency
OCL Headphone Mode, Single-Ended Input
Stereo and Mono Inputs Active
 $V_{DD} = 3.6V, V_{RIPPLE} = 200mV_{P-P}, R_L = 32\Omega$

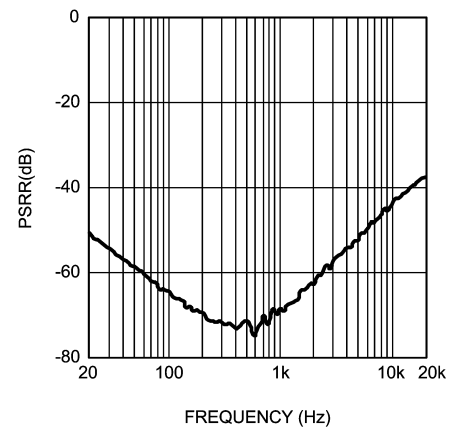

202001J4

Typical Performance Characteristics (Continued)

PSRR vs Frequency
CC Headphone Mode, Differential Input
 $V_{DD} = 3.6V$, $V_{RIPPLE} = 200mV_{P-P}$, $R_L = 32\Omega$

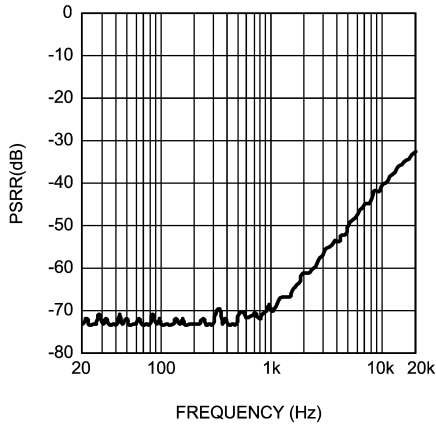

202001J5

PSRR vs Frequency
CC Headphone Mode, Single-Ended Input
 $V_{DD} = 3.6V$, $V_{RIPPLE} = 200mV_{P-P}$, $R_L = 32\Omega$

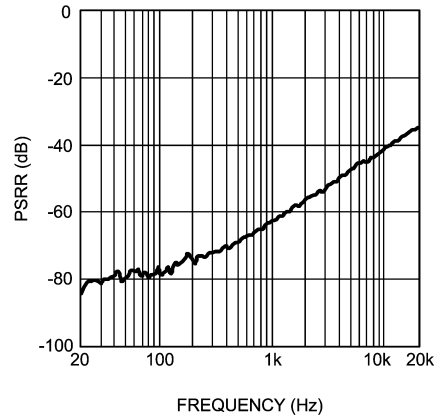

202001J6

PSRR vs Frequency
CC Headphone Mode, Single-Ended Input
Stereo and Mono Inputs Active
 $V_{DD} = 3.6V$, $V_{RIPPLE} = 200mV_{P-P}$, $R_L = 32\Omega$

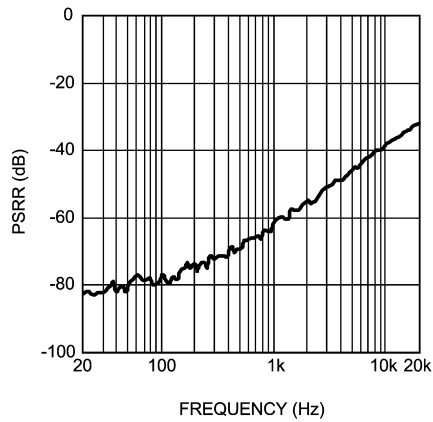

202001J7

Efficiency vs Output Power
Speaker Mode
 $R_L = 32\Omega$, $f = 1kHz$

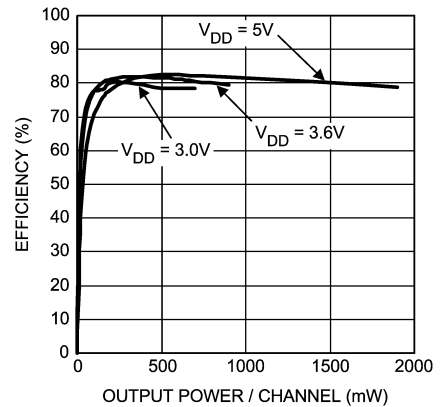

202001E2

Efficiency vs Output Power
Speaker Mode
 $R_L = 8\Omega$, $f = 1kHz$

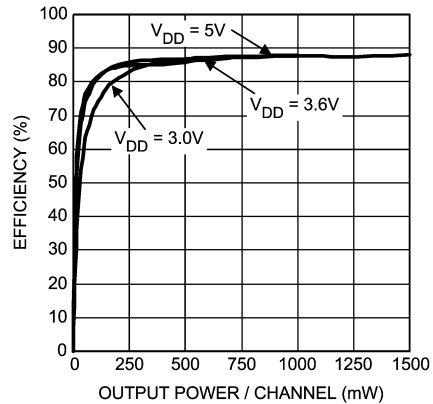

202001E3

Power Dissipation vs Output Power
Speaker Mode
 $R_L = 4\Omega$, $f = 1kHz$

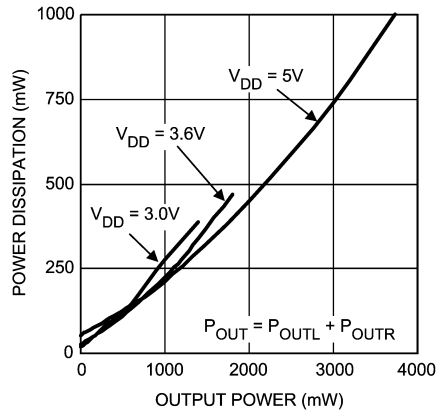

20200139

Typical Performance Characteristics (Continued)

**Power Dissipation vs Output Power
Speaker Mode
 $R_L = 8\Omega, f = 1\text{kHz}$**

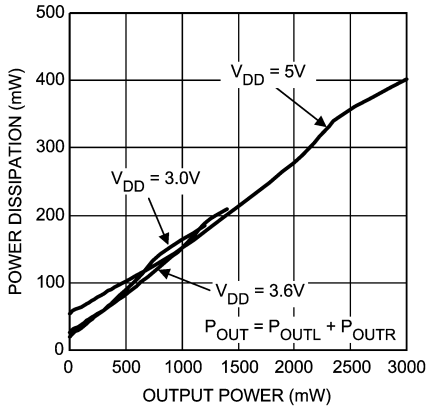

**Power Dissipation vs Output Power
OCL Headphone Mode
 $R_L = 16\Omega, f = 1\text{kHz}$**

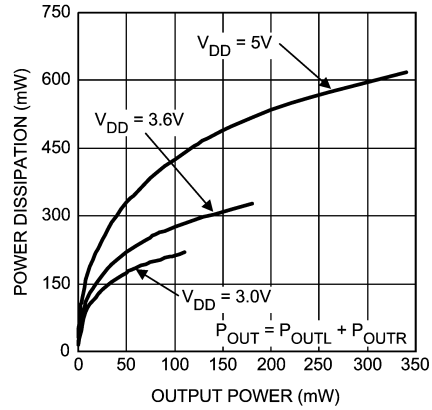

**Power Dissipation vs Output Power
OCL Headphone Mode
 $R_L = 32\Omega, f = 1\text{kHz}$**

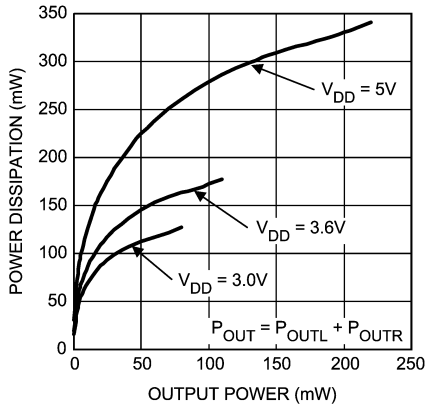

**Power Dissipation vs Output Power
CC Headphone Mode
 $R_L = 16\Omega, f = 1\text{kHz}$**

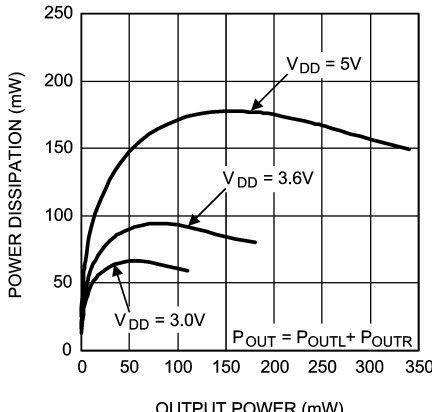

**Power Dissipation vs Output Power
CC Headphone Mode
 $R_L = 32\Omega, f = 1\text{kHz}$**

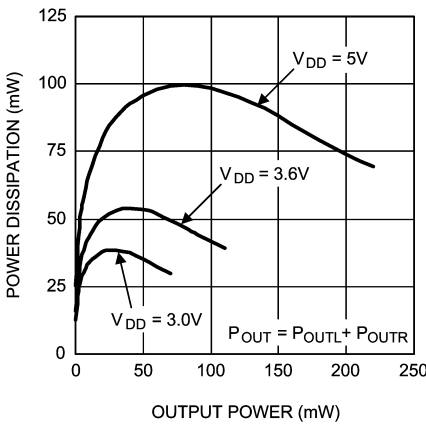

**Output Power vs Supply Voltage
Speaker Mode
 $R_L = 4\Omega, f = 1\text{kHz}$**

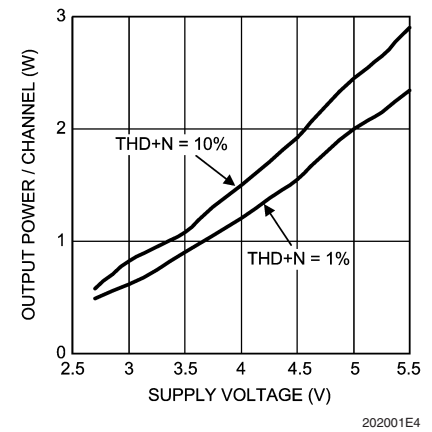

Typical Performance Characteristics (Continued)

**Output Power vs Supply Voltage
Speaker Mode
 $R_L = 8\Omega, f = 1\text{kHz}$**

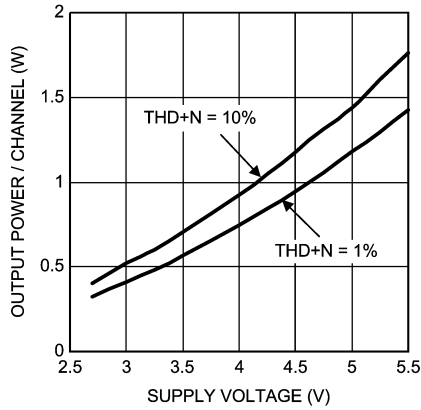

**Output Power vs Supply Voltage
OCL Headphone Mode
 $R_L = 16\Omega, f = 1\text{kHz}$**

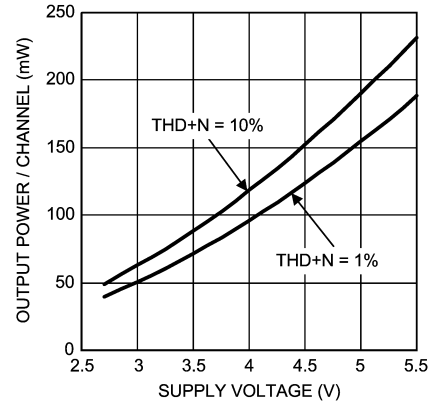

**Output Power vs Supply Voltage
OCL Headphone Mode
 $R_L = 32\Omega, f = 1\text{kHz}$**

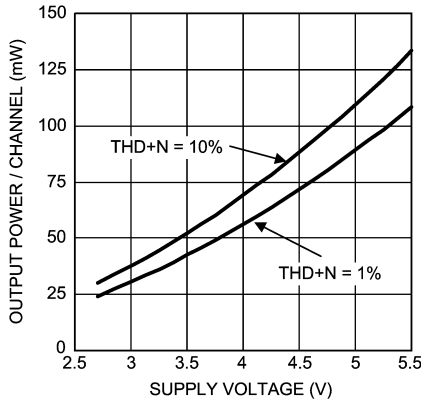

**Output Power vs Supply Voltage
CC Headphone Mode
 $R_L = 16\Omega, f = 1\text{kHz}$**

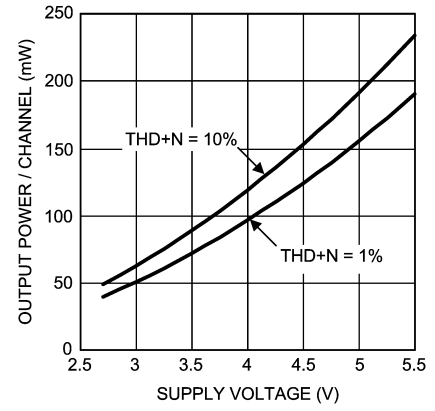

**Output Power vs Supply Voltage
CC Headphone Mode
 $R_L = 32\Omega, f = 1\text{kHz}$**

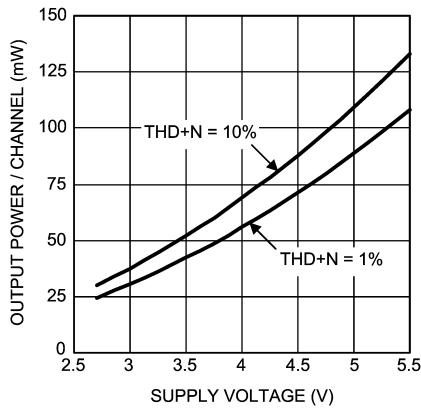

**CMRR vs Frequency
Speaker Mode, Differential Input
 $V_{DD} = 3.6\text{V}, V_{CM} = 1\text{V}_{P-P}, R_L = 8\Omega, f = 1\text{kHz}$**

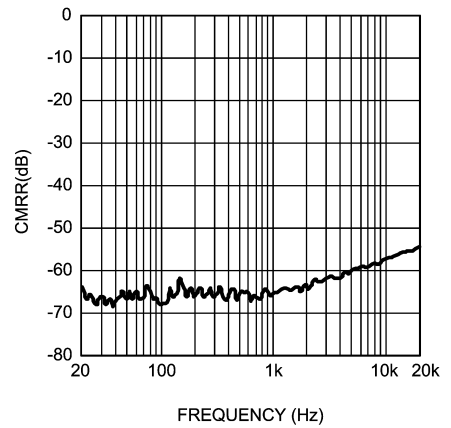

Typical Performance Characteristics (Continued)

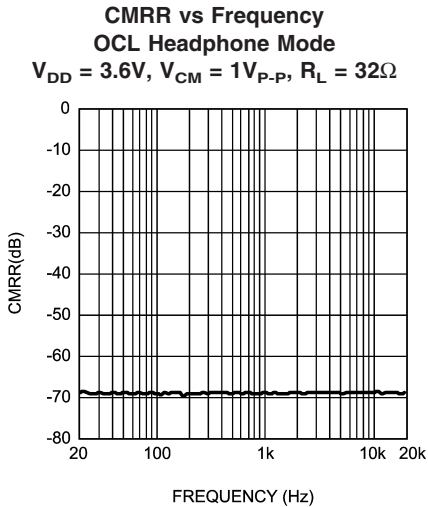

202001J9

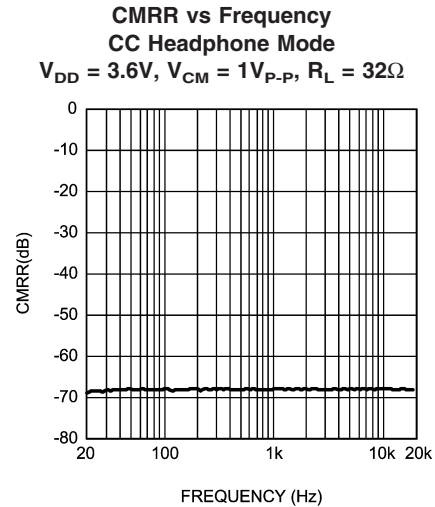

202001K3

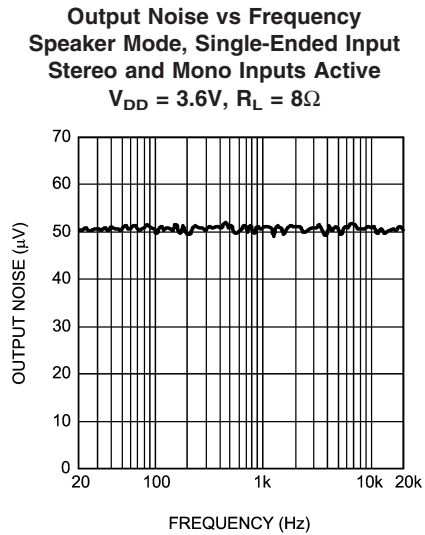

202001K0

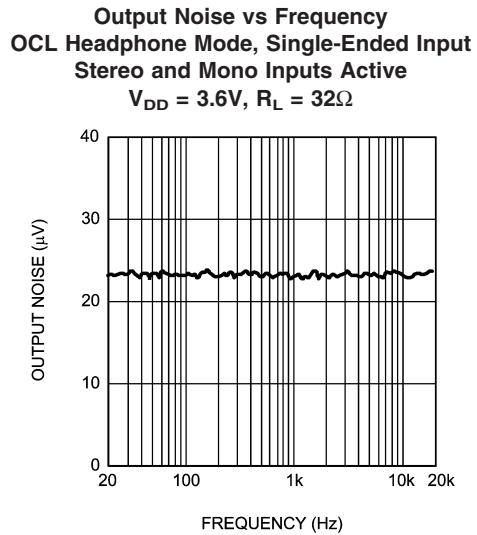

202001K1

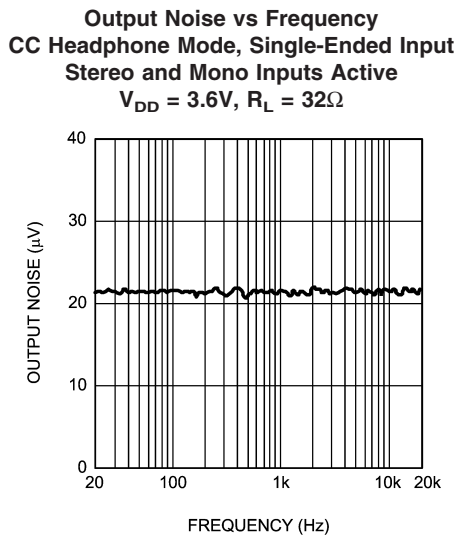

202001K2

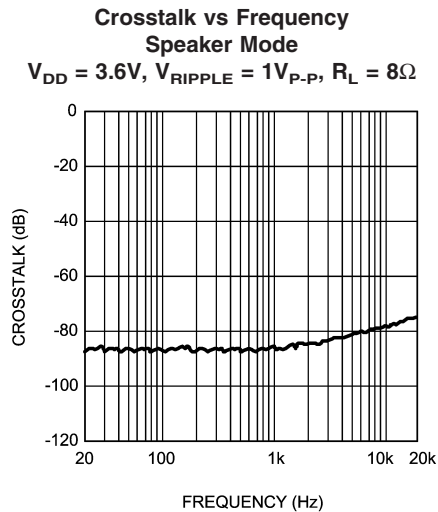

20200110

Typical Performance Characteristics (Continued)

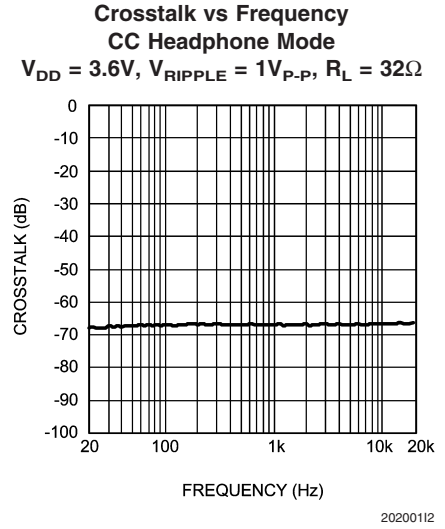
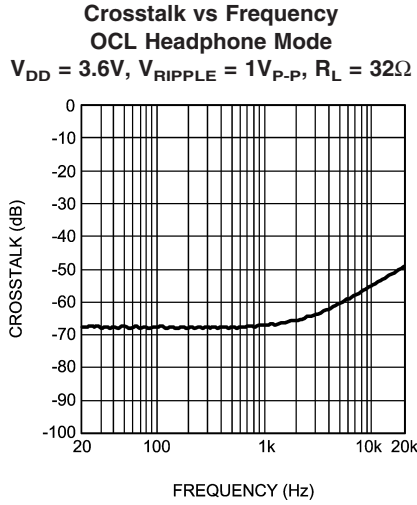

Supply Current vs Supply Voltage
Speaker Mode, No Load

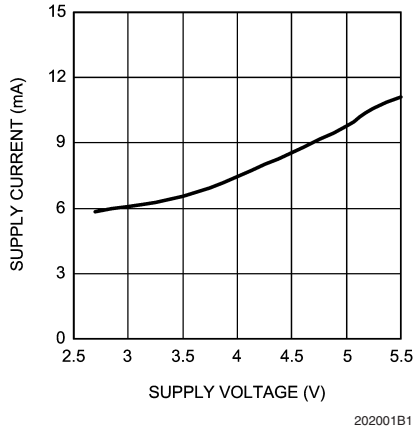

Supply Current vs Supply Voltage
OCL Headphone Mode, No Load

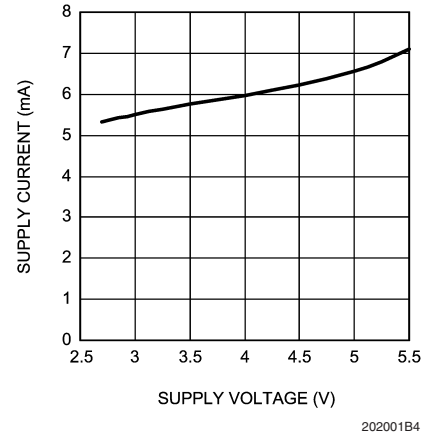

Supply Current vs Supply Voltage
CC Headphone Mode, No Load

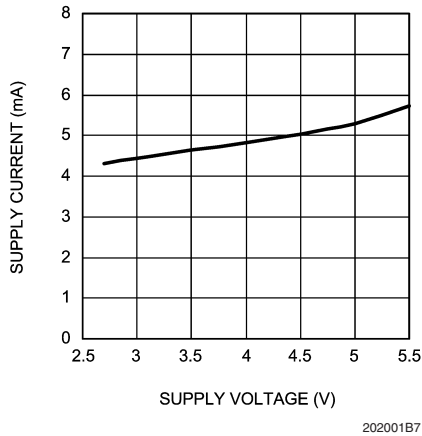

Supply Current vs Supply Voltage
Speaker and OCL Headphone Mode, No Load

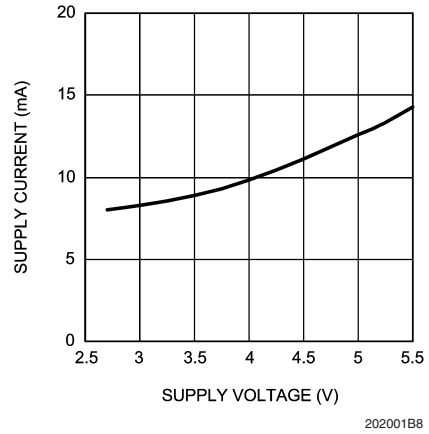

Typical Performance Characteristics (Continued)

Supply Current vs Supply Voltage Shutdown Mode, No Load

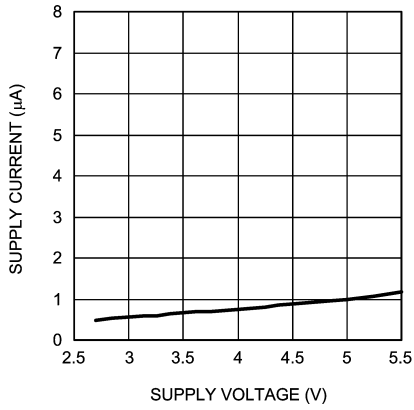

202001B9

Turn-On OCL Headphone Mode

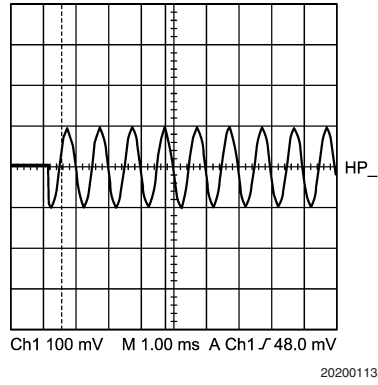

20200113

Turn-Off OCL Headphone Mode

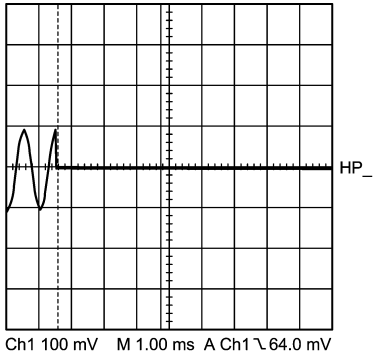

20200114

Turn-On CC Headphone Mode

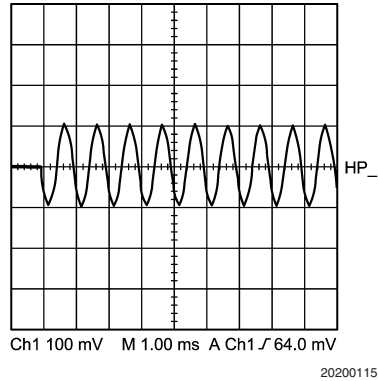

20200115

Turn-Off CC Headphone Mode

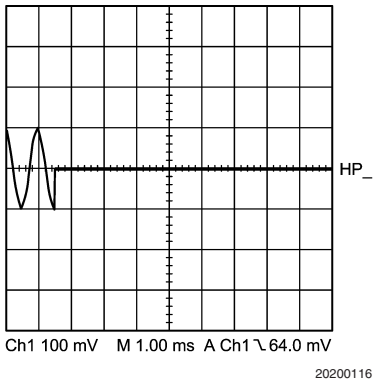

20200116

Application Information

I²C COMPATIBLE INTERFACE

The LM4949 is controlled through an I²C compatible serial interface that consists of two wires; clock (SCL) and data (SDA). The clock line is uni-directional. The data line is bi-directional (open-collector) although the LM4949 does not

write to the I²C bus. The maximum clock frequency specified by the I²C standard is 400kHz.

To avoid an address conflict with another device on the I²C bus, the LM4949 address is determined by the ADR pin, the state of ADR determines address bit A1 (Table 2). When ADR = 0, the address is 1111 1000. When ADR = 1 the device address is 1111 1010.

TABLE 2. Device Address

ADR	A7	A6	A5	A4	A3	A2	A1	A0
X	1	1	1	1	1	0	X	0
0	1	1	1	1	1	0	0	0
1	1	1	1	1	1	0	1	0

BUS FORMAT

The I²C bus format is shown in Figure 2. The “start” signal is generated by lowering the data signal while the clock is high. The start signal alerts all devices on the bus that a device address is being written to the bus.

The 8-bit device address is written to the bus next, most significant bit first. The data is latched in on the rising edge of the clock. Each address bit must be stable while the clock is high.

After the last address bit is sent, the master device releases the data line, during which time, an acknowledge clock pulse

is generated. If the LM4949 receives the address correctly, then the LM4949 pulls the data line low, generating an acknowledge bit (ACK).

Once the master device has registered the ACK bit, the 8-bit register address/data word is sent. Each data bit should be stable while the clock level is high. After the 8-bit word is sent, the LM4949 sends another ACK bit. Following the acknowledgement of the data word, the master device issues a “stop” bit, allowing SDA to go high while the clock signal is high.

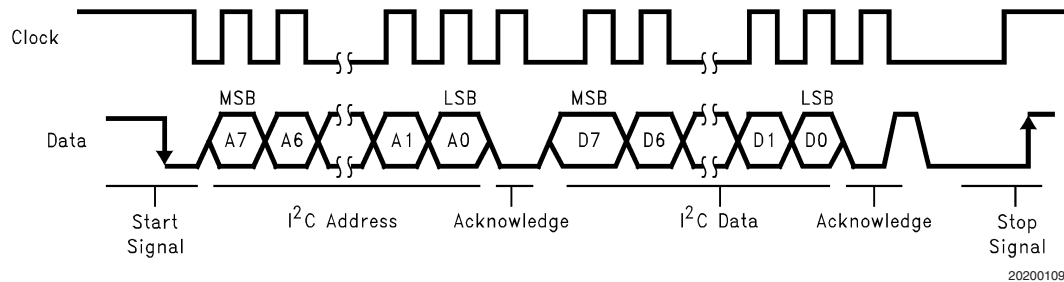

FIGURE 2. I²C Bus Format

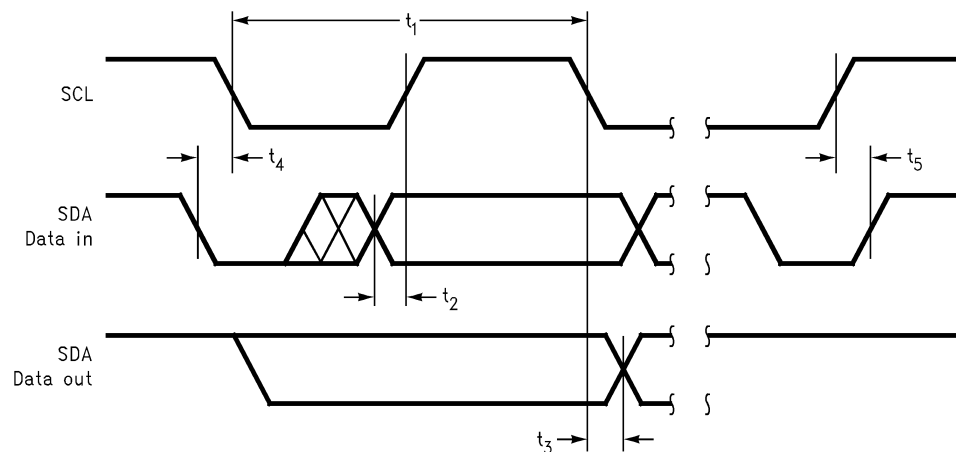

FIGURE 3. I²C Timing Diagram

Application Information (Continued)

TABLE 3. I²C Control Registers

REGISTER	REGISTER NAME	D7	D6	D5	D4	D3	D2	D1	D0
0.0	Shutdown Control	0	0	0	0	0	OCL_LGC *	OCL *	PWR_ON
0.1	Stereo Input Mode Control	0	0	0	1	L1_INSEL	L2_INSEL	SDB_HPSEL	SDB_MUXSEL
1	Speaker Output Mux Control	0	0	1	LS_XSEL	LSR_MSEL	LSR_SSEL	LSL_MSEL	LSL_SSEL
2	Headphone Output Mux Control	0	1	0	HP_XSEL	HPR_MSEL	HPR_SSEL	HPL_MSEL	HPL_SSEL
3.0	Output On/Off Control	0	1	1	0	HPR_ON	HPL_ON	LSR_ON	LSL_ON
3.1	Reserved	0	1	1	1	RESERVED	RESERVED	RESERVED	RESERVED
4.0	Headphone Output Stage Gain Control	1	0	0	0	HPG1	HPG0	RESERVED	RESERVED
4.1	Speaker Output Stage Gain Control	1	0	0	1	LSRG1	LSRG0	LSLG1	LSLG0
5	Mono Input Gain Control	1	0	1	MG4	MG3	MG2	MG1	MG0
6	Left Input Gain Control	1	1	0	LG4	LG3	LG2	LG1	LG0
7	Right Input Gain Control	1	1	1	RG4	RG3	RG2	RG1	RG0

* Note: OCL_LGC = 1 and OCL = 1 at the same time is not allowed.

Application Information (Continued)

GENERAL AMPLIFIER FUNCTION

Class D Amplifier

The LM4949 features a high-efficiency, filterless, Class D stereo amplifier. The LM4949 Class D amplifiers feature a filterless modulation scheme, the differential outputs of each channel switch at 300kHz, from V_{DD} to GND. When there is no input signal applied, the two outputs ($_{LS+}$ and $_{LS-}$) switch with a 50% duty cycle, with both outputs in phase. Because the outputs of the LM4949 are differential, the two signals cancel each other. This results in no net voltage across the speaker, thus no load current during the idle state, conserving power.

When an input signal is applied, the duty cycle (pulse width) changes. For increasing output voltages, the duty cycle of $_{LS+}$ increases, while the duty cycle of $_{LS-}$ decreases. For decreasing output voltages, the converse occurs, the duty cycle of $_{LS-}$ increases while the duty cycle of $_{LS+}$ decreases. The difference between the two pulse widths yields the differential output voltage.

Headphone Amplifier

The LM4949 headphone amplifier features three different operating modes, output capacitorless (OCL), capacitor-coupled (CC), and external amplifier mode.

The OCL architecture eliminates the bulky, expensive output coupling capacitors required by traditional headphone amplifiers. The LM4949 headphone section uses three amplifiers. Two amplifiers drive the headphones while the third (VOC) is set to the internally generated bias voltage (typically $V_{DD}/2$). The third amplifier is connected to the return terminal of the headphone jack. In this configuration, the signal side of the headphones are biased to $V_{DD}/2$, the return is biased to $V_{DD}/2$, thus there is no net DC voltage across the head-

phone, eliminating the need for an output coupling capacitor. Removing the output coupling capacitors from the headphone signal path reduces component count, reducing system cost and board space consumption, as well as improving low frequency performance.

In OCL mode, the headphone return sleeve is biased to $V_{DD}/2$. When driving headphones, the voltage on the return sleeve is not an issue. However, if the headphone output is used as a line out, the $V_{DD}/2$ can conflict with the GND potential that a line-in would expect on the return sleeve. When the return of the headphone jack is connected to GND, the VOC amplifier of the LM4949 detects an output short circuit condition and is disabled, preventing damage to the LM4949, and allowing the headphone return to be biased at GND.

Capacitor Coupled Headphone Mode

In capacitor coupled (CC) mode, the VOC pin is disabled, and the headphone outputs are coupled to the jack through series capacitors, allowing the headphone return to be connected to GND (Figure 4). In CC mode, the LM4949 requires output coupling capacitors to block the DC component of the amplifier output, preventing DC current from flowing to the load. The output capacitor and speaker impedance form a high pass filter with a -3dB roll-off determined by:

$$f_{-3dB} = 1 / 2\pi R_L C_{OUT}$$

Where R_L is the headphone impedance, and C_{OUT} is the output coupling capacitor. Choose C_{OUT} such that f_{-3dB} is well below the lowest frequency of interest. Setting f_{-3dB} too high results in poor low frequency performance. Select capacitor dielectric types with low ESR to minimize signal loss due to capacitor series resistance and maximize power transfer to the load.

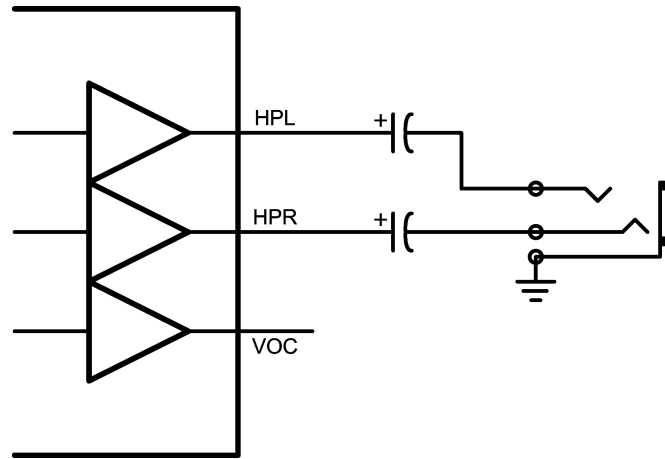

20200105

FIGURE 4. Capacitor Coupled Headphone Mode

External Headphone Amplifier

The LM4949 features the ability to drive and control a separate headphone amplifier for applications that require a True Ground headphone output (Figure 5). Configure the LM4949 into external headphone amplifier mode by setting bit D2 (OCL_LGC) in register 0.0 to 1 and bit D1 (OCL) to 0. In this mode the VOC output becomes a logic output used to drive

the shutdown input of the external amplifier. The output level of VOC is controlled by bits D1 (SDB_HPSEL) and D2 (SDB_MUXSEL) in register 0.1. SDB_MUXSEL determines the source of the VOC control signal. With SDB_MUXSEL = 0, the VOC signal comes from the internal start-up circuitry of the LM4949. This allows the external headphone amplifier to be turned on and off simultaneously with the LM4949.

Application Information (Continued)

I²C bus, bit D1. With SDB_HPSEL = 0, VOC is a logic low, with SDB_HPSEL = 1, VOC is a logic high.

When SDB_MUXSEL = 1, the VOC signal comes from the

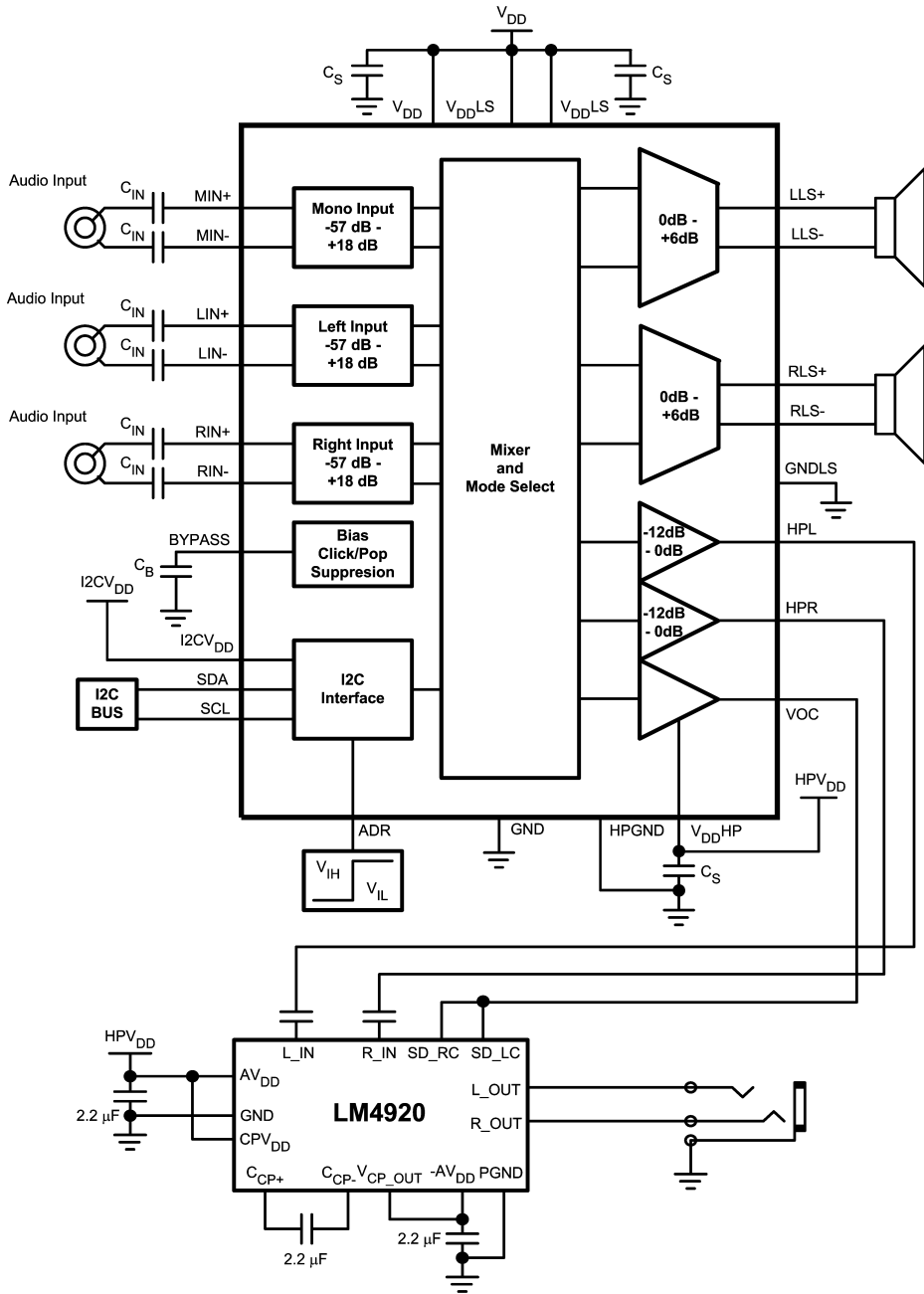

202001C8

FIGURE 5. Driving an External Headphone Amplifier

Application Information (Continued)

Single-Ended Input

The left and right stereo inputs of the LM4949 can be configured for single-ended sources (Figure 6). In single-ended input mode, the LM4949 can accept up to 4 different single-

ended audio sources. Set bits L1_INSEL = 1 and L2_INSEL = 0 to use the RIN+ and LIN+ inputs. Set L1_INSEL = 0 and L2_INSEL = 1 to use the RIN- and LIN- inputs. Set L1_INSEL = L2_INSEL = 1 to use both input pairs. Table 4 shows the single ended input combinations.

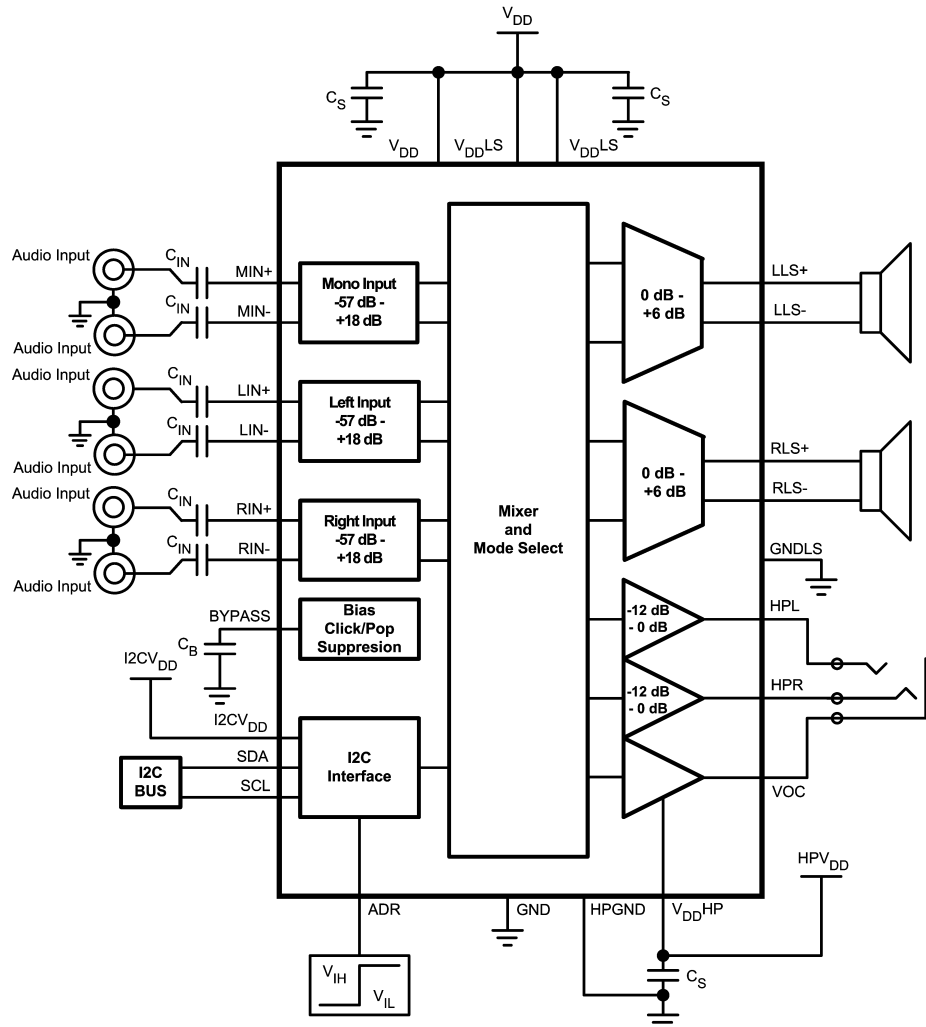

202001C9

FIGURE 6. Single-Ended Input Configuration

TABLE 4. Single-Ended Stereo Input Modes

INPUT MODE	L1_INSEL	L2_INSEL	INPUT DESCRIPTION
0	0	0	Fully Differential Input Mode
1	0	1	Single-ended input. RIN- and LIN- selected
2	1	0	Single-ended input. RIN+ and LIN+ selected
3	1	1	Single-ended input. RIN+ mixed with RIN- and LIN+ mixed with LIN-

Application Information (Continued)

Input Mixer / Multiplexer

The LM4949 includes a comprehensive mixer/multiplexer controlled through the I2C interface. The mixer/multiplexer allows any input combination to appear on any output of the LM4949. Control bits LSR_SSEL and LSL_SSEL (loudspeakers), and HPR_SSEL and HPL_SSEL (headphones) select the individual stereo input channels; for example, LSR_SSEL = 1 outputs the right channel stereo input on the right channel loudspeaker, while LSL_SSEL = 1 outputs the left channel stereo input on the left channel loudspeaker. Control bits LSR_MSEL and LSL_MSEL (loudspeaker), and HPR_MSEL and HPR_LSEL (headphones) direct the mono input to the selected output. Setting HPR_MSEL = 1 outputs

the mono input on the right channel headphone. Control bits LS_XSEL (loudspeaker) and HP_XSEL (headphone) selects both stereo input channels and directs the signals to the opposite outputs, for example, LS_XSEL = 1 outputs the right channel stereo input on the left channel loudspeaker, while the left channel stereo input is output on the right channel loudspeaker. Setting __XSEL = selects both stereo inputs simultaneously, unlike the __SSEL controls which select the stereo input channels individually.

Multiple input paths can be selected simultaneously. Under these conditions, the selected inputs are mixed together and output on the selected channel. Tables 5 and 6 show how the input signals are mixed together for each possible input selection combination.

TABLE 5. Loudspeaker Multiplexer Control

LS MODE	LS_XSEL	LSR_MSEL/ LSL_MSEL	LSR_SSEL/ LSL_SSEL	LEFT CHANNEL OUTPUT	RIGHT CHANNEL OUTPUT
0		0	0	MUTE	MUTE
1	0	1	0	MONO	MONO
2	0	0	1	LEFT (DIFF)/ /LIN+/LIN-/ (LIN+ - LIN-)	RIGHT (DIFF)/ /RIN+/RIN-/ (RIN+ - RIN-)
3	0	1	1	MONO + LEFT (DIFF)/ /LIN+/LIN-/ (LIN+ - LIN-)	MONO + RIGHT (DIFF)/ /RIN+/RIN-/ (RIN+ - RIN-)
4	1	0	1	LEFT (DIFF)/ /LIN+/LIN-/ (LIN+ - LIN-) + RIGHT (DIFF)/ /RIN+/RIN-/ (RIN+ - RIN-)	LEFT (DIFF)/ /LIN+/LIN-/ (LIN+ - LIN-) + RIGHT (DIFF)/ /RIN+/RIN-/ (RIN+ - RIN-)
5	1	1	1	MONO + LEFT (DIFF)/ /LIN+/LIN-/ (LIN+ - LIN-) + RIGHT (DIFF)/ /RIN+/RIN-/ (RIN+ - RIN-)	MONO + LEFT (DIFF)/ /LIN+/LIN-/ (LIN+ - LIN-) + RIGHT (DIFF)/ /RIN+/RIN-/ (RIN+ - RIN-)

TABLE 6. Headphone Multiplexer Control

HP MODE	HP_XSEL	HPR_MSEL/ HPL_MSEL	HPR_SSEL/ HPL_SSEL	LEFT CHANNEL OUTPUT	RIGHT CHANNEL OUTPUT
0		0	0	MUTE	MUTE
1	0	1	0	MONO	MONO
2	0	0	1	LEFT (DIFF)/ /LIN+/LIN-/ (LIN+ - LIN-)	RIGHT (DIFF)/ /RIN+/RIN-/ (RIN+ - RIN-)
3	0	1	1	MONO + LEFT (DIFF)/ /LIN+/LIN-/ (LIN+ - LIN-)	MONO + RIGHT (DIFF)/ /RIN+/RIN-/ (RIN+ - RIN-)
4	1	0	1	LEFT (DIFF)/ /LIN+/LIN-/ (LIN+ - LIN-) + RIGHT (DIFF)/ /RIN+/RIN-/ (RIN+ - RIN-)	LEFT (DIFF)/ /LIN+/LIN-/ (LIN+ - LIN-) + RIGHT (DIFF)/ /RIN+/RIN-/ (RIN+ - RIN-)
5	1	1	1	MONO + LEFT (DIFF)/ /LIN+/LIN-/ (LIN+ - LIN-) + RIGHT (DIFF)/ /RIN+/RIN-/ (RIN+ - RIN-)	MONO + LEFT (DIFF)/ /LIN+/LIN-/ (LIN+ - LIN-) + RIGHT (DIFF)/ /RIN+/RIN-/ (RIN+ - RIN-)

Power Supplies

The LM4949 uses different supplies for each portion of the device, allowing for the optimum combination of headroom, power dissipation and noise immunity. The speaker amplifier gain stage is powered from VDD, while the output stage is powered from VDDL. The headphone amplifiers, input amplifiers and volume control stages are powered from VDDHP. The separate power supplies allow the speakers to operate

from a higher voltage for maximum headroom, while the headphones operate from a lower voltage, improving power dissipation. VDDHP may be driven by a linear regulator to further improve performance in noisy environments. The I²C portion if powered from I²CVDD, allowing the I²C portion of the LM4949 to interface with lower voltage digital controllers.

Application Information (Continued)

Shutdown Function

The LM4949 features five shutdown modes, configured through the I²C interface. Bit D0 (PWR_ON) in the Shutdown Control register shuts down/turns on the entire device. Set PWR_ON = 1 to enable the LM4949, set PWR_ON 0 to disable the device. Bits D0 – D3 in the Output On/Off Control shutdown/turn on the individual channels. HPR_ON (D3) controls the right channel headphone output, HPL_ON (D2) controls the left channel headphone output, LSR_ON (D1) controls the right channel loudspeaker output, and LRL_ON (D0) controls the left channel loudspeaker output. The PWR_ON bit takes precedence over the individual channel controls.

Audio Amplifier Gain Setting

The each channel of the LM4949 has two separate gain stages. Each input stage features a 32 step volume control

with a range of -57dB to +18dB (Table 7). Each speaker output stage has 4 gain settings (Table 8); 0dB, 2dB, 4dB, and 6dB when either a fully differential signal or two single ended signals are applied on the _IN+ and _IN- pins; and 6dB, 8dB, 10dB and 12dB in single-ended input mode with only one signal applied. The headphone gain is not affected by the input mode. Each headphone output stage has 3 gain settings (Table 9), 0dB, -6dB, and -12dB. This allows for a maximum separation of 24dB between the speaker and headphone outputs when both are active.

Calculate the total gain of a given signal path as follows:

$$A_{VOL} + A_{OS} = A_{TOTAL}$$

Where A_{VOL} is the volume control level, A_{OS} is the gain setting of the output stage, and A_{TOTAL} is the total gain for the signal path.

Application Information (Continued)

TABLE 7. 32 Step Volume Control

Volume Step	MG4/LG4/RG4	MG3/LG3/RG3	MG2/LG2/RG2	MG1/LG1/RG1	MG0/LG0/RG0	Gain (dB)
1	0	0	0	0	0	-57
2	0	0	0	0	1	-49
3	0	0	0	1	0	-42
4	0	0	0	1	1	-34.5
5	0	0	1	0	0	-30.5
6	0	0	1	0	1	-27
7	0	0	1	1	0	-24
8	0	0	1	1	1	-21
9	0	1	0	0	0	-18
10	0	1	0	0	1	-15
11	0	1	0	1	0	-13.5
12	0	1	0	1	1	-12
13	0	1	1	0	0	-10.5
14	0	1	1	0	1	-9
15	0	1	1	1	0	-7.5
16	0	1	1	1	1	-6
17	1	0	0	0	0	-4.5
18	1	0	0	0	1	-3
19	1	0	0	1	0	-1.5
20	1	0	0	1	1	0
21	1	0	1	0	0	1.5
22	1	0	1	0	1	3
23	1	0	1	1	0	4.5
24	1	0	1	1	1	6
25	1	1	0	0	0	7.5
26	1	1	0	0	1	9
27	1	1	0	1	0	10.5
28	1	1	0	1	1	12
29	1	1	1	0	0	13.5
30	1	1	1	0	1	15
31	1	1	1	1	0	16.5
32	1	1	1	1	1	18

TABLE 8. Loudspeaker Gain Setting

LSRG1/LSLG1	LSRG0/LSLG0	Gain (dB)	
		_IN+ ≠ _IN-	_IN+ = _IN-
0	0	12	6
0	1	10	4
1	0	8	2
1	1	6	0

TABLE 9. Headphone Gain Setting

HPG1	HPG0	Gain (dB)
0	0	0
0	1	-6
1	0	-12

Application Information (Continued)

Differential Audio Amplifier Configuration

As logic supply voltages continue to shrink, system designers increasingly turn to differential signal handling to preserve signal to noise ratio with decreasing voltage swing. The LM4949 can be configured as a fully differential amplifier, amplifying the difference between the two inputs. The advantage of the differential architecture is any signal component that is common to both inputs is rejected, improving common-mode rejection (CMRR) and increasing the SNR of the amplifier by 6dB over a single-ended architecture. The improved CMRR and SNR of a differential amplifier reduce sensitivity to ground offset related noise injection, especially important in noisy applications such as cellular phones. Driving the LM4949 differentially also allows the inputs to be DC coupled, eliminating two external capacitors per channel. Set bits L1_INSEL and L2_INSEL = 0 for differential input mode. The left and right stereo inputs have selectable differential or single-ended input modes, while the mono input is always differential.

Single-Ended Audio Amplifier Configuration

In single-ended input mode, the audio sources must be capacitively coupled to the LM4949. With LIN+ ≠ LIN- and RIN+ ≠ RIN-, the loud speaker gain is 6dB more than in differential input mode, or when LIN+ = LIN- and RIN+ = RIN-. The headphone gain does not change. The mono input channel is not affected by L1_INSEL and L2_INSEL, and is always configured as a differential input.

Power Dissipation and Efficiency

The major benefit of Class D amplifiers is increased efficiency versus Class AB. The efficiency of the LM4949 speaker amplifiers is attributed to the output transistors' region of operation. The Class D output stage acts as current steering switches, consuming negligible amounts of power compared to their Class AB counterparts. Most of the power loss associated with the output stage is due to the IR loss of the MOSFET on-resistance, along with the switching losses due to gate charge.

The maximum power dissipation per headphone channel in Capacitor-Coupled mode is given by:

$$P_{\text{DMAX}} = V_{\text{DD}}^2 / 2\pi^2 R_L$$

In OCL mode, the maximum power dissipation per headphone channel increases due to the use of a third amplifier as a buffer. The power dissipation is given by:

$$P_{\text{DMAX}} = V_{\text{DD}}^2 / \pi^2 R_L$$

PROPER SELECTION OF EXTERNAL COMPONENTS

Audio Amplifier Power Supply Bypassing / Filtering

Proper power supply bypassing is critical for low noise performance and high PSRR. Place the supply bypass capaci-

tors as close to the device as possible. Typical applications employ a voltage regulator with 10μF and 0.1μF bypass capacitors that increase supply stability. These capacitors do not eliminate the need for bypassing of the LM4949 supply pins. A 1μF ceramic capacitor placed close to each supply pin is recommended.

Bypass Capacitor Selection

The LM4949 generates a $V_{\text{DD}}/2$ common-mode bias voltage internally. The BYPASS capacitor, C_B , improves PSRR and THD+N by reducing noise at the BYPASS node. Use a 1μF capacitor, placed as close to the device as possible for C_B .

Audio Amplifier Input Capacitor Selection

Input capacitors, C_{IN} , in conjunction with the input impedance of the LM4949 forms a high pass filter that removes the DC bias from an incoming signal. The AC-coupling capacitor allows the amplifier to bias the signal to an optimal DC level. Assuming zero source impedance, the -3dB point of the high pass filter is given by:

$$f_{-3\text{dB}} = 1 / 2\pi R_{\text{IN}} C_{\text{IN}}$$

Choose C_{IN} such that $f_{-3\text{dB}}$ is well below the lowest frequency of interest. Setting $f_{-3\text{dB}}$ too high affects the low-frequency response of the amplifier. Use capacitors with low voltage coefficient dielectrics, such as tantalum or aluminum electrolytic. Capacitors with high-voltage coefficients, such as ceramics, may result in increased distortion at low frequencies. Other factors to consider when designing the input filter include the constraints of the overall system. Although high fidelity audio requires a flat frequency response between 20Hz and 20kHz, portable devices such as cell phones may only concentrate on the frequency range of the spoken human voice (typically 300Hz to 4kHz). In addition, the physical size of the speakers used in such portable devices limits the low frequency response; in this case, frequencies below 150Hz may be filtered out.

PCB LAYOUT GUIDELINES

Minimize trace impedance of the power, ground and all output traces for optimum performance. Voltage loss due to trace resistance between the LM4949 and the load results in decreased output power and efficiency. Trace resistance between the power supply and GND of the LM4949 has the same effect as a poorly regulated supply, increased ripple and reduced peak output power. Use wide traces for power-supply inputs and amplifier outputs to minimize losses due to trace resistance, as well as route heat away from the device. Proper grounding improves audio performance, minimizes crosstalk between channels and prevents switching noise from interfering with the audio signal. Use of power and ground planes is recommended.

Place all digital components and digital signal traces as far as possible from analog components and traces. Do not run digital and analog traces in parallel on the same PCB layer.

Revision History

Rev	Date	Description
1.0	09/06/06	Initial release.
1.1	09/27/06	Fixed some of the Typical Performance Curves.

Physical Dimensions inches (millimeters) unless otherwise noted

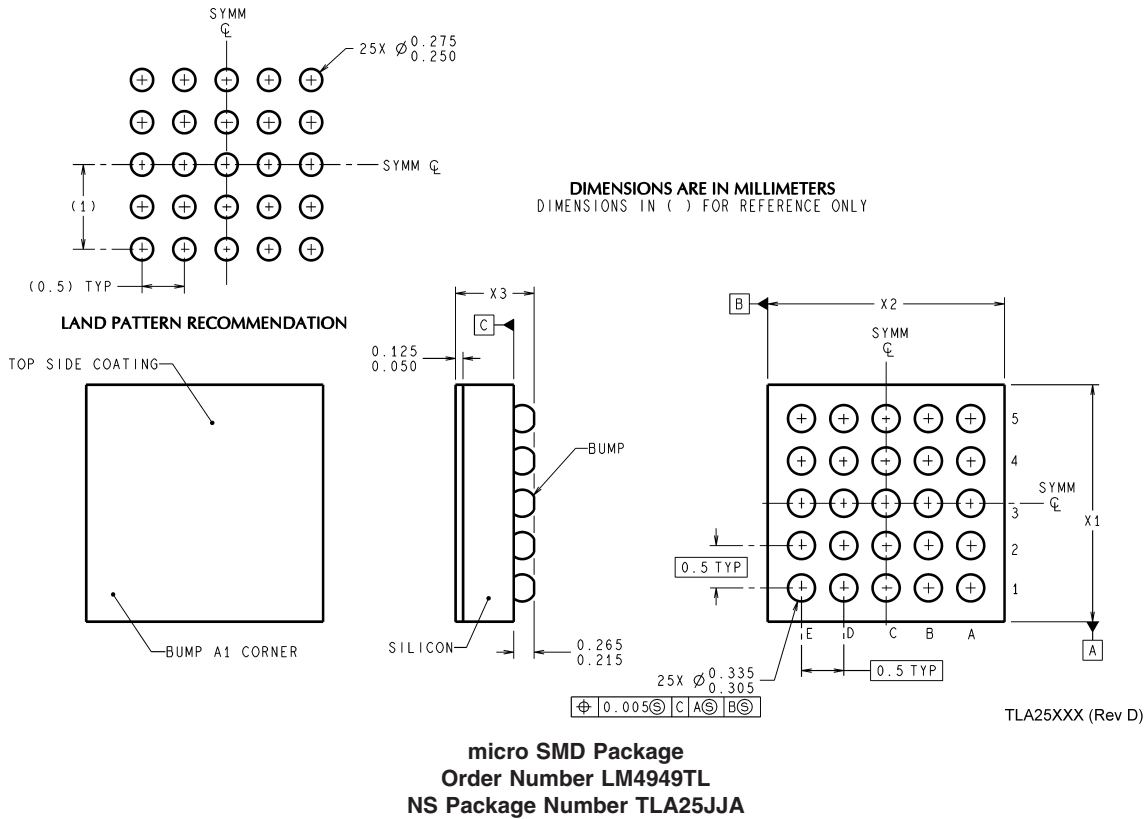

National does not assume any responsibility for use of any circuitry described, no circuit patent licenses are implied and National reserves the right at any time without notice to change said circuitry and specifications.

For the most current product information visit us at www.national.com.

LIFE SUPPORT POLICY

NATIONAL'S PRODUCTS ARE NOT AUTHORIZED FOR USE AS CRITICAL COMPONENTS IN LIFE SUPPORT DEVICES OR SYSTEMS WITHOUT THE EXPRESS WRITTEN APPROVAL OF THE PRESIDENT AND GENERAL COUNSEL OF NATIONAL SEMICONDUCTOR CORPORATION. As used herein:

1. Life support devices or systems are devices or systems which, (a) are intended for surgical implant into the body, or (b) support or sustain life, and whose failure to perform when properly used in accordance with instructions for use provided in the labeling, can be reasonably expected to result in a significant injury to the user.
2. A critical component is any component of a life support device or system whose failure to perform can be reasonably expected to cause the failure of the life support device or system, or to affect its safety or effectiveness.

BANNED SUBSTANCE COMPLIANCE

National Semiconductor follows the provisions of the Product Stewardship Guide for Customers (CSP-9-111C2) and Banned Substances and Materials of Interest Specification (CSP-9-111S2) for regulatory environmental compliance. Details may be found at: www.national.com/quality/green.

Lead free products are RoHS compliant.

National Semiconductor
Americas Customer Support Center
Email: new.feedback@nsc.com
Tel: 1-800-272-9959

National Semiconductor
Europe Customer Support Center
Fax: +49 (0) 180-530 85 86
Email: europa.support@nsc.com
Deutsch Tel: +49 (0) 69 9508 6208
English Tel: +44 (0) 870 24 0 2171
Français Tel: +33 (0) 1 41 91 8790

National Semiconductor
Asia Pacific Customer Support Center
Email: ap.support@nsc.com

National Semiconductor
Japan Customer Support Center
Fax: 81-3-5639-7507
Email: jpn.feedback@nsc.com
Tel: 81-3-5639-7560

www.national.com