

LM4951A Boomer[®] Audio Power Amplifier Series

Wide Voltage Range 1.8 Watt Audio Amplifier With Short Circuit Protection

General Description

The LM4951A is an audio power amplifier designed for applications with supply voltages ranging from 2.7V up to 9V. The LM4951A is capable of delivering 1.8W continuous average power with less than 1% THD+N into a bridge connected 8Ω load when operating from a 7.5VDC power supply.

Boomer audio power amplifiers were designed specifically to provide high quality output power with a minimal amount of external components. The LM4951A does not require bootstrap capacitors, or snubber circuits.

The LM4951A features a low-power consumption active-low shutdown mode. Additionally, the LM4951A features an internal thermal shutdown protection mechanism and short circuit protection.

The LM4951A contains advanced pop & click circuitry that eliminates noises which would otherwise occur during turn-on and turn-off transitions.

The LM4951A is unity-gain stable and can be configured by external gain-setting resistors.

Key Specifications

■ Wide Voltage Range	2.7V to 9V
■ Quiescent Power Supply Current ($V_{DD} = 7.5V$)	2.5mA (typ)
■ Power Output BTL at 7.5V, 1% THD	1.8W (typ)
■ Shutdown Current	0.01μA (typ)
■ Fast Turn on Time	25ms (typ)

Features

- Pop & click circuitry eliminates noise during turn-on and turn-off transitions
- Wide supply voltage range: 2.7V to 9V
- Low current, active-low shutdown mode
- Low quiescent current
- Thermal shutdown protection
- Short circuit protection
- Unity-gain stable
- External gain configuration capability

Applications

- Portable devices
- Cell phones
- Laptop computers
- Computer speaker systems
- MP3 player speakers

Typical Application

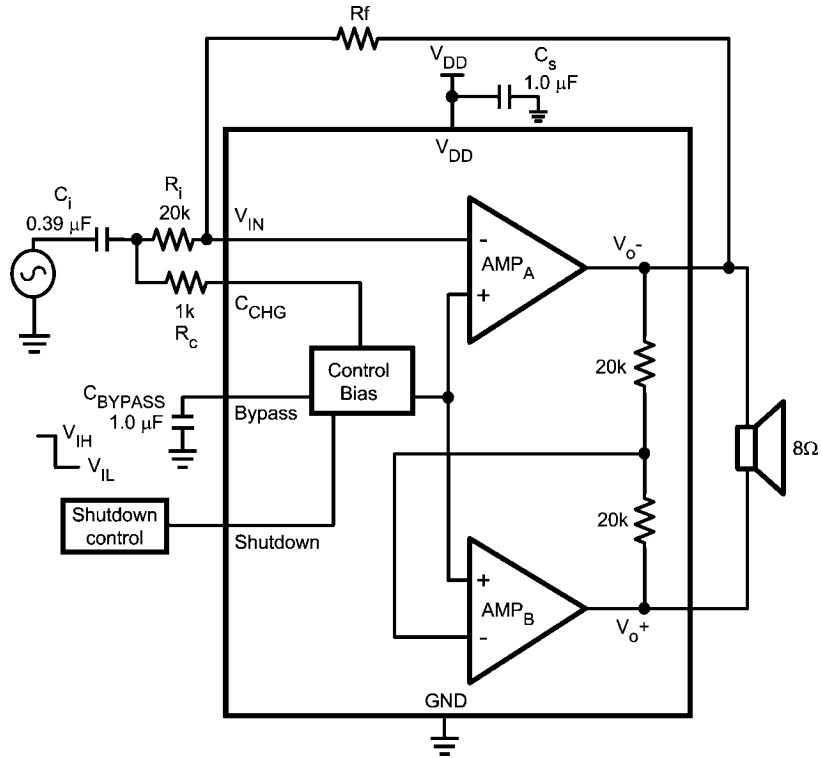

30057814

FIGURE 1. Typical Bridge-Tied-Load (BTL) Audio Amplifier Application Circuit

Connection Diagrams

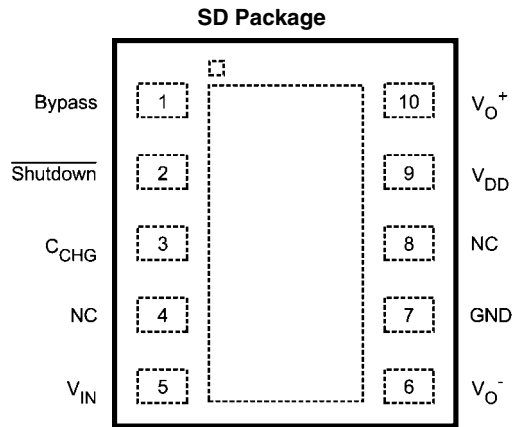

Top View
Order Number LM4951ASD
See NS Package Number SDC10A

SD Package Marking

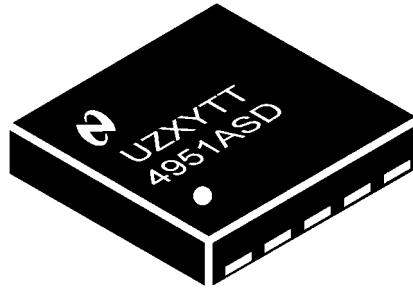

Top View
U = Fab site code
Z = Assembly plant code
XY = Date code
TT = Die traceability
4951A = LM4951A
SD = Package code

30057831

Ordering Information

Order Number	Package	Package DWG #	Transport Media	MSL Level	Green Status	Features
LM4951ASD	10 Lead LLP	SDC10A	1000 units in Tape and Reel	1	RoH and no Sb/Br	
LM4951ASDX	10 Lead LLP	SDC10A	4500 units in Tape and Reel	1	RoH and no Sb/Br	

TABLE 1. Pin Name and Function

Pin Number	Name	Function	Type
1	Bypass	$\frac{1}{2}$ supply reference voltage bypass output. See sections POWER SUPPLY BYPASSING and SELECTING EXTERNAL COMPONENTS for more information.	Analog Output
2	Shutdown	Shutdown control active low signal. A logic low voltage will put the LM4951A into Shutdown mode.	Digital Input
3	C_{CHG}	Input capacitor charge to decrease turn on time. See section Selecting A Value for R_C for more information.	Analog Output
4	NC	No connection to die. Pin can be connected to any potential.	No Connect
5	V_{IN}	Single-ended signal input pin.	Analog Input
6	V_{O-}	Inverting output of amplifier.	Analog Output
7	GND	Ground connection.	Ground
8	NC	No connection to die. Pin can be connected to any potential.	No Connect
9	V_{DD}	Power supply.	Power
10	V_{O+}	Non-Inverting output of amplifier.	Analog Output
Exposed DAP	NC	No connect. Pin must be electrically isolated (floating) or connected to GND.	No Connect

Absolute Maximum Ratings (Notes 1, 2)

If Military/Aerospace specified devices are required, please contact the National Semiconductor Sales Office/Distributors for availability and specifications.

Supply Voltage	9.5V
Storage Temperature	-65°C to +150°C
Input Voltage	-0.3V to $V_{DD} + 0.3V$
Power Dissipation (Note 3)	Internally limited
ESD Rating (Note 4)	2000V
ESD Rating (Note 5)	200V
Junction Temperature (T_{JMAX})	150°C

Thermal Resistance

$$\theta_{JA} \text{ (LLP) (Note 3)} \quad 73^\circ\text{C/W}$$

Soldering Information

See AN-1187 'Leadless Leadframe Packaging (LLP).'

Operating Ratings (Notes 1, 2)

Temperature Range

$$T_{MIN} \leq T_A \leq T_{MAX} \quad -40^\circ\text{C} \leq T_A \leq +85^\circ\text{C}$$

Supply Voltage

$$2.7V \leq V_{DD} \leq 9V$$

Electrical Characteristics $V_{DD} = 7.5V$ (Notes 1, 2)

The following specifications apply for $V_{DD} = 7.5V$, $A_{V-BTL} = 6dB$, $R_L = 8\Omega$ unless otherwise specified. Limits apply for $T_A = 25^\circ\text{C}$.

Symbol	Parameter	Conditions	LM4951A		Units (Limits)
			Typical (Note 6)	Limit (Note 7)	
I_{DD}	Quiescent Power Supply Current	$V_{IN} = 0V$, $I_O = 0A$, $R_L = 8\Omega$ BTL	2.5	4.5	mA (max)
I_{SD}	Shutdown Current	$V_{SD} = GND$ (Note 8)	0.01	5	μA (max)
V_{OS}	Output Offset Voltage		5	30	mV (max)
V_{SDIH}	Shutdown Voltage Input High			1.2	V (min)
V_{SDIL}	Shutdown Voltage Input Low			0.4	V (max)
$R_{PULLDOWN}$	Pull-down Resistor on SD pin		75	45	k Ω (min)
T_{WU}	Wake-up Time	$C_B = 1.0\mu F$	25	35	ms (max)
T_{SD}	Shutdown time	$C_B = 1.0\mu F$		10	ms (max)
TSD	Thermal Shutdown Temperature		170	150 190	$^\circ\text{C}$ (min) $^\circ\text{C}$ (max)
P_O	Output Power	THD = 1% (max); $f = 1\text{kHz}$ $R_L = 8\Omega$ Mono BTL	1.8	1.5	W (min)
THD+N	Total Harmonic Distortion + Noise	$P_O = 600\text{mW}_{RMS}$; $f = 1\text{kHz}$ $A_{V-BTL} = 6\text{dB}$	0.07	0.5	% (max)
		$P_O = 600\text{mW}_{RMS}$; $f = 1\text{kHz}$ $A_{V-BTL} = 26\text{dB}$	0.35		%
ϵ_{OS}	Output Noise	A-Weighted Filter, $R_i = R_f = 20\text{k}\Omega$ Input Referred (Note 9)	10		μV
PSRR	Power Supply Rejection Ratio	$V_{RIPPLE} = 200\text{mV}_{p-p}$, $f = 217\text{Hz}$, $C_B = 1.0\mu F$, Input Referred	66	56	dB (min)

Electrical Characteristics $V_{DD} = 3.3V$ (Notes 1, 2)

The following specifications apply for $V_{DD} = 3.3V$, $A_{V-BTL} = 6dB$, $R_L = 8\Omega$ unless otherwise specified. Limits apply for $T_A = 25^\circ\text{C}$.

Symbol	Parameter	Conditions	LM4951A		Units (Limits)
			Typical (Note 6)	Limit (Note 7)	
I_{DD}	Quiescent Power Supply Current	$V_{IN} = 0V$, $I_O = 0A$, $R_L = 8\Omega$ BTL	2.5	4.5	mA (max)
I_{SD}	Shutdown Current	$V_{SHUTDOWN} = GND$ (Note 8)	0.01	2	μA (max)
V_{OS}	Output Offset Voltage		3	30	mV (max)
V_{SDIH}	Shutdown Voltage Input High			1.2	V (min)
V_{SDIL}	Shutdown Voltage Input Low			0.4	V (max)
T_{WU}	Wake-up Time	$C_B = 1.0\mu F$	25		ms
T_{SD}	Shutdown time	$C_B = 1.0\mu F$		10	ms (max)

Symbol	Parameter	Conditions	LM4951A		Units (Limits)
			Typical (Note 6)	Limit (Note 7)	
P_O	Output Power	THD = 1% (max); $f = 1\text{kHz}$ $R_L = 8\Omega$ Mono BTL	280	230	mW (min)
THD+N	Total Harmonic Distortion + Noise	$P_O = 100\text{mW}_{\text{RMS}}$; $f = 1\text{kHz}$ $A_{\text{V-BTL}} = 6\text{dB}$	0.07	0.5	% (max)
		$P_O = 100\text{mW}_{\text{RMS}}$; $f = 1\text{kHz}$ $A_{\text{V-BTL}} = 26\text{dB}$	0.35		%
ϵ_{OS}	Output Noise	A-Weighted Filter, $R_i = R_f = 20\text{k}\Omega$ Input Referred, (Note 9)	10		μV
PSRR	Power Supply Rejection Ratio	$V_{\text{RIPPLE}} = 200\text{mV}_{\text{p-p}}$, $f = 217\text{Hz}$, $C_B = 1\mu\text{F}$, Input Referred	71	61	dB (min)

Note 1: "Absolute Maximum Ratings" indicate limits beyond which damage to the device may occur, including inoperability and degradation of device reliability and/or performance. Functional operation of the device and/or non-degradation at the *s* or other conditions beyond those indicated in the *Recommended Operating Conditions* is not implied. The *Recommended Operating Conditions* indicate conditions at which the device is functional and the device should not be operated beyond such conditions. All voltages are measured with respect to the ground pin, unless otherwise specified.

Note 2: The *Electrical Characteristics* tables list guaranteed specifications under the listed *Recommended Operating Conditions* except as otherwise modified or specified by the *Electrical Characteristics Conditions* and/or Notes. Typical specifications are estimations only and are not guaranteed.

Note 3: The maximum power dissipation must be derated at elevated temperatures and is dictated by T_{JMAX} , θ_{JA} , and the ambient temperature, T_{A} . The maximum allowable power dissipation is $P_{\text{DMAX}} = (T_{\text{JMAX}} - T_{\text{A}}) / \theta_{\text{JA}}$ or the number given in *Absolute Maximum Ratings*, whichever is lower. For the LM4951A typical application (shown in Figure 1) with $V_{\text{DD}} = 7.5\text{V}$, $R_L = 8\Omega$ mono-BTL operation the max power dissipation is 1.42W. $\theta_{\text{JA}} = 73^\circ\text{C/W}$.

Note 4: Human body model, applicable std. JESD22-A114C.

Note 5: Machine model, applicable std. JESD22-A115-A.

Note 6: Typical values represent most likely parametric norms at $T_{\text{A}} = +25^\circ\text{C}$, and at the *Recommended Operation Conditions* at the time of product characterization and are not guaranteed.

Note 7: Datasheet min/max specification limits are guaranteed by test or statistical analysis.

Note 8: Shutdown current is measured in a normal room environment. The Shutdown pin should be driven as close as possible to GND for minimum shutdown current.

Note 9: Noise measurements are dependent on the absolute values of the closed loop gain setting resistors (input and feedback resistors).

Typical Performance Characteristics

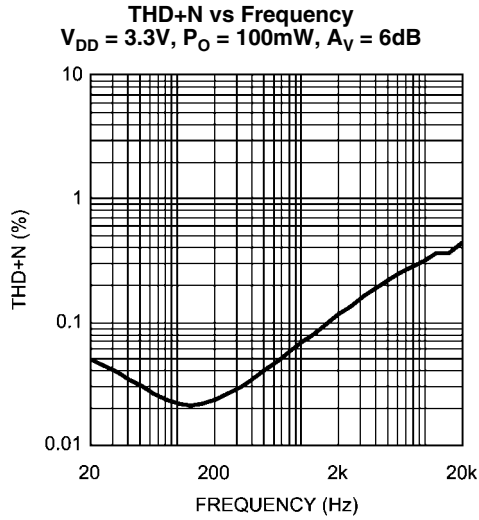

30057819

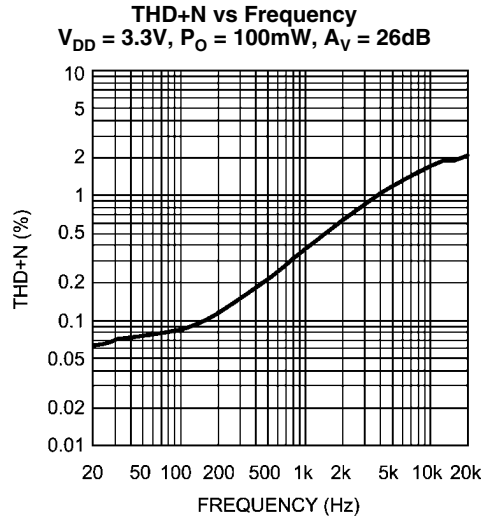

30057802

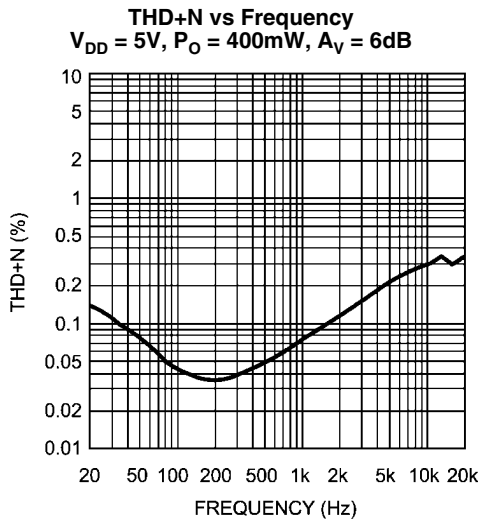

30057803

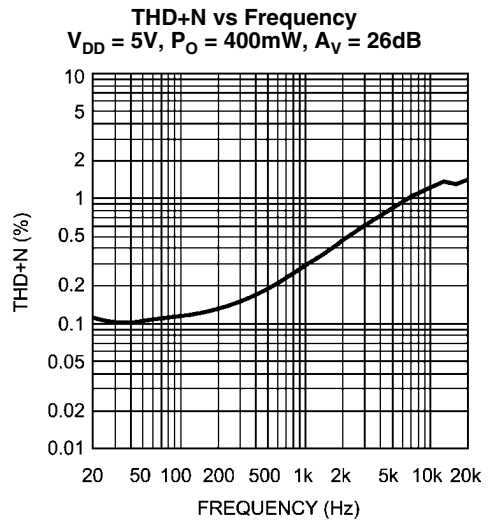

30057804

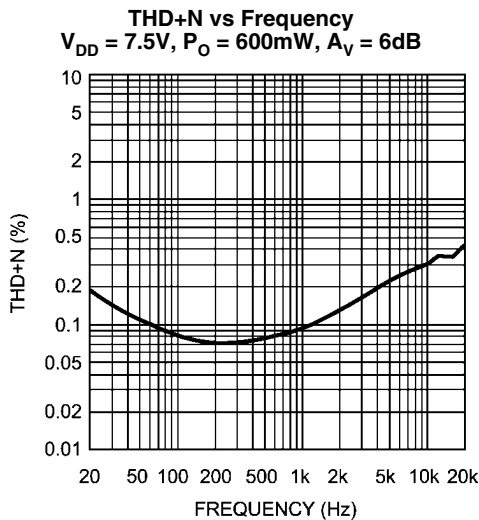

30057805

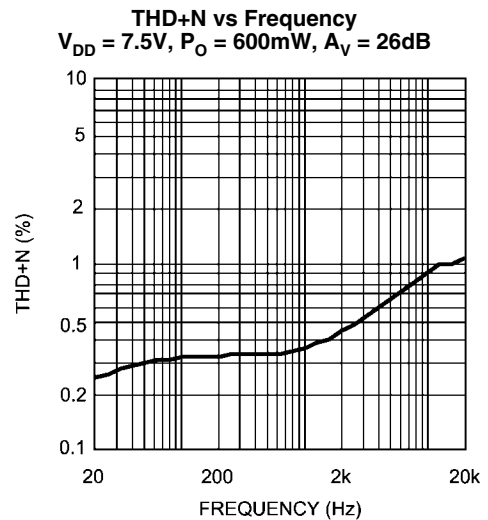

30057890

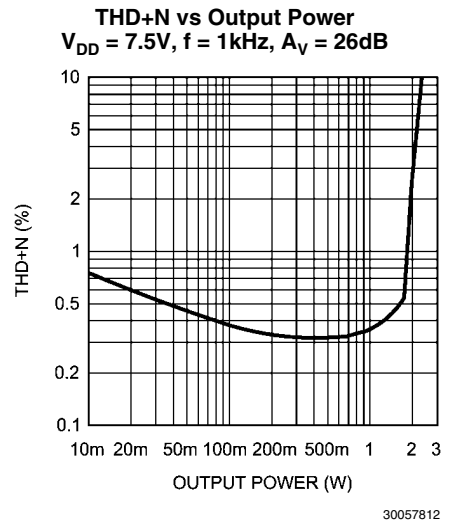
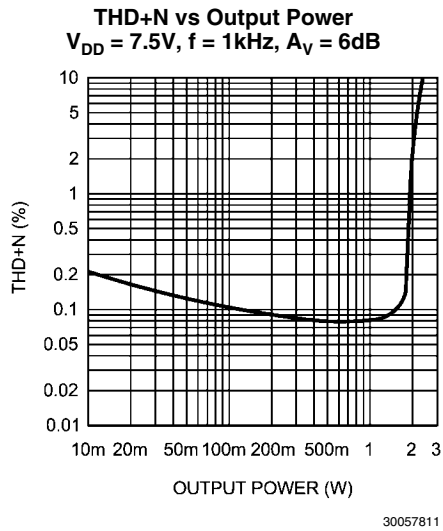
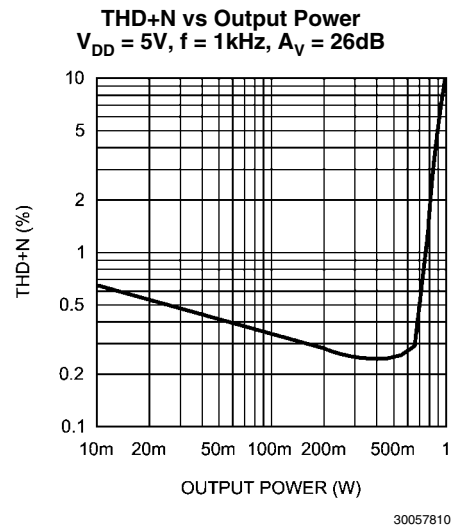
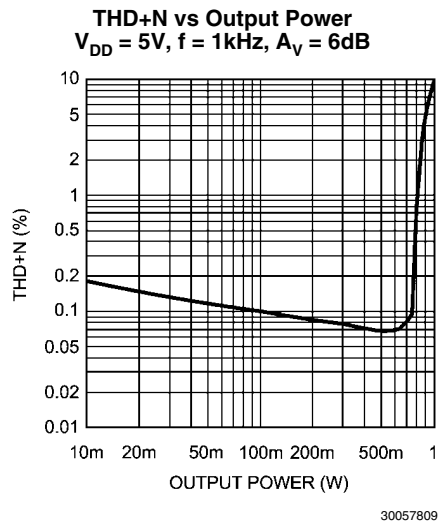
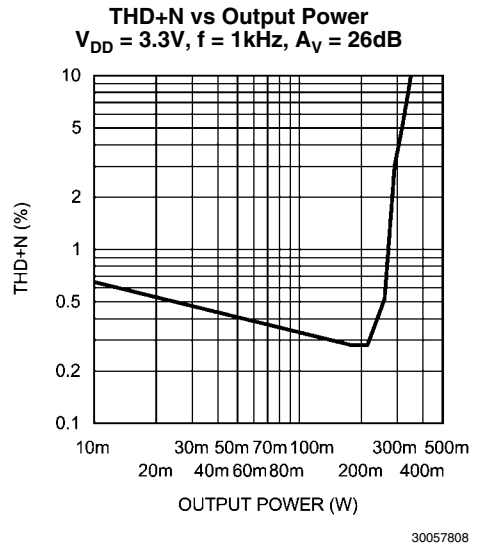
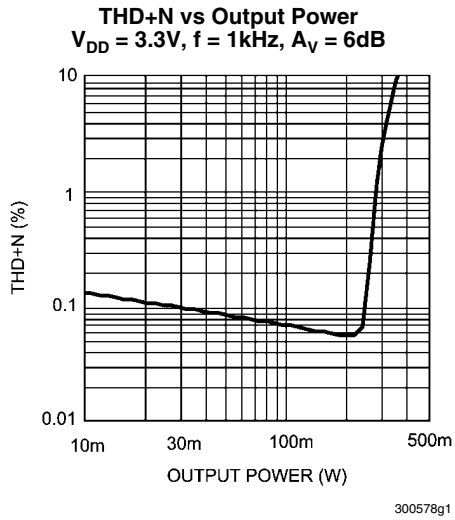

Power Supply Rejection vs Frequency
 $V_{DD} = 3.3V$, $A_V = 6dB$, $V_{RIPPLE} = 200mV_{P-P}$
 Input Terminated into 10Ω

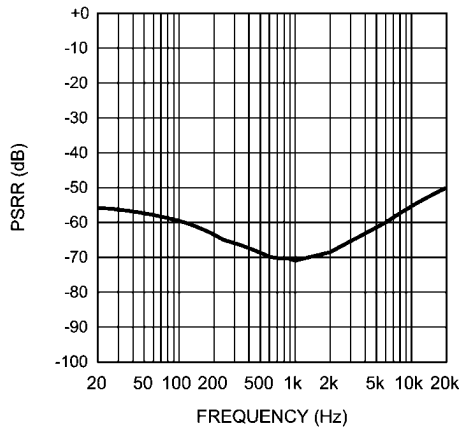

30057813

Power Supply Rejection vs Frequency
 $V_{DD} = 3.3V$, $A_V = 26dB$, $V_{RIPPLE} = 200mV_{P-P}$
 Input Terminated into 10Ω

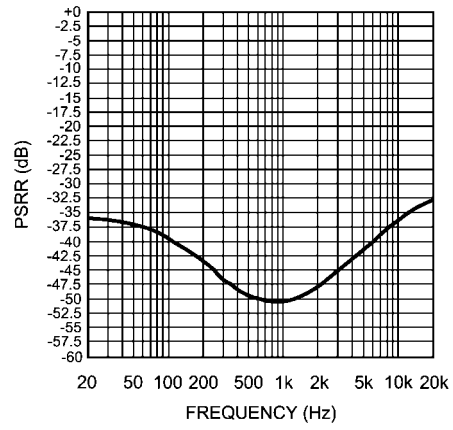

30057814

Power Supply Rejection vs Frequency
 $V_{DD} = 5V$, $A_V = 6dB$, $V_{RIPPLE} = 200mV_{P-P}$
 Input Terminated into 10Ω

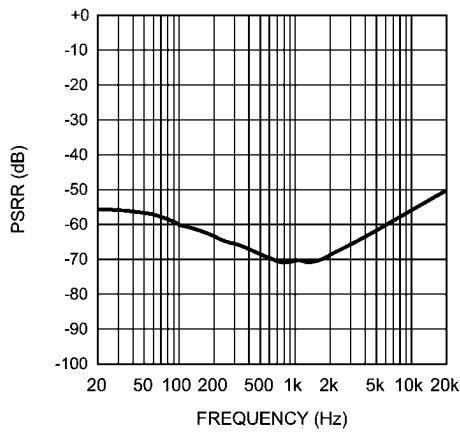

30057815

Power Supply Rejection vs Frequency
 $V_{DD} = 5V$, $A_V = 26dB$, $V_{RIPPLE} = 200mV_{P-P}$
 Input Terminated into 10Ω

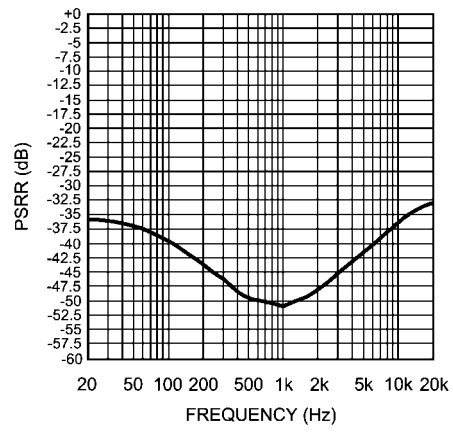

30057816

Power Supply Rejection vs Frequency
 $V_{DD} = 7.5V$, $A_V = 6dB$, $V_{RIPPLE} = 200mV_{P-P}$
 Input Terminated into 10Ω

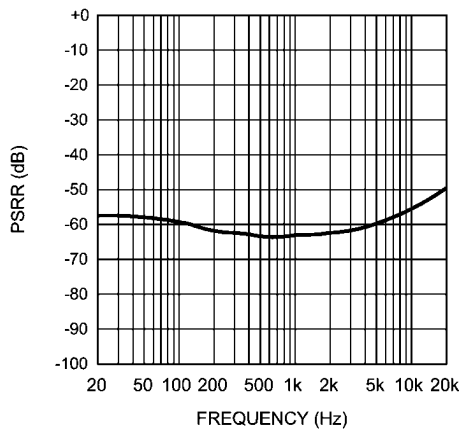

30057817

Power Supply Rejection vs Frequency
 $V_{DD} = 7.5V$, $A_V = 26dB$, $V_{RIPPLE} = 200mV_{P-P}$
 Input Terminated into 10Ω

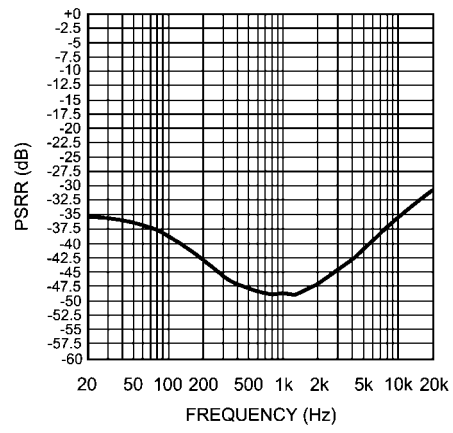

30057818

Noise Floor
 $V_{DD} = 3.3V, A_V = 6dB, R_i = R_f = 20k\Omega$
 BW < 80kHz, A-weighted

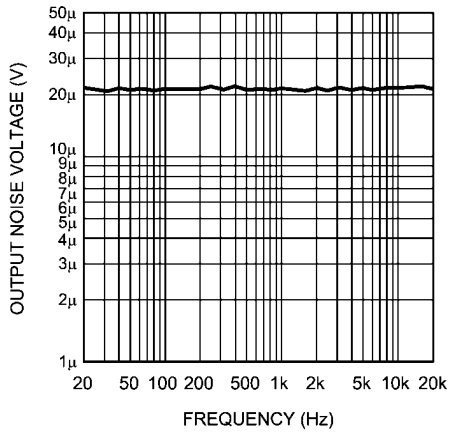

30057819

Noise Floor
 $V_{DD} = 3V, A_V = 26dB, R_i = 20k\Omega, R_f = 200k\Omega$
 BW < 80kHz, A-weighted

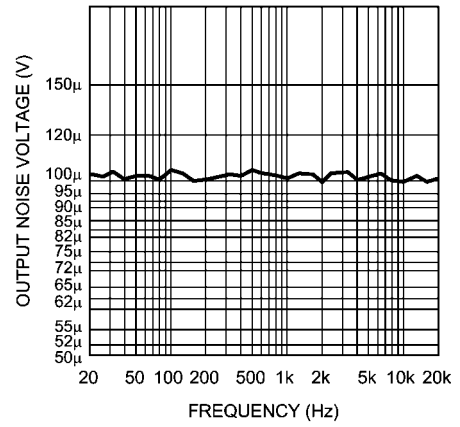

30057820

Noise Floor
 $V_{DD} = 5V, A_V = 6dB, R_i = R_f = 20k\Omega$
 BW < 80kHz, A-weighted

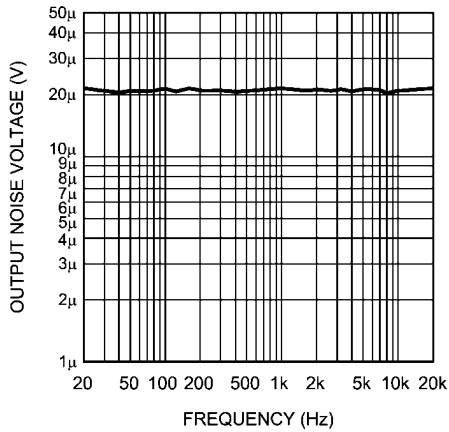

30057821

Noise Floor
 $V_{DD} = 5V, A_V = 26dB, R_i = 20k\Omega, R_f = 200k\Omega$
 BW < 80kHz, A-weighted

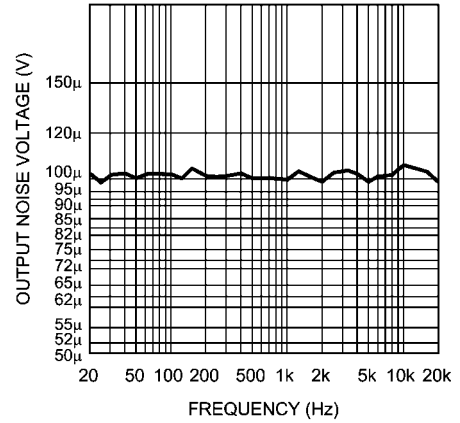

30057822

Noise Floor
 $V_{DD} = 7.5V, A_V = 6dB, R_i = R_f = 20k\Omega$
 BW < 80kHz, A-weighted

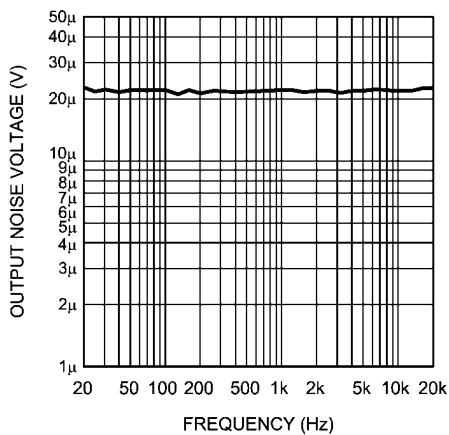

30057823

Noise Floor
 $V_{DD} = 7.5V, A_V = 26dB, R_i = 20k\Omega, R_f = 200k\Omega$
 BW < 80kHz, A-weighted

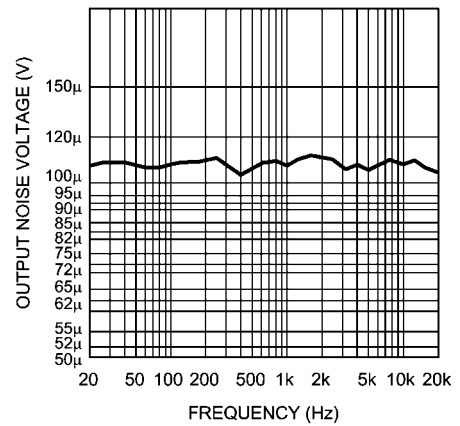

30057824

Power Dissipation vs Output Power
 $V_{DD} = 3.3V, R_L = 8\Omega, f = 1kHz$

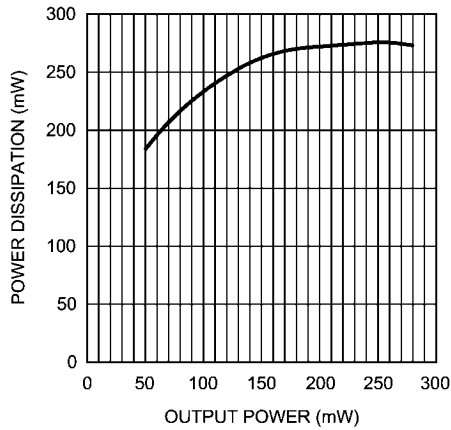

30057825

Power Dissipation vs Output Power
 $V_{DD} = 7.5V, R_L = 8\Omega, f = 1kHz$

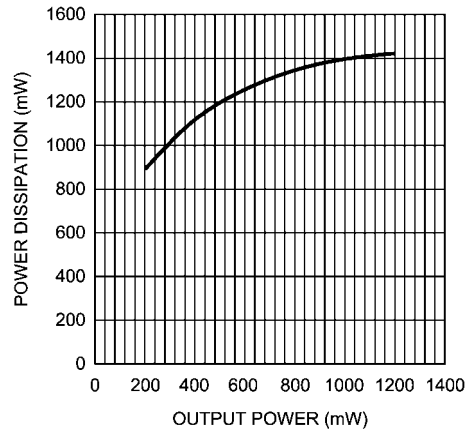

30057826

Supply Current vs Supply Voltage
 $R_L = 8\Omega, V_{IN} = 0V, R_{source} = 50\Omega$

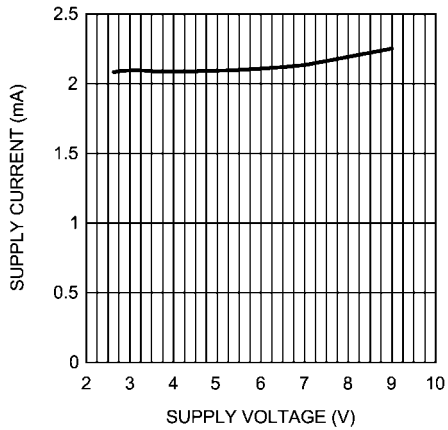

30057827

Clipping Voltage vs Supply Voltage
 $R_L = 8\Omega,$
 from top to bottom: Negative Voltage Swing; Positive Voltage Swing

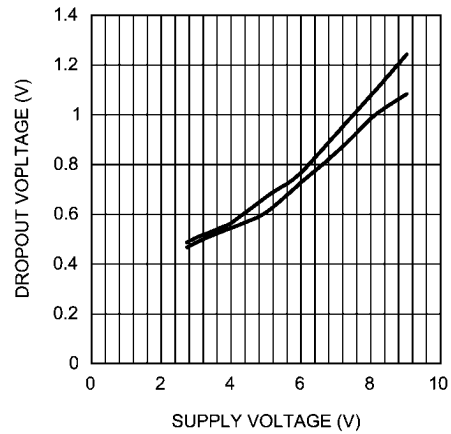

300578e9

Output Power vs Supply Voltage
 $R_L = 8\Omega,$
 from top to bottom: THD+N = 10%, THD+N = 1%

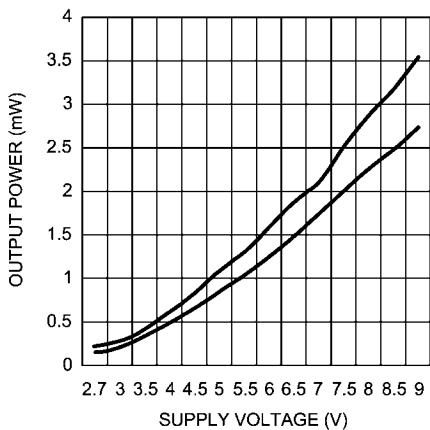

30057810

Output Power vs Load Resistance
 $V_{DD} = 3.3V, f = 1kHz$
 from top to bottom: THD+N = 10%, THD+N = 1%

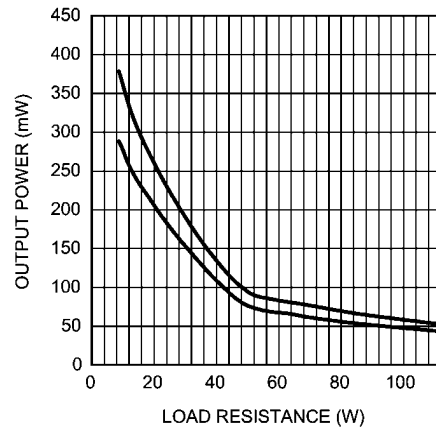

300578f1

Output Power vs Load Resistance
 $V_{DD} = 7.5V$, $f = 1kHz$
 from top to bottom: THD+N = 10%, THD+N = 1%

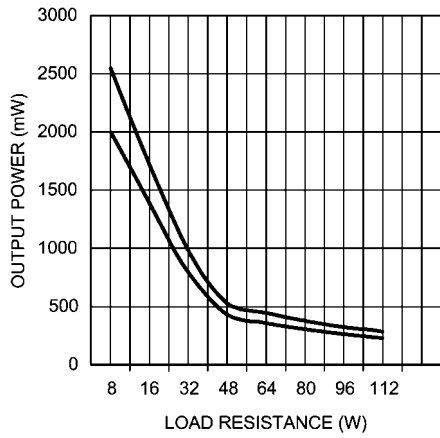

300578f2

Frequency Response vs Input Capacitor Size
 $R_L = 8\Omega$
 from top to bottom: $C_i = 1.0\mu F$, $C_i = 0.39\mu F$, $C_i = 0.039\mu F$

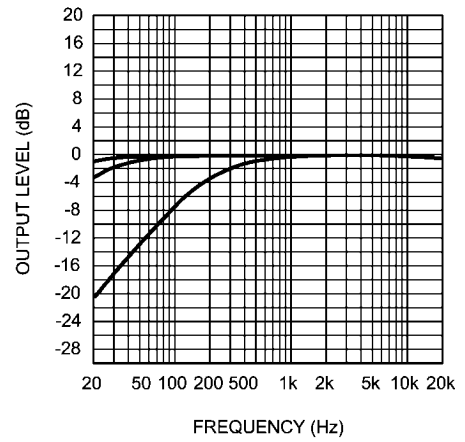

300578f3

Application Information

BRIDGE CONFIGURATION EXPLANATION

As shown in Figure 1, the LM4951A consists of two operational amplifiers that drive a speaker connected between their outputs. The value of input and feedback resistors determine the gain of each amplifier. External resistors R_i and R_f set the closed-loop gain of AMP_A , whereas two $20k\Omega$ internal resistors set AMP_B 's gain to -1. Figure 1 shows that AMP_A 's output serves as AMP_B 's input. This results in both amplifiers producing signals identical in magnitude, but 180° out of phase. Taking advantage of this phase difference, a load is placed between AMP_A and AMP_B and driven differentially (commonly referred to as "bridge-tied load"). This results in a differential, or BTL, gain of:

$$A_{VD} = 2(R_f / R_i) \quad (V/V) \quad (1)$$

Bridge mode amplifiers are different from single-ended amplifiers that drive loads connected between a single amplifier's output and ground. For a given supply voltage, bridge mode has an advantage over the single-ended configuration: its differential output doubles the voltage swing across the load. Theoretically, this produces four times the output power when compared to a single-ended amplifier under the same conditions. This increase in attainable output power assumes that the amplifier is not current limited and that the output signal is not clipped. Under rare conditions, with unique combinations of high power supply voltage and high closed loop gain settings, the LM4951A may exhibit low frequency oscillations.

Another advantage of the differential bridge output is no net DC voltage across the load. This is accomplished by biasing $AMP1$'s and $AMP2$'s outputs at half-supply. This eliminates the coupling capacitor that single supply, single-ended amplifiers require. Eliminating an output coupling capacitor in a typical single-ended configuration forces a single-supply amplifier's half-supply bias voltage across the load. This increases internal IC power dissipation and may permanently damage loads such as speakers.

POWER DISSIPATION

The LM4951A's dissipation when driving a BTL load is given by Equation (2). For a 7.5V supply and a single 8Ω BTL load, the dissipation is 1.42W.

$$P_{D_{MAX-MONOBTL}} = 4(V_{DD})^2 / 2\pi^2 R_L \quad (W) \quad (2)$$

The maximum power dissipation point given by Equation (2) must not exceed the power dissipation given by Equation (3):

$$P_{D_{MAX}} = (T_{J_{MAX}} - T_A) / \theta_{JA} \quad (3)$$

The LM4951A's $T_{J_{MAX}} = 150^\circ\text{C}$. In the SD package, the LM4951A's θ_{JA} is 73°C/W when the metal tab is soldered to a copper plane of at least 1in^2 . This plane can be split between the top and bottom layers of a two-sided PCB. Connect the two layers together under the tab with an array of vias. At any given ambient temperature T_A , use Equation (3) to find the maximum internal power dissipation supported by the IC packaging. Rearranging Equation (3) and substituting $P_{D_{MAX}}$ for $P_{D_{MAX}}$ results in Equation (4). This equation gives the maximum ambient temperature that still allows maximum

stereo power dissipation without violating the LM4951A's maximum junction temperature.

$$T_A = T_{J_{MAX}} - P_{D_{MAX-MONOBTL}} \theta_{JA} \quad (^\circ\text{C}) \quad (4)$$

For a typical application with a 7.5V power supply and a BTL 8Ω load, the maximum ambient temperature that allows maximum stereo power dissipation without exceeding the maximum junction temperature is 46°C for the SD package.

$$T_{J_{MAX}} = P_{D_{MAX-MONOBTL}} \theta_{JA} + T_A \quad (^\circ\text{C}) \quad (5)$$

Equation (5) gives the maximum junction temperature $T_{J_{MAX}}$. If the result violates the LM4951A's maximum junction temperature of 150°C , reduce the maximum junction temperature by reducing the power supply voltage or increasing the load resistance. Further allowance should be made for increased ambient temperatures.

The above examples assume that a device is operating around the maximum power dissipation point. Since internal power dissipation is a function of output power, higher ambient temperatures are allowed as output power or duty cycle decreases.

If the result of Equation (2) is greater than that of Equation (3), then decrease the supply voltage, increase the load impedance, or reduce the ambient temperature. Further, ensure that speakers rated at a nominal 8Ω do not fall below 6Ω . If these measures are insufficient, a heat sink can be added to reduce θ_{JA} . The heat sink can be created using additional copper area around the package, with connections to the ground pins, supply pin and amplifier output pins. Refer to the **Typical Performance Characteristics** curves for power dissipation information at lower output power levels.

POWER SUPPLY BYPASSING

As with any power amplifier, proper supply bypassing is critical for low noise performance and high power supply rejection. Applications that employ a voltage regulator typically use a $10\mu\text{F}$ in parallel with a $0.1\mu\text{F}$ filter capacitors to stabilize the regulator's output, reduce noise on the supply line, and improve the supply's transient response. However, their presence does not eliminate the need for a local $1.0\mu\text{F}$ tantalum bypass capacitance connected between the LM4951A's supply pins and ground. Do not substitute a ceramic capacitor for the tantalum. Doing so may cause oscillation. Keep the length of leads and traces that connect capacitors between the LM4951A's power supply pin and ground as short as possible. Connecting a larger capacitor, C_{BYPASS} , between the BYPASS pin and ground improves the internal bias voltage's stability and improves the amplifier's PSRR. The PSRR improvements increase as the bypass pin capacitor value increases. Too large, however, increases turn-on time and can compromise the amplifier's click and pop performance. The selection of bypass capacitor values, especially C_{BYPASS} , depends on desired PSRR requirements, click and pop performance, system cost, and size constraints.

MICRO-POWER SHUTDOWN

The LM4951A features an active-low micro-power shutdown mode. When active, the LM4951A's micro-power shutdown feature turns off the amplifier's bias circuitry, reducing the supply current. The low $0.01\mu\text{A}$ typical shutdown current is achieved by applying a voltage to the SHUTDOWN pin that

is as near to GND as possible. A voltage that is greater than GND may increase the shutdown current.

SELECTING EXTERNAL COMPONENTS

Input Capacitor Value Selection

Two quantities determine the value of the input coupling capacitor: the lowest audio frequency that requires amplification and desired output transient suppression.

As shown in Figure 1, the input resistor (R_i) and the input capacitor (C_i) create a high-pass filter. The cutoff frequency can be found using Equation (6).

$$f_c = 1/2\pi R_i C_i \quad (\text{Hz}) \quad (6)$$

As an example when using a speaker with a low frequency limit of 50Hz, C_i , using Equation (6) is 0.159 μ F with R_i set to 20k Ω . The values for C_i and R_i shown in Figure 1 allow the LM4951A to drive a high efficiency, full range speaker whose response extends down to 20Hz.

Selecting Value A For R_C

The LM4951A is designed for very fast turn on time. The C_{CHG} pin allows the input capacitor to charge quickly to improve click/pop performance. R_C protects the C_{CHG} pin from any over/under voltage conditions caused by excessive input signal or an active input signal when the device is in shutdown. The recommended value for R_C is 1k Ω . If the input signal is less than $V_{\text{DD}}+0.3\text{V}$ and greater than -0.3V , and if the input signal is disabled when in shutdown mode, R_C may be shorted out.

OPTIMIZING CLICK AND POP REDUCTION PERFORMANCE

The LM4951A contains circuitry that eliminates turn-on and shutdown transients ("clicks and pops"). For this discussion,

turn-on refers to either applying the power supply voltage or when the micro-power shutdown mode is deactivated.

As the $V_{\text{DD}}/2$ voltage present at the BYPASS pin ramps to its final value, the LM4951A's internal amplifiers are configured as unity gain buffers. An internal current source charges the capacitor connected between the BYPASS pin and GND in a controlled manner. Ideally, the input and outputs track the voltage applied to the BYPASS pin.

The gain of the internal amplifiers remains unity until the voltage on the bypass pin reaches $V_{\text{DD}}/2$. As soon as the voltage on the bypass pin is stable, there is a delay to prevent undesirable output transients ("click and pops"). After this delay, the device becomes fully functional.

THERMAL SHUTDOWN AND SHORT CIRCUIT PROTECTION

The LM4951A has thermal shutdown and short circuit protection to fully protect the device. The thermal shutdown circuit is activated when the die temperature exceeds a safe temperature. The short circuit protection circuitry senses the output current. When the output current exceeds the threshold under a short condition, a short will be detected and the output deactivated until the short condition is removed. If the output current is lower than the threshold then a short will not be detected and the outputs will not be deactivated. Under such conditions the die temperature will increase and, if the condition persists to raise the die temperature to the thermal shutdown threshold, initiate a thermal shutdown response. Once the die cools the outputs will become active.

RECOMMENDED PRINTED CIRCUIT BOARD LAYOUT

Figures 2–4 show the recommended two-layer PC board layout that is optimized for the SD10A. This circuit is designed for use with an external 7.5V supply 8 Ω (min) speakers.

Demonstration Board Circuit

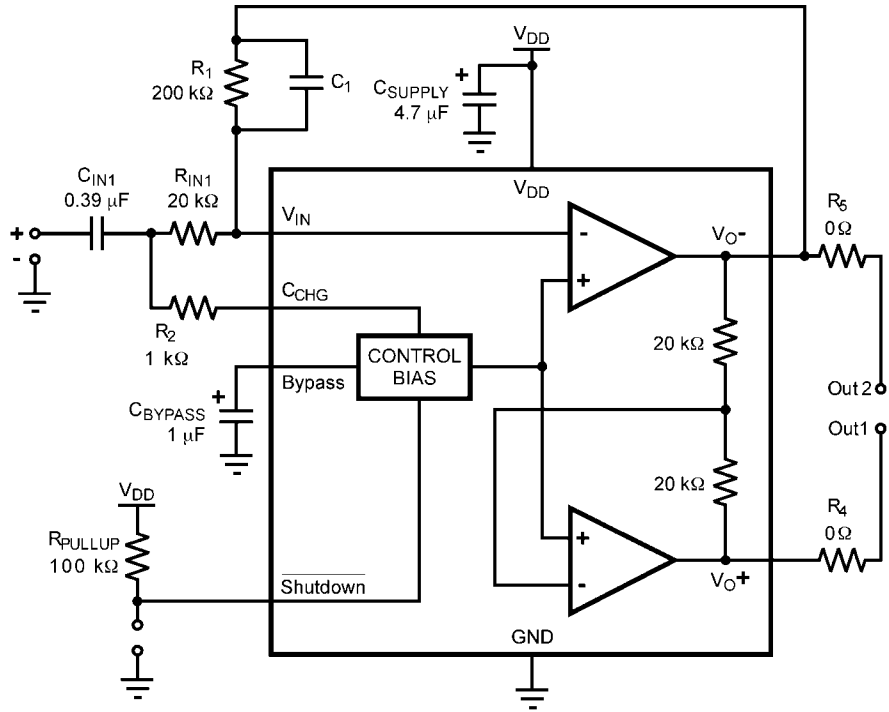

30057830

FIGURE 2. Demo Board Circuit

Demonstration Board Layout

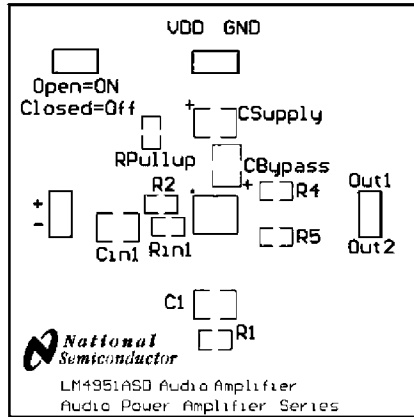

30057832

FIGURE 3. Top Silkscreen

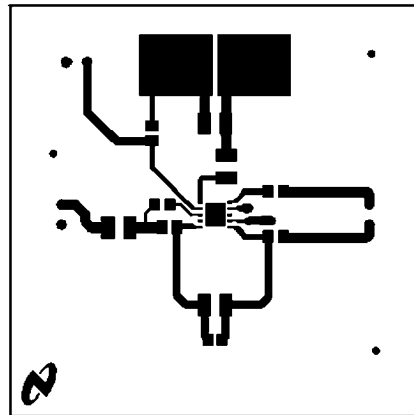

30057817

FIGURE 4. Top Layer

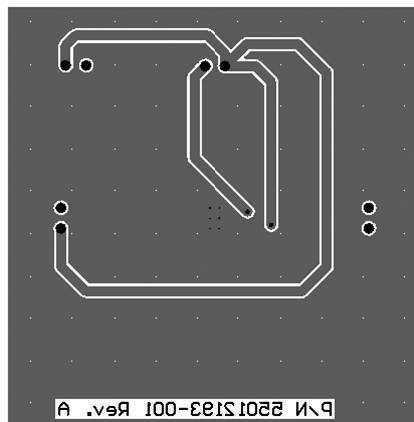

30057816

FIGURE 5. Bottom Layer

Bill Of Materials

TABLE 2. Bill Of Materials

Designator	Value	Tolerance	Part Description	Comments
R _{IN1}	20k Ω	1%	1/8W, 0805 Resistor	
R ₁	200k Ω	1%	1/8W, 0805 Resistor	
R _{PULLUP}	100k Ω	1%	1/8W, 0805 Resistor	
R ₂	1k Ω	1%	1/8W, 0805 Resistor	
R ₄ , R ₅	0 Ω	1%	1/8W, 0805 Resistor	
C _{IN1}	0.39 μ F	10%	Ceramic Capacitor, 25V, Size 1206	
C _{SUPPLY}	4.7 μ F	10%	16V Tantalum Capacitor, Size A	
C _{BYPASS}	1 μ F	10%	16V Tantalum Capacitor, Size A	
C ₁				Not Used
			0.100" 1x2 header, vertical mount	Input, Output, Vdd/GND Shutdown
U ₁			LM4951A, Mono, 1.8W, Audio Amplifier	SDC10A package

Revision History

Rev	Date	Description
1.0	08/13/08	Initial release.
1.01	09/05/08	Text edits.

Physical Dimensions inches (millimeters) unless otherwise noted

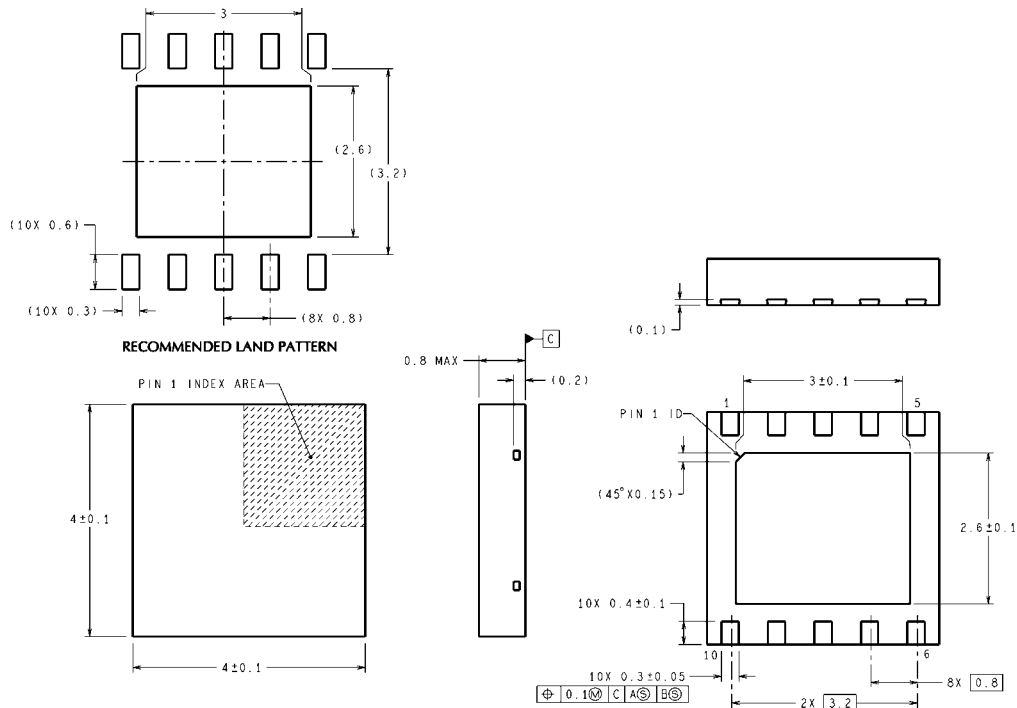

DIMENSIONS ARE IN MILLIMETERS

Order Number LM4951ASD
NS Package Number SDC10A

SDC10A (Rev A)

Notes

For more National Semiconductor product information and proven design tools, visit the following Web sites at:

Products		Design Support	
Amplifiers	www.national.com/amplifiers	WEBENCH	www.national.com/webench
Audio	www.national.com/audio	Analog University	www.national.com/AU
Clock Conditioners	www.national.com/timing	App Notes	www.national.com/appnotes
Data Converters	www.national.com/adc	Distributors	www.national.com/contacts
Displays	www.national.com/displays	Green Compliance	www.national.com/quality/green
Ethernet	www.national.com/ethernet	Packaging	www.national.com/packaging
Interface	www.national.com/interface	Quality and Reliability	www.national.com/quality
LVDS	www.national.com/lvds	Reference Designs	www.national.com/refdesigns
Power Management	www.national.com/power	Feedback	www.national.com/feedback
Switching Regulators	www.national.com/switchers		
LDOs	www.national.com/ldo		
LED Lighting	www.national.com/led		
PowerWise	www.national.com/powerwise		
Serial Digital Interface (SDI)	www.national.com/sdi		
Temperature Sensors	www.national.com/tempsensors		
Wireless (PLL/VCO)	www.national.com/wireless		

THE CONTENTS OF THIS DOCUMENT ARE PROVIDED IN CONNECTION WITH NATIONAL SEMICONDUCTOR CORPORATION ("NATIONAL") PRODUCTS. NATIONAL MAKES NO REPRESENTATIONS OR WARRANTIES WITH RESPECT TO THE ACCURACY OR COMPLETENESS OF THE CONTENTS OF THIS PUBLICATION AND RESERVES THE RIGHT TO MAKE CHANGES TO SPECIFICATIONS AND PRODUCT DESCRIPTIONS AT ANY TIME WITHOUT NOTICE. NO LICENSE, WHETHER EXPRESS, IMPLIED, ARISING BY ESTOPPEL OR OTHERWISE, TO ANY INTELLECTUAL PROPERTY RIGHTS IS GRANTED BY THIS DOCUMENT.

TESTING AND OTHER QUALITY CONTROLS ARE USED TO THE EXTENT NATIONAL DEEMS NECESSARY TO SUPPORT NATIONAL'S PRODUCT WARRANTY. EXCEPT WHERE MANDATED BY GOVERNMENT REQUIREMENTS, TESTING OF ALL PARAMETERS OF EACH PRODUCT IS NOT NECESSARILY PERFORMED. NATIONAL ASSUMES NO LIABILITY FOR APPLICATIONS ASSISTANCE OR BUYER PRODUCT DESIGN. BUYERS ARE RESPONSIBLE FOR THEIR PRODUCTS AND APPLICATIONS USING NATIONAL COMPONENTS. PRIOR TO USING OR DISTRIBUTING ANY PRODUCTS THAT INCLUDE NATIONAL COMPONENTS, BUYERS SHOULD PROVIDE ADEQUATE DESIGN, TESTING AND OPERATING SAFEGUARDS.

EXCEPT AS PROVIDED IN NATIONAL'S TERMS AND CONDITIONS OF SALE FOR SUCH PRODUCTS, NATIONAL ASSUMES NO LIABILITY WHATSOEVER, AND NATIONAL DISCLAIMS ANY EXPRESS OR IMPLIED WARRANTY RELATING TO THE SALE AND/OR USE OF NATIONAL PRODUCTS INCLUDING LIABILITY OR WARRANTIES RELATING TO FITNESS FOR A PARTICULAR PURPOSE, MERCHANTABILITY, OR INFRINGEMENT OF ANY PATENT, COPYRIGHT OR OTHER INTELLECTUAL PROPERTY RIGHT.

LIFE SUPPORT POLICY

NATIONAL'S PRODUCTS ARE NOT AUTHORIZED FOR USE AS CRITICAL COMPONENTS IN LIFE SUPPORT DEVICES OR SYSTEMS WITHOUT THE EXPRESS PRIOR WRITTEN APPROVAL OF THE CHIEF EXECUTIVE OFFICER AND GENERAL COUNSEL OF NATIONAL SEMICONDUCTOR CORPORATION. As used herein:

Life support devices or systems are devices which (a) are intended for surgical implant into the body, or (b) support or sustain life and whose failure to perform when properly used in accordance with instructions for use provided in the labeling can be reasonably expected to result in a significant injury to the user. A critical component is any component in a life support device or system whose failure to perform can be reasonably expected to cause the failure of the life support device or system or to affect its safety or effectiveness.

National Semiconductor and the National Semiconductor logo are registered trademarks of National Semiconductor Corporation. All other brand or product names may be trademarks or registered trademarks of their respective holders.

Copyright© 2008 National Semiconductor Corporation

For the most current product information visit us at www.national.com



National Semiconductor Americas Technical Support Center
Email: support@nsc.com
Tel: 1-800-272-9959

National Semiconductor Europe Technical Support Center
Email: europe.support@nsc.com
German Tel: +49 (0) 180 5010 771
English Tel: +44 (0) 870 850 4288

National Semiconductor Asia Pacific Technical Support Center
Email: ap.support@nsc.com

National Semiconductor Japan Technical Support Center
Email: jpn.feedback@nsc.com