

## LM4951 Boomer® Audio Power Amplifier Series

### Wide Voltage Range 1.8 Watt Audio Amplifier

#### General Description

The LM4951 is an audio power amplifier primarily designed for demanding applications in Portable Handheld devices. It is capable of delivering 1.8W mono BTL to an 8Ω load, continuous average power, with less than 1% distortion (THD+N) from a 7.5V<sub>DC</sub> power supply.

Boomer audio power amplifiers were designed specifically to provide high quality output power with a minimal amount of external components. The LM4951 does not require bootstrap capacitors, or snubber circuits.

The LM4951 features a low-power consumption active-low shutdown mode. Additionally, the LM4951 features an internal thermal shutdown protection mechanism.

The LM4951 contains advanced pop & click circuitry that eliminates noises which would otherwise occur during turn-on and turn-off transitions.

The LM4951 is unity-gain stable and can be configured by external gain-setting resistors.

#### Key Specifications

■ Wide Voltage Range	2.7V to 9V
■ Quiescent Power Supply Current (V <sub>DD</sub> = 7.5V)	2.5mA (typ)
■ Power Output BTL at 7.5V, 1% THD	1.8W (typ)
■ Shutdown Current	0.01μA (typ)
■ Fast Turn on Time	25mS (typ)

#### Features

- Pop & click circuitry eliminates noise during turn-on and turn-off transitions
- Low current, active-low shutdown mode
- Low quiescent current
- Thermal shutdown protection
- Unity-gain stable
- External gain configuration capability

#### Applications

- Portable Handheld Devices up to 9V
- Cell Phone
- PDA

#### Typical Application

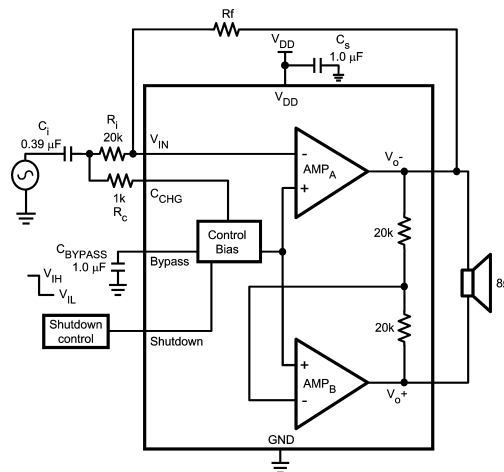

200942F4

\* R<sub>C</sub> is needed for over/under voltage protection. If inputs are less than V<sub>DD</sub> +0.3V and greater than -0.3V, and if inputs are disabled when in shutdown mode, then R<sub>C</sub> may be shorted.

**FIGURE 1. Typical Bridge-Tied-Load (BTL) Audio Amplifier Application Circuit**

# Connection Diagrams

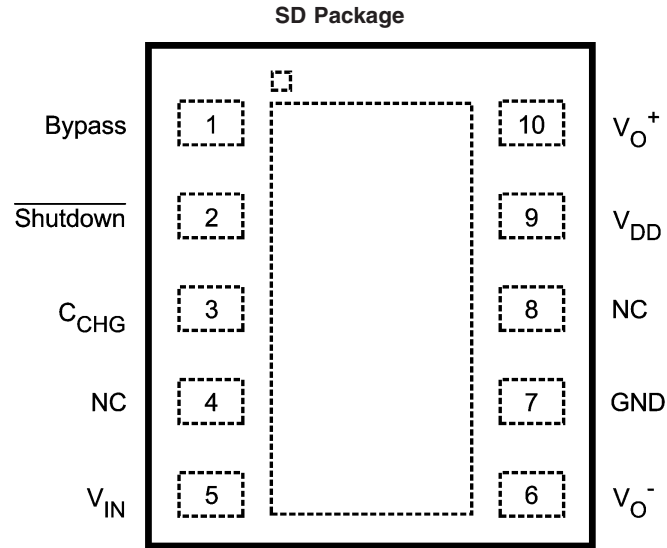

20094229

**Top View**  
**Order Number LM4951SD**  
**See NS Package Number SDC10A**

**9 Bump micro SMD Package**

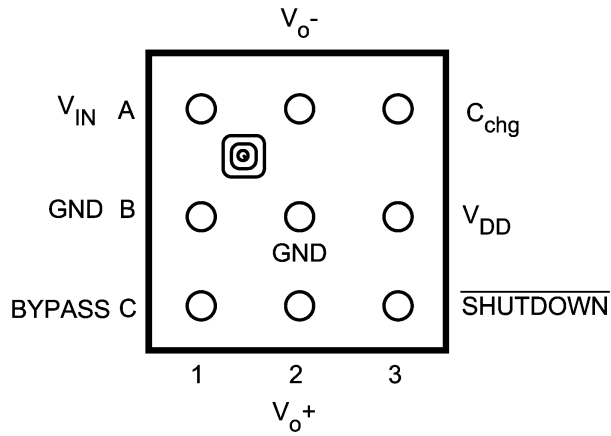

20094228

**Top View**  
**Order Number LM4951TL, TLX**  
**See NS Package Number TLA09ZZA**

\* DAP can either be soldered to GND or left floating.

**Absolute Maximum Ratings** (Notes 1, 2)

If Military/Aerospace specified devices are required, please contact the National Semiconductor Sales Office/Distributors for availability and specifications.

Supply Voltage	9.5V
Storage Temperature	-65°C to +150°C
Input Voltage	-0.3V to $V_{DD} + 0.3V$
Power Dissipation (Note 3)	Internally limited
ESD Susceptibility (Note 4)	2000V
ESD Susceptibility (Note 5)	200V
Junction Temperature	150°C

Thermal Resistance

 $\theta_{JA}$  (LLP) (Note 3)www.DataSheet4U.com  
73°C/W

See AN-1187 'Leadless

Leadframe Packaging (LLP).'

**Operating Ratings**

Temperature Range

 $T_{MIN} \leq T_A \leq T_{MAX}$  $-40^\circ\text{C} \leq T_A \leq +85^\circ\text{C}$ 

Supply Voltage

 $2.7V \leq V_{DD} \leq 9V$ **Electrical Characteristics  $V_{DD} = 7.5V$**  (Notes 1, 2)

The following specifications apply for  $V_{DD} = 7.5V$ ,  $A_{V-BTL} = 6dB$ ,  $R_L = 8\Omega$  unless otherwise specified. Limits apply for  $T_A = 25^\circ\text{C}$ .

Symbol	Parameter	Conditions	LM4951		Units (Limits)
			Typical (Note 6)	Limit (Notes 7, 8)	
$I_{DD}$	Quiescent Power Supply Current	$V_{IN} = 0V, I_O = 0A, R_L = 8\Omega$	2.5	4.5	mA (max)
$I_{SD}$	Shutdown Current	$V_{SHUTDOWN} = GND$ (Note 9)	0.01	5	$\mu\text{A}$ (max)
$V_{OS}$	Offset Voltage		5	30	mV (max)
$V_{SDIH}$	Shutdown Voltage Input High			1.2	V (min)
$V_{SDIL}$	Shutdown Voltage Input Low			0.4	V (max)
$R_{pull\downarrow}$	Pulldown Resistor on S/D		75	45	k $\Omega$ (min)
$T_{WU}$	Wake-up Time	$C_B = 1.0\mu\text{F}$	25		ms
$T_{sd}$	Shutdown time	$C_B = 1.0\mu\text{F}$		10	ms (max)
TSD	Thermal Shutdown Temperature		170	150 190	$^\circ\text{C}$ (min) $^\circ\text{C}$ (max)
$P_O$	Output Power	THD = 1% (max); $f = 1\text{kHz}$ $R_L = 8\Omega$ Mono BTL	1.8	1.5	W (min)
THD+N	Total Harmonic Distortion + Noise	$P_O = 600\text{mWrms}$ ; $f = 1\text{kHz}$ $A_{V-BTL} = 6\text{dB}$	0.07	0.5	% (max)
THD+N	Total Harmonic Distortion + Noise	$P_O = 600\text{mWrms}$ ; $f = 1\text{kHz}$ $A_{V-BTL} = 26\text{dB}$	0.35		%
$\epsilon_{OS}$	Output Noise	A-Weighted Filter, $R_i = R_f = 20\text{k}\Omega$ Input Referred, Note 10	10		$\mu\text{V}$
PSRR	Power Supply Rejection Ratio	$V_{RIPPLE} = 200\text{mV}_{p-p}$ ; $f = 217\text{Hz}$ , $C_B = 1.0\mu\text{F}$ , Input Referred	66	56	dB (min)

**Electrical Characteristics  $V_{DD} = 3.3V$**  (Notes 1, 2)

The following specifications apply for  $V_{DD} = 3.3V$ ,  $A_{V-BTL} = 6dB$ ,  $R_L = 8\Omega$  unless otherwise specified. Limits apply for  $T_A = 25^\circ\text{C}$ .

Symbol	Parameter	Conditions	LM4951		Units (Limits)
			Typical (Note 6)	Limit (Notes 7, 8)	
$I_{DD}$	Quiescent Power Supply Current	$V_{IN} = 0V, I_O = 0A, R_L = 8\Omega$	2.5	4.5	mA (max)
$I_{SD}$	Shutdown Current	$V_{SHUTDOWN} = GND$ (Note 9)	0.01	2	$\mu\text{A}$ (max)
$V_{OS}$	Offset Voltage		3	30	mV (max)
$V_{SDIH}$	Shutdown Voltage Input High			1.2	V (min)
$V_{SDIL}$	Shutdown Voltage Input Low			0.4	V (max)
$T_{WU}$	Wake-up Time	$C_B = 1.0\mu\text{F}$	25		ms (max)
$T_{sd}$	Shutdown time	$C_B = 1.0\mu\text{F}$		10	ms (max)

## Electrical Characteristics $V_{DD} = 3.3V$ (Notes 1, 2) (Continued)

The following specifications apply for  $V_{DD} = 3.3V$ ,  $A_{V-BTL} = 6dB$ ,  $R_L = 8\Omega$  unless otherwise specified. Limits apply for  $T_A = 25^\circ C$ .

Symbol	Parameter	Conditions	LM4951		Units (Limits)
			Typical (Note 6)	Limit (Notes 7, 8)	
$P_O$	Output Power	THD = 1% (max); $f = 1kHz$ $R_L = 8\Omega$ Mono BTL	280	230	W (min)
THD+N	Total Harmonic Distortion + Noise <sup>1</sup>	$P_O = 100mWrms$ ; $f = 1kHz$ $A_{V-BTL} = 6dB$	0.07	0.5	% (max)
THD+N	Total Harmonic Distortion + Noise <sup>1</sup>	$P_O = 100mWrms$ ; $f = 1kHz$ $A_{V-BTL} = 26dB$	0.35		%
$\epsilon_{OS}$	Output Noise	A-Weighted Filter, $R_i = R_f = 20k\Omega$ Input Referred, Note 10	10		$\mu V$
PSRR	Power Supply Rejection Ratio	$V_{RIPPLE} = 200mV_{p-p}$ , $f = 217Hz$ , $C_B = 1\mu F$ , Input Referred	71	61	dB (min)

**Note 1:** All voltages are measured with respect to the GND pin, unless otherwise specified.

**Note 2:** *Absolute Maximum Ratings* indicate limits beyond which damage to the device may occur. *Operating Ratings* indicate conditions for which the device is functional, but do not guarantee specific performance limits. *Electrical Characteristics* state DC and AC electrical specifications under particular test conditions which guarantee specific performance limits. This assumes that the device is within the Operating Ratings. Specifications are not guaranteed for parameters where no limit is given, however, the typical value is a good indication of device performance.

**Note 3:** The maximum power dissipation must be derated at elevated temperatures and is dictated by  $T_{JMAX}$ ,  $\theta_{JA}$ , and the ambient temperature,  $T_A$ . The maximum allowable power dissipation is  $P_{DMAX} = (T_{JMAX} - T_A) / \theta_{JA}$  or the given in Absolute Maximum Ratings, whichever is lower. For the LM4951 typical application (shown in Figure 1) with  $V_{DD} = 7.5V$ ,  $R_L = 8\Omega$  mono-BTL operation the max power dissipation is 1.42W.  $\theta_{JA} = 73^\circ C/W$ .

**Note 4:** Human body model, 100pF discharged through a 1.5k $\Omega$  resistor.

**Note 5:** Machine Model, 220pF–240pF discharged through all pins.

**Note 6:** Typicals are measured at 25 $^\circ C$  and represent the parametric norm.

**Note 7:** Limits are guaranteed to National's AOQL (Average Outgoing Quality Level).

**Note 8:** Datasheet min/max specification limits are guaranteed by design, test, or statistical analysis.

**Note 9:** Shutdown current is measured in a normal room environment. The Shutdown pin should be driven as close as possible to GND for minimum shutdown current.

**Note 10:** Noise measurements are dependent on the absolute values of the closed loop gain setting resistors (input and feedback resistors).

# Typical Performance Characteristics

www.DataSheet4U.com

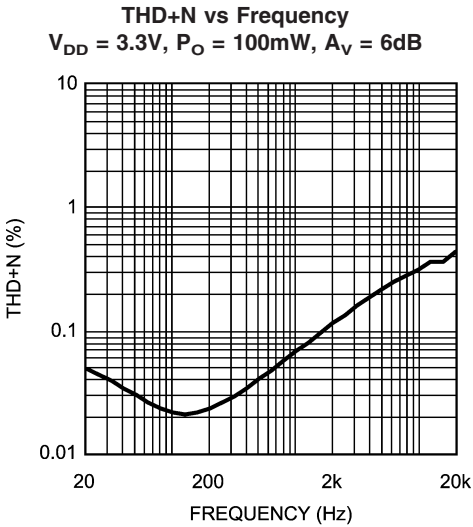

200942F9

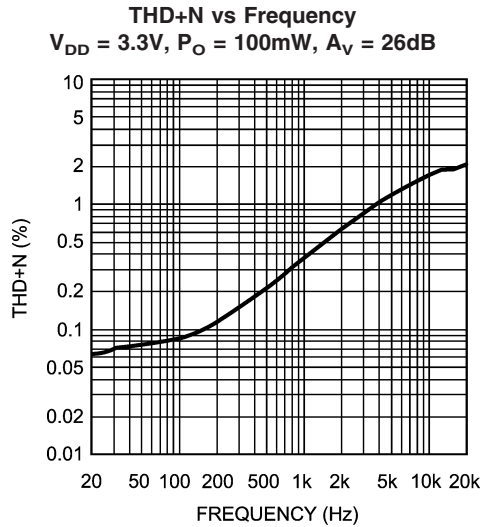

20094202

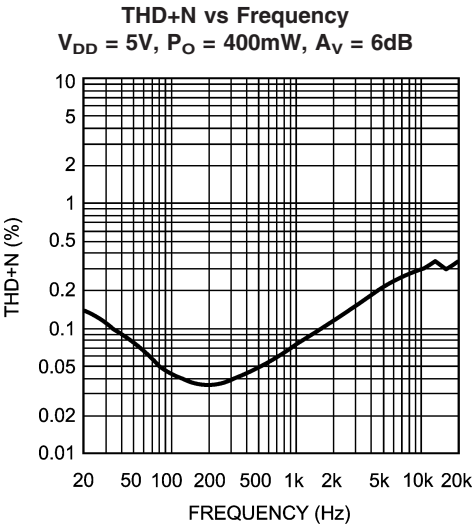

20094203

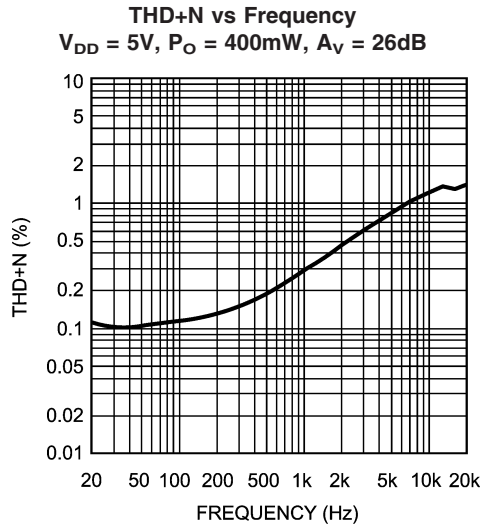

20094204

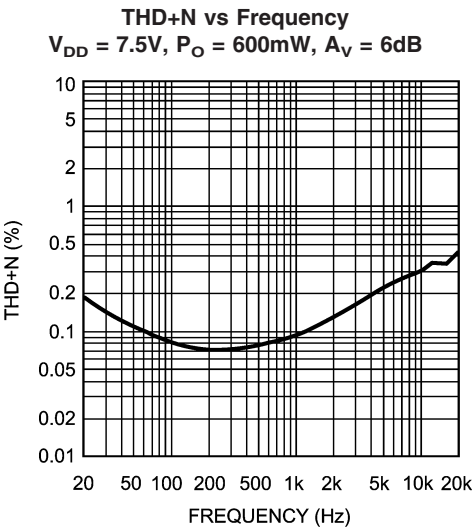

20094205

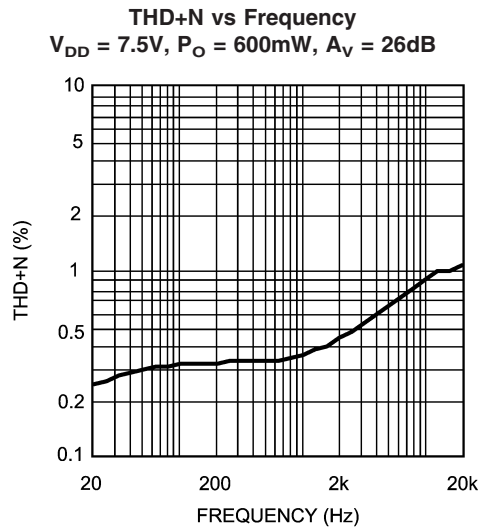

200942G0

Typical Performance Characteristics (Continued)

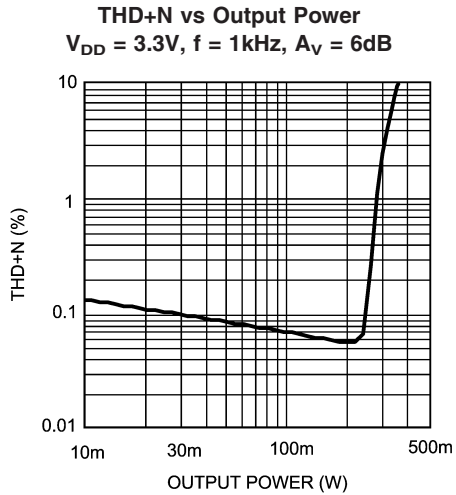

200942G1

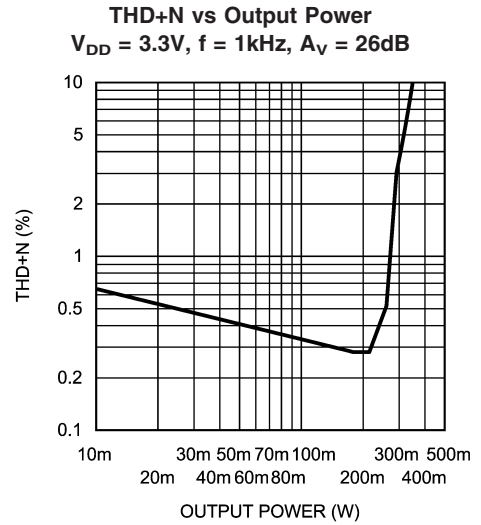

20094208

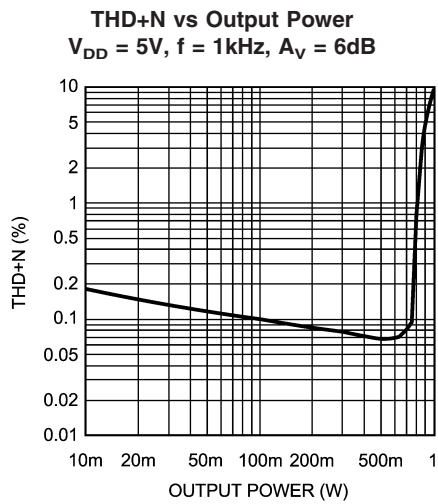

20094209

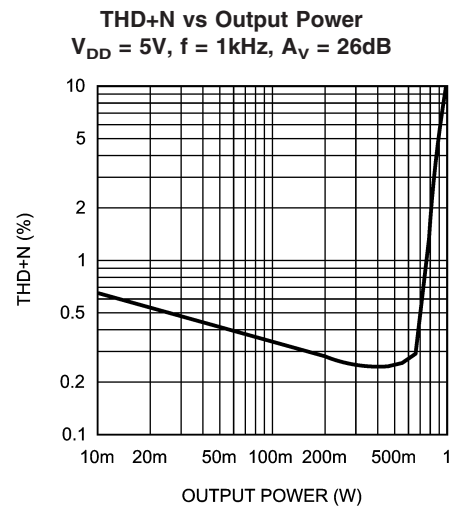

20094210

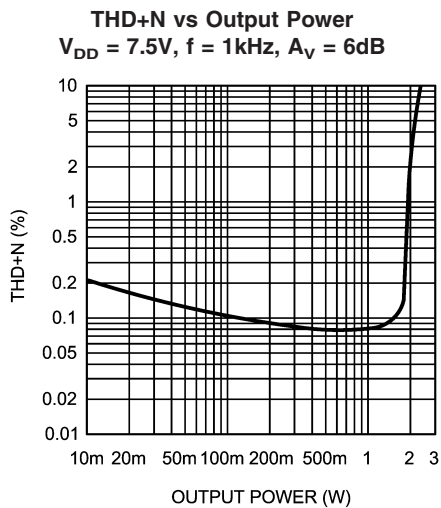

20094211

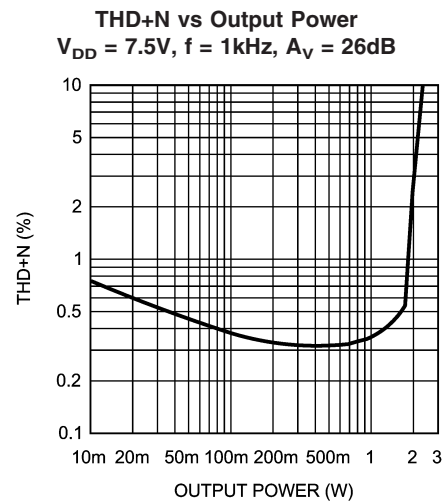

20094212

# Typical Performance Characteristics (Continued)

**Power Supply Rejection vs Frequency**  
 $V_{DD} = 3.3V$ ,  $A_V = 6dB$ ,  $V_{RIPPLE} = 200mV_{P-P}$   
 Input Terminated into  $10\Omega$

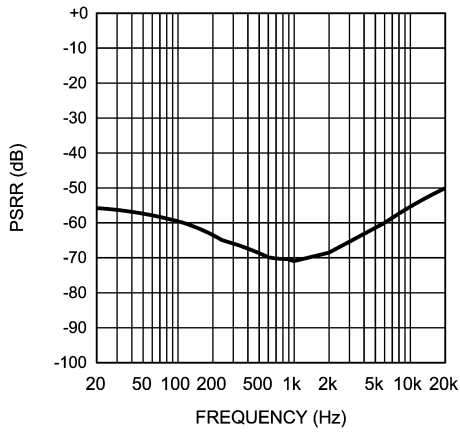

20094213

**Power Supply Rejection vs Frequency**  
 $V_{DD} = 3.3V$ ,  $A_V = 26dB$ ,  $V_{RIPPLE} = 200mV_{P-P}$   
 Input Terminated into  $10\Omega$

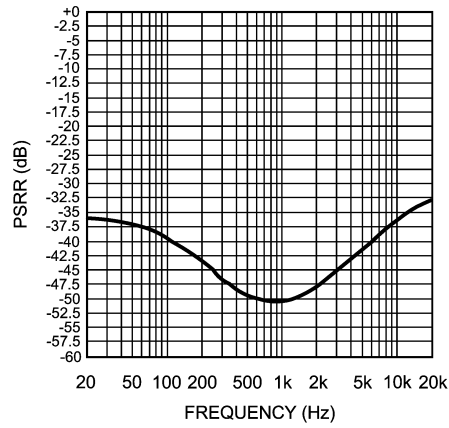

20094214

**Power Supply Rejection vs Frequency**  
 $V_{DD} = 5V$ ,  $A_V = 6dB$ ,  $V_{RIPPLE} = 200mV_{P-P}$   
 Input Terminated into  $10\Omega$

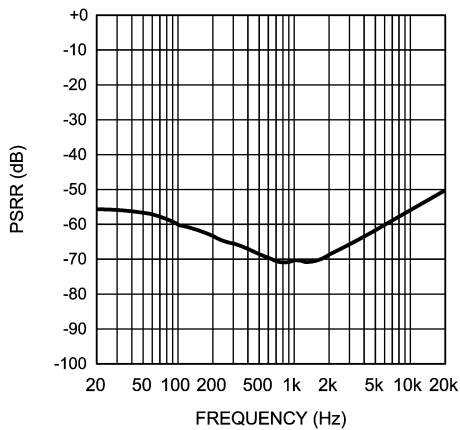

20094215

**Power Supply Rejection vs Frequency**  
 $V_{DD} = 5V$ ,  $A_V = 26dB$ ,  $V_{RIPPLE} = 200mV_{P-P}$   
 Input Terminated into  $10\Omega$

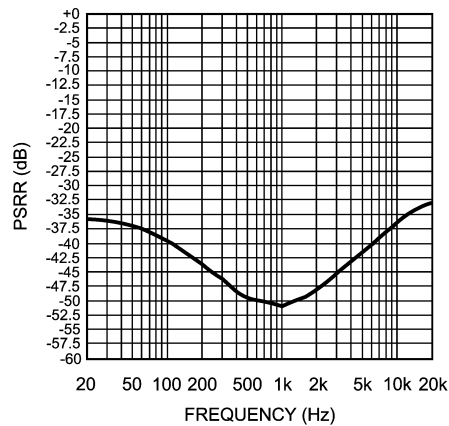

20094216

**Power Supply Rejection vs Frequency**  
 $V_{DD} = 7.5V$ ,  $A_V = 6dB$ ,  $V_{RIPPLE} = 200mV_{P-P}$   
 Input Terminated into  $10\Omega$

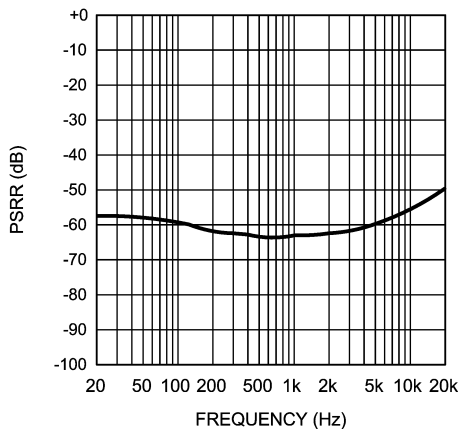

20094217

**Power Supply Rejection vs Frequency**  
 $V_{DD} = 7.5V$ ,  $A_V = 26dB$ ,  $V_{RIPPLE} = 200mV_{P-P}$   
 Input Terminated into  $10\Omega$

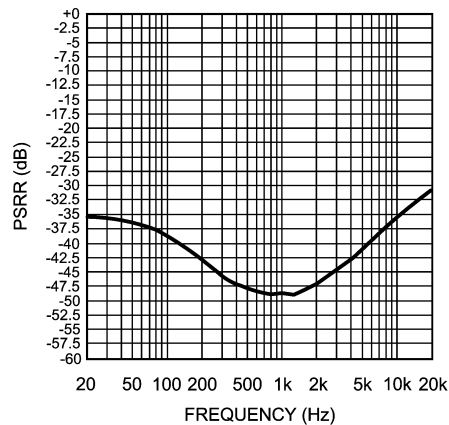

20094218

Typical Performance Characteristics (Continued)

**Noise Floor**  
 $V_{DD} = 3.3V, A_V = 6dB, R_i = R_f = 20k\Omega$   
 BW < 80kHz, A-weighted

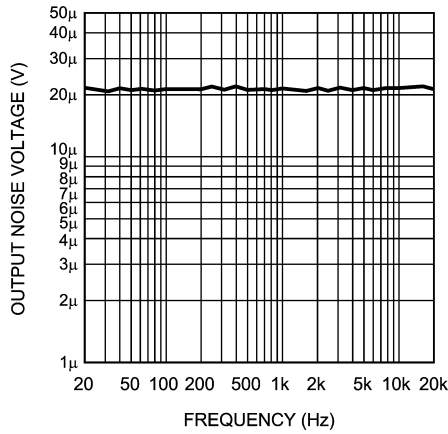

20094219

**Noise Floor**  
 $V_{DD} = 3V, A_V = 26dB, R_i = 20k\Omega, R_f = 200k\Omega$   
 BW < 80kHz, A-weighted

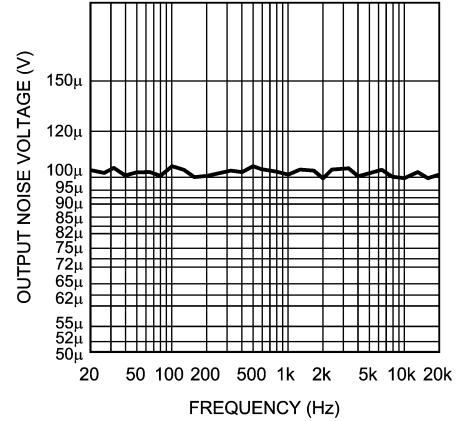

20094220

**Noise Floor**  
 $V_{DD} = 5V, A_V = 6dB, R_i = R_f = 20k\Omega$   
 BW < 80kHz, A-weighted

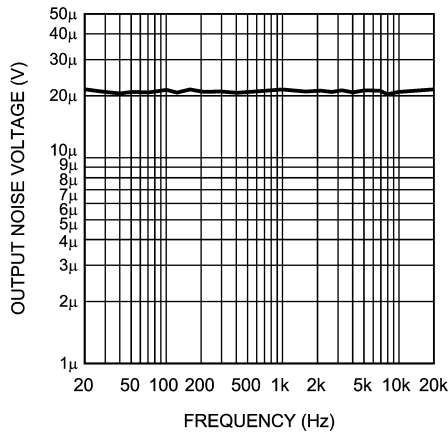

20094221

**Noise Floor**  
 $V_{DD} = 5V, A_V = 26dB, R_i = 20k\Omega, R_f = 200k\Omega$   
 BW < 80kHz, A-weighted

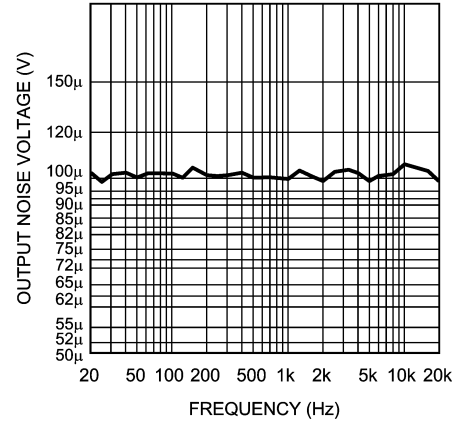

20094222

**Noise Floor**  
 $V_{DD} = 7.5V, A_V = 6dB, R_i = R_f = 20k\Omega$   
 BW < 80kHz, A-weighted

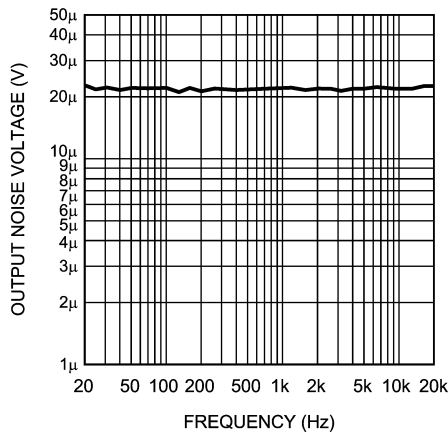

20094223

**Noise Floor**  
 $V_{DD} = 7.5V, A_V = 26dB, R_i = 20k\Omega, R_f = 200k\Omega$   
 BW < 80kHz, A-weighted

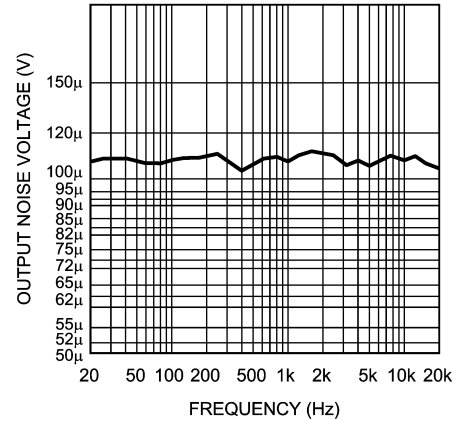

20094224



Typical Performance Characteristics (Continued)

www.DataSheet4U.com

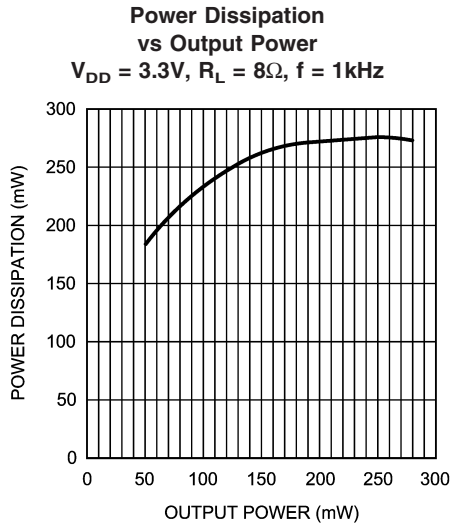

20094225

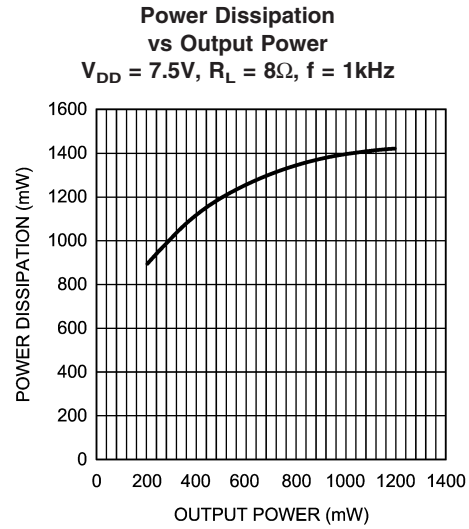

20094226

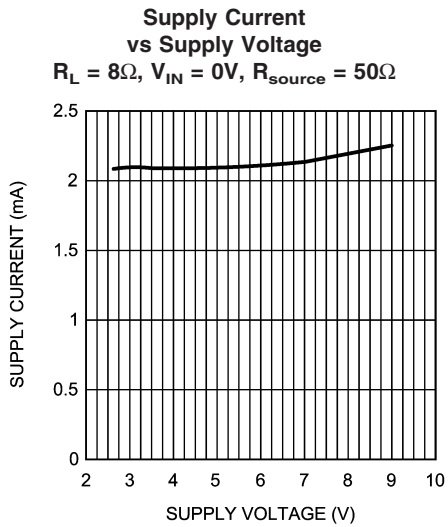

20094227

**Clipping Voltage vs Supply Voltage**  
 $R_L = 8\Omega,$   
 from top to bottom: Negative Voltage Swing; Positive Voltage Swing

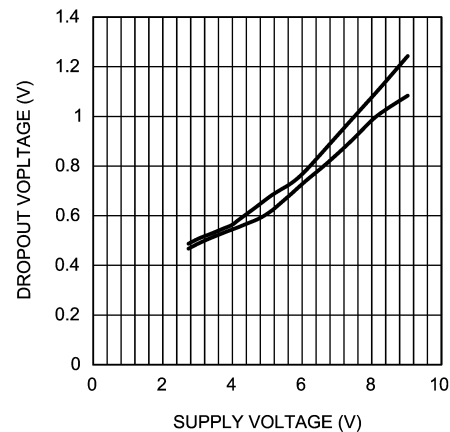

200942E9

**Output Power vs Supply Voltage**  
 $R_L = 8\Omega,$   
 from top to bottom: THD+N = 10%, THD+N = 1%

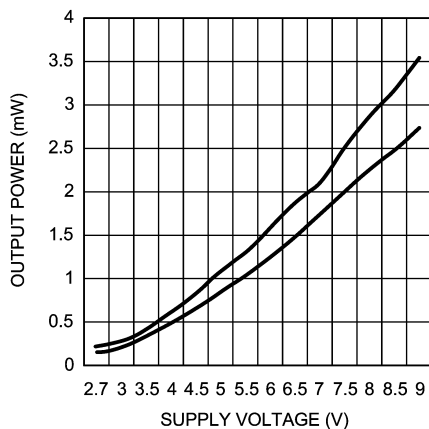

200942F0

**Output Power vs Load Resistance**  
 $V_{DD} = 3.3V, f = 1kHz$   
 from top to bottom: THD+N = 10%, THD+N = 1%

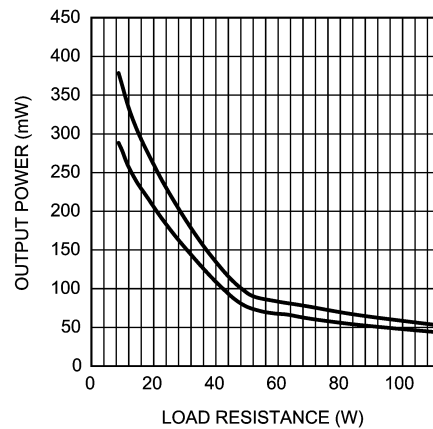

200942F1

# Typical Performance Characteristics (Continued)

www.DataSheet4U.com

**Output Power vs Load Resistance**  
 $V_{DD} = 7.5V, f = 1kHz$   
 from top to bottom: THD+N = 10%, THD+N = 1%

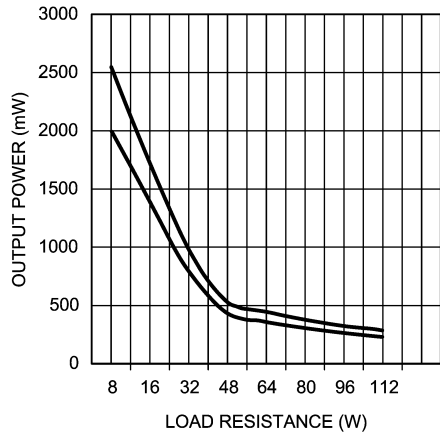

200942F2

**Frequency Response vs Input Capacitor Size**  
 $R_L = 8\Omega$   
 from top to bottom:  $C_i = 1.0\mu F, C_i = 0.39\mu F, C_i = 0.039\mu F$

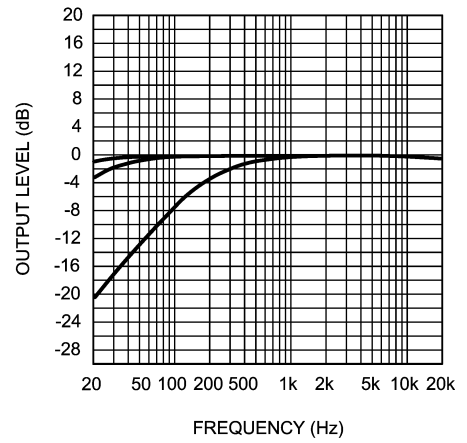

200942F3

## Application Information

### HIGH VOLTAGE BOOMER

Unlike previous 5V Boomer® amplifiers, the LM4951 is designed to operate over a power supply voltages range of 2.7V to 9V. Operating on a 7.5V power supply, the LM4951 will deliver 1.8W into an 8Ω BTL load with no more than 1% THD+N.

### BRIDGE CONFIGURATION EXPLANATION

As shown in Figure 1, the LM4951 consists of two operational amplifiers that drive a speaker connected between their outputs. The value of input and feedback resistors determine the gain of each amplifier. External resistors  $R_i$  and  $R_f$  set the closed-loop gain of AMP<sub>A</sub>, whereas two 20kΩ internal resistors set AMP<sub>B</sub>'s gain to -1. The LM4951 drives a load, such as a speaker, connected between the two amplifier outputs,  $V_{O+}$  and  $V_{O-}$ . Figure 1 shows that AMP<sub>A</sub>'s output serves as AMP<sub>B</sub>'s input. This results in both amplifiers producing signals identical in magnitude, but 180° out of phase. Taking advantage of this phase difference, a load is placed between AMP<sub>A</sub> and AMP<sub>B</sub> and driven differentially (commonly referred to as "bridge mode"). This results in a differential, or BTL, gain of

$$A_{VD} = 2(R_f / R_i) \quad (1)$$

Bridge mode amplifiers are different from single-ended amplifiers that drive loads connected between a single amplifier's output and ground. For a given supply voltage, bridge mode has a distinct advantage over the single-ended configuration: its differential output doubles the voltage swing across the load. Theoretically, this produces four times the output power when compared to a single-ended amplifier under the same conditions. This increase in attainable output power assumes that the amplifier is not current limited and that the output signal is not clipped. To ensure minimum output signal clipping when choosing an amplifier's closed-loop gain, refer to the **AUDIO POWER AMPLIFIER DESIGN** section. Under rare conditions, with unique combinations of high power supply voltage and high closed loop gain settings, the LM4951 may exhibit low frequency oscillations.

Another advantage of the differential bridge output is no net DC voltage across the load. This is accomplished by biasing AMP1's and AMP2's outputs at half-supply. This eliminates the coupling capacitor that single supply, single-ended amplifiers require. Eliminating an output coupling capacitor in a typical single-ended configuration forces a single-supply amplifier's half-supply bias voltage across the load. This increases internal IC power dissipation and may permanently damage loads such as speakers.

### POWER DISSIPATION

Power dissipation is a major concern when designing a successful bridged amplifier.

The LM4951's dissipation when driving a BTL load is given by Equation (2). For a 7.5V supply and a single 8Ω BTL load, the dissipation is 1.42W.

$$P_{DMAX-MONOBTL} = 4(V_{DD})^2 / 2\pi^2 R_L \quad \text{Bridge Mode} \quad (2)$$

The maximum power dissipation point given by Equation (2) must not exceed the power dissipation given by Equation (3):

$$P_{DMAX}' = (T_{JMAX} - T_A) / \theta_{JA} \quad (3)$$

The LM4951's  $T_{JMAX} = 150^\circ\text{C}$ . In the SD package, the LM4951's  $\theta_{JA}$  is  $73^\circ\text{C/W}$  when the metal tab is soldered to a copper plane of at least  $1\text{in}^2$ . This plane can be split between the top and bottom layers of a two-sided PCB. Connect the two layers together under the tab with an array of vias. At any given ambient temperature  $T_A$ , use Equation (3) to find the maximum internal power dissipation supported by the IC packaging. Rearranging Equation (3) and substituting  $P_{DMAX}'$  for  $P_{DMAX}$  results in Equation (4). This equation gives the maximum ambient temperature that still allows maximum stereo power dissipation without violating the LM4951's maximum junction temperature.

$$T_A = T_{JMAX} - P_{DMAX-MONOBTL}\theta_{JA} \quad (4)$$

For a typical application with a 7.5V power supply and a BTL 8Ω load, the maximum ambient temperature that allows maximum stereo power dissipation without exceeding the maximum junction temperature is approximately  $46^\circ\text{C}$  for the TS package.

$$T_{JMAX} = P_{DMAX-MONOBTL}\theta_{JA} + T_A \quad (5)$$

Equation (5) gives the maximum junction temperature  $T_{JMAX}$ . If the result violates the LM4951's  $150^\circ\text{C}$ , reduce the maximum junction temperature by reducing the power supply voltage or increasing the load resistance. Further allowance should be made for increased ambient temperatures.

The above examples assume that a device is operating around the maximum power dissipation point. Since internal power dissipation is a function of output power, higher ambient temperatures are allowed as output power or duty cycle decreases.

If the result of Equation (2) is greater than that of Equation (3), then decrease the supply voltage, increase the load impedance, or reduce the ambient temperature. Further, ensure that speakers rated at a nominal 8Ω do not fall below 6Ω. If these measures are insufficient, a heat sink can be added to reduce  $\theta_{JA}$ . The heat sink can be created using additional copper area around the package, with connections to the ground pins, supply pin and amplifier output pins. Refer to the **Typical Performance Characteristics** curves for power dissipation information at lower output power levels.

### POWER SUPPLY VOLTAGE LIMITS

Continuous proper operation is ensured by never exceeding the voltage applied to any pin, with respect to ground, as listed in the Absolute Maximum Ratings section.

### POWER SUPPLY BYPASSING

As with any power amplifier, proper supply bypassing is critical for low noise performance and high power supply rejection. Applications that employ a voltage regulator typically use a  $10\mu\text{F}$  in parallel with a  $0.1\mu\text{F}$  filter capacitors to stabilize the regulator's output, reduce noise on the supply line, and improve the supply's transient response. However, their presence does not eliminate the need for a local  $1.0\mu\text{F}$  tantalum bypass capacitance connected between the LM4951's supply pins and ground. Do not substitute a ceramic capacitor for the tantalum. Doing so may cause oscil-

## Application Information (Continued)

lation. Keep the length of leads and traces that connect capacitors between the LM4951's power supply pin and ground as short as possible. Connecting a larger capacitor,  $C_{\text{BYPASS}}$ , between the BYPASS pin and ground improves the internal bias voltage's stability and improves the amplifier's PSRR. The PSRR improvements increase as the bypass pin capacitor value increases. Too large, however, increases turn-on time and can compromise the amplifier's click and pop performance. The selection of bypass capacitor values, especially  $C_{\text{BYPASS}}$ , depends on desired PSRR requirements, click and pop performance (as explained in the section, **SELECTING EXTERNAL COMPONENTS**), system cost, and size constraints.

### MICRO-POWER SHUTDOWN

The LM4951 features an active-low micro-power shutdown mode. When active, the LM4951's micro-power shutdown feature turns off the amplifier's bias circuitry, reducing the supply current. The low 0.01 $\mu$ A typical shutdown current is achieved by applying a voltage to the SHUTDOWN pin that is as near to GND as possible. A voltage that is greater than GND may increase the shutdown current.

There are a few methods to control the micro-power shutdown. These include using a single-pole, single-throw switch (SPST), a microprocessor, or a microcontroller. When using a switch, connect the SPST switch between the shutdown pin and  $V_{\text{DD}}$ . Select normal amplifier operation by closing the switch. Opening the switch applies GND to the SHUTDOWN pin activating micro-power shutdown. The switch and internal pull-down resistor guarantee that the SHUTDOWN pin will not float. This prevents unwanted state changes. In a system with a microprocessor or a microcontroller, use a digital output to apply the active-state voltage to the SHUTDOWN pin.

### SELECTING EXTERNAL COMPONENTS

#### Input Capacitor Value Selection

Two quantities determine the value of the input coupling capacitor: the lowest audio frequency that requires amplification and desired output transient suppression.

As shown in Figure 1, the input resistor ( $R_i$ ) and the input capacitor ( $C_i$ ) produce a high pass filter cutoff frequency that is found using Equation (6).

$$f_c = 1/2\pi R_i C_i \quad (6)$$

As an example when using a speaker with a low frequency limit of 50Hz,  $C_i$ , using Equation (6) is 0.159 $\mu$ F. The 0.39 $\mu$ F  $C_{\text{INA}}$  shown in Figure 1 allows the LM4951 to drive high efficiency, full range speaker whose response extends below 30Hz.

#### OPTIMIZING CLICK AND POP REDUCTION PERFORMANCE

The LM4951 contains circuitry that eliminates turn-on and shutdown transients ("clicks and pops"). For this discussion, turn-on refers to either applying the power supply voltage or when the micro-power shutdown mode is deactivated.

As the  $V_{\text{DD}}/2$  voltage present at the BYPASS pin ramps to its final value, the LM4951's internal amplifiers are configured as unity gain buffers. An internal current source charges the capacitor connected between the BYPASS pin and GND in a controlled manner. Ideally, the input and outputs track the voltage applied to the BYPASS pin.

The gain of the internal amplifiers remains unity until the voltage on the bypass pin reaches  $V_{\text{DD}}/2$ . As soon as the voltage on the bypass pin is stable, there is a delay to prevent undesirable output transients ("click and pops"). After this delay, the device becomes fully functional.

### AUDIO POWER AMPLIFIER DESIGN

#### Audio Amplifier Design: Driving 1.8W into an 8 $\Omega$ BTL

The following are the desired operational parameters:

Power Output	1.8W <sub>RMS</sub>
Load Impedance	8 $\Omega$
Input Level	0.3V <sub>RMS</sub> (max)
Input Impedance	20k $\Omega$
Bandwidth	50Hz–20kHz $\pm$ 0.25dB

The design begins by specifying the minimum supply voltage necessary to obtain the specified output power. One way to find the minimum supply voltage is to use the *Output Power vs Power Supply Voltage* curve in the **Typical Performance Characteristics** section. Another way, using Equation (7), is to calculate the peak output voltage necessary to achieve the desired output power for a given load impedance. To account for the amplifier's dropout voltage, two additional voltages, based on the *Clipping Dropout Voltage vs Power Supply Voltage* in the **Typical Performance Characteristics** curves, must be added to the result obtained by Equation (7). The result is Equation (8).

$$V_{\text{opeak}} = \sqrt{(2R_L P_O)} \quad (7)$$

$$V_{\text{DD}} = V_{\text{OUTPEAK}} + V_{\text{ODTOP}} + V_{\text{ODBOT}} \quad (8)$$

The commonly used 7.5V supply voltage easily meets this. The additional voltage creates the benefit of headroom, allowing the LM4951 to produce peak output power in excess of 1.8W without clipping or other audible distortion. The choice of supply voltage must also not create a situation that violates of maximum power dissipation as explained above in the Power Dissipation section. After satisfying the LM4951's power dissipation requirements, the minimum differential gain needed to achieve 1.8W dissipation in an 8 $\Omega$  BTL load is found using Equation (9).

$$A_V \geq \sqrt{(P_O R_L)} / (V_{\text{IN}}) = V_{\text{orms}} / V_{\text{inrms}} \quad (9)$$

Thus, a minimum gain of 12.6 allows the LM4951's to reach full output swing and maintain low noise and THD+N performance. For this example, let  $A_{\text{V-BTL}} = 13$ . The amplifier's overall BTL gain is set using the input ( $R_i$ ) and feedback ( $R_f$ ) resistors of the first amplifier in the series BTL configuration. Additionally,  $A_{\text{V-BTL}}$  is twice the gain set by the first amplifier's  $R_i$  and  $R_f$ . With the desired input impedance set at 20k $\Omega$ , the feedback resistor is found using Equation (10).

$$R_f / R_i = A_{\text{V-BTL}} / 2 \quad (10)$$

The value of  $R_f$  is 130k $\Omega$  (choose 191k $\Omega$ , the closest value). The nominal output power is 1.8W.

## Application Information (Continued)

The last step in this design example is setting the amplifier's -3dB frequency bandwidth. To achieve the desired  $\pm 0.25$ dB pass band magnitude variation limit, the low frequency response must extend to at least one-fifth the lower bandwidth limit and the high frequency response must extend to at least five times the upper bandwidth limit. The gain variation for both response limits is 0.17dB, well within the  $\pm 0.25$ dB-desired limit. The results are an

$$f_L = 50\text{Hz} / 5 = 10\text{Hz} \quad (11)$$

and an

$$f_H = 20\text{kHz} \times 5 = 100\text{kHz} \quad (12)$$

As mentioned in the **SELECTING EXTERNAL COMPONENTS** section,  $R_i$  and  $C_i$  create a highpass filter that sets the amplifier's lower bandpass frequency limit. Find the coupling capacitor's value using Equation (13).

$$C_i = 1 / 2\pi R_i f_L \quad (13)$$

The result is

$$1 / (2\pi \times 20\text{k}\Omega \times 10\text{Hz}) = 0.795\mu\text{F}$$

Use a 0.82 $\mu$ F capacitor, the closest standard value.

The product of the desired high frequency cutoff (100kHz in this example) and the differential gain  $A_{VD}$ , determines the upper passband response limit. With  $A_{VD} = 7$  and  $f_H = 100\text{kHz}$ , the closed-loop gain bandwidth product (GBWP) is 700kHz. This is less than the LM4951's 3.5MHz GBWP. With this margin, the amplifier can be used in designs that require more differential gain while avoiding performance restricting bandwidth limitations.

### RECOMMENDED PRINTED CIRCUIT BOARD LAYOUT

Figures 2–4 show the recommended two-layer PC board layout that is optimized for the SD10A. This circuit is designed for use with an external 7.5V supply 8 $\Omega$  (min) speakers.

These circuit boards are easy to use. Apply 7.5V and ground to the board's  $V_{DD}$  and GND pads, respectively. Connect a speaker between the board's  $OUT_A$  and  $OUT_B$  outputs.

# Demonstration Board Layout

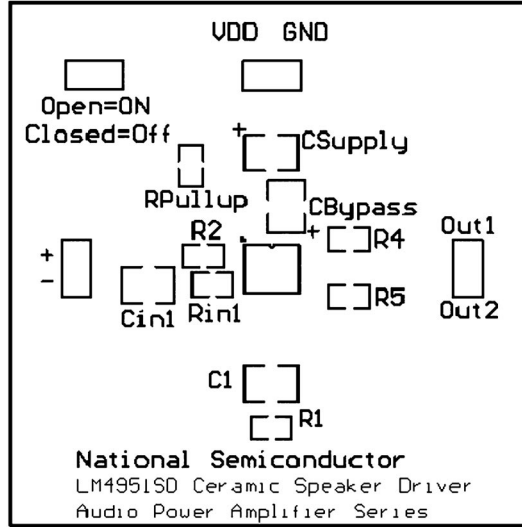

200942F8

FIGURE 2. Recommended TS SE PCB Layout:  
Top Silkscreen

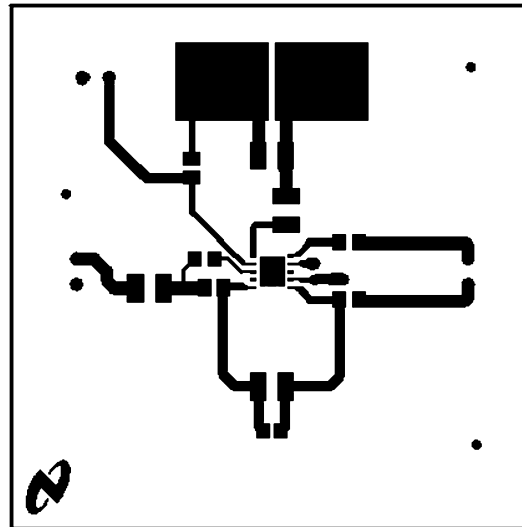

200942F7

FIGURE 3. Recommended TS SE PCB Layout:  
Top Layer

# Demonstration Board Layout (Continued)

www.DataSheet4U.com

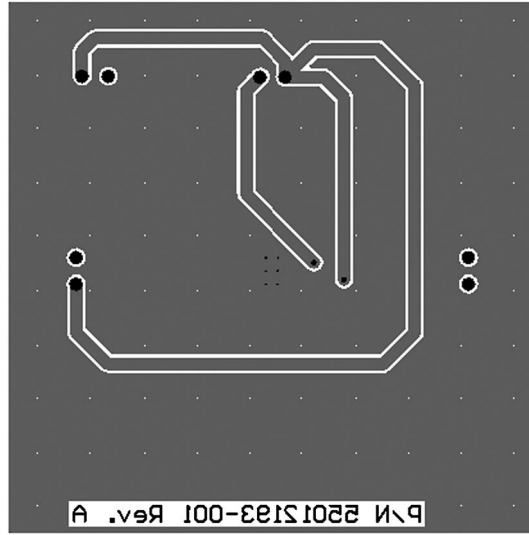

**FIGURE 4. Recommended TS SE PCB Layout:  
Bottom Layer**

## Revision History

[www.DataSheet4U.com](http://www.DataSheet4U.com)

Rev	Date	Description
1.0	5/19/05	Added the TL (LM4951TL) Mktg Outline per Nisha P.
1.1	6/13/05	Added the micro SMD pkg drawing.
1.2	7/12/05	Edited graphic F5, then re-released D/S to the WEB per Nisha P. (MC)
1.3	7/27/05	Changed the Typ values of eos ( on the 7.5V and 3.3V EC tables ) from 20 to 10, then re-released D/S to the WEB per Nisha P. (MC)
1.4	10/19/05	Text edits, then released D/S to the WEB.
1.5	10/26/05	Edited 200942 29, then re-released D/S to the WEB.
1.6	11/01/05	Added the X1, X2, and X3 values on the TLA09ZZA mktg outline, then re-released D/S to the WEB per Nisha.



**Physical Dimensions** inches (millimeters) unless otherwise noted

www.DataSheet4U.com

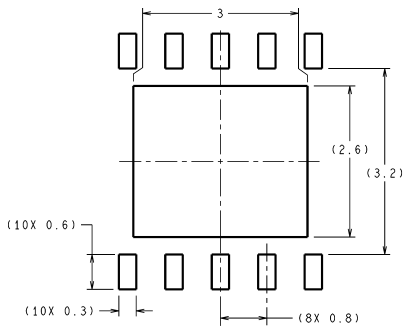

RECOMMENDED LAND PATTERN

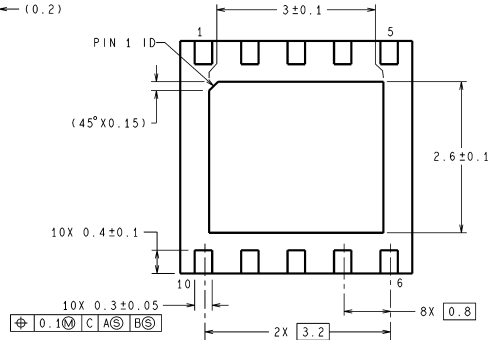
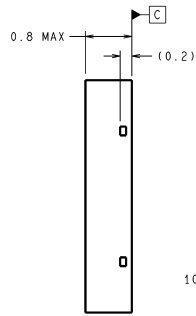
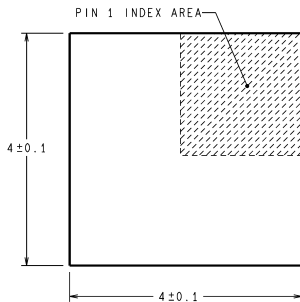

DIMENSIONS ARE IN MILLIMETERS

SDC10A (Rev A)

Order Number LM4951SD  
NS Package Number SDC10A

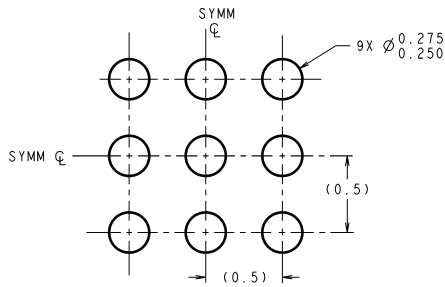

DIMENSIONS ARE IN MILLIMETERS  
DIMENSIONS IN ( ) FOR REFERENCE ONLY

LAND PATTERN RECOMMENDATION

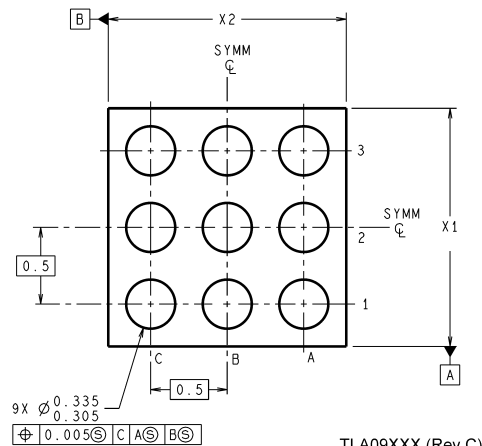
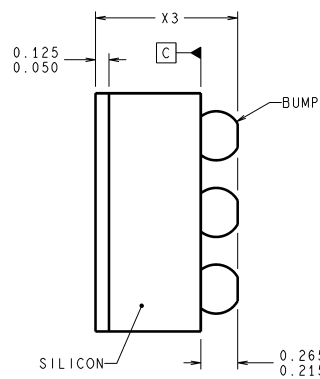
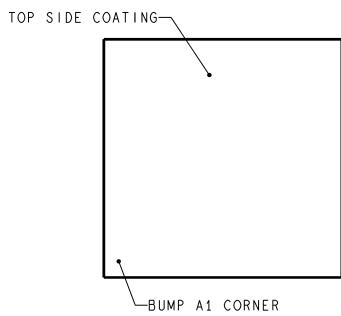

TLA09XXX (Rev C)

Order Number LM4951TL, TLX  
NS Package Number TLA09ZZA  
 $X_1 = 1.463 \pm 0.03$ ,  $X_2 = 1.463 \pm 0.03$ ,  $X_3 = 0.600 \pm 0.75$

Notes

National does not assume any responsibility for use of any circuitry described, no circuit patent licenses are implied and National reserves the right at any time without notice to change said circuitry and specifications.  
 For the most current product information visit us at [www.national.com](http://www.national.com).

**LIFE SUPPORT POLICY**

NATIONAL'S PRODUCTS ARE NOT AUTHORIZED FOR USE AS CRITICAL COMPONENTS IN LIFE SUPPORT DEVICES OR SYSTEMS WITHOUT THE EXPRESS WRITTEN APPROVAL OF THE PRESIDENT AND GENERAL COUNSEL OF NATIONAL SEMICONDUCTOR CORPORATION. As used herein:

1. Life support devices or systems are devices or systems which, (a) are intended for surgical implant into the body, or (b) support or sustain life, and whose failure to perform when properly used in accordance with instructions for use provided in the labeling, can be reasonably expected to result in a significant injury to the user.
2. A critical component is any component of a life support device or system whose failure to perform can be reasonably expected to cause the failure of the life support device or system, or to affect its safety or effectiveness.

**BANNED SUBSTANCE COMPLIANCE**

National Semiconductor manufactures products and uses packing materials that meet the provisions of the Customer Products Stewardship Specification (CSP-9-111C2) and the Banned Substances and Materials of Interest Specification (CSP-9-111S2) and contain no "Banned Substances" as defined in CSP-9-111S2.

Leadfree products are RoHS compliant.



**National Semiconductor  
Americas Customer  
Support Center**  
 Email: [new.feedback@nsc.com](mailto:new.feedback@nsc.com)  
 Tel: 1-800-272-9959

**National Semiconductor  
Europe Customer Support Center**  
 Fax: +49 (0) 180-530 85 86  
 Email: [europe.support@nsc.com](mailto:europe.support@nsc.com)  
 Deutsch Tel: +49 (0) 69 9508 6208  
 English Tel: +44 (0) 870 24 0 2171  
 Français Tel: +33 (0) 1 41 91 8790

**National Semiconductor  
Asia Pacific Customer  
Support Center**  
 Email: [ap.support@nsc.com](mailto:ap.support@nsc.com)

**National Semiconductor  
Japan Customer Support Center**  
 Fax: 81-3-5639-7507  
 Email: [jpn.feedback@nsc.com](mailto:jpn.feedback@nsc.com)  
 Tel: 81-3-5639-7560

[www.national.com](http://www.national.com)