



深圳市拓普微科技开发有限公司

SHENZHEN TOPWAY TECHNOLOGY CO., LTD.

LM6020BGW

LCD Module User Manual

Prepared by: Dong Date: 2014-1-6	Checked by: Date:	Approved by: Date:
---	----------------------------------	-----------------------------------

Rev.	Descriptions	Release Date
0.1	New release	2014-1-6

Table of Content

1. Basic Specifications	3
1.1 Display Specifications	3
1.2 Mechanical Specifications	3
1.3 Block Diagram	3
1.4 Terminal Functions	4
2. Absolute Maximum Ratings	5
3. Electrical Characteristics	5
3.1 DC Characteristics	5
3.2 LED Backlight Circuit Characteristics	5
3.3 AC Characteristics	6
4. Function specifications	7
4.1 Adjusting the Display Contrast	7
4.2 Basic Setting	7
4.3 Resetting the LCD module	7
4.3 Display Memory Map	8
4.4 Display Commands	9
4.5 Display Commands (continue)	10
5. Design and Handling Precaution	11

1. Basic Specifications

1.1 Display Specifications

- | | |
|---------------------|--|
| 1) LCD Display Mode | : FSTN, Negative, Transmissive |
| 2) Display Color | : Display Data = "1" : Light Gray (*2) |
| | : Display Data = "0" : Dark Gray(*1) |
| 3) Viewing Angle | : 6H |
| 4) Driving Method | : 1/65 duty, 1/9 bias |
| 5) Backlight | : White LED backlight |

Note:

*1. Color tone may slightly change by Temperature and Driving Condition.

*2. The Color is defined as the inactive / background color

*3. Fine Contrast adjustment function is necessary in the application design for optimal display result.

1.2 Mechanical Specifications

- | | |
|----------------------|--|
| 1) Outline Dimension | : 45.0x 32.0 x 14.8MAX (mm)(exclude FFC) |
| | (See attached Outline Drawing for details) |

1.3 Block Diagram

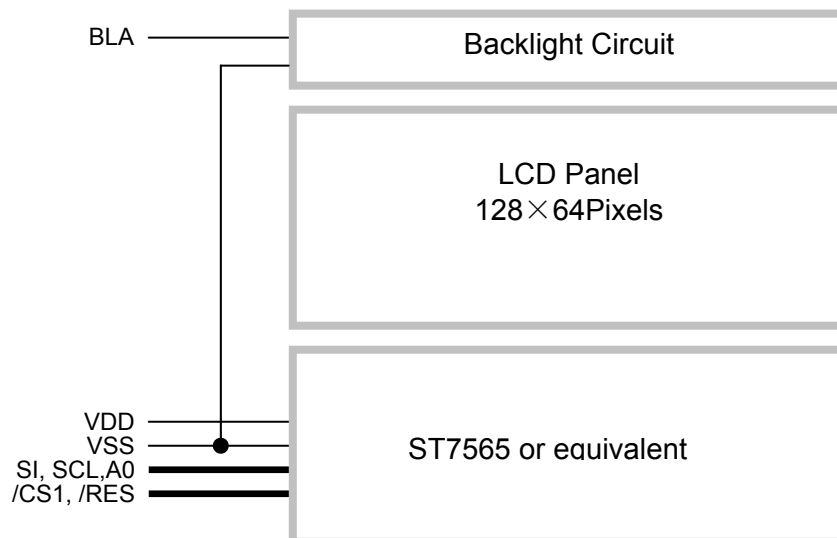

1.4 Terminal Functions

Pin No.	PIN Name	I/O	Descriptions
1	VSS	Power	Negative power supply,0V
2	VDD	Power	Positive power supply
3	SI	I/O	Serial data input
4	SCL	Input	Serial clock input
5	NC	-	No connection,leave open
:	:	:	:
12	NC	-	No connection,leave open
13	A0	Input	Register Select A0 = H, Transferring the Display Data A0 = L, Transferring the Control Data
14	/RES	Input	Reset signal /RES = L, Initialization is executed /RES = H, Normal running.
15	/CS1	Input	Chip Select /CS1=L, enable access to the LCD interface /CS1=H, disable access to the LCD interface
16	BLA	Power	Positive power for LED backlight

2. Absolute Maximum Ratings

Items	Symbol	Min.	Max.	Unit	Condition
Supply Voltage	V_{DD}	-0.3	+3.4	V	$V_{SS} = 0V$
Input Voltage	V_{IN}	-0.3	$V_{DD}+0.3$	V	$V_{SS} = 0V$
Operating Temperature	T_{OP}	-20	+70	°C	No Condensation
Storage Temperature	T_{ST}	-30	+80	°C	No Condensation

Cautions:

Any Stresses exceeding the Absolute Maximum Ratings may cause substantial damage to the device. Functional operation of this device at other conditions beyond those listed in the specification is not implied and prolonged exposure to extreme conditions may affect device reliability.

3. Electrical Characteristics

3.1 DC Characteristics

$V_{SS}=0V, V_{DD}=3.3V, T_{OP}=25^{\circ}C$

Items	Symbol	MIN.	TYP.	MAX.	Unit	Condition / Application Pin
Operating Voltage	V_{DD}	2.9	3.3	3.4	V	VDD
Input High Voltage	V_{IH}	$0.8 \times V_{DD}$	-	V_{DD}	V	/RES, /CS1, A0,
Input Low Voltage	V_{IL}	V_{SS}	-	$0.2 \times V_{DD}$	V	DB0-DB7
Operating Current	I_{DD}	-	0.2	0.5	mA	VDD

3.2 LED Backlight Circuit Characteristics

$V_{SS}=0V, I_{f_{BLA}}=34mA, T_{OP}=25^{\circ}C$

Items	Symbol	MIN.	TYP.	MAX.	Unit	Applicable Pin
Forward Voltage	$V_{f_{BLA}}$	-	3.3	-	V	BLA
Forward Current	$I_{f_{BLA}}$	-	34	40	mA	BLA

Cautions:

Exceeding the recommended driving current could cause substantial damage to the backlight and shorten its lifetime.

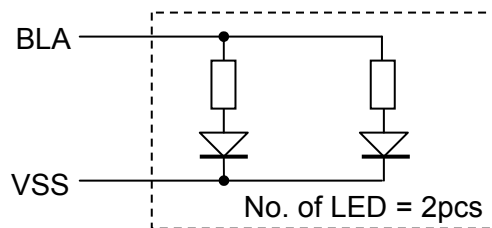

3.3 AC Characteristics

3.3.1 Serial Mode Interface

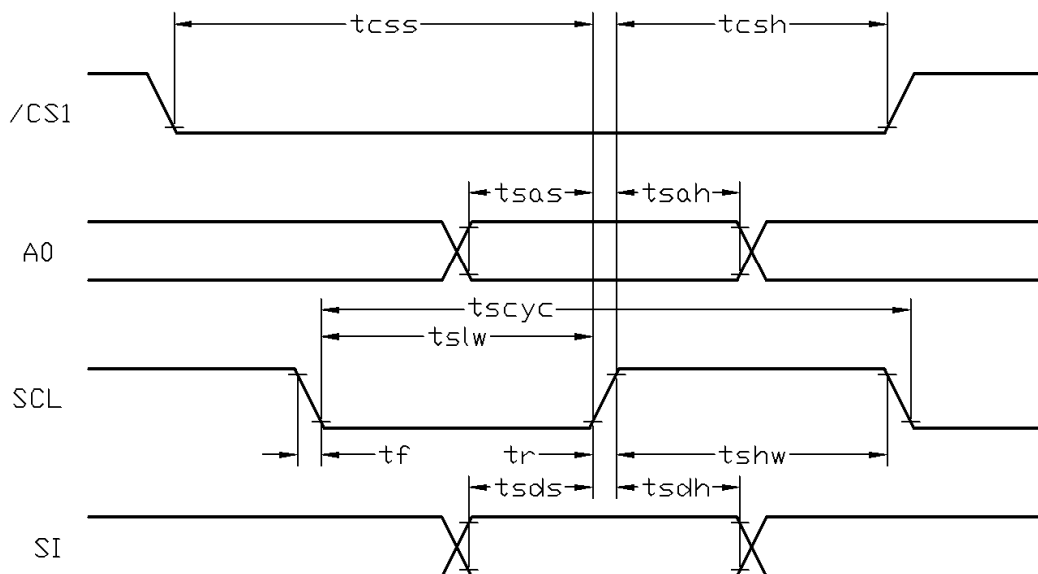

$V_{SS}=0V, V_{DD}=3.0V, T_{OP}=25^{\circ}C$

Item	Symbol	MIN.	TYP.	MAX.	Unit
Serial Clock Period	tscyc	65	-	-	ns
Address setup time (A0)	tsas	26	-	-	ns
Address hold time (A0)	tsah	13	-	-	ns
SCL "H" pulse width	tshw	33	-	-	ns
SCL "L" pulse width	tslw	33	-	-	ns
Data setup time	tsds	26	-	-	ns
Data hold time	tsdh	25	-	-	ns
CS-SCL time	tcss	26	-	-	ns
CS-SCL time	tcsh	52	-	-	ns

Note:

*1. Input signal rise/fall time should be less than 15ns .

*2. CL=100pF

*3.All timing is using 20% and 80% of VDD as the reference.

3.3.2 Reset Timing

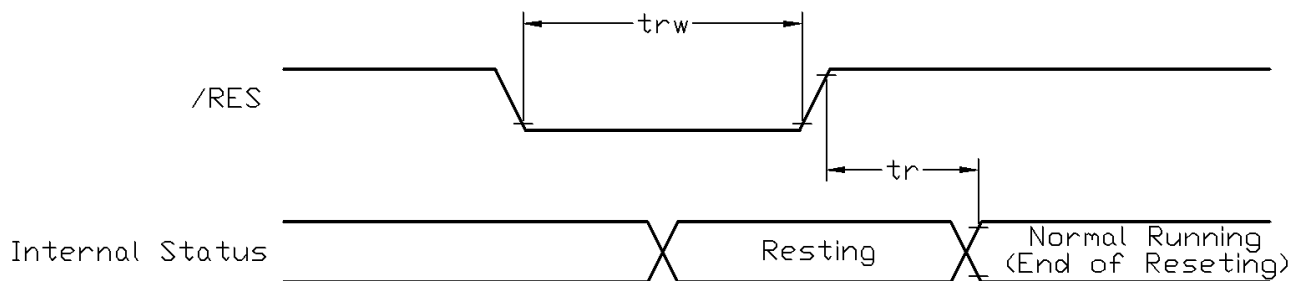

$V_{SS}=0V, V_{DD}=3.0V, T_{OP}=25^{\circ}C$

Item	Symbol	MIN.	TYP.	MAX.	Unit
Reset time	tr	-	-	1.3	μs
Reset LOW pulse width	trw	1.3	-	-	μs

Note:

*1.All timing is using 20% and 80% of VDD as the reference.

4. Function specifications

4.1 Adjusting the Display Contrast

- This LCD module equipped with latest digital contrast adjustment function.
- Its display contrast could be adjusted by MCU command. (please see the command tables for details)
- It is recommended to provide a contrast adjustment interface for end-user, where the best display result could meet the individual preference in mass production.

4.2 Basic Setting

To drive the LCD module correctly and provide normally display, please use the following setting

- ADC = 0 (normal)
- SHL select = 1 (reverse)
- LCD Bias Select = 1/9
- Initial Display Line = 0
- Entire Display ON/OFF = OFF (normal)
- Reverse Display ON/OFF = OFF (normal)
- Set Power Control Set:
 - voltage follower = ON, voltage converter = ON, voltage regulator = ON
- Display ON/OFF = ON

Note:

*1. These setting/commands should issue the LCD module while start up.

*2. See the Display Commands section for details.

4.3 Resetting the LCD module

The LCD module should be initialized by using /RES terminal.

While turning on the VDD and VSS power supply, maintain /RES terminal at LOW level. After the power supply stabilized, release the reset terminal (/RES=HIGH)

4.3 Display Memory Map

Page address	data	LCD Display (front view)	
0	D0 : D7	128x64 pixels	
1	D0 : D7		
2	D0 : D7		
3	D0 : D7		
4	D0 : D7		
5	D0 : D7		
6	D0 : D7		
7	D0 : D7		
Column Address		00h	→ 7Fh

Note:

*1. ADC = 0 (normal)

*2. SHL Selection = 1 (reverse)

*3. Initial Display Line = 0

4.4 Display Commands

No.	Instructions	Code											Function
		a0	/RD	/WR	D7	D6	D5	D4	D3	D2	D1	D0	
1	Display ON/OFF	0	1	0	1	0	1	0	1	1	1	DON	DON=0, display off DON=1, display on
2	Display start line set	0	1	0	0	1	Display start address						Sets the display RAM display start line address
3	Set Page Address	0	1	0	1	0	1	1	Page Address				Set the display RAM page address
4	Set Column Address (Upper-4-bits)	0	1	0	0	0	0	1	Col. Add. Upper				Set the upper-4-bit of column address counter
	Set Column Address (Lower-4-bits)	0	1	0	0	0	0	0	Col. Add. Lower				Set the lower-4-bit of column address counter
5	Read Status	0	0	1	Status				0	0	0	0	Read the status data
6	Write Display Data	1	1	0	Write Data								Write data into the display RAM
7	Read Display Data	1	0	1	Read Data								Read data from the display RAM
8	ADC Select	0	1	0	1	0	1	0	0	0	0	ADC	Sets the display RAM address SEG output correspondence ADC= 0,normal . ADC=1, reverse
9	Normal/Reverse Display	0	1	0	1	0	1	0	0	1	1	REV	REV=0, Normal display REV=1, Reverse display
10	Entire Display ON/OFF	0	1	0	1	0	1	0	0	1	0	EON	EON=0, Normal display EON=1, Entire display ON
11	Set LCD Bias	0	1	0	1	0	1	0	0	0	1	BIAS	Set the LCD driving voltage bias BIAS=0, 1/9 BIAS BIAS=1, 1/7 BIAS
12	Set Read-Modify-Write	0	1	0	1	1	1	0	0	0	0		Enter the "Read-Modify-Write" mode column address counter will increase in each "Write Display Data", and will not increase in each "Read Display Data command"
13	Reset Read-Modify-Write	0	1	0	1	1	1	0	1	1	1	0	Clear the "Read-Modify-Write" mode
14	Reset	0	1	0	1	1	1	0	0	0	1	0	Resets the LCD module
15	SHL Select	0	1	0	1	1	0	0	SHL	*	*	*	Set the COM scanning direction SHL=0, Normal display SHL=1, Flipped in y direction * = don't care terms
16	Power Control Set	0	1	0	0	0	1	0	1	VC	VR	VF	Set the power circuit operation mode VF: LCD Supply Voltage Follower VR: LCD Supply Voltage Regulator VC: LCD Supply Voltage Converter (1=ON, 0=OFF)
17	Regulator Resistor Select	0	1	0	0	0	1	0	0	Radio setting			Set the built-in resistor ratio (Rb/Ra)

4.5 Display Commands (continue)

No.	Instructions	Code										Function	
		A0	/RD	/WR	D7	D6	D5	D4	D3	D2	D1		D0
18	Electronic volume mode set	0	1	0	1	0	0	0	0	0	0	1	Set reference voltage mode
	Electronic volume register set	0	1	0	*	*	Electronic Control value					Set reference voltage register (Display contrast value)	
19	Sleep Mode Set	0	1	0	1	0	1	0	1	1	0	S	Sleep Mode (2 byte command) S=0, sleep mode S=1, normal mode
		0	1	0	0	0	0	0	0	0	0	0	
20	Booster Ratio Set	0	1	0	1	1	1	1	1	0	0	0	Booster Ratio (2 byte command) Ratio=00, 2x, 3x, 4x
		0	1	0	0	0	0	0	0	0	0	Ratio	Ratio=01, 5x Ratio=11, 6x
21	NOP	0	1	0	1	1	1	0	0	0	1	1	Non-operation command

Note: *1. Do not use any other command not listed, or the system malfunction may result.
*2. For the details of the Display Commands, please refer to ST7565R data sheet.

4.5.1 Power off the LCD Module

It recommends that enter Sleep Mode before power off the LCD module.

4.5.2 Refreshing The LCD Module

It recommends that the operating modes and display contents be refreshed periodically to prevent the effect of unexpected noise.

5. Design and Handling Precaution

1. The LCD panel is made by glass. Any mechanical shock (eg. dropping from high place) will damage the LCD module.
2. Do not add excessive force on the surface of the display, which may cause the Display color change abnormally.
3. The polarizer on the LCD is easily get scratched. If possible, do not remove the LCD protective film until the last step of installation.
4. Never attempt to disassemble or rework the LCD module.
5. Only Clean the LCD with Isopropyl Alcohol or Ethyl Alcohol. Other solvents (eg. water) may damage the LCD.
6. When mounting the LCD module, make sure that it is free from twisting, warping and distortion.
7. Ensure to provide enough space (with cushion) between case and LCD panel to prevent external force adding on it, or it may cause damage to the LCD or degrade the display result.
8. Only hold the LCD module by its side. Never hold LCD module by add force on the heat seal or TAB.
9. Never add force to component of the LCD module. It may cause invisible damage or degrade of the reliability.
10. LCD module could be easily damaged by static electricity. Be careful to maintain an optimum anti-static work environment to protect the LCD module.
11. When peeling off the protective film from LCD, static charge may cause abnormal display pattern. It is normal and will resume to normal in a short while.
12. Take care and prevent get hurt by the LCD panel sharp edge.
13. Never operate the LCD module exceed the absolute maximum ratings.
14. Keep the signal line as short as possible to prevent noisy signal applying to LCD module.
15. Never apply signal to the LCD module without power supply.
16. IC chip (eg. TAB or COG) is sensitive to the light. Strong lighting environment could possibly cause malfunction. Light sealing structure casing is recommend.
17. LCD module reliability may be reduced by temperature shock.
18. When storing the LCD module, avoid exposure to the direct sunlight, high humidity, high temperature or low temperature. They may damage or degrade the LCD module

FFC Terminal No	Pin Name
1	VSS
2	VDD
3	SI
4	SCL
5	NC
6	NC
7	NC
8	NC
9	NC
10	NC
11	NC
12	NC
13	A0
14	/RES
15	/CS1
16	BLA

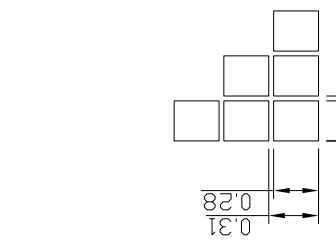

Pixels Details
Scale=30/1

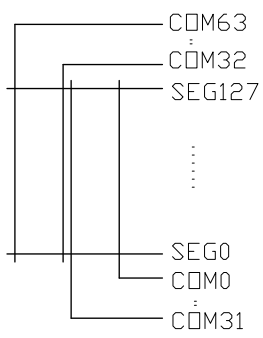
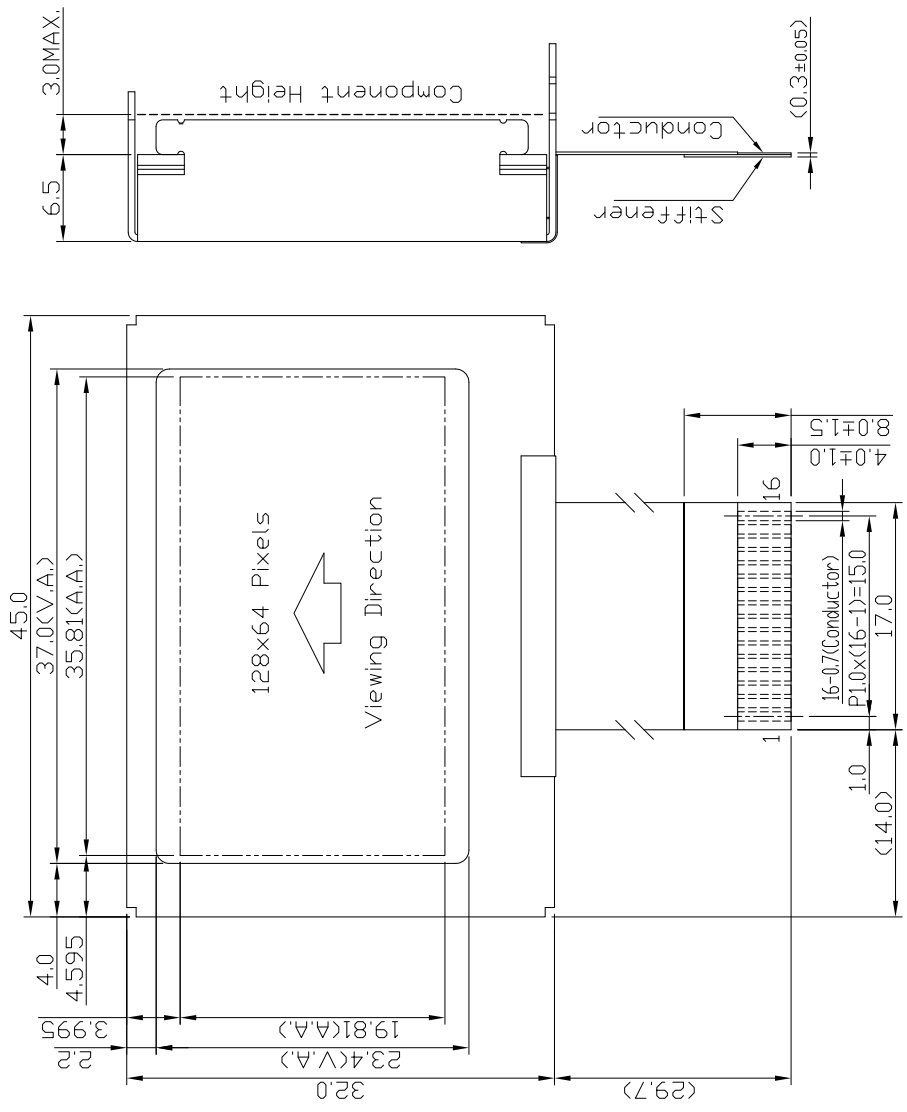
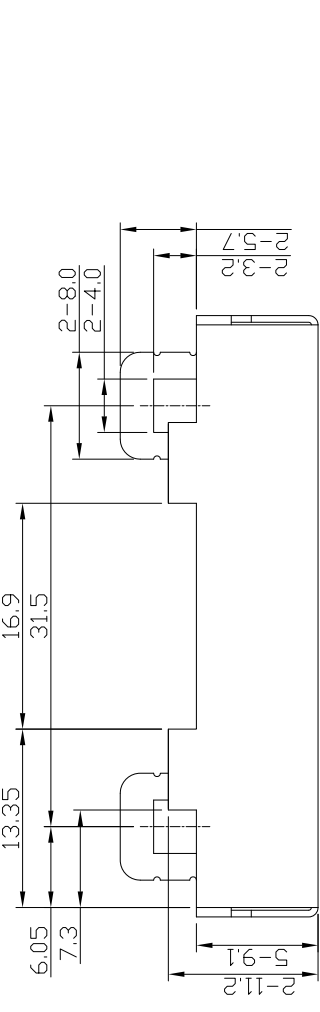

Wiring Details
(Top View)
Scale=free.

C
B
A

Rev/Note	Date
Dwg Title	LM6020BGW Outline Dwg
Dwg No.	MK-004588-1-1
Date	2013-9-17
Scale	5/2
Tol.	±0.5
Unit	mm
Paper Size	A3
Checked	
Drawn	Zhou

- Note:
- *1. Display Type : FSTN, Negative, Transmissive
 - *2. Viewing Direction : 6H
 - *3. Duty : 1/65, Bias : 1/9
 - *4. Operating Voltage : 3.3V
 - *5. Backlight Supply : 3.3V TYP.
 - *6. Backlight Color : White
 - *7. Operating Temperature : -20°C~70°C
 - *8. Storage Temperature : -30°C~80°C

