

LM715 High Speed Operational Amplifier

General Description

The LM715 is a high speed, high gain, monolithic operational amplifier intended for use in a wide range of applications where fast signal acquisition or wide bandwidth is required. The LM715 features fast settling time, high slew rate, low offsets, and high output swing for large signal applications. In addition, the device displays excellent temperature stability and will operate over a wide range of supply voltages.

Features

- High slew rate— 100 V/ μ s (Inverting, $A_V = 1$) typically
- Fast settling time— 800 ns typically
- Wide bandwidth— 65 MHz typically
- Wide operating supply range
- Wide input voltage ranges

Applications

- Video amplifiers
- Active filters
- High speed data conversion

Connection Diagrams

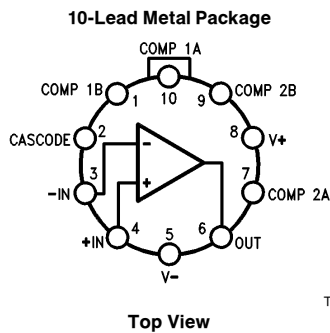

Lead 5 connected to case.

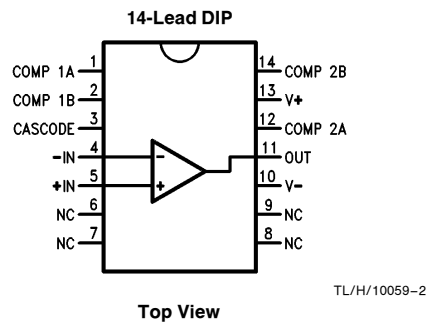

Ordering Information

Device Code	Package Code	Package Description
LM715MH	H10C	Metal
LM715CH	H10C	Metal
LM715MJ	J14A	Ceramic DIP
LM715CJ	J14A	Ceramic DIP

Absolute Maximum Ratings

If Military/Aerospace specified devices are required, please contact the National Semiconductor Sales Office/Distributors for availability and specifications.

Storage Temperature Range	-65°C to +175°C
Operating Temperature Range	
Extended (LM715M)	-55°C to +125°C
Commercial (LM715C)	0°C to +70°C
Lead Temperature	
Metal Can and Ceramic DIP	
(Soldering, 60 sec.)	300°C

Internal Power Dissipation (Notes 1, 2)

10L-Metal Can	1.07W
14L-Ceramic DIP	1.36W
Supply Voltage	±18V
Differential Input Voltage	±5V
Input Voltage (Note 3)	±15V

LM715M and LM715C

Electrical Characteristics $T_A = 25^\circ\text{C}$, $V_{CC} = \pm 15\text{V}$, unless otherwise specified

Symbol	Parameter	Conditions	LM715M			LM715C			Units
			Min	Typ	Max	Min	Typ	Max	
V_{IO}	Input Offset Voltage	$R_S \leq 10\text{ k}\Omega$		2.0	5.0		2.0	7.5	mV
I_{IO}	Input Offset Current			70	250		70	250	nA
I_{IB}	Input Bias Current			400	750		400	1500	nA
Z_I	Input Impedance			1.0			1.0		M Ω
R_O	Output Resistance			75			75		Ω
I_{CC}	Supply Current			5.5	7.0		5.5	10	mA
P_C	Power Consumption			165	210		165	300	mW
V_{IR}	Input Voltage Range		±10	±12		±10	±12		V
A_{VS}	Large Signal Voltage Gain	$R_L \geq 2.0\text{ k}\Omega$, $V_O = \pm 10\text{V}$	15	30		10	30		V/mV
V	Settling Time	$V_O = \pm 5.0\text{V}$, $A_V = 1.0$		800			800		ns
TR	Transient Response	Rise Time		30	60		30	75	ns
		Overshoot		25	40		25	50	%
SR	Slew Rate	$A_V = 100$		70			70		V/ μs
		$A_V = 10$		38			38		
		$A_V = 1.0$ (Non-Inverting)	15	18		10	18		
		$A_V = 1.0$ (Inverting)		100			100		

The following specifications apply over the range of $-55^\circ\text{C} \leq T_A \leq +125^\circ\text{C}$ for the LM715M, and $0^\circ\text{C} \leq T_A \leq +70^\circ\text{C}$ for the LM715C

Symbol	Parameter	Conditions	LM715M			LM715C			Units
			Min	Typ	Max	Min	Typ	Max	
V_{IO}	Input Offset Voltage	$R_S \leq 10\text{ k}\Omega$			7.5			10	mV
I_{IO}	Input Offset Current	$T_A = T_{A\text{ Max}}$			250			250	nA
		$T_A = T_{A\text{ Min}}$			800			750	
I_{IB}	Input Bias Current	$T_A = T_{A\text{ Max}}$			0.75			1.5	μA
		$T_A = T_{A\text{ Min}}$			4.0			7.5	
CMR	Common Mode Rejection	$R_S \leq 10\text{ k}\Omega$	74	92		74 (Note 4)	92 (Note 4)		dB
PSRR	Power Supply Rejection Ratio	$R_S \leq 10\text{ k}\Omega$		45	300		45 (Note 4)	400 (Note 4)	$\mu\text{V}/\text{V}$
A_{VS}	Large Signal Voltage Gain	$R_L \geq 2.0\text{ k}\Omega$, $V_O = \pm 10\text{V}$	10			8			V/mV
V_{OP}	Output Voltage Swing	$R_L = 2.0\text{ k}\Omega$	±10	±13		±10	±13		V

Note 1: $T_{J\text{ Max}} = 175^\circ\text{C}$.

Note 2: Ratings apply to ambient temperature at 25°C . Above this temperature, derate the 10L-Metal Can at $7.1\text{ mW}/^\circ\text{C}$, and the 14L-Ceramic DIP at $9.1\text{ mW}/^\circ\text{C}$.

Note 3: For supply voltages less than $\pm 15\text{V}$, the absolute maximum input voltage is equal to the supply voltage.

Note 4: $T_A = 25^\circ\text{C}$ only.

Typical Performance Characteristics for LM715M and LM715C

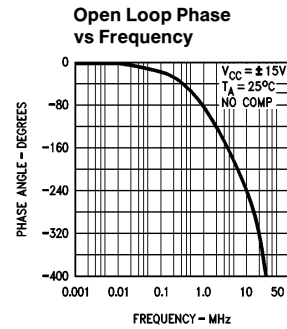
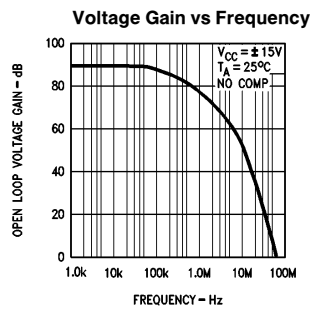
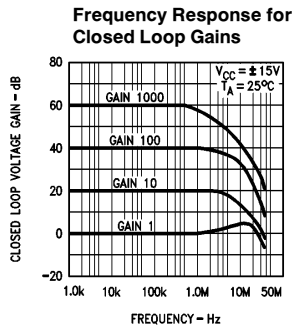
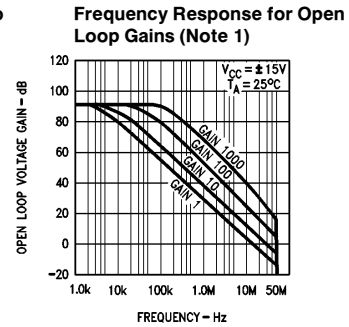
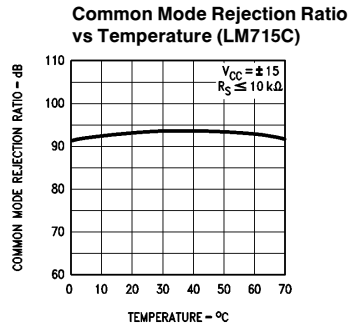
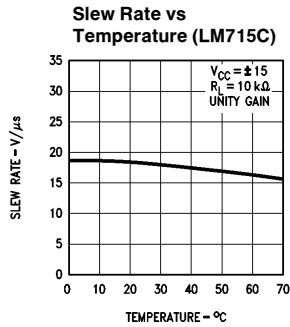
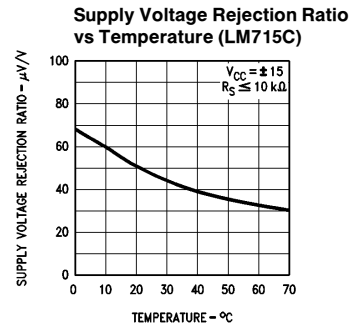
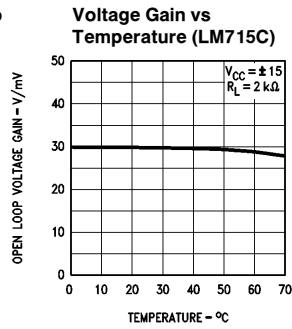
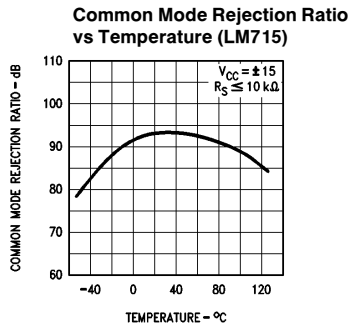
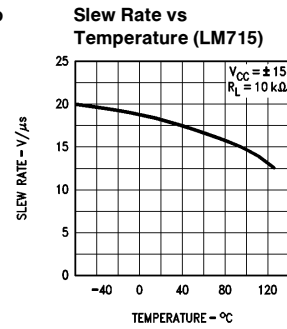
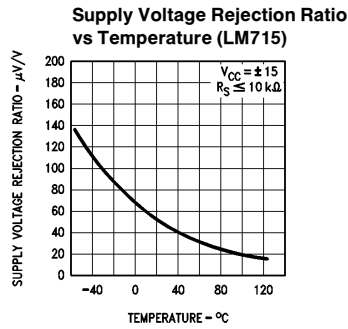
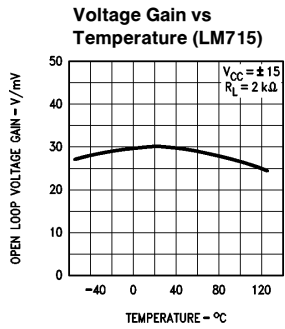

Note 1: See "Non-Inverting Compensation Components Value Table" for Closed Loop Gain values.

TL/H/10059-4

Typical Performance Characteristics for LM715M and LM715C (Continued)

Output Swing vs Frequency for Closed Loop Gains

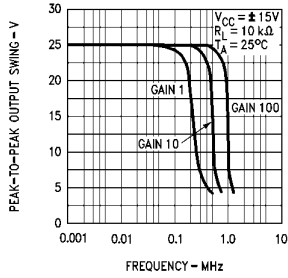

Supply Voltage Rejection Ratio vs Frequency

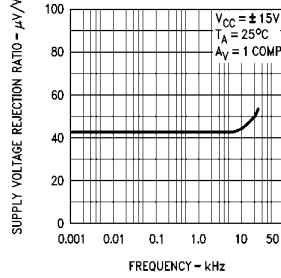

Common Mode Rejection Ratio vs Frequency

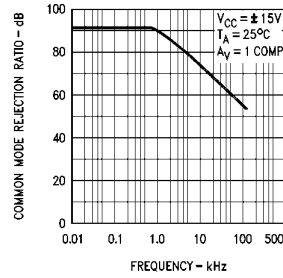

Unity Gain Large Signal Pulse Response

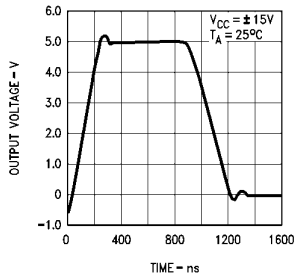

Large Signal Pulse Response for Gain 10

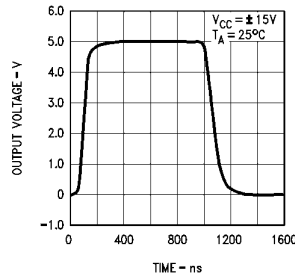

Large Signal Pulse Response for Gain 100

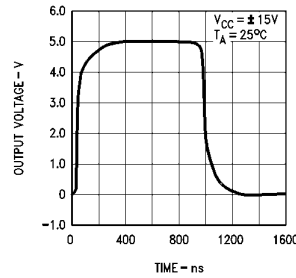

Slew Rate vs Closed Loop Voltage Gain

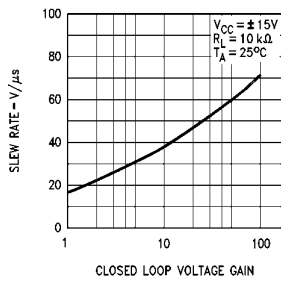

Slew Rate vs Supply Voltage

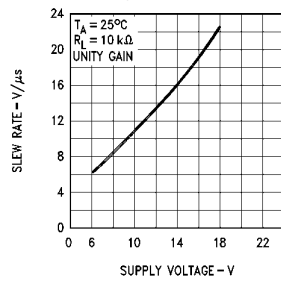

Voltage Follower Transient Response

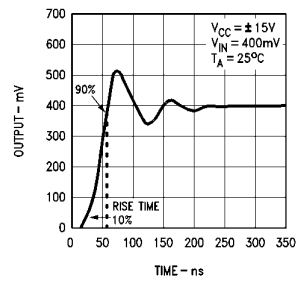

Inverting Unity Gain Large Signal Pulse Response

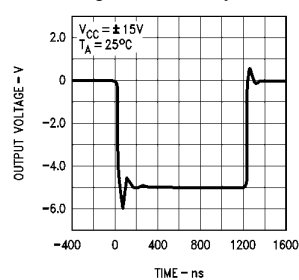

Small Signal Pulse Response Inverting Unity Gain

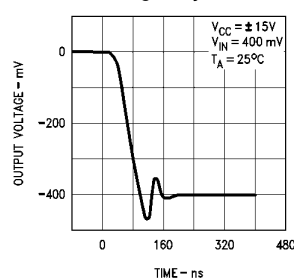

TL/H/10059-5

Typical Performance Characteristics for LM715M and LM715C (Continued)

Voltage Follower (Note 2)

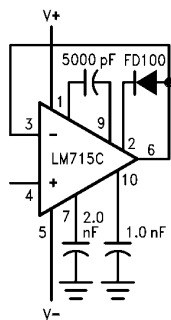

TL/H/10059-6

Voltage Offset Null Circuit (Note 2)

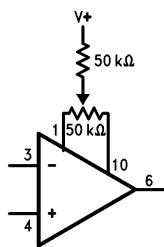

TL/H/10059-7

High Slew Rate Circuit (Note 2)

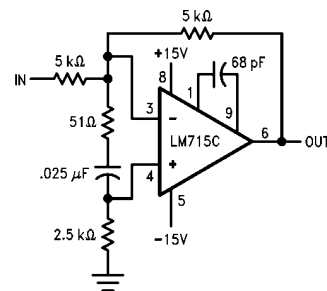

TL/H/10059-8

Note 2: Lead numbers apply to metal package.

Equivalent Circuit

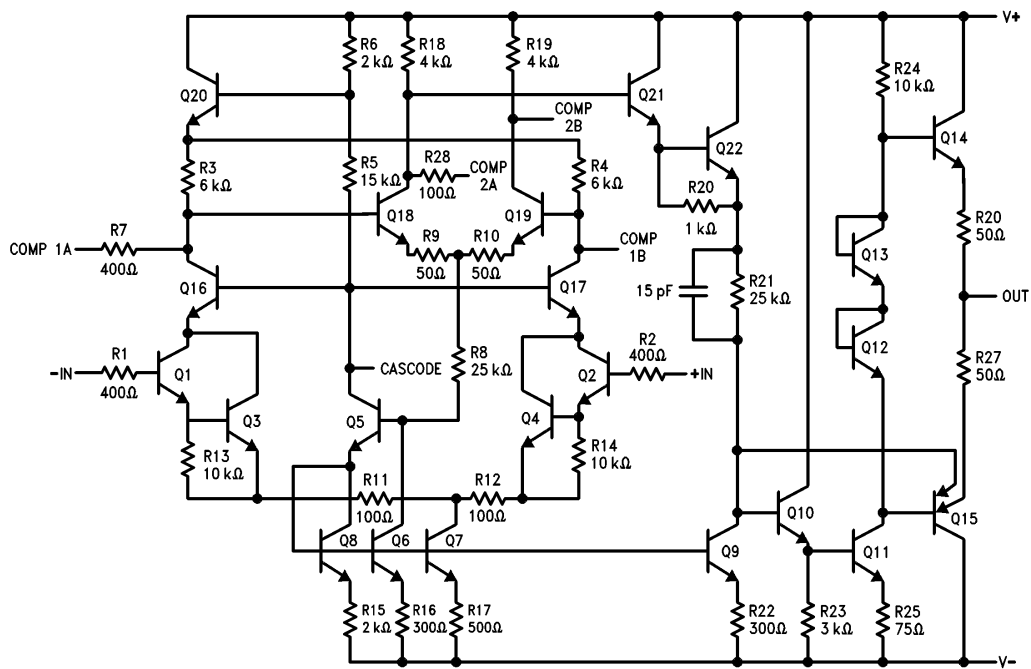

TL/H/10059-3

Applications Information

Non-Inverting Compensation Components Values

Closed Loop Gain	C1	C2	C3
1000	10 pF		
100	50 pF		250 pF
10 (Note)	100 pF	500 pF	1000 pF
1	500 pF	2000 pF	1000 pF

Note: For gain 10, compensation may be simplified by removing C2, C3 and adding a 200 pF capacitor (C4) between Lead 7 and 10.

Frequency Compensation Circuit

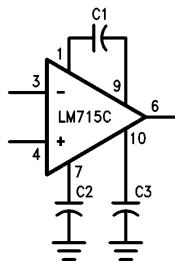

TL/H/10059-9

Suggested Values of Compensation Capacitors vs Closed Loop Voltage Gain

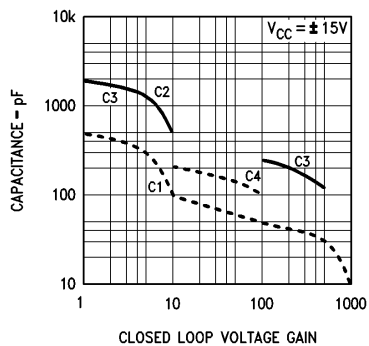

TL/H/10059-10

Layout Instructions

Layout—The layout should be such that stray capacitance is minimal.

Supplies—The supplies should be adequately bypassed. Used of 0.1 μ F high quality ceramic capacitors is recommended.

Note: All lead numbers on this page apply to metal package.

Ringing—Excessive ringing (long acquisition time) may occur with large capacitive loads. This may be reduced by isolating the capacitive load with a resistance of 100 Ω . Large source resistances may also give rise to the same problem and this may be decreased by the addition of a capacitance across the feedback resistance. A value of around 50 pF for unity gain configuration and around 3.0 pF for gain 10 should be adequate.

Latch Up—This may occur when the amplifier is used as a voltage follower. The inclusion of a diode between leads 6 and 2 with the cathode toward lead 2 is the recommended preventive measure.

Typical Applications

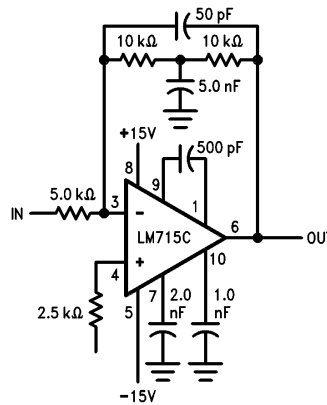

TL/H/10059-14

High Speed Integrator

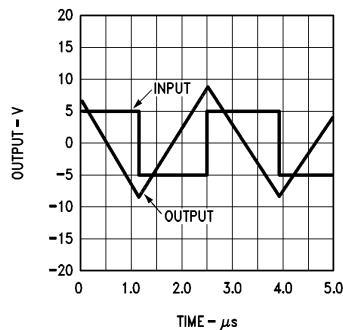

TL/H/10059-13

Typical Applications (Continued)

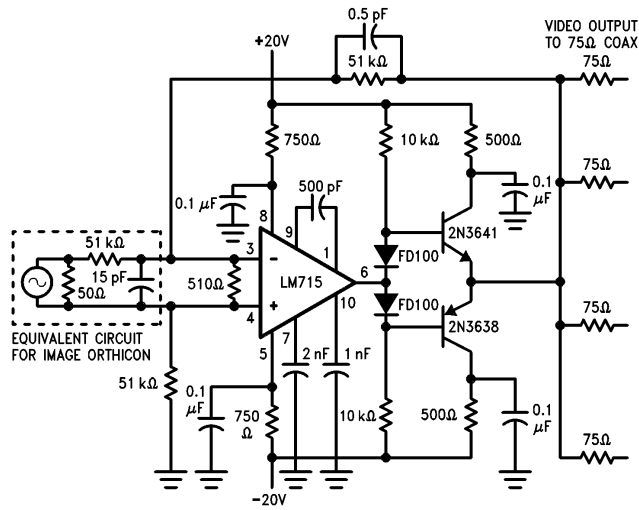

TL/H/10059-12

Note: All lead numbers shown refer to metal package.

Wide Band Video Amplifier Drive Capability with 75Ω Coax Cable

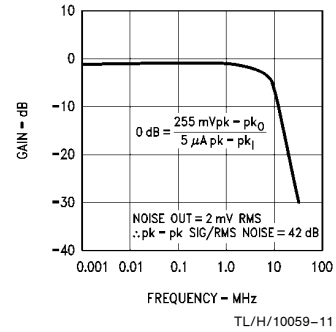

Physical Dimensions inches (millimeters)

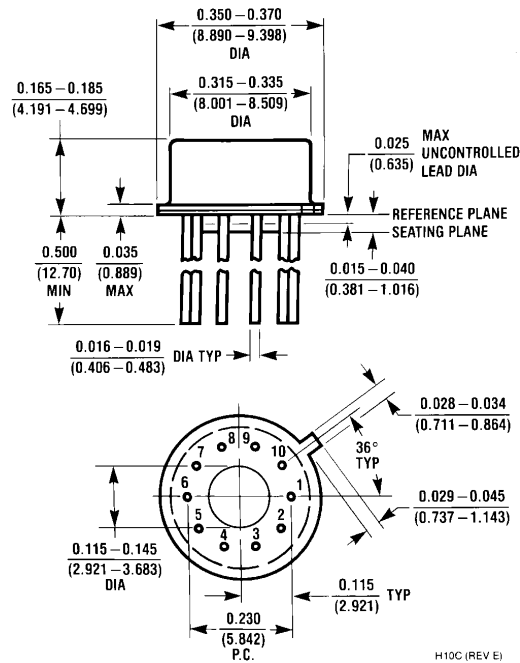

10-Lead Metal Can Package (H)
Order Number LM715CH or LM715MH
NS Package Number H10C

