



# LM7800 Series 3-Terminal Fixed Voltage Regulators

## THREE-TERMINAL POSITIVE VOLTAGE REGULATORS

These voltage regulators are monolithic integrated circuits designed as fixed-voltage regulators for a wide variety of applications including local, on-card regulation. These regulators employ internal current limiting, thermal shutdown, and safe-area

compensation. With adequate heatsinking they can deliver output currents in excess of 1.5 ampere.

Although designed primarily as a fixed voltage regulator, these devices can be used with external components to obtain adjustable voltages and currents.

### FEATURES

- Output Current in Excess of 1.5 Ampere
- No External Components Required
- Internal Thermal Overload Protection
- Internal Short-Circuit Current Limiting
- Output Transistor Safe-Area Compensation
- Output Voltage Offered in 2% Tolerance

### PIN ARRANGEMENT

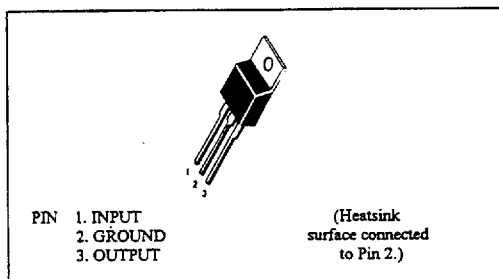

### CIRCUIT SCHEMATIC

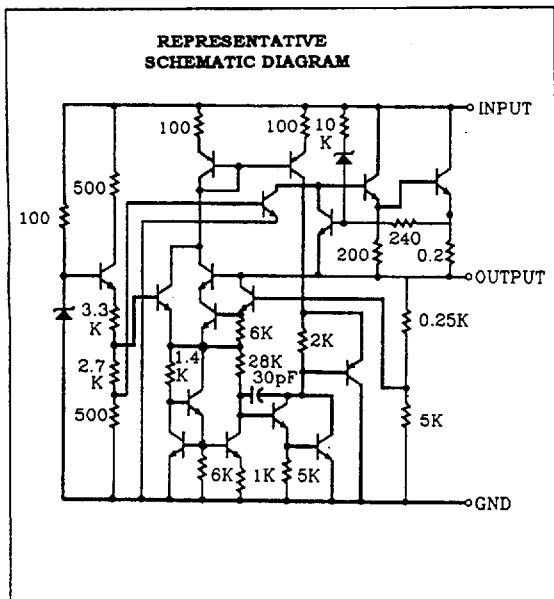

### TYPICAL CONNECTING CIRCUIT

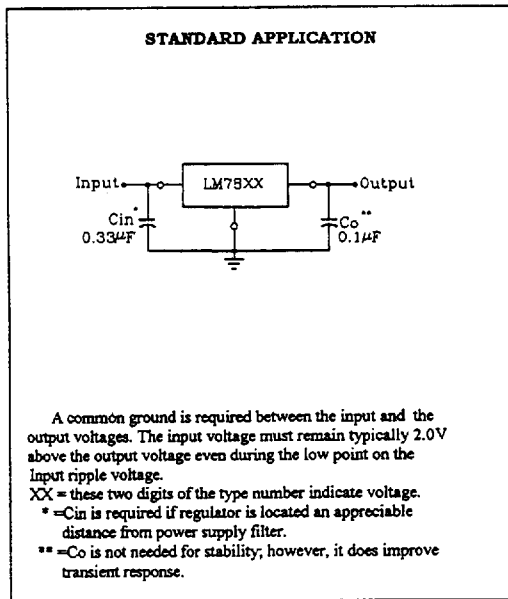



## LM7800 Series 3-Terminal Fixed Voltage Regulators

### ABSOLUTE MAXIMUM RATINGS (Ta=25°C)

Item	Symbol	LM7800 Series	Unit
Input Voltage	Vin *	30	V
Input Voltage	Vin **	40	V
Power Dissipation	P <sub>D</sub> ***	15	W
Operating Ambient Temperature	T <sub>opr</sub>	-20 to +75	°C
Operating Junction Temperature	T <sub>j</sub>	-20 to +125	°C
Storage Temperature	T <sub>stg</sub>	-55 to +125	°C

Note: \*LM7805 to LM7818

\*\* LM7824

\*\*\*Follow the derating curve

### LM7805 ELECTRICAL CHARACTERISTICS

(Vin=10V, I<sub>out</sub>=500mA, 0°C ≤ T<sub>j</sub> ≤ 125°C, C<sub>in</sub>=0.33μF, C<sub>out</sub>=0.1μF; unless otherwise specified.)

Item	Symbol	Test Conditions	min.	typ.	max.	unit	
Output Voltage	V <sub>out</sub>	T <sub>j</sub> =25°C	4.90	5.0	5.10	V	
		7V ≤ V <sub>in</sub> ≤ 20V, 5mA ≤ I <sub>out</sub> ≤ 1.0A, P <sub>D</sub> ≤ 15W	4.85	--	5.15	V	
Line Regulation	REG <sub>line</sub>	T <sub>j</sub> =25°C	7V ≤ V <sub>in</sub> ≤ 25V	--	3	100	mV
			8V ≤ V <sub>in</sub> ≤ 12V	--	1	50	mV
			5mA ≤ I <sub>out</sub> ≤ 1.5A	--	15	100	mV
Load Regulation	REG <sub>load</sub>	T <sub>j</sub> =25°C	250mA ≤ I <sub>out</sub> ≤ 750mA	--	5	50	mV
Quiescent Current	I <sub>q</sub>	T <sub>j</sub> =25°C, I <sub>out</sub> =0	--	4.2	8.0	mA	
Quiescent Current Change	Δ I <sub>q</sub>	7V ≤ V <sub>in</sub> ≤ 25V	--	--	1.3	mA	
		5mA ≤ I <sub>out</sub> ≤ 1.0A	--	--	0.5	mA	
Output Noise Voltage	V <sub>n</sub>	T <sub>a</sub> =25°C, 10Hz ≤ f ≤ 100KHz	--	40	--	μV	
Ripple Rejection Ratio	RR	f=120Hz	62	78	--	dB	
Voltage Drop	V <sub>drop</sub>	I <sub>out</sub> =1.0A, T <sub>j</sub> =25°C	--	2.0	--	V	
Output Resistance	R <sub>out</sub>	f=1KHz	--	17	--	mΩ	
Output Short Circuit Current	I <sub>os</sub>	T <sub>j</sub> =25°C	--	750	--	mA	
Peak Output Current	I <sub>o peak</sub>	T <sub>j</sub> =25°C	--	2.2	--	A	
Temperature Coefficient of Output Voltage	Δ V <sub>out</sub> /Δ T <sub>j</sub>	I <sub>out</sub> =5mA, 0°C ≤ T <sub>j</sub> ≤ 125°C	--	-1.1	--	mV/°C	



## LM7800 Series 3-Terminal Fixed Voltage Regulators

### LM7806 ELECTRICAL CHARACTERISTICS

( $V_{in}=11V$ ,  $I_{out}=500mA$ ,  $0^{\circ}C \leq T_j \leq 125^{\circ}C$ ,  $C_{in}=0.33\mu F$ ,  $C_{out}=0.1\mu F$ ; unless otherwise specified.)

Item	Symbol	Test Conditions	min.	typ.	max.	unit	
Output Voltage	Vout	$T_j=25^{\circ}C$	5.88	6.0	6.12	V	
		$8V \leq V_{in} \leq 21V$ , $5mA \leq I_{out} \leq 1.0A$ , $P_D \leq 15W$	5.83	--	6.17	V	
Line Regulation	$\Delta$ REGline	$T_j=25^{\circ}C$	$8V \leq V_{in} \leq 25V$	--	5	120	mV
			$9V \leq V_{in} \leq 13V$	--	1.5	60	mV
Load Regulation	$\Delta$ REGload	$T_j=25^{\circ}C$	$5mA \leq I_{out} \leq 1.5A$	--	14	120	mV
			$250mA \leq I_{out} \leq 750mA$	--	4.0	60	mV
Quiescent Current	Iq	$T_j=25^{\circ}C$ , $I_{out}=0$	--	4.3	8.0	mA	
Quiescent Current Change	$\Delta$ Iq	$8V \leq V_{in} \leq 25V$	--	--	1.3	mA	
		$5mA \leq I_{out} \leq 1.0A$	--	--	0.5	mA	
Output Noise Voltage	Vn	$T_a=25^{\circ}C$ , $10Hz \leq f \leq 100KHz$	--	45	--	$\mu V$	
Ripple Rejection Ratio	RR	$f=120Hz$	59	75	--	dB	
Voltage Drop	Vdrop	$I_{out}=1.0A$ , $T_j=25^{\circ}C$	--	2.0	--	V	
Output Resistance	Rout	$f=1KHz$	--	19	--	m $\Omega$	
Output Short Circuit Current	Ios	$T_j=25^{\circ}C$	--	550	--	mA	
Peak Output Current	I <sub>o peak</sub>	$T_j=25^{\circ}C$	--	2.2	--	A	
Temperature Coefficient of Output Voltage	$\Delta$ Vout/ $\Delta$ Tj	$I_{out}=5mA$ , $0^{\circ}C \leq T_j \leq 125^{\circ}C$	--	-0.8	--	mV/ $^{\circ}C$	

### LM7808 ELECTRICAL CHARACTERISTICS

( $V_{in}=14V$ ,  $I_{out}=500mA$ ,  $0^{\circ}C \leq T_j \leq 125^{\circ}C$ ,  $C_{in}=0.33\mu F$ ,  $C_{out}=0.1\mu F$ ; unless otherwise specified.)

Item	Symbol	Test Conditions	min.	typ.	max.	unit	
Output Voltage	Vout	$T_j=25^{\circ}C$	7.84	8.0	8.16	V	
		$10.5V \leq V_{in} \leq 23V$ , $5mA \leq I_{out} \leq 1.0A$ , $P_D \leq 15W$	7.74	--	8.26	V	
Line Regulation	$\Delta$ REGline	$T_j=25^{\circ}C$	$10.5V \leq V_{in} \leq 25V$	--	6	160	mV
			$11V \leq V_{in} \leq 17V$	--	2.0	80	mV
Load Regulation	$\Delta$ REGload	$T_j=25^{\circ}C$	$5mA \leq I_{out} \leq 1.5A$	--	12	160	mV
			$250mA \leq I_{out} \leq 750mA$	--	4	80	mV
Quiescent Current	Iq	$T_j=25^{\circ}C$ , $I_{out}=0$	--	4.3	8.0	mA	
Quiescent Current Change	$\Delta$ Iq	$10.5V \leq V_{in} \leq 25V$	--	--	1.0	mA	
		$5mA \leq I_{out} \leq 1.0A$	--	--	0.5	mA	
Output Noise Voltage	Vn	$T_a=25^{\circ}C$ , $10Hz \leq f \leq 100KHz$	--	52	--	$\mu V$	
Ripple Rejection Ratio	RR	$f=120Hz$	56	72	--	dB	
Voltage Drop	Vdrop	$I_{out}=1.0A$ , $T_j=25^{\circ}C$	--	2.0	--	V	
Output Resistance	Rout	$f=1KHz$	--	16	--	m $\Omega$	
Output Short Circuit Current	Ios	$T_j=25^{\circ}C$	--	450	--	mA	
Peak Output Current	I <sub>o peak</sub>	$T_j=25^{\circ}C$	--	2.2	--	A	
Temperature Coefficient of Output Voltage	$\Delta$ Vout/ $\Delta$ Tj	$I_{out}=5mA$ , $0^{\circ}C \leq T_j \leq 125^{\circ}C$	--	-1.8	--	mV/ $^{\circ}C$	



## LM7800 Series 3-Terminal Fixed Voltage Regulators

### LM7809 ELECTRICAL CHARACTERISTICS

( $V_{in}=15V$ ,  $I_{out}=500mA$ ,  $0^{\circ}C \leq T_j \leq 125^{\circ}C$ ,  $C_{in}=0.33\mu F$ ,  $C_{out}=0.1\mu F$ ; unless otherwise specified.)

Item	Symbol	Test Conditions	min.	typ.	max.	unit	
Output Voltage	$V_{out}$	$T_j=25^{\circ}C$	8.82	9	9.18	V	
		$10.5V \leq V_{in} \leq 27V$ , $5mA \leq I_{out} \leq 1.0A$ , $P_D \leq 15W$	8.77	--	9.23	V	
Line Regulation	$\Delta RE_{Gline}$	$T_j=25^{\circ}C$	$11.5V \leq V_{in} \leq 30V$	--	6	160	mV
			$12V \leq V_{in} \leq 18V$	--	2.0	80	mV
Load Regulation	$\Delta RE_{Gload}$	$T_j=25^{\circ}C$	$5mA \leq I_{out} \leq 1.5A$	--	12	160	mV
			$250mA \leq I_{out} \leq 750mA$	--	4	80	mV
Quiescent Current	$I_q$	$T_j=25^{\circ}C$ , $I_{out}=0$	--	4.3	1.0	mA	
Quiescent Current Change	$\Delta I_q$	$5mA \leq I_{out} \leq 1.0A$	$14.5V \leq V_{in} \leq 30V$	--	--	0.5	mA
			$5mA \leq I_{out} \leq 1.0A$	--	--	--	mA
Output Noise Voltage	$V_n$	$T_a=25^{\circ}C$ , $10Hz \leq f_s \leq 100KHz$	--	52	--	$\mu V$	
Ripple Rejection Ratio	RR	$f=120Hz$	55	72	--	dB	
Voltage Drop	$V_{drop}$	$I_{out}=1.0A$ , $T_j=25^{\circ}C$	--	2.0	--	V	
Output Resistance	$R_{out}$	$f=1KHz$	--	16	--	$m\Omega$	
Output Short Circuit Current	$I_{os}$	$T_j=25^{\circ}C$	--	450	--	mA	
Peak Output Current	$I_{o peak}$	$T_j=25^{\circ}C$	--	2.2	--	A	
Temperature Coefficient of Output Voltage	$\Delta V_{out}/\Delta T_j$	$I_{out}=5mA$ , $0^{\circ}C \leq T_j \leq 125^{\circ}C$	--	-1.8	--	$mV/^{\circ}C$	

### LM7810 ELECTRICAL CHARACTERISTICS

( $V_{in}=16V$ ,  $I_{out}=500mA$ ,  $0^{\circ}C \leq T_j \leq 125^{\circ}C$ ,  $C_{in}=0.33\mu F$ ,  $C_{out}=0.1\mu F$ ; unless otherwise specified.)

Item	Symbol	Test Conditions	min.	typ.	max.	unit	
Output Voltage	$V_{out}$	$T_j=25^{\circ}C$	9.8	10	10.2	V	
		$17.5V \leq V_{in} \leq 30V$ , $5mA \leq I_{out} \leq 1.0A$ , $P_D \leq 15W$	9.75	-	12.25	V	
Line Regulation	$\Delta RE_{Gline}$	$T_j=25^{\circ}C$	$10.5V \leq V_{in} \leq 30V$	--	10	240	mV
			$13V \leq V_{in} \leq 9V$	--	3.0	120	mV
Load Regulation	$\Delta RE_{Gload}$	$T_j=25^{\circ}C$	$5mA \leq I_{out} \leq 1.5A$	--	12	240	mV
			$250mA \leq I_{out} \leq 750mA$	--	4.0	120	mV
Quiescent Current	$I_q$	$T_j=25^{\circ}C$ , $I_{out}=0$	--	4.3	8.0	mA	
Quiescent Current Change	$\Delta I_q$	$5mA \leq I_{out} \leq 1.0A$	$14.5V \leq V_{in} \leq 30V$	--	--	1.0	mA
			$5mA \leq I_{out} \leq 1.0A$	--	--	0.5	mA
Output Noise Voltage	$V_n$	$T_a=25^{\circ}C$ , $10Hz \leq f_s \leq 100KHz$	--	52	--	$\mu V$	
Ripple Rejection Ratio	RR	$f=120Hz$	54	72	--	dB	
Voltage Drop	$V_{drop}$	$I_{out}=1.0A$ , $T_j=25^{\circ}C$	--	2.0	--	V	
Output Resistance	$R_{out}$	$f=1KHz$	--	16	--	$m\Omega$	
Output Short Circuit Current	$I_{os}$	$T_j=25^{\circ}C$	--	450	--	mA	
Peak Output Current	$I_{o peak}$	$T_j=25^{\circ}C$	--	2.2	--	A	
Temperature Coefficient of Output Voltage	$\Delta V_{out}/\Delta T_j$	$I_{out}=5mA$ , $0^{\circ}C \leq T_j \leq 125^{\circ}C$	--	-1.8	--	$mV/^{\circ}C$	



## LM7800 Series 3-Terminal Fixed Voltage Regulators

### LM7812 ELECTRICAL CHARACTERISTICS

( $V_{in}=19V$ ,  $I_{out}=500mA$ ,  $0^{\circ}C \leq T_j \leq 125^{\circ}C$ ,  $C_{in}=0.33\mu F$ ,  $C_{out}=0.1\mu F$ ; unless otherwise specified.)

Item	Symbol	Test Conditions	min.	typ.	max.	unit	
Output Voltage	Vout	$T_j=25^{\circ}C$	11.76	12.0	12.24	V	
		$14.5V \leq V_{in} \leq 27V$ , $5mA \leq I_{out} \leq 1.0A$ , $P_D \leq 15W$	11.66	--	12.34	V	
Line Regulation	$\Delta$ REGline	$T_j=25^{\circ}C$	$14.5V \leq V_{in} \leq 30V$	--	10	240	mV
			$16V \leq V_{in} \leq 22V$	--	3.0	120	mV
Load Regulation	$\Delta$ REGload	$T_j=25^{\circ}C$	$5mA \leq I_{out} \leq 1.5A$	--	12	240	mV
			$250mA \leq I_{out} \leq 750mA$	--	4.0	120	mV
Quiescent Current	Iq	$T_j=25^{\circ}C$ , $I_{out}=0$	--	4.3	8.0	mA	
Quiescent Current Change	$\Delta$ Iq	$T_j=25^{\circ}C$	$14.5V \leq V_{in} \leq 30V$	--	--	1.0	mA
			$5mA \leq I_{out} \leq 1.0A$	--	--	0.5	mA
Output Noise Voltage	Vn	$T_a=25^{\circ}C$ , $10Hz \leq f \leq 100KHz$	--	75	--	$\mu V$	
Ripple Rejection Ratio	RR	$f=120Hz$	55	71	--	dB	
Voltage Drop	Vdrop	$I_{out}=1.0A$ , $T_j=25^{\circ}C$	--	2.0	--	V	
Output Resistance	Rout	$f=1KHz$	--	18	--	m $\Omega$	
Output Short Circuit Current	Ios	$T_j=25^{\circ}C$	--	350	--	mA	
Peak Output Current	I <sub>o peak</sub>	$T_j=25^{\circ}C$	--	2.2	--	A	
Temperature Coefficient of Output Voltage	$\Delta$ Vout/ $\Delta$ Tj	$I_{out}=5mA$ , $0^{\circ}C \leq T_j \leq 125^{\circ}C$	--	-1.0	--	mV/ $^{\circ}C$	

### LM7815 ELECTRICAL CHARACTERISTICS

( $V_{in}=23V$ ,  $I_{out}=500mA$ ,  $0^{\circ}C \leq T_j \leq 125^{\circ}C$ ,  $C_{in}=0.33\mu F$ ,  $C_{out}=0.1\mu F$ ; unless otherwise specified.)

Item	Symbol	Test Conditions	min.	typ.	max.	unit	
Output Voltage	Vout	$T_j=25^{\circ}C$	14.7	15.0	15.3	V	
		$17.5V \leq V_{in} \leq 30V$ , $5mA \leq I_{out} \leq 1.0A$ , $P_D \leq 15W$	14.55	--	15.45	V	
Line Regulation	$\Delta$ REGline	$T_j=25^{\circ}C$	$17.5V \leq V_{in} \leq 30V$	--	11	300	mV
			$20V \leq V_{in} \leq 26V$	--	3.0	150	mV
Load Regulation	$\Delta$ REGload	$T_j=25^{\circ}C$	$5mA \leq I_{out} \leq 1.5A$	--	12	300	mV
			$250mA \leq I_{out} \leq 750mA$	--	4	150	mV
Quiescent Current	Iq	$T_j=25^{\circ}C$ , $I_{out}=0$	--	4.4	8.0	mA	
Quiescent Current Change	$\Delta$ Iq	$T_j=25^{\circ}C$	$17.5V \leq V_{in} \leq 30V$	--	--	1.0	mA
			$5mA \leq I_{out} \leq 1.0A$	--	--	0.5	mA
Output Noise Voltage	Vn	$T_a=25^{\circ}C$ , $10Hz \leq f \leq 100KHz$	--	90	--	$\mu V$	
Ripple Rejection Ratio	RR	$f=120Hz$	54	70	--	dB	
Voltage Drop	Vdrop	$I_{out}=1.0A$ , $T_j=25^{\circ}C$	--	2.0	--	V	
Output Resistance	Rout	$f=1KHz$	--	19	--	m $\Omega$	
Output Short Circuit Current	Ios	$T_j=25^{\circ}C$	--	230	--	mA	
Peak Output Current	I <sub>o peak</sub>	$T_j=25^{\circ}C$	--	2.1	--	A	
Temperature Coefficient of Output Voltage	$\Delta$ Vout/ $\Delta$ Tj	$I_{out}=5mA$ , $0^{\circ}C \leq T_j \leq 125^{\circ}C$	--	-1.0	--	mV/ $^{\circ}C$	



## LM7800 Series 3-Terminal Fixed Voltage Regulators

### LM7818 ELECTRICAL CHARACTERISTICS

( $V_{in}=27V$ ,  $I_{out}=500mA$ ,  $0^{\circ}C \leq T_j \leq 125^{\circ}C$ ,  $C_{in}=0.33\mu F$ ,  $C_{out}=0.1\mu F$ ; unless otherwise specified.)

Item	Symbol	Test Conditions	min.	typ.	max.	unit	
Output Voltage	$V_{out}$	$T_j=25^{\circ}C$	17.64	18.0	18.36	V	
		$21.0V \leq V_{in} \leq 33V$ , $5mA \leq I_{out} \leq 1.0A$ , $P_D \leq 15W$	17.44	--	18.56	V	
Line Regulation	$\Delta V_o$ line	$T_j=25^{\circ}C$	$21.0V \leq V_{in} \leq 33V$	--	15	360	mV
			$24V \leq V_{in} \leq 30V$	--	5.0	180	mV
Load Regulation	$\Delta REG_{load}$	$T_j=25^{\circ}C$	$5mA \leq I_{out} \leq 1.5A$	--	12	360	mV
			$250mA \leq I_{out} \leq 750mA$	--	4.0	180	mV
Quiescent Current	$I_q$	$T_j=25^{\circ}C$ , $I_{out}=0$		--	4.5	8.0	mA
			$21.0V \leq V_{in} \leq 33V$	--	--	1.0	mA
Quiescent Current Change	$\Delta I_q$	$5mA \leq I_{out} \leq 1.0A$	--	--	0.5	mA	
Output Noise Voltage	$V_n$	$T_a=25^{\circ}C$ , $10Hz \leq f \leq 100KHz$	--	110	--	$\mu V$	
Ripple Rejection Ratio	RR	$f=120Hz$	53	69	--	dB	
Voltage Drop	$V_{drop}$	$I_{out}=1.0A$ , $T_j=25^{\circ}C$	--	2.0	--	V	
Output Resistance	$R_{out}$	$f=1KHz$	--	22	--	$m\Omega$	
Output Short Circuit Current	$I_{os}$	$T_j=25^{\circ}C$	--	200	--	mA	
Peak Output Current	$I_{o peak}$	$T_j=25^{\circ}C$	--	2.1	--	A	
Temperature Coefficient of Output Voltage	$\Delta V_{out} / \Delta T_j$	$I_{out}=5mA$ , $0^{\circ}C \leq T_j \leq 125^{\circ}C$	--	-1.0	--	mV/ $^{\circ}C$	

### LM7824 ELECTRICAL CHARACTERISTICS

( $V_{in}=33V$ ,  $I_{out}=500mA$ ,  $0^{\circ}C \leq T_j \leq 125^{\circ}C$ ,  $C_{in}=0.33\mu F$ ,  $C_{out}=0.1\mu F$ ; unless otherwise specified.)

Item	Symbol	Test Conditions	min.	typ.	max.	unit	
Output Voltage	$V_{out}$	$T_j=25^{\circ}C$	23.52	24.0	24.48	V	
		$27.0V \leq V_{in} \leq 38V$ , $5mA \leq I_{out} \leq 1.0A$ , $P_D \leq 15W$	23.32	--	24.68	V	
Line Regulation	$\Delta V_o$ line	$T_j=25^{\circ}C$	$27.0V \leq V_{in} \leq 38V$	--	18	480	mV
			$30V \leq V_{in} \leq 36V$	--	6.0	240	mV
Load Regulation	$\Delta V_o$ load	$T_j=25^{\circ}C$	$5mA \leq I_{out} \leq 1.5A$	--	12	480	mV
			$250mA \leq I_{out} \leq 750mA$	--	4.0	240	mV
Quiescent Current	$I_q$	$T_j=25^{\circ}C$ , $I_{out}=0$		--	4.6	8.0	mA
			$27.0V \leq V_{in} \leq 38V$	--	--	1.0	mA
Quiescent Current Change	$\Delta I_q$	$5mA \leq I_{out} \leq 1.0A$	--	--	0.5	mA	
Output Noise Voltage	$V_n$	$T_a=25^{\circ}C$ , $10Hz \leq f \leq 100KHz$	--	170	--	$\mu V$	
Ripple Rejection Ratio	RR	$f=120Hz$	50	66	--	dB	
Voltage Drop	$V_{drop}$	$I_{out}=1.0A$ , $T_j=25^{\circ}C$	--	2.0	--	V	
Output Resistance	$R_{out}$	$f=1KHz$	--	28	--	$m\Omega$	
Output Short Circuit Current	$I_{os}$	$T_j=25^{\circ}C$	--	150	--	mA	
Peak Output Current	$I_{o peak}$	$T_j=25^{\circ}C$	--	2.1	--	A	
Temperature Coefficient of Output Voltage	$\Delta V_{out} / \Delta T_j$	$I_{out}=5mA$ , $0^{\circ}C \leq T_j \leq 125^{\circ}C$	--	-1.5	--	mV/ $^{\circ}C$	



# LM7800 Series 3-Terminal Fixed Voltage Regulators

**FIGURE 1 - WORST CASE POWER DISSIPATION versus AMBIENT TEMPERATURE (Case 221A)**

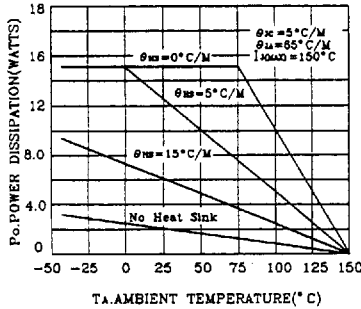

**FIGURE 2 - WORST CASE POWER DISSIPATION versus AMBIENT TEMPERATURE (Case 1)**

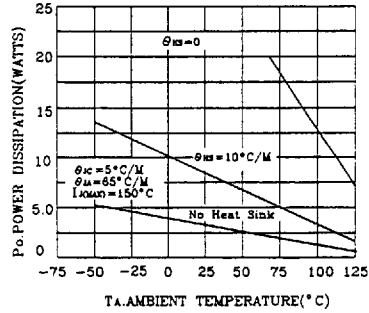

**FIGURE 3 - INPUT OUTPUT DIFFERENTIAL AS A FUNCTION OF JUNCTION TEMPERATURE**

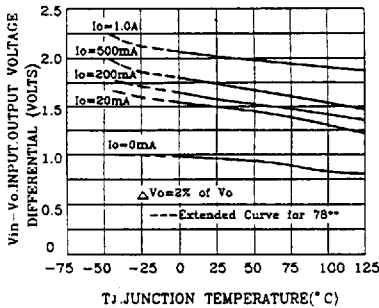

**FIGURE 4 - INPUT OUTPUT DIFFERENTIAL AS A FUNCTION OF JUNCTION TEMPERATURE**

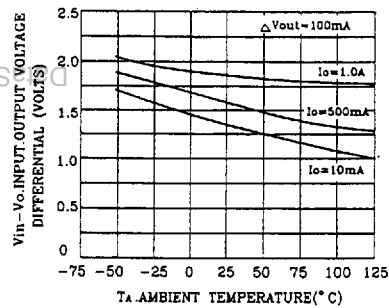

**FIGURE 5 - PEAK OUTPUT CURRENT AS A FUNCTION OF INPUT-OUTPUT DIFFERENTIAL VOLTAGE**

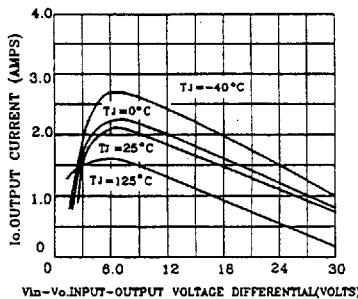

**FIGURE 6 - PEAK OUTPUT CURRENT AS A FUNCTION OF INPUT-OUTPUT DIFFERENTIAL VOLTAGE**

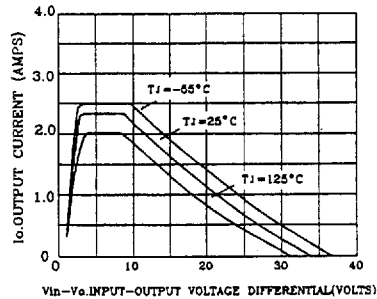



# LM7800 Series 3-Terminal Fixed Voltage Regulators

**FIGURE 7 - RIPPLE REJECTION AS A FUNCTION OF OUTPUT VOLTAGE**

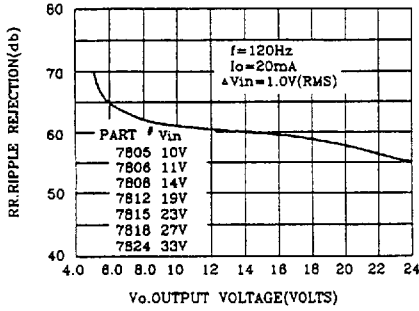

**FIGURE 8 - RIPPLE REJECTION AS A FUNCTION OF FREQUENCY**

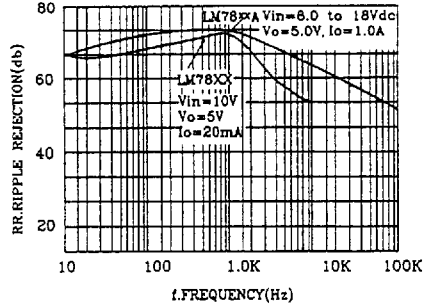

**FIGURE 9 - OUTPUT VOLTAGE AS A FUNCTION OF JUNCTION TEMPERATURE**

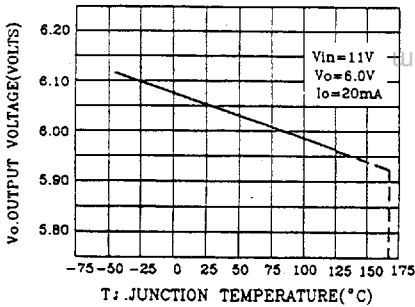

**FIGURE 10 - OUTPUT IMPEDANCE AS A FUNCTION OF OUTPUT VOLTAGE**

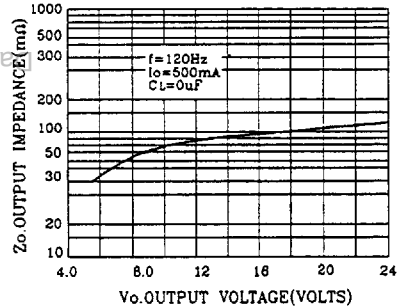

**FIGURE 11 - QUIESCENT CURRENT AS A FUNCTION OF TEMPERATURE**

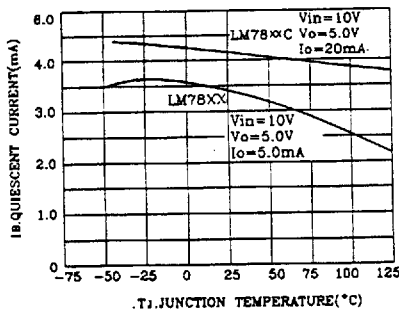

**FIGURE 12 - DROPOUT CHARACTERISTICS**

