

Low Current Negative Voltage Regulator

LM79LXXM3

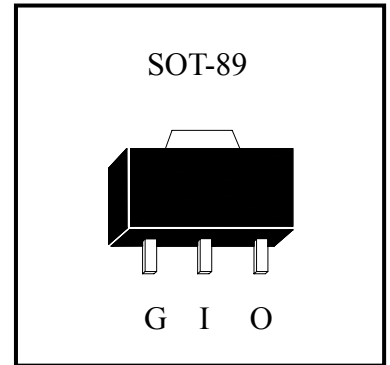

Description

The LM79LXXM3 series of negative regulators are available in the SOT-89 package and with -5V, -6V, -8V, -9V, -12V, -15V, -18V and -24V fixed output voltages, making it useful in a wide range of applications. These regulators can provide local on-card regulation, eliminating the distribution problems associated with single point regulation. Each type employs internal current limiting, thermal shut-down and safe operating area protection, making it essentially indestructible. If adequate heat sinking is provided, they can deliver over 100mA output current. Although designed primarily as fixed voltage regulators, these devices can be used with external components to obtain adjustable voltages and currents. LM79LXXM3 is characterized for operation from 0°C to 125°C.

Features:

- Internal Short-Circuit Current Limiting
- Internal Thermal Overload Protection
- No External Components Required
- Pb-free lead plating package

Typical Application

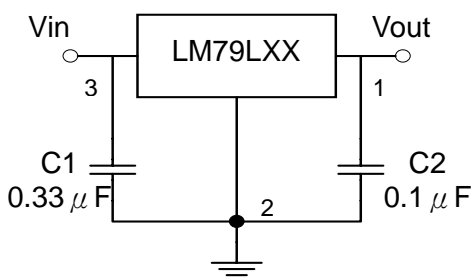

A common ground is required between the input and the output voltages. The input voltage must remain typically 2.0V above the output voltage even during the low point on the input ripple voltage.

Note : C1 and C2 are required if regulator is located far from power supply filter and load, or oscillation may be induced on the loop.

Representative Schematic Diagram

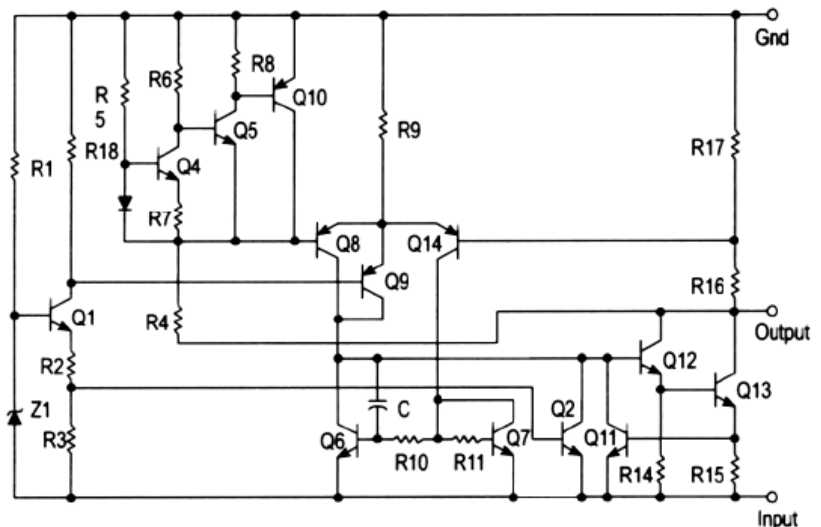



Absolute Maximum Ratings

| Parameter | Ratings | Unit |
|--------------------------------------|--------------|------|
| Input Voltage | LM79L05 ~ 09 | -30 |
| | LM79L12 ~18 | -35 |
| | LM79L24 | -40 |
| Output Current | 100 | mA |
| Operating Junction Temperature Range | 0 ~ 125 | °C |
| Storage Temperature Range | -65 ~ 150 | °C |
| Power Dissipation | 350 (Note) | mW |

Note : When tested in free air condition, without heat sinking.

Electrical Characteristics

LM79L05 ($V_{in}=-10V$, $I_o=40mA$, $T_j=0\sim 125^{\circ}C$, $C_{in}=0.33\mu F$, $C_{out}=0.1\mu F$, unless otherwise noted) (Note 1)

| Symbol | Parameter | Min | Typ | Max | Conditions | Units |
|----------------------------------|--------------------------|-------|-----|-------|--|---------|
| Vo | Output Voltage | -4.85 | -5 | -5.15 | $V_{in}=-10V$, $I_o=40mA$, $T_j=25^{\circ}C$ $-7V \leq V_{in} \leq -20V$, $1mA \leq I_o \leq 40mA$ | V |
| | | -4.75 | - | -5.25 | $V_{in}=-10V$, $1mA \leq I_o \leq 70mA$ (Note 2) | |
| ΔV_o | Line Regulation | - | 15 | 150 | $-7V \leq V_{in} \leq -20V$, $T_j=25^{\circ}C$ | mV |
| ΔV_o | Load Regulation | - | 20 | 60 | $1mA \leq I_o \leq 100mA$, $T_j=25^{\circ}C$ | mV |
| IQ | Quiescent Current | - | - | 6 | $V_{in}=-10V$, $I_o=40mA$, $T_j=25^{\circ}C$ | mA |
| ΔIQ | Quiescent Current Change | - | - | 1.5 | $-8V \leq V_{in} \leq -20V$ | mA |
| | | - | - | 0.1 | $1mA \leq I_o \leq 40mA$ | |
| Vn | Output Noise Voltage | - | 40 | - | $10Hz \leq f \leq 100KHz$ | μV |
| $\Delta V_{in} / \Delta V_{out}$ | Ripple Rejection | 41 | 49 | - | $-8V \leq V_{in} \leq -18V$, $f=120Hz$, $T_j=25^{\circ}C$ | dB |
| VD | Dropout Voltage | - | 1.7 | - | $I_o=100mA$, $T_j=25^{\circ}C$ | V |

LM79L06 ($V_{in}=-11V$, $I_o=40mA$, $T_j=0\sim 125^{\circ}C$, $C_{in}=0.33\mu F$, $C_{out}=0.1\mu F$, unless otherwise noted) (Note 1)

| Symbol | Parameter | Min | Typ | Max | Conditions | Units |
|----------------------------------|--------------------------|-------|-----|-------|--|---------|
| Vo | Output Voltage | -5.82 | -6 | -6.18 | $V_{in}=-11V$, $I_o=40mA$, $T_j=25^{\circ}C$ $-8V \leq V_{in} \leq -20V$, $1mA \leq I_o \leq 40mA$ | V |
| | | -5.70 | - | -6.30 | $V_{in}=-11V$, $1mA \leq I_o \leq 70mA$ (Note 2) | |
| ΔV_o | Line Regulation | - | 20 | 150 | $-8V \leq V_{in} \leq -20V$, $T_j=25^{\circ}C$ | mV |
| ΔV_o | Load Regulation | - | 21 | 60 | $V_{in}=-11V$, $1mA \leq I_o \leq 100mA$, $T_j=25^{\circ}C$ | mV |
| IQ | Quiescent Current | - | - | 6 | $V_{in}=-11V$, $I_o=40mA$, $T_j=25^{\circ}C$ | mA |
| ΔIQ | Quiescent Current Change | - | - | 1.5 | $-9V \leq V_{in} \leq -20V$ | mA |
| | | - | - | 0.1 | $1mA \leq I_o \leq 40mA$ | |
| Vn | Output Noise Voltage | - | 44 | - | $10Hz \leq f \leq 100KHz$ | μV |
| $\Delta V_{in} / \Delta V_{out}$ | Ripple Rejection | 40 | 48 | - | $-9V \leq V_{in} \leq -19V$, $f=120Hz$, $T_j=25^{\circ}C$ | dB |
| VD | Dropout Voltage | - | 1.7 | - | $I_o=100mA$, $T_j=25^{\circ}C$ | V |



LM79L08 ($V_{in}=-14V$, $I_o=40mA$, $T_j=0\sim 125^{\circ}C$, $C_{in}=0.33\mu F$, $C_{out}=0.1\mu F$, unless otherwise noted) (Note 1)

| Symbol | Parameter | Min | Typ | Max | Conditions | Units | |
|----------------------------------|--------------------------|----------------|-------|-----|--|--|---|
| Vo | A-rank(3%) | Output Voltage | -7.76 | -8 | -8.24 | $V_{in}=-14V$, $I_o=40mA$, $T_j=25^{\circ}C$ $-10.5V \leq V_{in} \leq -23V$, $1mA \leq I_o \leq 40mA$ $V_{in}=-14V$, $1mA \leq I_o \leq 70mA$ (Note 2) | V |
| | B-rank(5%) | | -7.60 | - | -8.40 | | |
| ΔV_o | Line Regulation | - | 42 | 175 | $-10.5V \leq V_{in} \leq -23V$, $T_j=25^{\circ}C$ | mV | |
| ΔV_o | Load Regulation | - | 30 | 80 | $1mA \leq I_o \leq 100mA$, $T_j=25^{\circ}C$ | mV | |
| IQ | Quiescent Current | - | - | 6 | $V_{in}=-14V$, $I_o=40mA$, $T_j=25^{\circ}C$ | mA | |
| ΔIQ | Quiescent Current Change | - | - | 1.5 | $-11V \leq V_{in} \leq -23V$ | mA | |
| | | - | - | 0.1 | $1mA \leq I_o \leq 40mA$ | | |
| Vn | Output Noise Voltage | - | 54 | - | $10Hz \leq f \leq 100KHz$ | μV | |
| $\Delta V_{in} / \Delta V_{out}$ | Ripple Rejection | 37 | 46 | - | $-11V \leq V_{in} \leq -21V$, $f=120Hz$, $T_j=25^{\circ}C$ | dB | |
| VD | Dropout Voltage | - | 1.7 | - | $I_o=100mA$, $T_j=25^{\circ}C$ | V | |

LM79L09 ($V_{in}=-15V$, $I_o=40mA$, $T_j=0\sim 125^{\circ}C$, $C_{in}=0.33\mu F$, $C_{out}=0.1\mu F$, unless otherwise noted) (Note 1)

| Symbol | Parameter | Min | Typ | Max | Conditions | Units | |
|----------------------------------|--------------------------|----------------|-------|-----|--|--|---|
| Vo | A-rank(3%) | Output Voltage | -8.73 | -9 | -9.27 | $V_{in}=-15V$, $I_o=40mA$, $T_j=25^{\circ}C$ $-11.5V \leq V_{in} \leq -24V$, $1mA \leq I_o \leq 40mA$ $V_{in}=-15V$, $1mA \leq I_o \leq 70mA$ (Note 2) | V |
| | B-rank(5%) | | -8.55 | - | -9.45 | | |
| ΔV_o | Line Regulation | - | 42 | 200 | $-11.5V \leq V_{in} \leq -24V$, $T_j=25^{\circ}C$ | mV | |
| ΔV_o | Load Regulation | - | 30 | 90 | $1mA \leq I_o \leq 100mA$, $T_j=25^{\circ}C$ | mV | |
| IQ | Quiescent Current | - | - | 6.0 | $V_{in}=-15V$, $I_o=40mA$, $T_j=25^{\circ}C$ | mA | |
| ΔIQ | Quiescent Current Change | - | - | 1.5 | $-12V \leq V_{in} \leq -24V$ | mA | |
| | | - | - | 0.1 | $1mA \leq I_o \leq 40mA$ | | |
| Vn | Output Noise Voltage | - | 54 | - | $10Hz \leq f \leq 100KHz$ | μV | |
| $\Delta V_{in} / \Delta V_{out}$ | Ripple Rejection | 37 | 46 | - | $-12V \leq V_{in} \leq -22V$, $f=120Hz$, $T_j=25^{\circ}C$ | dB | |
| VD | Dropout Voltage | - | 1.7 | - | $I_o=100mA$, $T_j=25^{\circ}C$ | V | |

LM79L12 ($V_{in}=-19V$, $I_o=40mA$, $T_j=0\sim 125^{\circ}C$, $C_{in}=0.33\mu F$, $C_{out}=0.1\mu F$, unless otherwise noted) (Note 1)

| Symbol | Parameter | Min | Typ | Max | Conditions | Units | |
|----------------------------------|--------------------------|----------------|--------|-----|--|--|---|
| Vo | A-rank(3%) | Output Voltage | -11.64 | -12 | -12.36 | $V_{in}=-19V$, $I_o=40mA$, $T_j=25^{\circ}C$ $-14.5V \leq V_{in} \leq -27V$, $1mA \leq I_o \leq 40mA$ $V_{in}=-19V$, $1mA \leq I_o \leq 70mA$ (Note 2) | V |
| | B-rank(5%) | | -11.40 | - | -12.60 | | |
| ΔV_o | Line Regulation | - | 50 | 250 | $-14.5V \leq V_{in} \leq -27V$, $T_j=25^{\circ}C$ | mV | |
| ΔV_o | Load Regulation | - | 24 | 100 | $1mA \leq I_o \leq 100mA$, $T_j=25^{\circ}C$ | mV | |
| IQ | Quiescent Current | - | - | 6.5 | $V_{in}=-19V$, $I_o=40mA$, $T_j=25^{\circ}C$ | mA | |
| ΔIQ | Quiescent Current Change | - | - | 1.5 | $-16V \leq V_{in} \leq -27V$ | mA | |
| | | - | - | 0.1 | $1mA \leq I_o \leq 40mA$ | | |
| Vn | Output Noise Voltage | - | 80 | - | $10Hz \leq f \leq 100KHz$ | μV | |
| $\Delta V_{in} / \Delta V_{out}$ | Ripple Rejection | 37 | 42 | - | $-15V \leq V_{in} \leq -25V$, $f=120Hz$, $T_j=25^{\circ}C$ | dB | |
| VD | Dropout Voltage | - | 1.7 | - | $I_o=100mA$, $T_j=25^{\circ}C$ | V | |



LM79L15 ($V_{in}=-23V$, $I_o=40mA$, $T_j=0\sim 125^{\circ}C$, $C_{in}=0.33\mu F$, $C_{out}=0.1\mu F$, unless otherwise noted) (Note 1)

| Symbol | Parameter | Min | Typ | Max | Conditions | Units | |
|----------------------------------|--------------------------|----------------|--------|-----|--|--|---|
| Vo | A-rank(3%) | Output Voltage | -14.55 | -15 | -15.45 | $V_{in}=-23V$, $I_o=40mA$, $T_j=25^{\circ}C$ $-17.5V \leq V_{in} \leq -30V$, $1mA \leq I_o \leq 40mA$ $V_{in}=-23V$, $1mA \leq I_o \leq 70mA$ (Note 2) | V |
| | B-rank(5%) | | -14.25 | - | -15.75 | | |
| ΔV_o | Line Regulation | - | 65 | 300 | $-17.5V \leq V_{in} \leq -30V$, $T_j=25^{\circ}C$ | mV | |
| ΔV_o | Load Regulation | - | 25 | 150 | $1mA \leq I_o \leq 100mA$, $T_j=25^{\circ}C$ | mV | |
| IQ | Quiescent Current | - | - | 6.5 | $V_{in}=-23V$, $I_o=40mA$, $T_j=25^{\circ}C$ | mA | |
| ΔI_Q | Quiescent Current Change | - | - | 1.5 | $-20V \leq V_{in} \leq -30V$ | mA | |
| | | - | - | 0.1 | $1mA \leq I_o \leq 40mA$ | | |
| Vn | Output Noise Voltage | - | 90 | - | $10Hz \leq f \leq 100KHz$ | μV | |
| $\Delta V_{in} / \Delta V_{out}$ | Ripple Rejection | 34 | 39 | - | $-18.5V \leq V_{in} \leq -28.5V$, $f=120Hz$, $T_j=25^{\circ}C$ | dB | |
| V _D | Dropout Voltage | - | 1.7 | - | $I_o=100mA$, $T_j=25^{\circ}C$ | V | |

LM79L18 ($V_{in}=-27V$, $I_o=40mA$, $T_j=0\sim 125^{\circ}C$, $C_{in}=0.33\mu F$, $C_{out}=0.1\mu F$, unless otherwise noted) (Note 1)

| Symbol | Parameter | Min | Typ | Max | Conditions | Units | |
|----------------------------------|--------------------------|----------------|--------|-----|--|--|---|
| Vo | A-rank(3%) | Output Voltage | -17.46 | -18 | -18.54 | $V_{in}=-27V$, $I_o=40mA$, $T_j=25^{\circ}C$ $-20.5V \leq V_{in} \leq -33V$, $1mA \leq I_o \leq 40mA$ $V_{in}=-27V$, $1mA \leq I_o \leq 70mA$ (Note 2) | V |
| | B-rank(5%) | | -17.10 | - | -18.90 | | |
| ΔV_o | Line Regulation | - | 70 | 300 | $-20.5V \leq V_{in} \leq -33V$, $T_j=25^{\circ}C$ | mV | |
| ΔV_o | Load Regulation | - | 27 | 170 | $1mA \leq I_o \leq 100mA$, $T_j=25^{\circ}C$ | mV | |
| IQ | Quiescent Current | - | - | 6.5 | $V_{in}=-27V$, $I_o=40mA$, $T_j=25^{\circ}C$ | mA | |
| ΔI_Q | Quiescent Current Change | - | - | 1.5 | $-21V \leq V_{in} \leq -33V$ | mA | |
| | | - | - | 0.1 | $1mA \leq I_o \leq 40mA$ | | |
| Vn | Output Noise Voltage | - | 150 | - | $10Hz \leq f \leq 100KHz$ | μV | |
| $\Delta V_{in} / \Delta V_{out}$ | Ripple Rejection | 33 | 48 | - | $-23V \leq V_{in} \leq -33V$, $f=120Hz$, $T_j=25^{\circ}C$ | dB | |
| V _D | Dropout Voltage | - | 1.7 | - | $I_o=100mA$, $T_j=25^{\circ}C$ | V | |

LM79L24 ($V_{in}=-33V$, $I_o=40mA$, $T_j=0\sim 125^{\circ}C$, $C_{in}=0.33\mu F$, $C_{out}=0.1\mu F$, unless otherwise noted) (Note 1)

| Symbol | Parameter | Min | Typ | Max | Conditions | Units | |
|----------------------------------|--------------------------|----------------|--------|-----|--|--|---|
| Vo | A-rank(3%) | Output Voltage | -23.28 | -24 | -24.72 | $V_{in}=-33V$, $I_o=40mA$, $T_j=25^{\circ}C$ $-27V \leq V_{in} \leq -38V$, $1mA \leq I_o \leq 40mA$ $V_{in}=-33V$, $1mA \leq I_o \leq 70mA$ (Note 2) | V |
| | B-rank(5%) | | -22.80 | - | -25.20 | | |
| ΔV_o | Line Regulation | - | 90 | 350 | $-27V \leq V_{in} \leq -38V$, $T_j=25^{\circ}C$ | mV | |
| ΔV_o | Load Regulation | - | 40 | 200 | $1mA \leq I_o \leq 100mA$, $T_j=25^{\circ}C$ | mV | |
| IQ | Quiescent Current | - | - | 6.5 | $V_{in}=-33V$, $I_o=40mA$, $T_j=25^{\circ}C$ | mA | |
| ΔI_Q | Quiescent Current Change | - | - | 1.5 | $-28V \leq V_{in} \leq -38V$ | mA | |
| | | - | - | 0.1 | $1mA \leq I_o \leq 40mA$ | | |
| Vn | Output Noise Voltage | - | 200 | - | $10Hz \leq f \leq 100KHz$ | μV | |
| $\Delta V_{in} / \Delta V_{out}$ | Ripple Rejection | 31 | 47 | - | $-29V \leq V_{in} \leq -35V$, $f=120Hz$, $T_j=25^{\circ}C$ | dB | |
| V _D | Dropout Voltage | - | 1.7 | - | $I_o=100mA$, $T_j=25^{\circ}C$ | V | |

Note : 1. The maximum steady state usable output current is dependent on input voltage, heat sinking, lead length of the package and copper of PCB. The data above represent pulse test conditions with junction temperatures specified at the initial of test.

2. Power dissipation < 0.5W



Ordering Information

| Device | Output Voltage Tolerance | Package | Shipping | Marking |
|------------------|--------------------------|---------------------|------------------------|---------|
| LM79LXXM3 A-rank | ±3% | SOT-89 (Pb-free) | 1000 pcs / Tape & Reel | 79LXX |
| LM79LXXM3 B-rank | ±5% | SOT-89 (Pb-free) | 1000 pcs / Tape & Reel | 79LXX |

Typical Characteristics

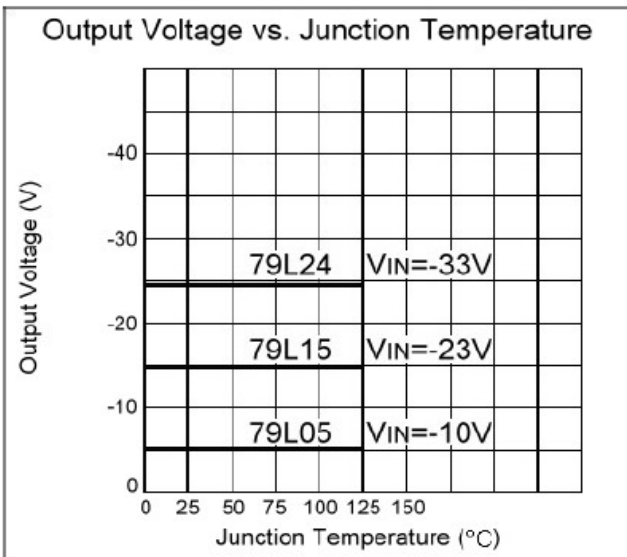
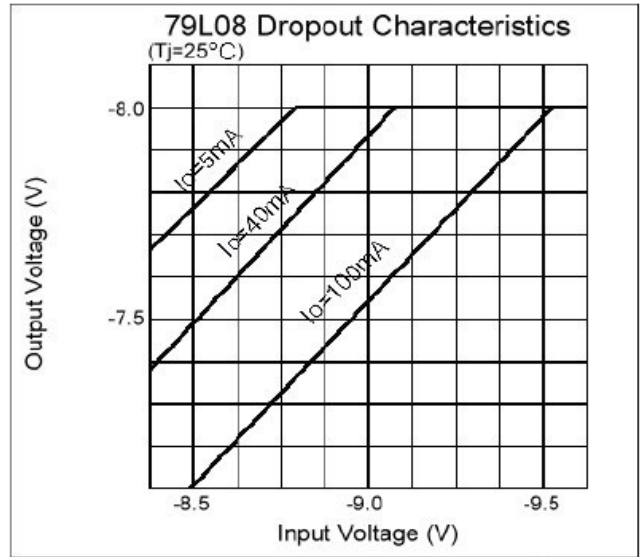
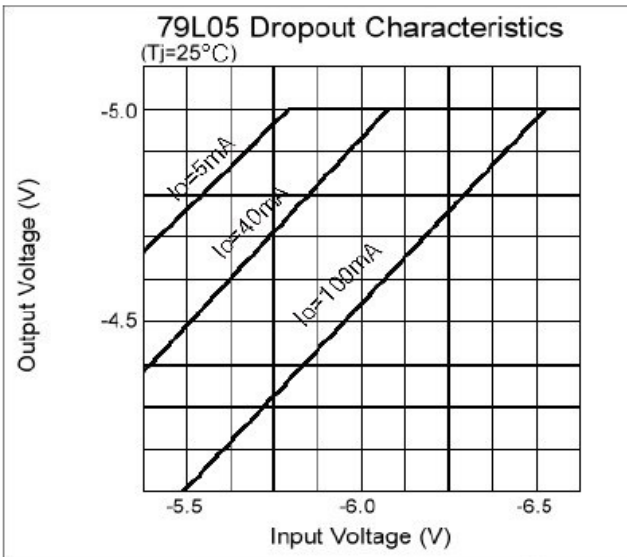
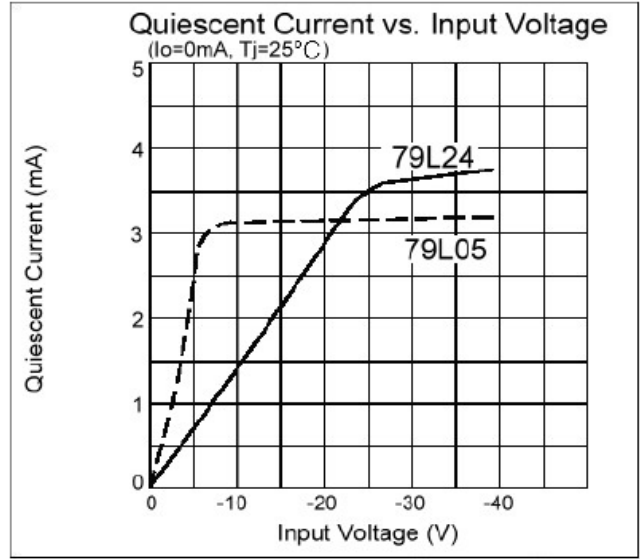
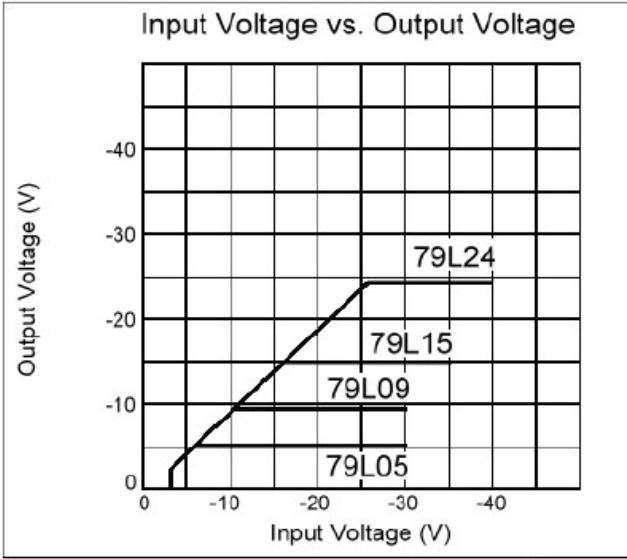

SOT-89 Dimension

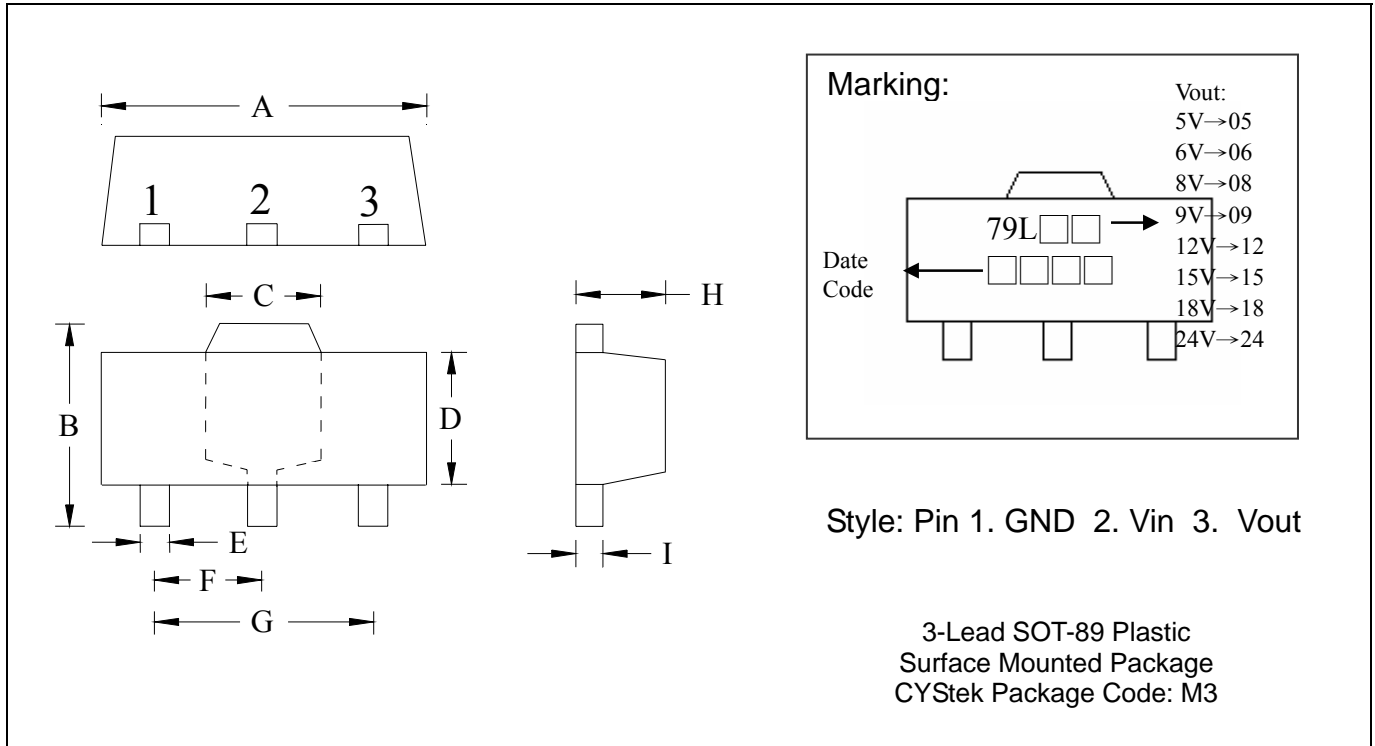

*: Typical

| DIM | Inches | | Millimeters | | DIM | Inches | | Millimeters | |
|-----|--------|--------|-------------|------|-----|--------|--------|-------------|------|
| | Min. | Max. | Min. | Max. | | Min. | Max. | Min. | Max. |
| A | 0.1732 | 0.1811 | 4.40 | 4.60 | F | 0.0591 | TYP | 1.50 | TYP |
| B | 0.1551 | 0.1673 | 3.94 | 4.25 | G | 0.1181 | TYP | 3.00 | TYP |
| C | 0.0610 | REF | 1.55 | REF | H | 0.0551 | 0.0630 | 1.40 | 1.60 |
| D | 0.0906 | 0.1024 | 2.30 | 2.60 | I | 0.0138 | 0.0173 | 0.35 | 0.44 |
| E | 0.0126 | 0.0205 | 0.32 | 0.52 | | | | | |

Notes: 1.Controlling dimension: millimeters.
 2.Maximum lead thickness includes lead finish thickness, and minimum lead thickness is the minimum thickness of base material.
 3.If there is any question with packing specification or packing method, please contact your local CYStek sales office.

Material:

- Lead: Pure tin plated.
- Mold Compound: Epoxy resin family, flammability solid burning class: UL94V-0

Important Notice:

- All rights are reserved. Reproduction in whole or in part is prohibited without the prior written approval of CYStek.
- CYStek reserves the right to make changes to its products without notice.
- CYStek **semiconductor products are not warranted to be suitable for use in Life-Support Applications, or systems.**
- CYStek assumes no liability for any consequence of customer product design, infringement of patents, or application assistance.