

LM833 Dual High-Speed Audio Operational Amplifier

1 Features

- Dual-Supply Operation: ± 5 V to ± 18 V
- Low Noise Voltage: $4.5 \text{ nV}/\sqrt{\text{Hz}}$
- Low Input Offset Voltage: 0.15 mV
- Low Total Harmonic Distortion: 0.002%
- High Slew Rate: $7 \text{ V}/\mu\text{s}$
- High-Gain Bandwidth Product: 16 MHz
- High Open-Loop AC Gain: 800 at 20 kHz
- Large Output-Voltage Swing: -14.6 V to 14.1 V
- Excellent Gain and Phase Margins
- Available in 8-Terminal MSOP Package (3.0 mm x 4.9 mm x 0.65 mm)

2 Applications

- HiFi Audio System Equipment
- Pre-amplification and Filtering
- Set-Top Box
- Microphone Pre-amplifier Circuit
- General-Purpose Amplifier Applications

4 Typical Design Example Audio Pre-Amplifier

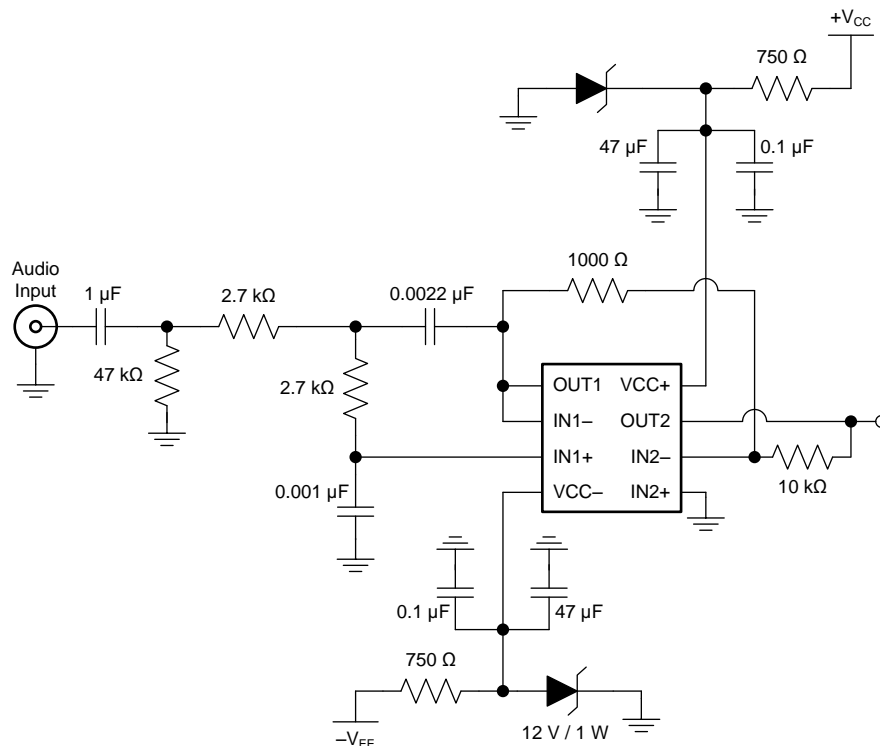

3 Description

The LM833 device is a dual operational amplifier with high-performance specifications for use in quality audio and data-signal applications. Dual amplifiers are utilized widely in audio circuits optimized for all preamp and high level stages in PCM and HiFi systems. The LM833 device is pin-for-pin compatible with industry-standard dual operation amplifiers. With addition of a preamplifier, the gain of the power stage can be greatly reduced to improve performance.

Device Information

| PART NUMBER | PACKAGE | BODY SIZE (NOM) |
|-------------|-----------|-------------------|
| LM833 | SOIC (8) | 4.90 mm x 3.91 mm |
| | VSSOP (8) | 3.00 mm x 3.00 mm |
| | PDIP (8) | 9.81 mm x 6.35 mm |



Table of Contents

| | |
|---|---|
| <p>1 Features 1</p> <p>2 Applications 1</p> <p>3 Description 1</p> <p>4 Typical Design Example Audio Pre-Amplifier 1</p> <p>5 Revision History 2</p> <p>6 Pin Configuration and Functions 3</p> <p>7 Specifications 4</p> <p style="padding-left: 20px;">7.1 Absolute Maximum Ratings 4</p> <p style="padding-left: 20px;">7.2 Handling Ratings 4</p> <p style="padding-left: 20px;">7.3 Recommended Operating Conditions 4</p> <p style="padding-left: 20px;">7.4 Thermal Information 4</p> <p style="padding-left: 20px;">7.5 Electrical Characteristics 5</p> <p style="padding-left: 20px;">7.6 Operating Characteristics 5</p> <p style="padding-left: 20px;">7.7 Typical Characteristics 6</p> <p>8 Detailed Description 13</p> <p style="padding-left: 20px;">8.1 Overview 13</p> <p style="padding-left: 20px;">8.2 Functional Block Diagram 13</p> | <p style="padding-left: 20px;">8.3 Feature Description 14</p> <p style="padding-left: 20px;">8.4 Device Functional Modes 14</p> <p>9 Application and Implementation 15</p> <p style="padding-left: 20px;">9.1 Application Information 15</p> <p style="padding-left: 20px;">9.2 Typical Application 15</p> <p style="padding-left: 20px;">9.3 Typical Application — Reducing Oscillation from High-Capacitive Loads 18</p> <p>10 Power Supply Recommendations 20</p> <p>11 Layout 20</p> <p style="padding-left: 20px;">11.1 Layout Guidelines 20</p> <p style="padding-left: 20px;">11.2 Layout Example 20</p> <p>12 Device and Documentation Support 22</p> <p style="padding-left: 20px;">12.1 Trademarks 22</p> <p style="padding-left: 20px;">12.2 Electrostatic Discharge Caution 22</p> <p style="padding-left: 20px;">12.3 Glossary 22</p> <p>13 Mechanical, Packaging, and Orderable Information 23</p> |
|---|---|

5 Revision History

Changes from Revision A (August 2010) to Revision B

Page

| | |
|--|---|
| <ul style="list-style-type: none"> • Updated document to new TI data sheet format 1 • Deleted <i>Ordering Information</i> table. 1 • Added <i>Device Information</i> table. 1 • Added <i>Pin Functions</i> table. 3 • Added <i>Handling Ratings</i> table. 4 • Added <i>Thermal Information</i> table. 4 • Added <i>Power Supply Recommendations, Layout, Device and Documentation Support, and Mechanical, Packaging, and Orderable Information</i> sections 20 | <p>1</p> <p>1</p> <p>1</p> <p>3</p> <p>4</p> <p>4</p> <p>20</p> |
|--|---|

Changes from Original (July 2010) to Revision A

Page

| | |
|---|----------|
| <ul style="list-style-type: none"> • Changed data sheet status from Product Preview to Production Data. 1 | <p>1</p> |
|---|----------|

6 Pin Configuration and Functions

D (SOIC), DGK (MSOP), OR P (PDIP) PACKAGE
(TOP VIEW)

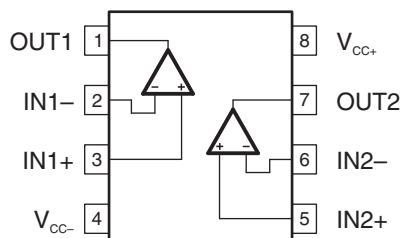

Pin Functions

| PIN | | TYPE | DESCRIPTION |
|------------------|-----|--------|--------------------|
| NAME | NO. | | |
| IN1+ | 3 | Input | Noninverting input |
| IN1- | 2 | Input | Inverting Input |
| IN2+ | 5 | Input | Noninverting input |
| IN2- | 6 | Input | Inverting Input |
| OUT1 | 1 | Output | Output 1 |
| OUT2 | 7 | Output | Output 2 |
| V _{CC+} | 8 | — | Positive Supply |
| V _{CC-} | 4 | — | Negative Supply |

7 Specifications

7.1 Absolute Maximum Ratings

over operating free-air temperature range (unless otherwise noted)⁽¹⁾

| | | MIN | MAX | UNIT |
|-------------------------------------|---|------------------|------------------|------|
| V _{CC+} | Supply voltage ⁽²⁾ | | 18 | V |
| V _{CC-} | Supply voltage ⁽²⁾ | | -18 | V |
| V _{CC+} – V _{CC-} | Supply voltage | | 36 | V |
| | Input voltage, either input ⁽²⁾⁽³⁾ | V _{CC-} | V _{CC+} | V |
| | Input current ⁽⁴⁾ | | ±10 | mA |
| | Duration of output short circuit ⁽⁵⁾ | Unlimited | | |
| T _J | Operating virtual junction temperature | | 150 | °C |

- (1) Stresses beyond those listed under *Absolute Maximum Ratings* may cause permanent damage to the device. These are stress ratings only, and functional operation of the device at these or any other conditions beyond those indicated under *Recommended Operating Conditions* is not implied. Exposure to absolute-maximum-rated conditions for extended periods may affect device reliability.
- (2) All voltage values, except differential voltages, are with respect to the midpoint between V_{CC+} and V_{CC-}.
- (3) The magnitude of the input voltage must never exceed the magnitude of the supply voltage.
- (4) Excessive input current will flow if a differential input voltage in excess of approximately 0.6 V is applied between the inputs, unless some limiting resistance is used.
- (5) The output may be shorted to ground or either power supply. Temperature and/or supply voltages must be limited to ensure the maximum dissipation rating is not exceeded.

7.2 Handling Ratings

| PARAMETER | DEFINITION | MIN | MAX | UNIT |
|--------------------|---|-----|-----|------|
| T _{stg} | Storage temperature range | -65 | 150 | °C |
| V _(ESD) | Human-Body Model (HBM) ⁽¹⁾ | 0 | 2.5 | kV |
| | Charged-Device Model (CDM) ⁽²⁾ | 0 | 1.5 | |

- (1) JEDEC document JEP155 states that 500-V HBM allows safe manufacturing with a standard ESD control process.
- (2) JEDEC document JEP157 states that 250-V CDM allows safe manufacturing with a standard ESD control process.

7.3 Recommended Operating Conditions

| | | MIN | MAX | UNIT |
|------------------|--------------------------------------|-----|-----|------|
| V _{CC-} | Supply voltage | -5 | -18 | V |
| V _{CC+} | | 5 | 18 | |
| T _A | Operating free-air temperature range | -40 | 85 | °C |

7.4 Thermal Information

| THERMAL METRIC ⁽¹⁾ | | LM833 | | | UNIT |
|-------------------------------|--|---------------|-----|----|------|
| | | D | DGK | P | |
| | | 8 PINS | | | |
| Rθ _{JA} | Junction-to-ambient thermal resistance ⁽²⁾⁽³⁾ | 97 | 172 | 85 | °C/W |

- (1) For more information about traditional and new thermal metrics, see the *IC Package Thermal Metrics* application report ([SPRA953](#)).
- (2) Maximum power dissipation is a function of T_{J(max)}, θ_{JA}, and T_A. The maximum allowable power dissipation at any allowable ambient temperature is P_D = (T_{J(max)} – T_A) / θ_{JA}. Operating at the absolute maximum T_J of 150°C can affect reliability.
- (3) The package thermal impedance is calculated in accordance with JESD 51-7.

7.5 Electrical Characteristics

 $V_{CC-} = -15\text{ V}$, $V_{CC+} = 15\text{ V}$, $T_A = 25^\circ\text{C}$ (unless otherwise noted)

| PARAMETER | | TEST CONDITIONS | | MIN | TYP | MAX | UNIT | |
|-----------------|---|---|---|-----------|----------|-------|------------------------------|----|
| V_{IO} | Input offset voltage | $V_O = 0$, $R_S = 10\ \Omega$, $V_{CM} = 0$ | $T_A = 25^\circ\text{C}$ | 0.15 | 2 | 3 | mV | |
| | | | $T_A = -40^\circ\text{C}$ to 85°C | | | | | |
| αV_{IO} | Input offset voltage temperature coefficient | $V_O = 0$, $R_S = 10\ \Omega$, $V_{CM} = 0$ | $T_A = -40^\circ\text{C}$ to 85°C | | 2 | | $\mu\text{V}/^\circ\text{C}$ | |
| I_{IB} | Input bias current | $V_O = 0$, $V_{CM} = 0$ | $T_A = 25^\circ\text{C}$ | 300 | 750 | 800 | nA | |
| | | | $T_A = -40^\circ\text{C}$ to 85°C | | | | | |
| I_{IO} | Input offset current | $V_O = 0$, $V_{CM} = 0$ | $T_A = 25^\circ\text{C}$ | 25 | 150 | 175 | nA | |
| | | | $T_A = -40^\circ\text{C}$ to 85°C | | | | | |
| V_{ICR} | Common-mode input voltage range | $\Delta V_{IO} = 5\text{ mV}$, $V_O = 0$ | | ± 13 | ± 14 | | V | |
| A_{VD} | Large-signal differential voltage amplification | $R_L \geq 2\text{ k}\Omega$, $V_O = \pm 10\text{ V}$ | $T_A = 25^\circ\text{C}$ | 90 | 110 | 85 | dB | |
| | | | $T_A = -40^\circ\text{C}$ to 85°C | | | | | |
| V_{OM} | Maximum output voltage swing | $V_{ID} = \pm 1\text{ V}$ | $R_L = 600\ \Omega$ | V_{OM+} | 10.7 | | V | |
| | | | | V_{OM-} | -11.9 | | | |
| | | | $R_L = 2000\ \Omega$ | V_{OM+} | 13.2 | 13.8 | | |
| | | | | V_{OM-} | -13.2 | -13.7 | | |
| | | | $R_L = 10,000\ \Omega$ | V_{OM+} | 13.5 | 14.1 | | |
| | | | | V_{OM-} | -14 | -14.6 | | |
| CMMR | Common-mode rejection ratio | $V_{IN} = \pm 13\text{ V}$ | | 80 | 100 | | dB | |
| $k_{SVR}^{(1)}$ | Supply-voltage rejection ratio | $V_{CC+} = 5\text{ V}$ to 15 V , $V_{CC-} = -5\text{ V}$ to -15 V | | 80 | 105 | | dB | |
| I_{OS} | Output short-circuit current | $ V_{ID} = 1\text{ V}$, Output to GND | Source current | 15 | 29 | -20 | -37 | mA |
| | | | Sink current | | | | | |
| I_{CC} | Supply current (per channel) | $V_O = 0$ | $T_A = 25^\circ\text{C}$ | 2.05 | 2.5 | 2.75 | mA | |
| | | | $T_A = -40^\circ\text{C}$ to 85°C | | | | | |

(1) Measured with $V_{CC\pm}$ differentially varied at the same time

7.6 Operating Characteristics

 $V_{CC-} = -15\text{ V}$, $V_{CC+} = 15\text{ V}$, $T_A = 25^\circ\text{C}$ (unless otherwise noted)

| PARAMETER | | TEST CONDITIONS | | MIN | TYP | MAX | UNIT |
|-----------|--------------------------------|---|-----------------------|--------|-----|-----|------------------------|
| SR | Slew rate at unity gain | $A_{VD} = 1$, $V_{IN} = -10\text{ V}$ to 10 V , $R_L = 2\text{ k}\Omega$, $C_L = 100\text{ pF}$ | | 5 | 7 | | V/ μs |
| GBW | Gain bandwidth product | $f = 100\text{ kHz}$ | | 10 | 16 | | MHz |
| B_1 | Unity gain frequency | Open loop | | | 9 | | MHz |
| G_m | Gain margin | $R_L = 2\text{ k}\Omega$ | $C_L = 0\text{ pF}$ | -11 | | -6 | dB |
| | | | $C_L = 100\text{ pF}$ | | | | |
| Φ_m | Phase margin | $R_L = 2\text{ k}\Omega$ | $C_L = 0\text{ pF}$ | 55 | | 40 | degrees |
| | | | $C_L = 100\text{ pF}$ | | | | |
| | Amp-to-amp isolation | $f = 20\text{ Hz}$ to 20 kHz | | -120 | | | dB |
| | Power bandwidth | $V_O = 27\text{ V}_{(PP)}$, $R_L = 2\text{ k}\Omega$, $\text{THD} \leq 1\%$ | | 120 | | | kHz |
| THD | Total harmonic distortion | $V_O = 3\text{ V}_{\text{rms}}$, $A_{VD} = 1$, $R_L = 2\text{ k}\Omega$, $f = 20\text{ Hz}$ to 20 kHz | | 0.002% | | | |
| z_o | Open-loop output impedance | $V_O = 0$, $f = 9\text{ MHz}$ | | 37 | | | Ω |
| r_{id} | Differential input resistance | $V_{CM} = 0$ | | 175 | | | k Ω |
| C_{id} | Differential input capacitance | $V_{CM} = 0$ | | 12 | | | pF |
| V_n | Equivalent input noise voltage | $f = 1\text{ kHz}$, $R_S = 100\ \Omega$ | | 4.5 | | | nV/ $\sqrt{\text{Hz}}$ |
| I_n | Equivalent input noise current | $f = 1\text{ kHz}$ | | 0.5 | | | pA/ $\sqrt{\text{Hz}}$ |

7.7 Typical Characteristics

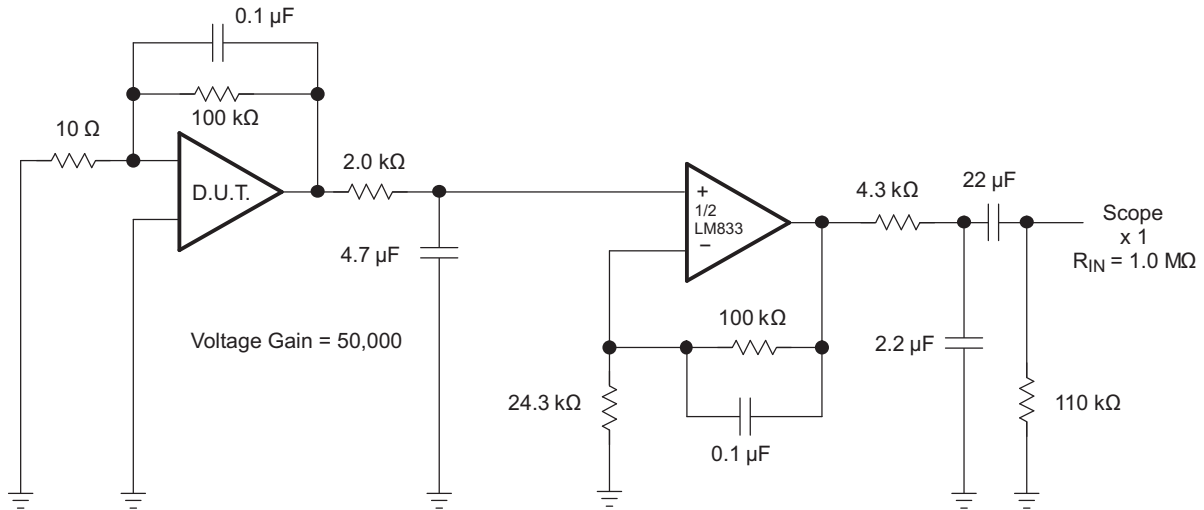

NOTE: All capacitors are non-polarized.

Figure 1. Voltage Noise Test Circuit (0.1 Hz to 10 Hz)

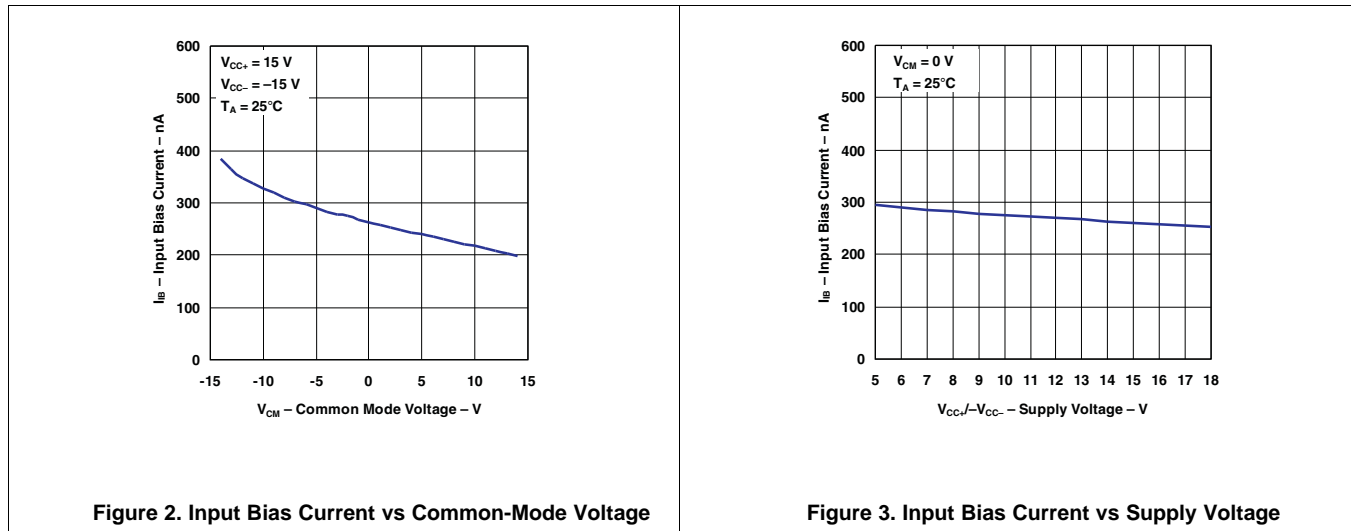

Typical Characteristics (continued)

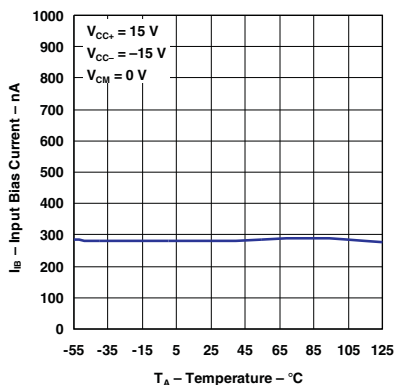

Figure 4. Input Bias Current vs Temperature

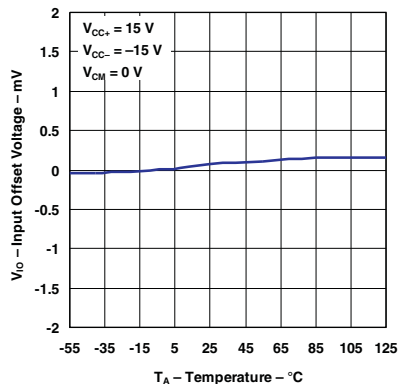

Figure 5. Input Offset Voltage vs Temperature

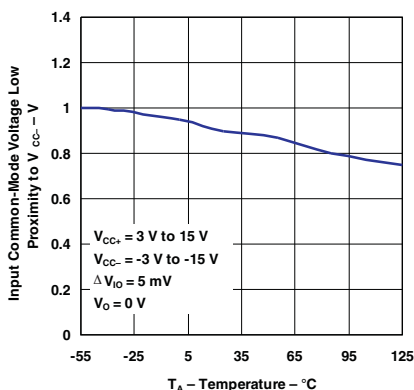

Figure 6. Input Common-Mode Voltage Low Proximity to V_{CC-} vs Temperature

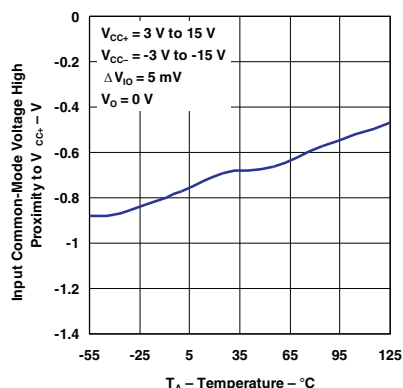

Figure 7. Input Common-Mode Voltage High Proximity to V_{CC+} vs Temperature

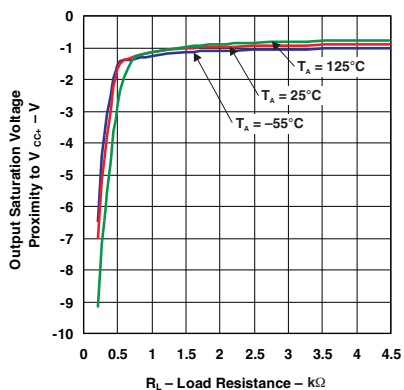

Figure 8. Output Saturation Voltage Proximity to V_{CC+} vs Load Resistance

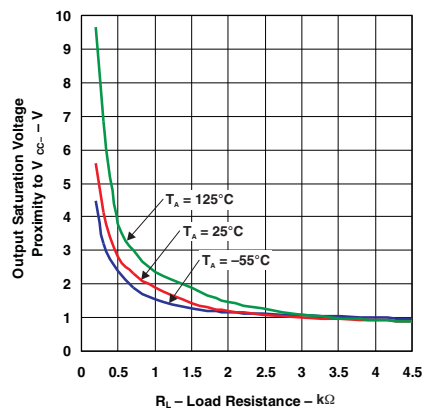

Figure 9. Output Saturation Voltage Proximity to V_{CC-} vs Load Resistance

Typical Characteristics (continued)

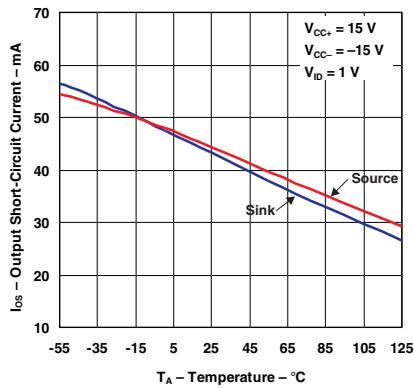

Figure 10. Output Short-Circuit Current vs Temperature

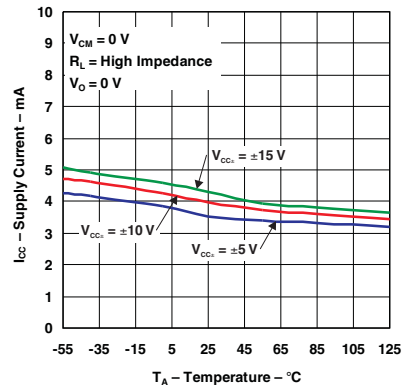

Figure 11. Supply Current vs Temperature

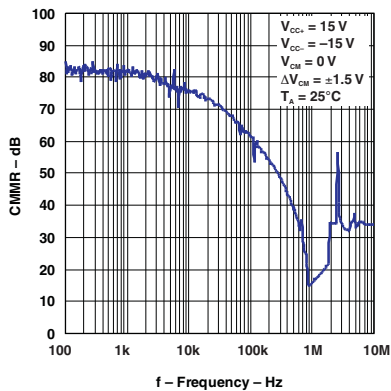

Figure 12. CMRR vs Frequency

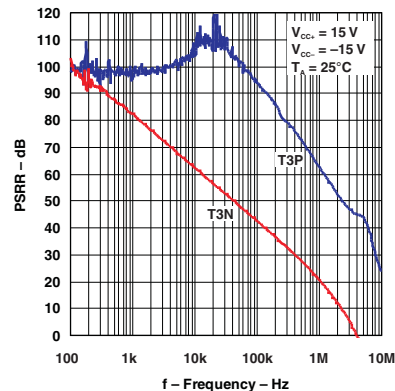

Figure 13. PSSR vs Frequency

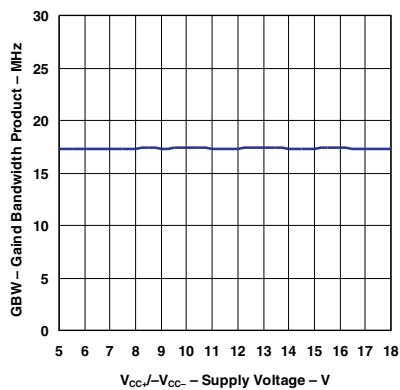

Figure 14. Gain Bandwidth Product vs Supply Voltage

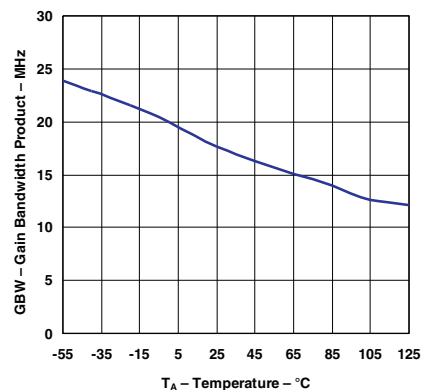

Figure 15. Gain Bandwidth Product vs Temperature

Typical Characteristics (continued)

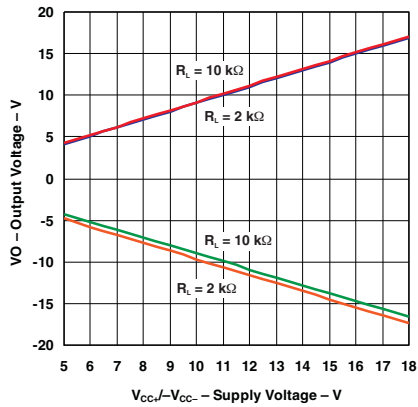

Figure 16. Output Voltage vs Supply Voltage

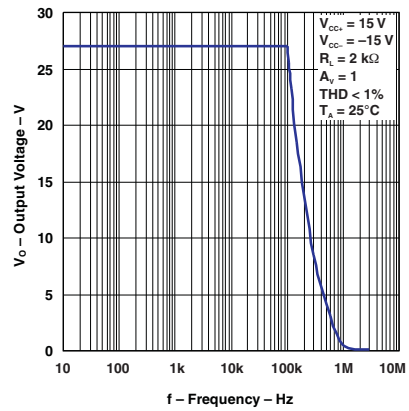

Figure 17. Output Voltage vs Frequency

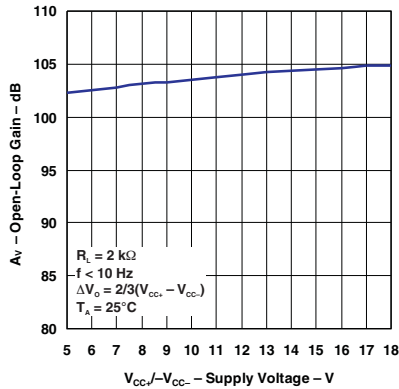

Figure 18. Open-Loop Gain vs Supply Voltage

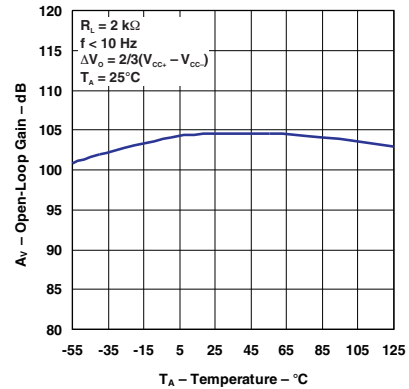

Figure 19. Open-Loop Gain vs Temperature

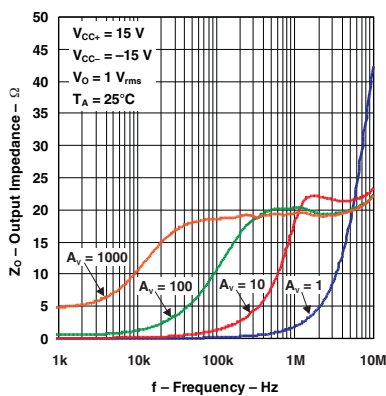

Figure 20. Output Impedance vs Frequency

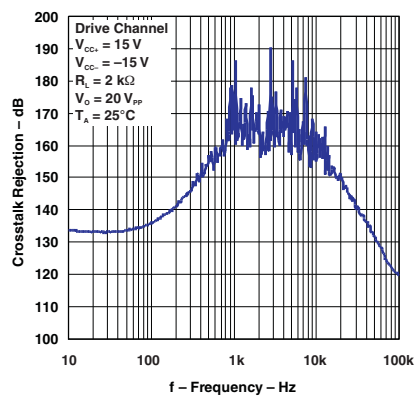

Figure 21. Crosstalk Rejection vs Frequency

Typical Characteristics (continued)

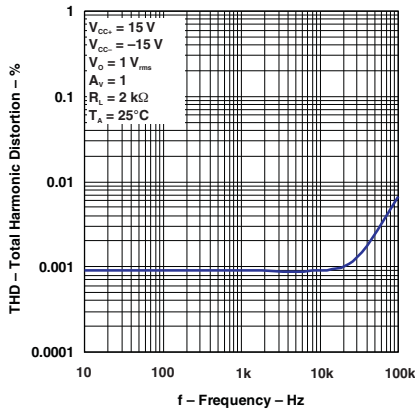

Figure 22. Total Harmonic Distortion vs Frequency

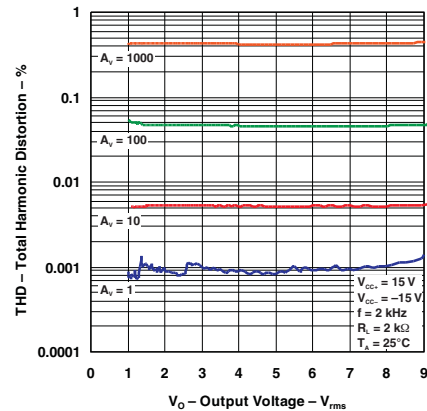

Figure 23. Total Harmonic Distortion vs Output Voltage

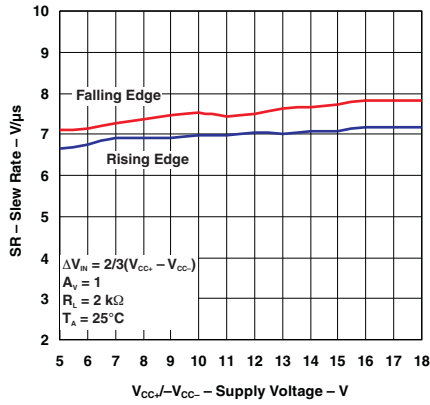

Figure 24. Slew Rate vs Supply Voltage

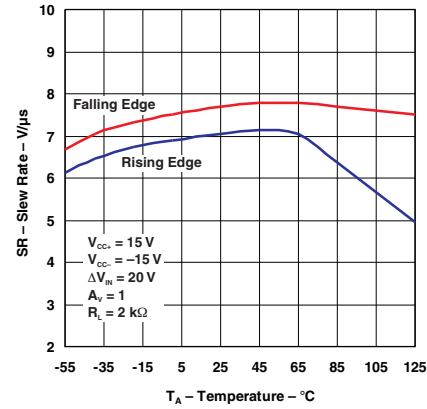

Figure 25. Slew Rate vs Temperature

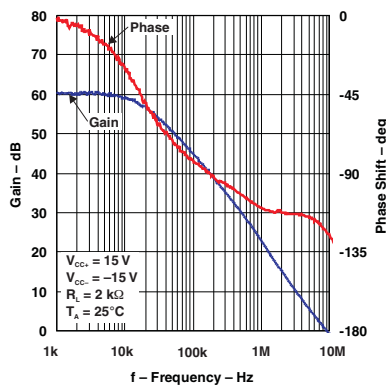

Figure 26. Gain and Phase vs Frequency

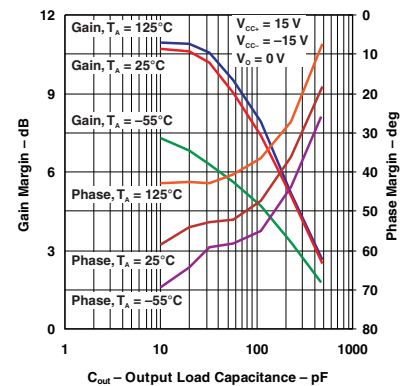

Figure 27. Gain and Phase Margin vs Output Load Capacitance

Typical Characteristics (continued)

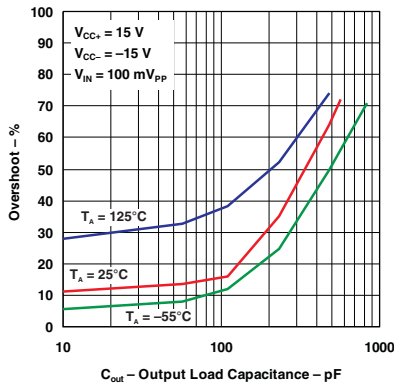

Figure 28. Overshoot vs Output Load Capacitance

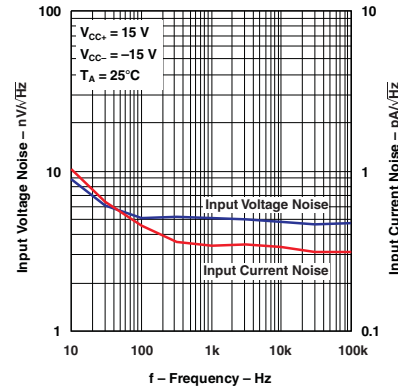

Figure 29. Input Voltage and Current Noise vs Frequency

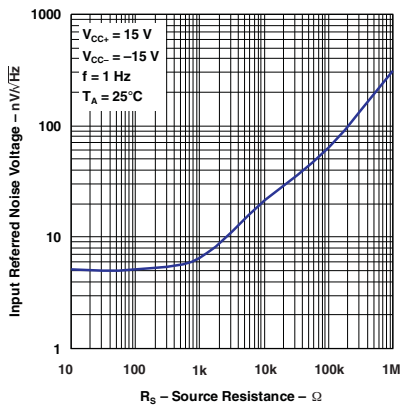

Figure 30. Input Referred Noise Voltage vs Source Resistance

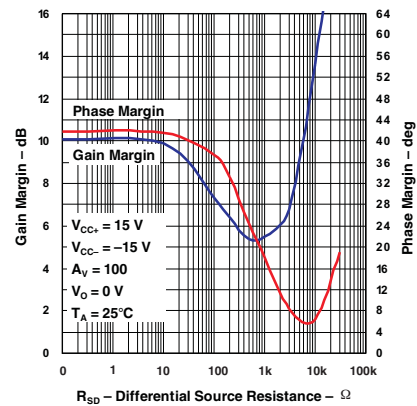

Figure 31. Gain and Phase Margin vs Differential Source Resistance

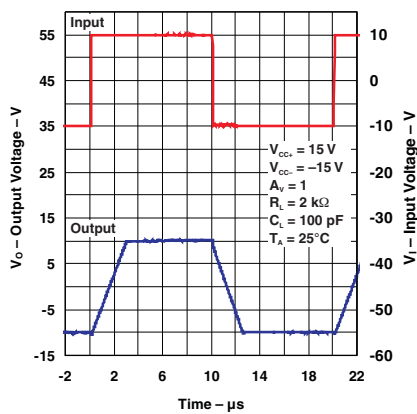

Figure 32. Large Signal Transient Response ($A_V = 1$)

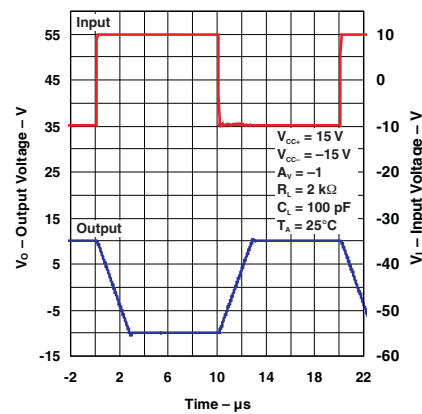
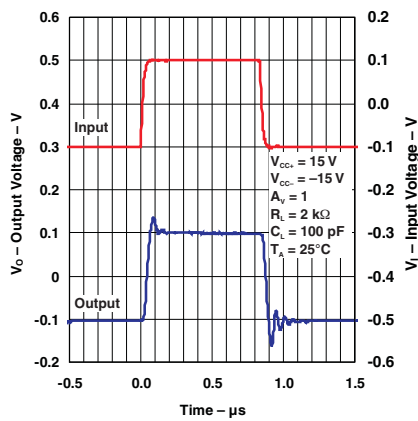
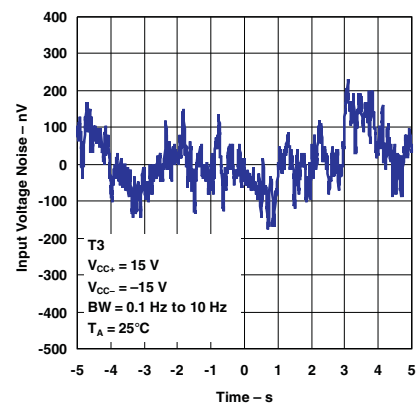

Figure 33. Large Signal Transient Response ($A_V = -1$)

Typical Characteristics (continued)

Figure 34. Small Signal Transient Response

Figure 35. Low-Frequency Noise

8 Detailed Description

8.1 Overview

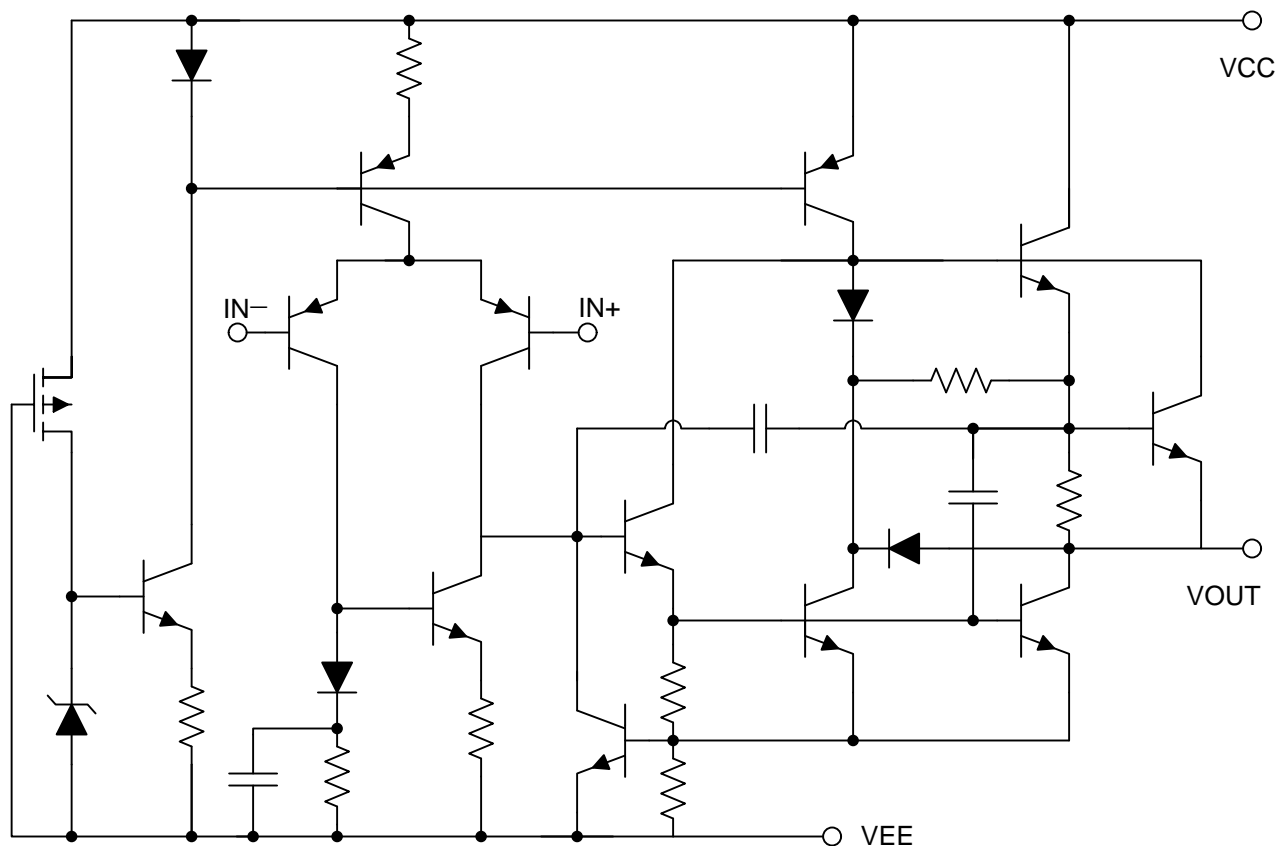
The LM833 device is a dual operational amplifier with high-performance specifications for use in quality audio and data-signal applications. This device operates over a wide range of single- and dual-supply voltage with low noise, high-gain bandwidth, and high slew rate. Additional features include low total harmonic distortion, excellent phase and gain margins, large output voltage swing with no deadband crossover distortions, and symmetrical sink/source performance. The dual amplifiers are utilized widely in circuit of audio optimized for all preamp and high-level stages in PCM and HiFi systems. The LM833 device is pin-for-pin compatible with industry-standard dual operation amplifiers' pin assignments. With addition of a preamplifier, the gain of the power stage can be greatly reduced to improve performance.

8.2 Functional Block Diagram



8.3 Feature Description

8.3.1 Operating Voltage

The LM833 operational amplifier is fully specified and ensured for operation from ± 5 V to ± 18 V. In addition, many specifications apply from -40°C to 85°C . Parameters that vary significantly with operating voltages or temperature are shown in [Absolute Maximum Ratings](#).

8.3.2 High Gain Bandwidth Product

Gain bandwidth product is found by multiplying the measured bandwidth of an amplifier by the gain at which that bandwidth was measured. The LM833 has a high gain bandwidth of 16 MHz which stays relatively stable over a wide range of supply voltages. Parameters that vary significantly with temperature are shown in [Figure 14](#).

8.3.3 Low Total Harmonic Distortion

Harmonic distortions to an audio signal are created by electronic components in a circuit. Total harmonic distortion (THD) is a measure of harmonic distortions accumulated by a signal in an audio system. The LM833 has a very low THD of 0.002% meaning that the LM833 will add little harmonic distortion when used in audio signal applications. More specific characteristics are shown in [Figure 22](#).

8.4 Device Functional Modes

The LM833 is powered on when the supply is connected. It can be operated as a single supply operational amplifier or dual supply amplifier depending on the application.

9 Application and Implementation

NOTE

Information in the following applications sections is not part of the TI component specification, and TI does not warrant its accuracy or completeness. TI's customers are responsible for determining suitability of components for their purposes. Customers should validate and test their design implementation to confirm system functionality.

9.1 Application Information

An application of the LM833 is the two stage RIAA Phono Preamplifier. A primary task of the phono preamplifier is to provide gain (usually 30 to 40 dB at 1 kHz) and accurate amplitude and phase equalization to the signal from a moving magnet or a moving coil cartridge. In addition to the amplification and equalization functions, the phono preamp must not add significant noise or distortion to the signal from the cartridge. The circuit shown in Figure 36 uses two amplifiers, fulfills these qualifications, and has greatly improved performance over a single-amplifier design.

9.2 Typical Application

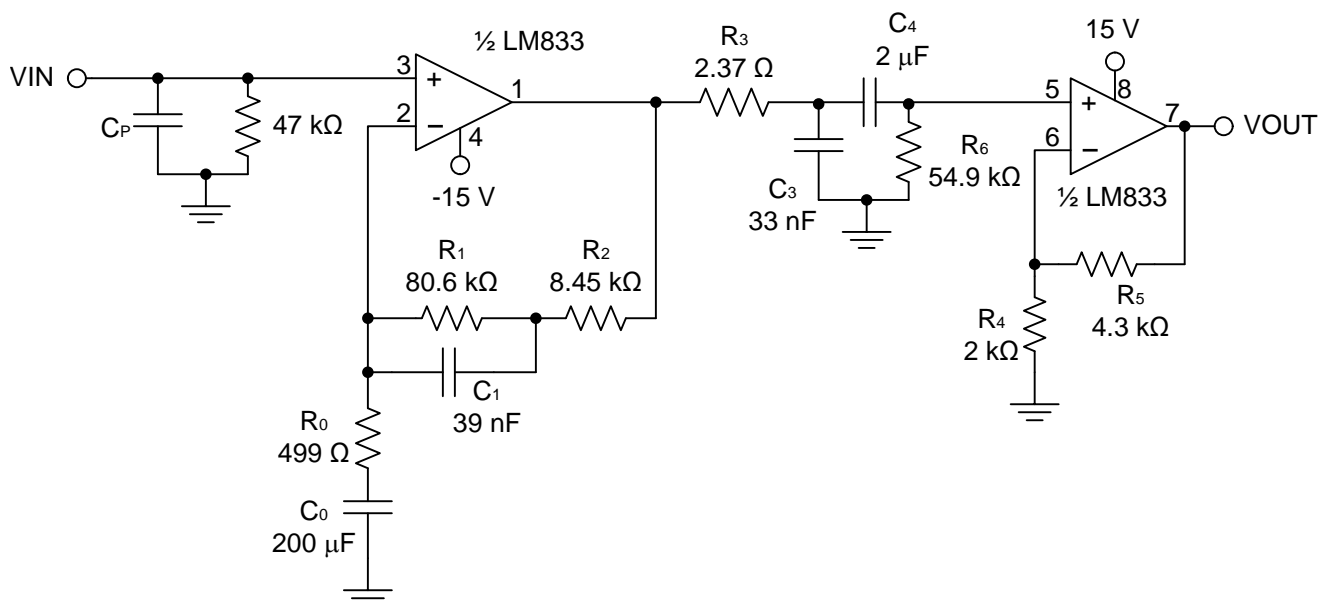

Figure 36. RIAA Phono Preamplifier

9.2.1 Design Requirements

- Supply Voltage = ± 15 V
- Low-Frequency -3 dB corner of the first amplifier (f_0) > 20 Hz (below audible range)
- Low-Frequency -3 dB corner of the second stage (f_L) = 20.2 Hz

9.2.2 Detailed Design Procedure

9.2.2.1 Introduction to Design Method

Equation 1 through Equation 5 show the design equations for the preamplifier.

$$R_1 = 8.058 R_0 A_1$$

where

- A_1 is the 1 kHz voltage gain of the first amplifier (1)

Typical Application (continued)

$$C_1 = \frac{3.18 \times 10^{-3}}{R_1} \quad (2)$$

$$R_2 = \frac{R_1}{9} - R_0 \quad (3)$$

$$C_3 = 7.5 \times 10^{-5} \frac{(R_3 + R_6)}{R_3 R_6} = \frac{7.5 \times 10^{-5}}{R_P} \quad (4)$$

$$C_4 = \frac{1}{2\pi f_L (R_3 + R_6)}$$

where

- f_L is the low-frequency -3 dB corner of the second stage (5)

For standard RIAA preamplifiers, f_L should be kept well below the audible frequency range. If the preamplifier is to follow the IEC recommendation (IEC Publication 98, Amendment #4), f_L should equal 20.2 Hz.

$$A_{V2} = 1 + \frac{R_5}{R_4}$$

where

- A_{V2} is the voltage gain of the second amplifier (6)

$$C_0 \approx \frac{1}{2\pi f_0 R_0}$$

where

- f_0 is the low-frequency -3 dB corner of the first amplifier (7)

This should be kept well below the audible frequency range.

A design procedure is shown below with an illustrative example using 1% tolerance E96 components for close conformance to the ideal RIAA curve. Because 1% tolerance capacitors are often difficult to find except in 5% or 10% standard values, the design procedure calls for re-calculation of a few component values so that standard capacitor values can be used.

9.2.2.2 RIAA Phono Preamplifier Design Procedure

A design procedure is shown below with an illustrative example using 1% tolerance E96 components for close conformance to the ideal RIAA curve. Since 1% tolerance capacitors are often difficult to find except in 5% or 10% standard values, the design procedure calls for re-calculation of a few component values so that standard capacitor values can be used.

Choose R_0 . R_0 should be small for minimum noise contribution, but not so small that the feedback network excessively loads the amplifier.

Example: Choose $R_0 = 500$

Choose 1 kHz gain, A_{V1} of first amplifier. This will typically be around 20 dB to 30 dB.

Example: Choose $A_{V1} = 26 \text{ dB} = 20$

Calculate $R_1 = 8.058 R_0 A_{V1}$

Example: $R_1 = 8.058 \times 500 \times 20 = 80.58 \text{ k}$

$$\text{Calculate } C_1 = \frac{3.18 \times 10^{-3}}{R_1} \quad (8)$$

$$\text{Example: } C_1 = \frac{3.18 \times 10^{-3}}{8.058 \times 10^4} = 0.03946 \mu\text{F} \quad (9)$$

If C_1 is not a convenient value, choose the nearest convenient value and calculate a new R_1 from [Equation 10](#).

Typical Application (continued)

$$R_1 = \frac{3.18 \times 10^{-3}}{C_1} \quad (10)$$

Example: New $C_1 = 0.039 \mu\text{F}$.

$$\text{New } R_1 = \frac{3.18 \times 10^{-3}}{3.9 \times 10^{-8}} = 81.54 \text{ k}$$

$$\text{Use } R_1 = 80.6 \text{ k} \quad (11)$$

Calculate a new value for R_0 from [Equation 12](#).

$$R_0 = \frac{R_1}{8.058 A_{V1}} \quad (12)$$

$$\text{Example: New } R_0 = \frac{8.06 \times 10^4}{8.058 \times 20} = 498.8 \quad (13)$$

Use $R_0 = 499$.

$$\text{Calculate } R_2 = \frac{R_1}{9} - R_0$$

$$\text{Example: } R_2 = \frac{8.06 \times 10^4}{9} - 499 = 8456.56 \quad (14)$$

Use $R_2 = 8.45 \text{ K}$.

Choose a convenient value for C_3 in the range from $0.01 \mu\text{F}$ to $0.05 \mu\text{F}$.

Example: $C_3 = 0.033 \mu\text{F}$

$$\text{Calculate } R_P = \frac{7.5 \times 10^{-5}}{C_3}$$

$$\text{Example: } R_P = \frac{7.5 \times 10^{-5}}{3.3 \times 10^{-8}} = 2.273 \text{ k} \quad (15)$$

Choose a standard value for R_3 that is slightly larger than R_P .

Example: $R_3 = 2.37 \text{ k}$

Calculate R_6 from $1 / R_6 = 1 / R_P - 1 / R_3$

Example: $R_6 = 55.36 \text{ k}$

Use 54.9 k

Calculate C_4 for low-frequency rolloff below 1 Hz from design [Equation 5](#).

Example: $C_4 = 2 \mu\text{F}$. Use a good quality mylar, polystyrene, or polypropylene.

Choose gain of second amplifier.

Example: The 1 kHz gain up to the input of the second amplifier is about 26 dB for this example. For an overall 1 kHz gain equal to about 36 dB we choose:

$$A_{V2} = 10 \text{ dB} = 3.16$$

Choose value for R_4 .

Example: $R_4 = 2 \text{ k}$

Calculate $R_5 = (A_{V2} - 1) R_4$

Typical Application (continued)

Example: $R_5 = 4.32 \text{ k}$

Use $R_5 = 4.3 \text{ k}$

Calculate C_0 for low-frequency rolloff below 1 Hz from design [Equation 7](#).

Example: $C_0 = 200 \mu\text{F}$

9.2.3 Application Curves for Output Characteristics

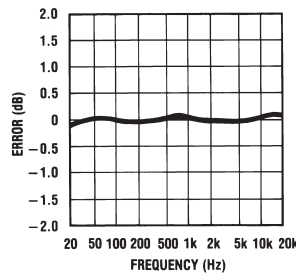

The maximum observed error for the prototype was 0.1 dB.

Figure 37. Deviation from Ideal RIAA Response for Circuit of Figure 36 Using 1% Resistors

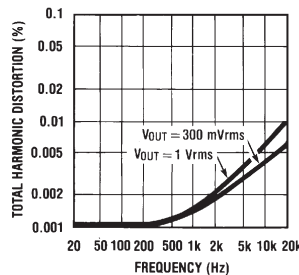

The lower curve is for an output level of 300 mV_{rms} and the upper curve is for an output level of 1 V_{rms}.

Figure 38. THD of Circuit in Figure 36 as a Function of Frequency

9.3 Typical Application — Reducing Oscillation from High-Capacitive Loads

While all the previously stated operating characteristics are specified with 100-pF load capacitance, the LM833 device can drive higher-capacitance loads. However, as the load capacitance increases, the resulting response pole occurs at lower frequencies, causing ringing, peaking, or oscillation. The value of the load capacitance at which oscillation occurs varies from lot-to-lot. If an application appears to be sensitive to oscillation due to load capacitance, adding a small resistance in series with the load should alleviate the problem (see [Figure 39](#)).

9.3.1 Test Schematic

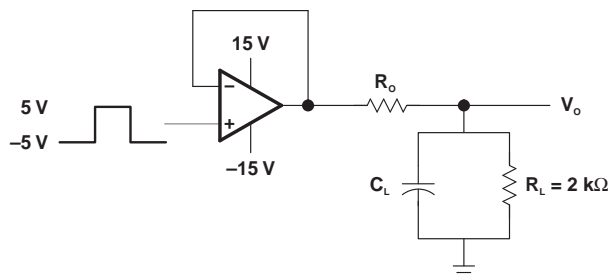
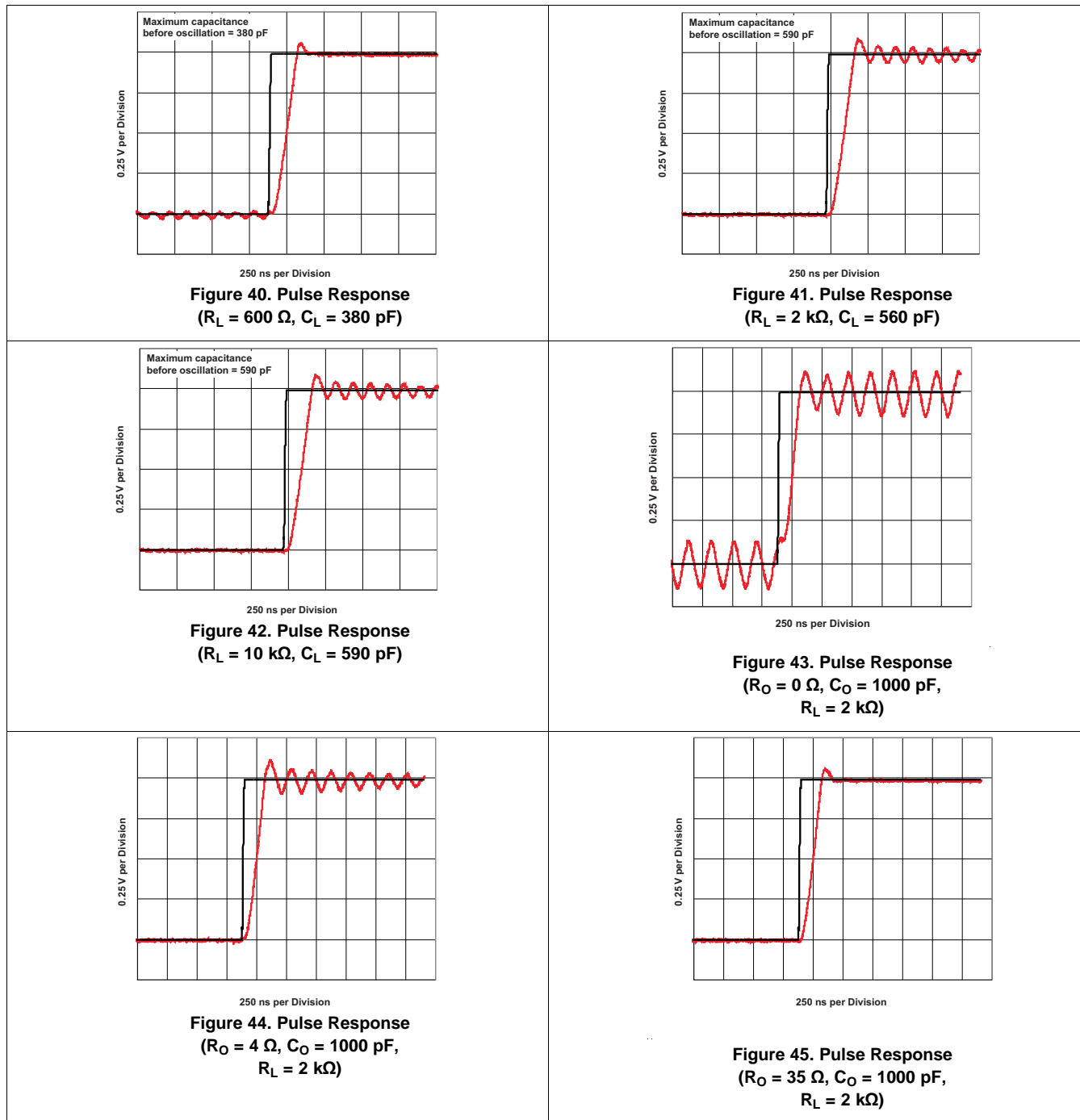

Figure 39. Capacitive Load Testing Circuit

Typical Application — Reducing Oscillation from High-Capacitive Loads (continued)

9.3.2 Output Characteristics

Figure 40 through Figure 45 demonstrate the effect adding this small resistance has on the ringing in the output signal.



10 Power Supply Recommendations

The LM833 is specified for operation from 10 to 36 V (± 5 to ± 18 V); many specifications apply from -40°C to 85°C . The [Typical Characteristics](#) section presents parameters that can exhibit significant variance with regard to operating voltage or temperature.

CAUTION

Supply voltages larger than 36 V can permanently damage the device (see [Absolute Maximum Ratings](#)).

Place 0.1- μF bypass capacitors close to the power-supply pins to reduce errors coupling in from noisy or high impedance power supplies. For more detailed information on bypass capacitor placement, refer to the [Layout](#) section.

11 Layout

11.1 Layout Guidelines

For best operational performance of the device, use good PCB layout practices, including:

- Noise can propagate into analog circuitry through the power pins of the circuit as a whole and the operational amplifier. Bypass capacitors are used to reduce the coupled noise by providing low impedance power sources local to the analog circuitry.
 - Connect low-ESR, 0.1- μF ceramic bypass capacitors between each supply pin and ground, placed as close to the device as possible. A single bypass capacitor from $V+$ to ground is applicable for single supply applications.
- Separate grounding for analog and digital portions of circuitry is one of the simplest and most-effective methods of noise suppression. One or more layers on multilayer PCBs are usually devoted to ground planes. A ground plane helps distribute heat and reduces EMI noise pickup. Make sure to physically separate digital and analog grounds, paying attention to the flow of the ground current. For more detailed information, refer to [Circuit Board Layout Techniques](#), (SLOA089).
- To reduce parasitic coupling, run the input traces as far away from the supply or output traces as possible. If it is not possible to keep them separate, it is much better to cross the sensitive trace perpendicular as opposed to in parallel with the noisy trace.
- Place the external components as close to the device as possible. Keeping R_F and R_G close to the inverting input minimizes parasitic capacitance, as shown in [Layout Example](#).
- Keep the length of input traces as short as possible. Always remember that the input traces are the most sensitive part of the circuit.
- Consider a driven, low-impedance guard ring around the critical traces. A guard ring can significantly reduce leakage currents from nearby traces that are at different potentials.

11.2 Layout Example

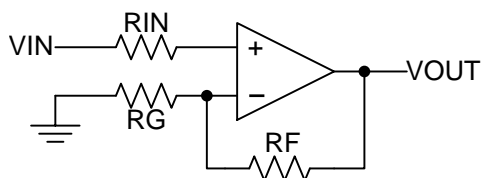

Figure 46. Operational Amplifier Schematic for Noninverting Configuration

Layout Example (continued)

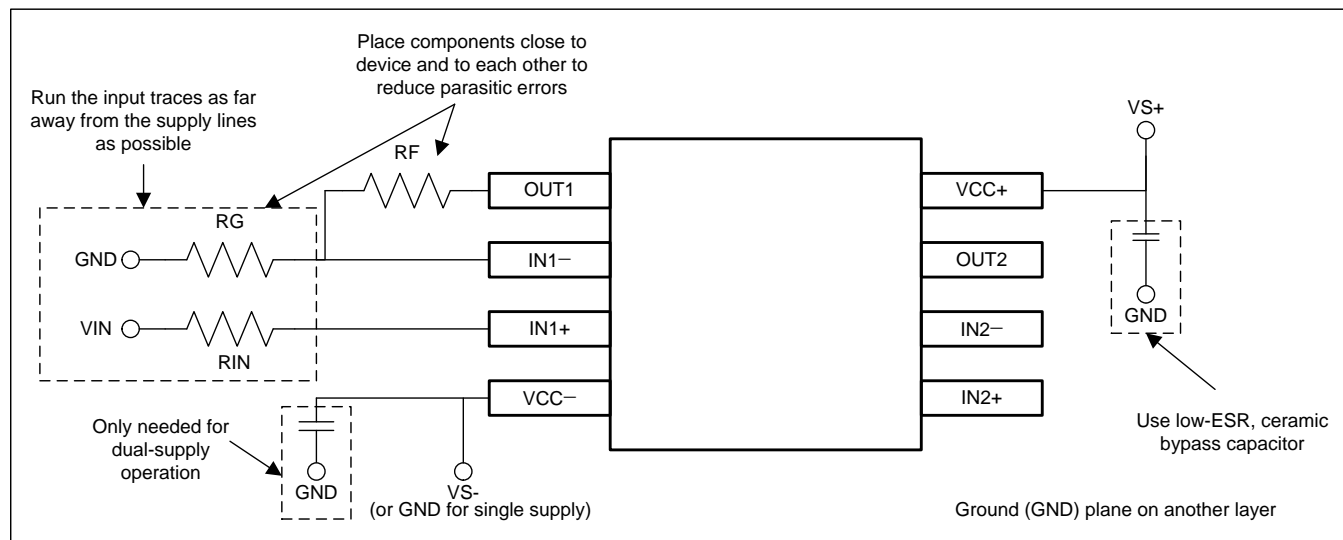

Figure 47. Operational Amplifier Board Layout for Noninverting Configuration

12 Device and Documentation Support

12.1 Trademarks

All trademarks are the property of their respective owners.

12.2 Electrostatic Discharge Caution



These devices have limited built-in ESD protection. The leads should be shorted together or the device placed in conductive foam during storage or handling to prevent electrostatic damage to the MOS gates.

12.3 Glossary

[SLYZ022](#) — *TI Glossary*.

This glossary lists and explains terms, acronyms, and definitions.

13 Mechanical, Packaging, and Orderable Information

The following pages include mechanical, packaging, and orderable information. This information is the most current data available for the designated devices. This data is subject to change without notice and revision of this document. For browser-based versions of this data sheet, refer to the left-hand navigation.

PACKAGING INFORMATION

| Orderable Device | Status (1) | Package Type | Package Drawing | Pins | Package Qty | Eco Plan (2) | Lead/Ball Finish (6) | MSL Peak Temp (3) | Op Temp (°C) | Device Marking (4/5) | Samples |
|------------------|---------------|--------------|-----------------|------|-------------|-------------------------|-------------------------|----------------------|--------------|-------------------------|-------------------------|
| LM833D | ACTIVE | SOIC | D | 8 | 75 | Green (RoHS & no Sb/Br) | NIPDAU | Level-1-260C-UNLIM | -40 to 85 | LM833 | Samples |
| LM833DGKR | ACTIVE | VSSOP | DGK | 8 | 2500 | Green (RoHS & no Sb/Br) | NIPDAU | Level-1-260C-UNLIM | -40 to 85 | RSU | Samples |
| LM833DGKT | ACTIVE | VSSOP | DGK | 8 | 250 | Green (RoHS & no Sb/Br) | NIPDAU | Level-1-260C-UNLIM | -40 to 85 | RSU | Samples |
| LM833DR | ACTIVE | SOIC | D | 8 | 2500 | Green (RoHS & no Sb/Br) | NIPDAU | Level-1-260C-UNLIM | -40 to 85 | LM833 | Samples |
| LM833P | ACTIVE | PDIP | P | 8 | 50 | Green (RoHS & no Sb/Br) | NIPDAU | N / A for Pkg Type | -40 to 85 | LM833P | Samples |

(1) The marketing status values are defined as follows:

ACTIVE: Product device recommended for new designs.

LIFEBUY: TI has announced that the device will be discontinued, and a lifetime-buy period is in effect.

NRND: Not recommended for new designs. Device is in production to support existing customers, but TI does not recommend using this part in a new design.

PREVIEW: Device has been announced but is not in production. Samples may or may not be available.

OBsolete: TI has discontinued the production of the device.

(2) **RoHS:** TI defines "RoHS" to mean semiconductor products that are compliant with the current EU RoHS requirements for all 10 RoHS substances, including the requirement that RoHS substance do not exceed 0.1% by weight in homogeneous materials. Where designed to be soldered at high temperatures, "RoHS" products are suitable for use in specified lead-free processes. TI may reference these types of products as "Pb-Free".

RoHS Exempt: TI defines "RoHS Exempt" to mean products that contain lead but are compliant with EU RoHS pursuant to a specific EU RoHS exemption.

Green: TI defines "Green" to mean the content of Chlorine (Cl) and Bromine (Br) based flame retardants meet JS709B low halogen requirements of <=1000ppm threshold. Antimony trioxide based flame retardants must also meet the <=1000ppm threshold requirement.

(3) MSL, Peak Temp. - The Moisture Sensitivity Level rating according to the JEDEC industry standard classifications, and peak solder temperature.

(4) There may be additional marking, which relates to the logo, the lot trace code information, or the environmental category on the device.

(5) Multiple Device Markings will be inside parentheses. Only one Device Marking contained in parentheses and separated by a "-" will appear on a device. If a line is indented then it is a continuation of the previous line and the two combined represent the entire Device Marking for that device.

(6) Lead/Ball Finish - Orderable Devices may have multiple material finish options. Finish options are separated by a vertical ruled line. Lead/Ball Finish values may wrap to two lines if the finish value exceeds the maximum column width.

Important Information and Disclaimer: The information provided on this page represents TI's knowledge and belief as of the date that it is provided. TI bases its knowledge and belief on information provided by third parties, and makes no representation or warranty as to the accuracy of such information. Efforts are underway to better integrate information from third parties. TI has taken and continues to take reasonable steps to provide representative and accurate information but may not have conducted destructive testing or chemical analysis on incoming materials and chemicals. TI and TI suppliers consider certain information to be proprietary, and thus CAS numbers and other limited information may not be available for release.

In no event shall TI's liability arising out of such information exceed the total purchase price of the TI part(s) at issue in this document sold by TI to Customer on an annual basis.

TAPE AND REEL INFORMATION



QUADRANT ASSIGNMENTS FOR PIN 1 ORIENTATION IN TAPE



*All dimensions are nominal

| Device | Package Type | Package Drawing | Pins | SPQ | Reel Diameter (mm) | Reel Width W1 (mm) | A0 (mm) | B0 (mm) | K0 (mm) | P1 (mm) | W (mm) | Pin1 Quadrant |
|-----------|--------------|-----------------|------|------|--------------------|--------------------|---------|---------|---------|---------|--------|---------------|
| LM833DGKR | VSSOP | DGK | 8 | 2500 | 330.0 | 12.4 | 5.3 | 3.3 | 1.3 | 8.0 | 12.0 | Q1 |
| LM833DGKT | VSSOP | DGK | 8 | 250 | 180.0 | 12.4 | 5.3 | 3.3 | 1.3 | 8.0 | 12.0 | Q1 |
| LM833DR | SOIC | D | 8 | 2500 | 330.0 | 12.4 | 6.4 | 5.2 | 2.1 | 8.0 | 12.0 | Q1 |
| LM833DR | SOIC | D | 8 | 2500 | 330.0 | 12.4 | 6.4 | 5.2 | 2.1 | 8.0 | 12.0 | Q1 |

TAPE AND REEL BOX DIMENSIONS

*All dimensions are nominal

| Device | Package Type | Package Drawing | Pins | SPQ | Length (mm) | Width (mm) | Height (mm) |
|-----------|--------------|-----------------|------|------|-------------|------------|-------------|
| LM833DGKR | VSSOP | DGK | 8 | 2500 | 346.0 | 346.0 | 35.0 |
| LM833DGKT | VSSOP | DGK | 8 | 250 | 203.0 | 203.0 | 35.0 |
| LM833DR | SOIC | D | 8 | 2500 | 367.0 | 367.0 | 35.0 |
| LM833DR | SOIC | D | 8 | 2500 | 340.5 | 338.1 | 20.6 |



D0008A

PACKAGE OUTLINE

SOIC - 1.75 mm max height

SMALL OUTLINE INTEGRATED CIRCUIT



4214825/C 02/2019

NOTES:

1. Linear dimensions are in inches [millimeters]. Dimensions in parenthesis are for reference only. Controlling dimensions are in inches. Dimensioning and tolerancing per ASME Y14.5M.
2. This drawing is subject to change without notice.
3. This dimension does not include mold flash, protrusions, or gate burrs. Mold flash, protrusions, or gate burrs shall not exceed $.006$ [0.15] per side.
4. This dimension does not include interlead flash.
5. Reference JEDEC registration MS-012, variation AA.

EXAMPLE BOARD LAYOUT

D0008A

SOIC - 1.75 mm max height

SMALL OUTLINE INTEGRATED CIRCUIT



LAND PATTERN EXAMPLE
 EXPOSED METAL SHOWN
 SCALE:8X



SOLDER MASK DETAILS

4214825/C 02/2019

NOTES: (continued)

- 6. Publication IPC-7351 may have alternate designs.
- 7. Solder mask tolerances between and around signal pads can vary based on board fabrication site.

EXAMPLE STENCIL DESIGN

D0008A

SOIC - 1.75 mm max height

SMALL OUTLINE INTEGRATED CIRCUIT



SOLDER PASTE EXAMPLE
BASED ON .005 INCH [0.125 MM] THICK STENCIL
SCALE:8X

4214825/C 02/2019

NOTES: (continued)

8. Laser cutting apertures with trapezoidal walls and rounded corners may offer better paste release. IPC-7525 may have alternate design recommendations.
9. Board assembly site may have different recommendations for stencil design.

P (R-PDIP-T8)

PLASTIC DUAL-IN-LINE PACKAGE



- NOTES:
- A. All linear dimensions are in inches (millimeters).
 - B. This drawing is subject to change without notice.
 - C. Falls within JEDEC MS-001 variation BA.

DGK (S-PDSO-G8)

PLASTIC SMALL-OUTLINE PACKAGE



- NOTES:
- A. All linear dimensions are in millimeters.
 - B. This drawing is subject to change without notice.
 - C. Body length does not include mold flash, protrusions, or gate burrs. Mold flash, protrusions, or gate burrs shall not exceed 0.15 per end.
 - D. Body width does not include interlead flash. Interlead flash shall not exceed 0.50 per side.
 - E. Falls within JEDEC MO-187 variation AA, except interlead flash.



- NOTES:
- A. All linear dimensions are in millimeters.
 - B. This drawing is subject to change without notice.
 - C. Publication IPC-7351 is recommended for alternate designs.
 - D. Laser cutting apertures with trapezoidal walls and also rounding corners will offer better paste release. Customers should contact their board assembly site for stencil design recommendations. Refer to IPC-7525 for other stencil recommendations.
 - E. Customers should contact their board fabrication site for solder mask tolerances between and around signal pads.

IMPORTANT NOTICE AND DISCLAIMER

TI PROVIDES TECHNICAL AND RELIABILITY DATA (INCLUDING DATASHEETS), DESIGN RESOURCES (INCLUDING REFERENCE DESIGNS), APPLICATION OR OTHER DESIGN ADVICE, WEB TOOLS, SAFETY INFORMATION, AND OTHER RESOURCES "AS IS" AND WITH ALL FAULTS, AND DISCLAIMS ALL WARRANTIES, EXPRESS AND IMPLIED, INCLUDING WITHOUT LIMITATION ANY IMPLIED WARRANTIES OF MERCHANTABILITY, FITNESS FOR A PARTICULAR PURPOSE OR NON-INFRINGEMENT OF THIRD PARTY INTELLECTUAL PROPERTY RIGHTS.

These resources are intended for skilled developers designing with TI products. You are solely responsible for (1) selecting the appropriate TI products for your application, (2) designing, validating and testing your application, and (3) ensuring your application meets applicable standards, and any other safety, security, or other requirements. These resources are subject to change without notice. TI grants you permission to use these resources only for development of an application that uses the TI products described in the resource. Other reproduction and display of these resources is prohibited. No license is granted to any other TI intellectual property right or to any third party intellectual property right. TI disclaims responsibility for, and you will fully indemnify TI and its representatives against, any claims, damages, costs, losses, and liabilities arising out of your use of these resources.

TI's products are provided subject to TI's Terms of Sale (www.ti.com/legal/termsofsale.html) or other applicable terms available either on ti.com or provided in conjunction with such TI products. TI's provision of these resources does not expand or otherwise alter TI's applicable warranties or warranty disclaimers for TI products.

Mailing Address: Texas Instruments, Post Office Box 655303, Dallas, Texas 75265
Copyright © 2020, Texas Instruments Incorporated