

# Silicon Hot-Carrier Diodes

## Schottky Barrier Diodes

These devices are designed primarily for high-efficiency UHF and VHF detector applications. They are readily adaptable to many other fast switching RF and digital applications. They are supplied in an inexpensive plastic package for low-cost, high-volume consumer and industrial/commercial requirements. They are also available in a Surface Mount package.

- Extremely Low Minority Carrier Lifetime –15ps(Typ)
- Very Low Capacitance –1.5pF(Max)@V<sub>R</sub>=15V
- Low Reverse Leakage –I<sub>R</sub>=13 nAdc(Typ) LMBD301

### LMBD301LT1

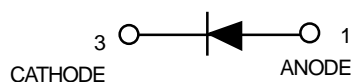
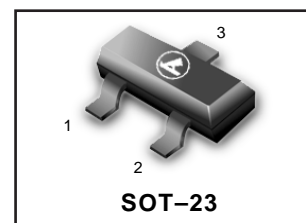

#### MAXIMUM RATINGS(T<sub>J</sub>=125°C unless otherwise noted)

Rating	symbol	LBD301		LMBD301LT1	
		value	unit	value	unit
Reverse Voltage	V <sub>R</sub>	30	Volts		
Forward Power Dissipation @TA=25 °C	P <sub>F</sub>	280	mW	200	mW
		Derate above 25 °C	2.8	mW/°C	2.0
Operating Junction Temperature Range	T <sub>J</sub>	-55 to +125		°C	
Storage Temperature Range	T <sub>stg</sub>	-55 to +150		°C	

#### DEVICE MARKING

LMBD301LT1=4T

#### ELECTRICAL CHARACTERISTICS(T<sub>A</sub>=25 °C unless otherwise noted)

Characteristic	Symbol	Min	Typ	Max	Unit
Reverse Breakdown Voltage(I <sub>R</sub> =10μA)	V <sub>(BR)R</sub>	30	—	—	Volts
Total Capacitance(V <sub>R</sub> =15V,f=1.0MHz,)Figure1	C <sub>T</sub>	—	0.9	1.5	pF
Reverse Leakage(V <sub>R</sub> =25V)Figure3	I <sub>R</sub>	—	13	200	nAdc
Forward Voltage(IF=1.0mAdc)Figure4	V <sub>F</sub>	—	0.38	0.45	Vdc
Forward Voltage(IF=10mAdc)Figure4	V <sub>F</sub>	—	0.52	0.6	Vdc

**NOTE:**LMBD301LT1 is also available in bulk packaging.Use LMBD301L as the device title to order this device in bulk.

**LMBD301LT1**

**TYPICAL ELECTRICAL CHARACTERISTICS**

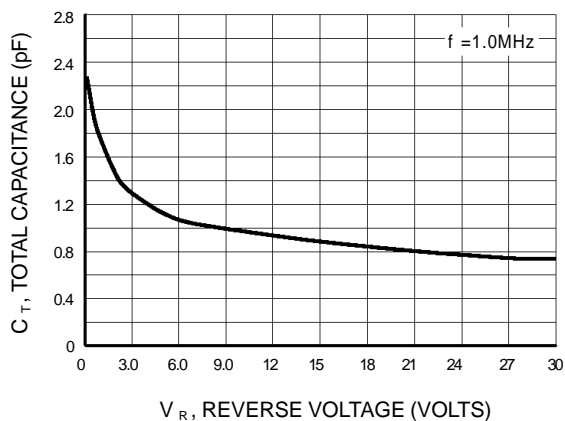

**Figure 1. Total Capacitance**

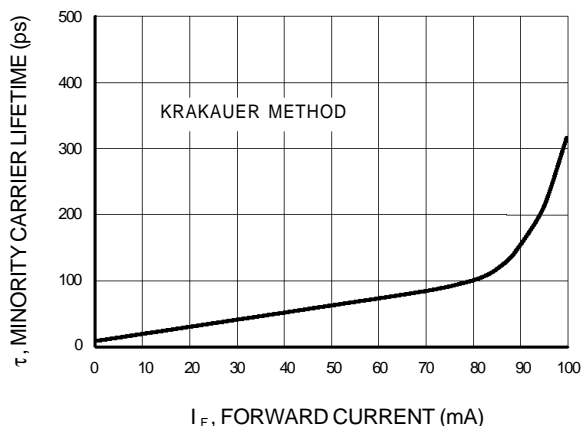

**Figure 2. Minority Carrier Lifetime**

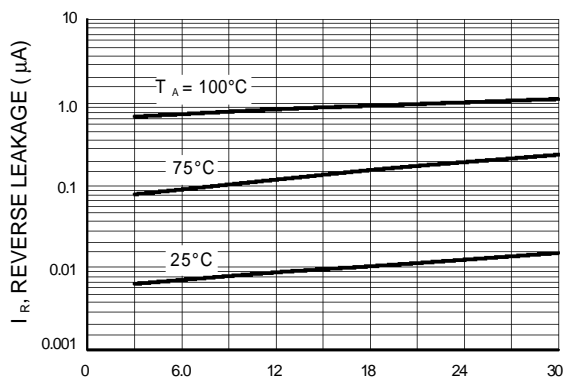

**Figure 3. Reverse Leakage**

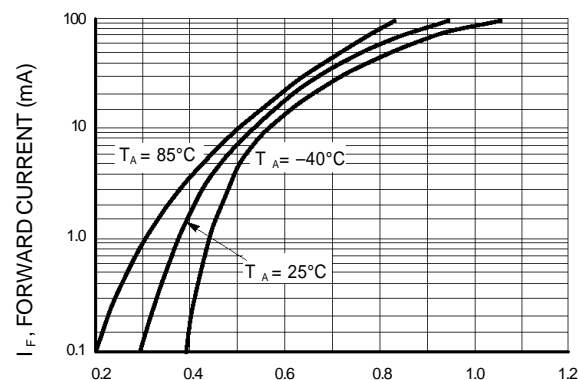

**Figure 4. Forward Voltage**

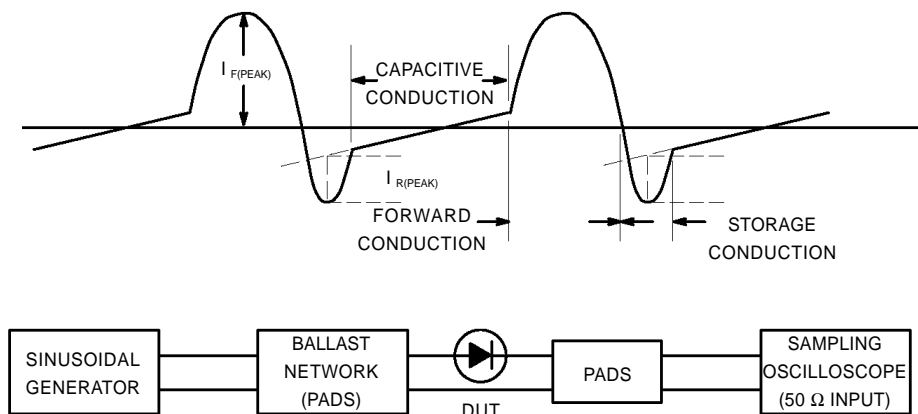

**Figure 5. Krakauer Method of Measuring Lifetime**

LMBD301LT1

**SOT-23**

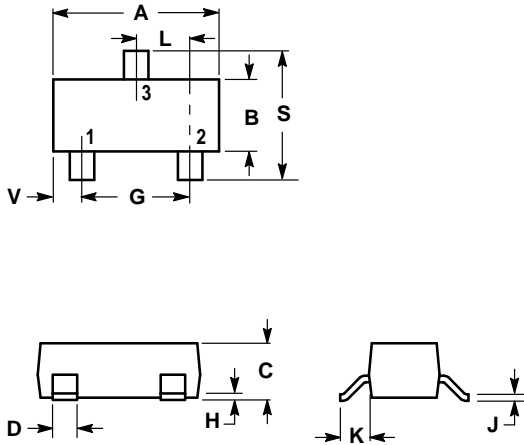

**NOTES:**

1. DIMENSIONING AND TOLERANCING PER ANSI Y14.5M, 1982.
2. CONTROLLING DIMENSION: INCH.

DIM	INCHES		MILLIMETERS	
	MIN	MAX	MIN	MAX
A	0.1102	0.1197	2.80	3.04
B	0.0472	0.0551	1.20	1.40
C	0.0350	0.0440	0.89	1.11
D	0.0150	0.0200	0.37	0.50
G	0.0701	0.0807	1.78	2.04
H	0.0005	0.0040	0.013	0.100
J	0.0034	0.0070	0.085	0.177
K	0.0140	0.0285	0.35	0.69
L	0.0350	0.0401	0.89	1.02
S	0.0830	0.1039	2.10	2.64
V	0.0177	0.0236	0.45	0.60

- PIN 1. ANODE  
 2. NO CONNECTION  
 3. CATHODE

