

Silicon Hot-Carrier Diodes

Schottky Barrier Diodes

LMBD301LT1G

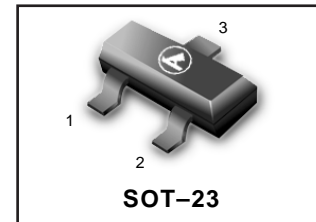

These devices are designed primarily for high-efficiency UHF and VHF detector applications. They are readily adaptable to many other fast switching RF and digital applications. They are supplied in an inexpensive plastic package for low-cost, high-volume consumer and industrial/commercial requirements. They are also available in a Surface Mount package.

- Extremely Low Minority Carrier Lifetime –15ps(Typ)
- Very Low Capacitance –1.5pF(Max)@ $V_R=15V$
- Low Reverse Leakage – $I_R=13$ nAdc(Typ) LMBD301
- We declare that the material of product compliance with RoHS requirements.

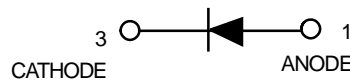

MAXIMUM RATINGS($T_J=125^\circ C$ unless otherwise noted)

Rating	symbol	value	unit
Reverse Voltage	V_R	30	Volts
Forward Power Dissipation	P_F	280	200
@ $T_A=25^\circ C$			mW
Derate above $25^\circ C$		2.8	2.0
			mW/ $^\circ C$
Operating Junction	T_J		$^\circ C$
Temperature Range		-55 to +125	
Storage Temperature Range	T_{stg}	-55 to +150	$^\circ C$

DEVICE MARKING

LMBD301LT1G= 4T

ELECTRICAL CHARACTERISTICS($T_A=25^\circ C$ unless otherwise noted)

Characteristic	Symbol	Min	Typ	Max	Unit
Reverse Breakdown Voltage($I_R=10\mu A$)	$V_{(BR)R}$	30	—	—	Volts
Total Capacitance($V_R=15V, f=1.0MHz$), Figure1	C_T	—	0.9	1.5	pF
Reverse Leakage($V_R=25V$) Figure3	I_R	—	13	200	nAdc
Forward Voltage($I_F=1.0mAdc$) Figure4	V_F	—	0.38	0.45	Vdc
Forward Voltage($I_F=10mAdc$) Figure4	V_F	—	0.52	0.6	Vdc

NOTE: LMBD301LT1G is also available in bulk packaging. Use **LMBD301LT1G** as the device title to order this device in bulk.

Ordering Information

Device	Marking	Shipping
LMBD301LT1G	4T	3000/Tape&Reel
LMBD301LT3G	4T	10000/Tape&Reel

LMBD301LT1G

TYPICAL ELECTRICAL CHARACTERISTICS

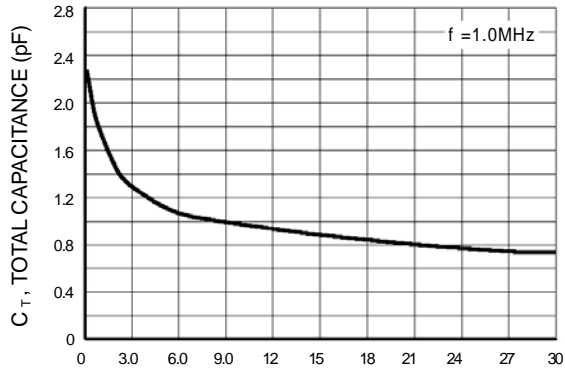

Figure 1. Total Capacitance

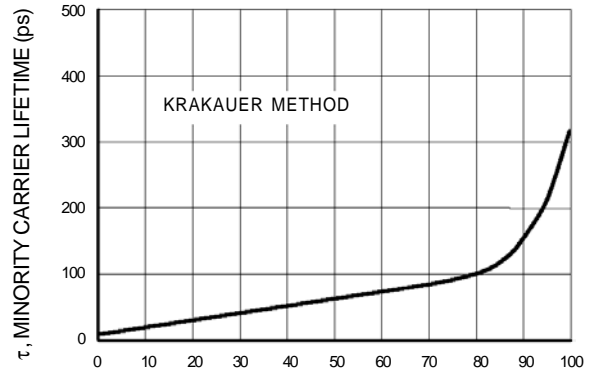

Figure 2. Minority Carrier Lifetime

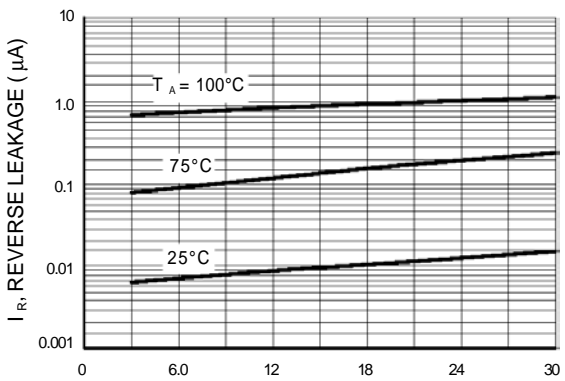

Figure 3. Reverse Leakage

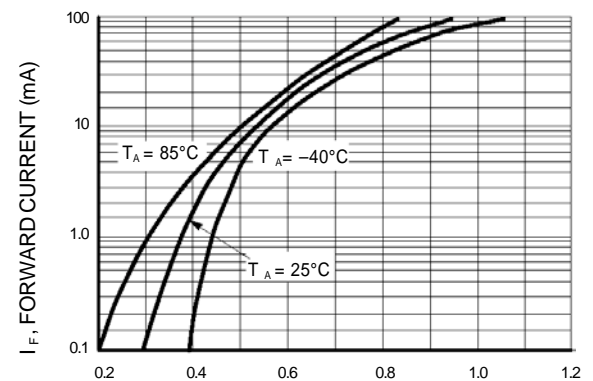

Figure 4. Forward Voltage

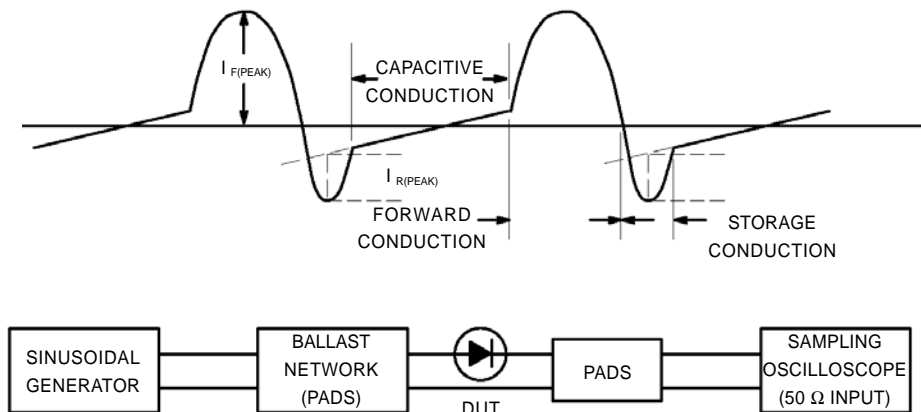
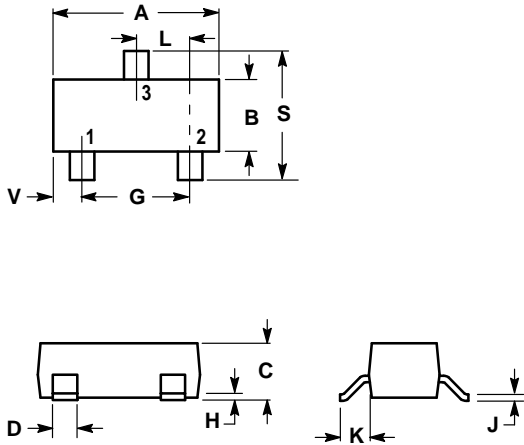

Figure 5. Krakauer Method of Measuring Lifetime

LMBD301LT1G

SOT-23



NOTES:

1. DIMENSIONING AND TOLERANCING PER ANSI Y14.5M, 1982.
2. CONTROLLING DIMENSION: INCH.

DIM	INCHES		MILLIMETERS	
	MIN	MAX	MIN	MAX
A	0.1102	0.1197	2.80	3.04
B	0.0472	0.0551	1.20	1.40
C	0.0350	0.0440	0.89	1.11
D	0.0150	0.0200	0.37	0.50
G	0.0701	0.0807	1.78	2.04
H	0.0005	0.0040	0.013	0.100
J	0.0034	0.0070	0.085	0.177
K	0.0140	0.0285	0.35	0.69
L	0.0350	0.0401	0.89	1.02
S	0.0830	0.1039	2.10	2.64
V	0.0177	0.0236	0.45	0.60

- PIN 1. ANODE
 2. NO CONNECTION
 3. CATHODE

