

General Purpose Transistors

PNP Silicon

FEATURE

- Simplifies Circuit Design.
- We declare that the material of product compliance with RoHS requirements.
- S- Prefix for Automotive and Other Applications Requiring Unique Site and Control Change Requirements; AEC-Q101 Qualified and PPAP Capable.

LMBT3906TT1G
S-LMBT3906TT1G

ORDERING INFORMATION

Device	Marking	Shipping
LMBT3906TT1G S-LMBT3906TT1G	2A 2A	3000/Tape & Reel
LMBT3906TT3G S-LMBT3906TT3G	2A 2A	10000/Tape & Reel

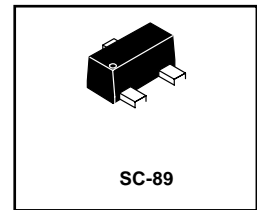

MAXIMUM RATINGS

Rating	Symbol	Value	Unit
Collector–Emitter Voltage	V_{CEO}	- 40	Vdc
Collector–Base Voltage	V_{CBO}	- 40	Vdc
Emitter–Base Voltage	V_{EBO}	- 5.0	Vdc
Collector Current — Continuous	I_C	- 200	mAdc

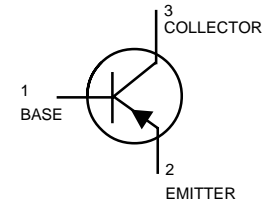

THERMAL CHARACTERISTICS

Characteristic	Symbol	Max	Unit
Total Device Dissipation FR-4 Board(1) $T_A = 25^\circ\text{C}$	P_D	200	mW
Derate above 25°C		1.6	mW/ $^\circ\text{C}$
Thermal Resistance Junction to Ambient	$R_{\theta JA}$	600	$^\circ\text{C}/\text{W}$
Total Device Dissipation FR-4 Board (2), $T_A = 25^\circ\text{C}$	P_D	300	mW
Derate above 25°C		2.4	mW/ $^\circ\text{C}$
Thermal Resistance Junction to Ambient	$R_{\theta JA}$	400	$^\circ\text{C}/\text{W}$
Junction and Storage Temperature	T_J, T_{stg}	-55 to +150	$^\circ\text{C}$

DEVICE MARKING

LMBT3906TT1G = 2A

ELECTRICAL CHARACTERISTICS ($T_A = 25^\circ\text{C}$ unless otherwise noted)

Characteristic	Symbol	Min	Max	Unit
----------------	--------	-----	-----	------

OFF CHARACTERISTICS

Collector–Emitter Breakdown Voltage (3) ($I_C = -1.0 \text{ mAdc}, I_B = 0$)	$V_{(BR)CEO}$	- 40	—	Vdc
Collector–Base Breakdown Voltage ($I_C = -10 \mu\text{Adc}, I_E = 0$)	$V_{(BR)CBO}$	- 40	—	Vdc
Emitter–Base Breakdown Voltage ($I_E = -10 \mu\text{Adc}, I_C = 0$)	$V_{(BR)EBO}$	- 5.0	—	Vdc
Base Cutoff Current ($V_{CE} = -30 \text{ Vdc}, V_{EB} = -3.0 \text{ Vdc}$)	I_{BL}	—	- 50	nAdc
Collector Cutoff Current ($V_{CE} = -30 \text{ Vdc}, V_{EB} = -3.0 \text{ Vdc}$)	I_{CEX}	—	- 50	nAdc

1. FR-4 Minimum Pad.
2. FR-4 1.0 x 1.0 Inch Pad.
3. Pulse Width $\leq 300 \mu\text{s}$; Duty Cycle $\leq 2.0\%$.

LMBT3906TT1G;S-LMBT3906TT1G
ELECTRICAL CHARACTERISTICS ($T_A = 25^\circ\text{C}$ unless otherwise noted) (Continued)

Characteristic	Symbol	Min	Max	Unit
ON CHARACTERISTICS (3)				
DC Current Gain ($I_C = -0.1 \text{ mA}$, $V_{CE} = -1.0 \text{ Vdc}$)	h_{FE}	60	—	—
($I_C = -1.0 \text{ mA}$, $V_{CE} = -1.0 \text{ Vdc}$)		80	—	
($I_C = -10 \text{ mA}$, $V_{CE} = -1.0 \text{ Vdc}$)		100	300	
($I_C = -50 \text{ mA}$, $V_{CE} = -1.0 \text{ Vdc}$)		60	—	
($I_C = -100 \text{ mA}$, $V_{CE} = -1.0 \text{ Vdc}$)		30	—	
Collector–Emitter Saturation Voltage ($I_C = -10 \text{ mA}$, $I_B = -1.0 \text{ mA}$)	$V_{CE(sat)}$	—	-0.25	Vdc
($I_C = -50 \text{ mA}$, $I_B = -5.0 \text{ mA}$)		—	-0.4	
Base–Emitter Saturation Voltage ($I_C = -10 \text{ mA}$, $I_B = -1.0 \text{ mA}$)	$V_{BE(sat)}$	-0.65	-0.85	Vdc
($I_C = -50 \text{ mA}$, $I_B = -5.0 \text{ mA}$)		—	-0.95	

SMALL-SIGNAL CHARACTERISTICS

Current–Gain — Bandwidth Product ($I_C = -10 \text{ mA}$, $V_{CE} = -20 \text{ Vdc}$, $f = 100 \text{ MHz}$)	f_T	250	—	MHz
Output Capacitance ($V_{CB} = -5.0 \text{ Vdc}$, $I_E = 0$, $f = 1.0 \text{ MHz}$)	C_{obo}	—	4.5	pF
Input Capacitance ($V_{EB} = -0.5 \text{ Vdc}$, $I_C = 0$, $f = 1.0 \text{ MHz}$)	C_{ibo}	—	10	pF
Input Impedance ($V_{CE} = -10 \text{ Vdc}$, $I_C = -1.0 \text{ mA}$, $f = 1.0 \text{ kHz}$)	h_{ie}	2.0	12	k Ω
Voltage Feedback Ratio ($V_{CE} = -10 \text{ Vdc}$, $I_C = -1.0 \text{ mA}$, $f = 1.0 \text{ kHz}$)	h_{re}	0.1	10	$\times 10^{-4}$
Small–Signal Current Gain ($V_{CE} = -10 \text{ Vdc}$, $I_C = -1.0 \text{ mA}$, $f = 1.0 \text{ kHz}$)	h_{fe}	100	400	—
Output Admittance ($V_{CE} = -10 \text{ Vdc}$, $I_C = -1.0 \text{ mA}$, $f = 1.0 \text{ kHz}$)	* h_{oe}	3.0	60	μmhos
Noise Figure ($V_{CE} = -5.0 \text{ Vdc}$, $I_C = -100 \mu\text{A}$, $R_S = 1.0 \text{ k}\Omega$, $f = 1.0 \text{ kHz}$)	NF	—	4.0	dB

SWITCHING CHARACTERISTICS

Delay Time	($V_{CC} = -3.0 \text{ Vdc}$, $V_{BE} = 0.5 \text{ Vdc}$, $I_C = -10 \text{ mA}$, $I_{B1} = -1.0 \text{ mA}$)	t_d	—	35	ns
Rise Time		t_d	—	35	
Storage Time	($V_{CC} = -3.0 \text{ Vdc}$, $I_C = -10 \text{ mA}$, $I_{B1} = I_{B2} = -1.0 \text{ mA}$)	t_s	—	225	ns
Fall Time		t_f	—	75	

 3. Pulse Test: Pulse Width $\leq 300 \mu\text{s}$; Duty Cycle $\leq 2.0\%$.

LMBT3906TT1G;S-LMBT3906TT1G

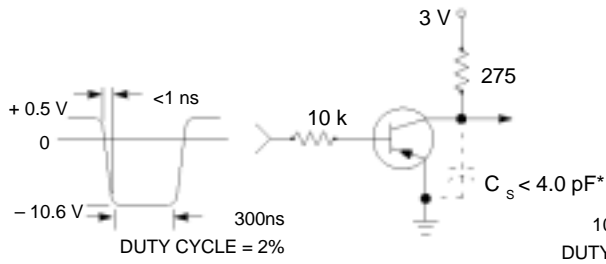

Figure 1. Delay and Rise Time
Equivalent Test Circuit

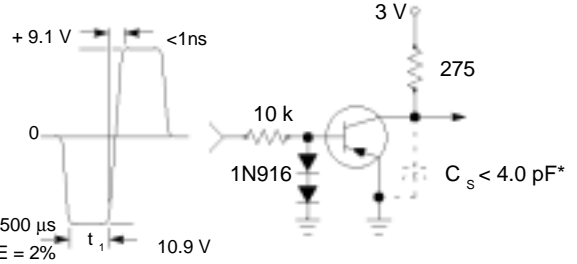

Figure 2. Storage and Fall Time
Equivalent Test Circuit

*Total shunt capacitance of test jig and connectors

TYPICAL TRANSIENT CHARACTERISTICS

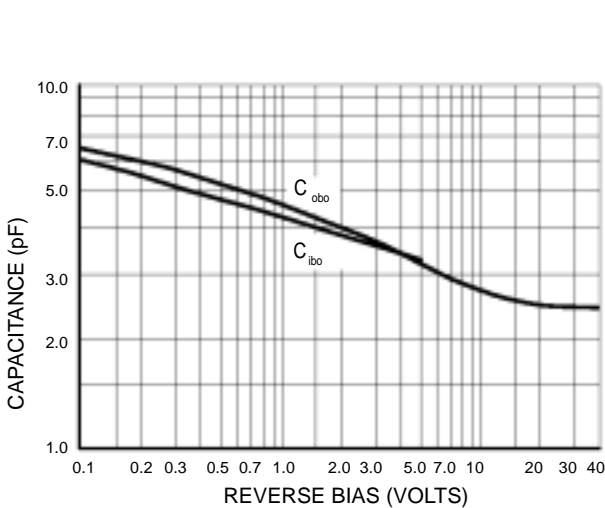

Figure 3. Capacitance

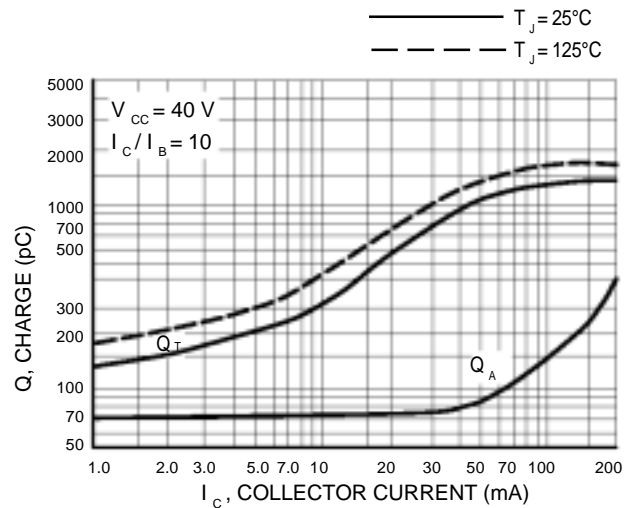

Figure 4. Charge Data

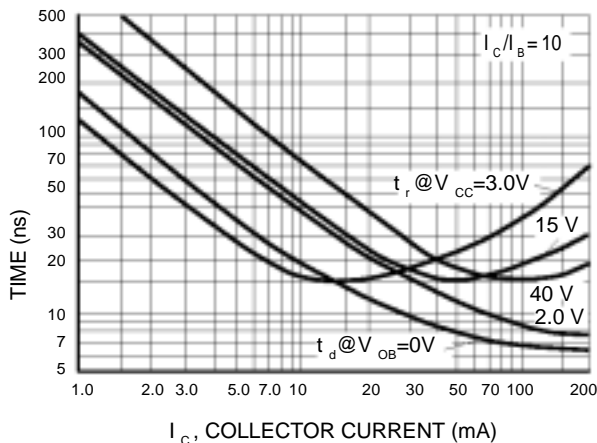

Figure 5. Turn-On Time

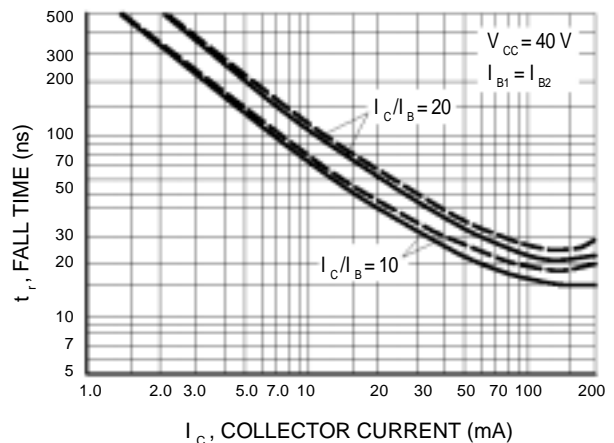

Figure 6. Fall Time

TYPICAL AUDIO SMALL-SIGNAL CHARACTERISTICS
NOISE FIGURE VARIATIONS

($V_{CE} = -5.0$ Vdc, $T_A = 25^\circ\text{C}$, Bandwidth = 1.0 Hz)

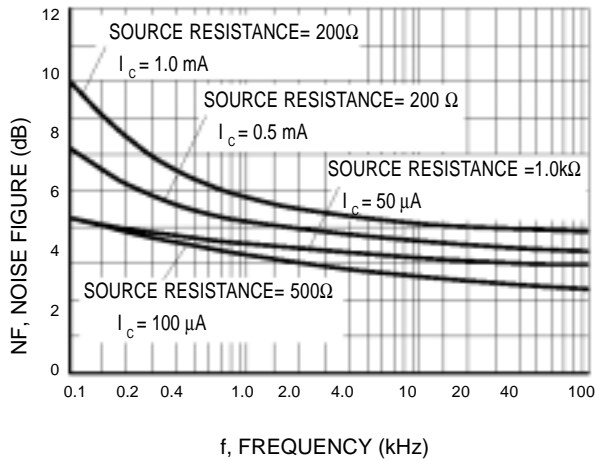

Figure 7. Noise Figure

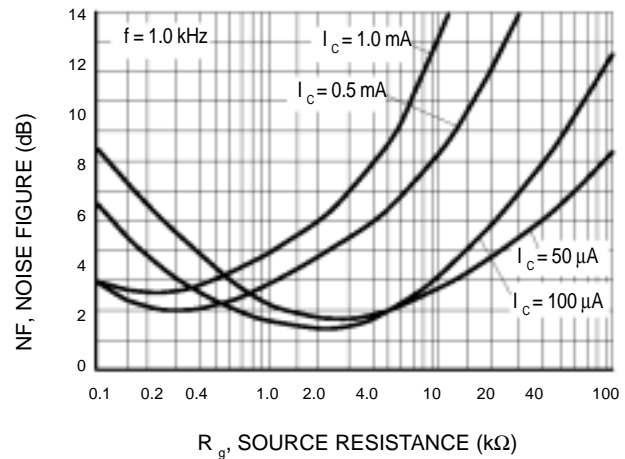

Figure 8. Noise Figure

h PARAMETERS

($V_{CE} = 10$ Vdc, $f = 1.0$ kHz, $T_A = 25^\circ\text{C}$)

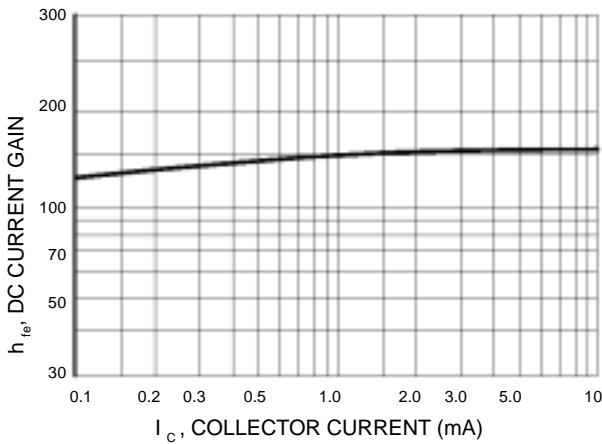

Figure 9. Current Gain

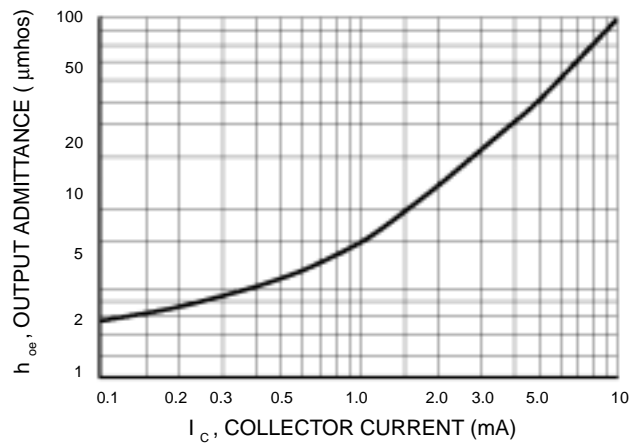

Figure 10. Output Admittance

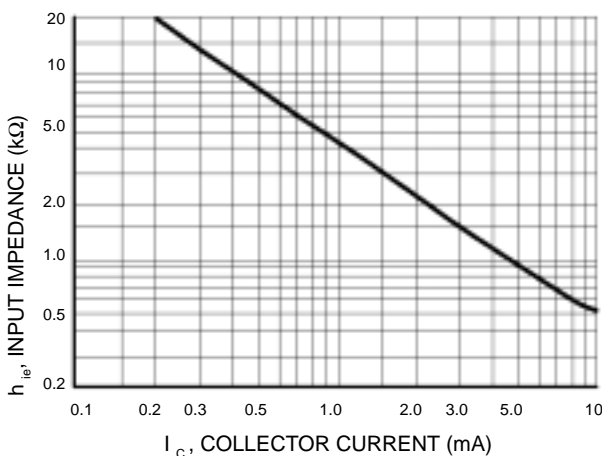

Figure 11. Input Impedance

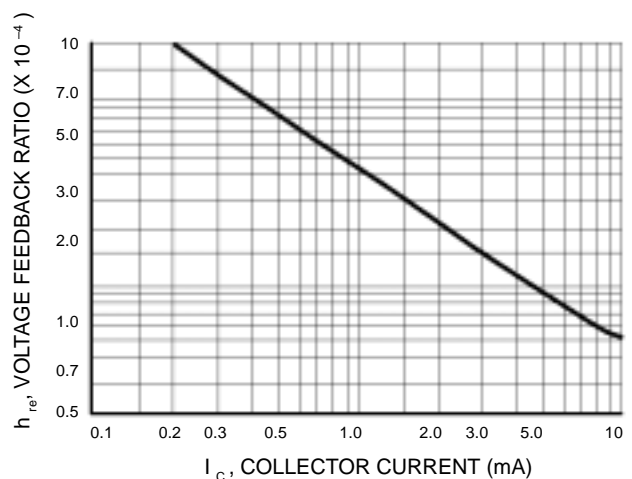

Figure 12. Voltage Feedback Ratio

TYPICAL STATIC CHARACTERISTICS

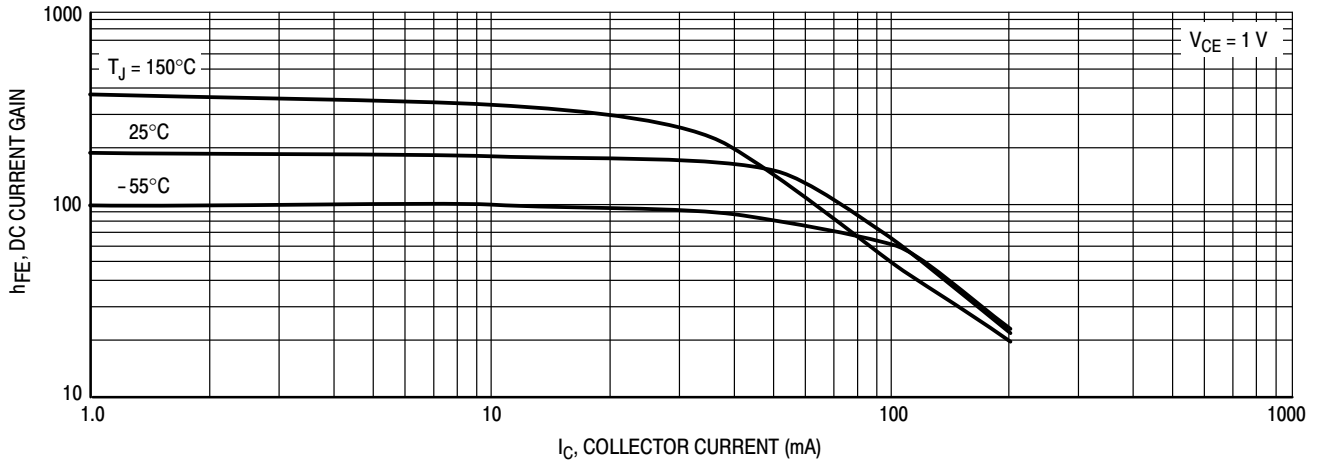

Figure 13. DC Current Gain

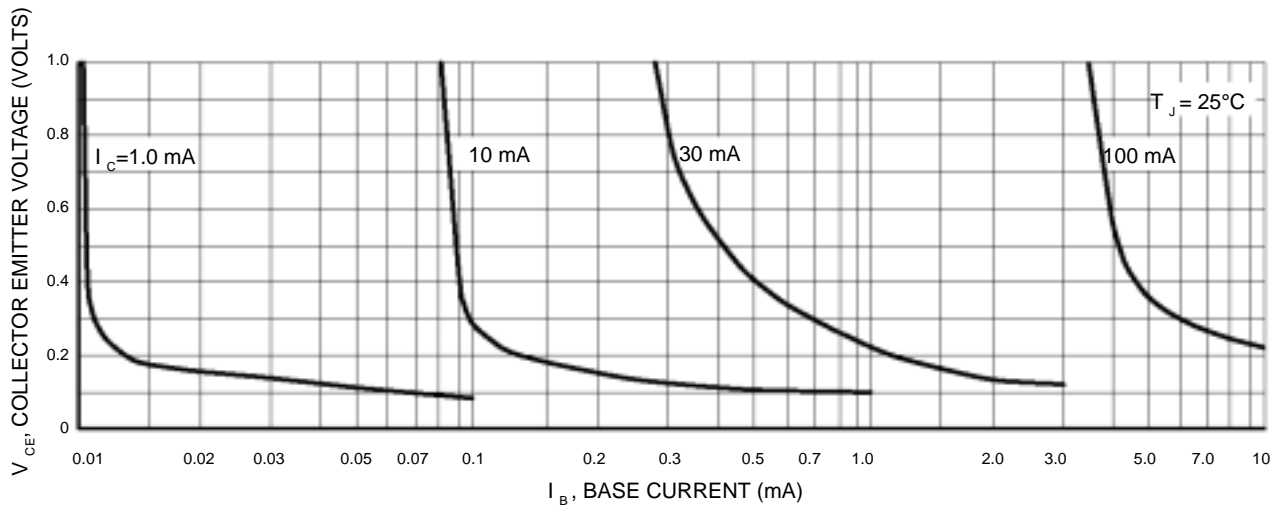

Figure 14. Collector Saturation Region

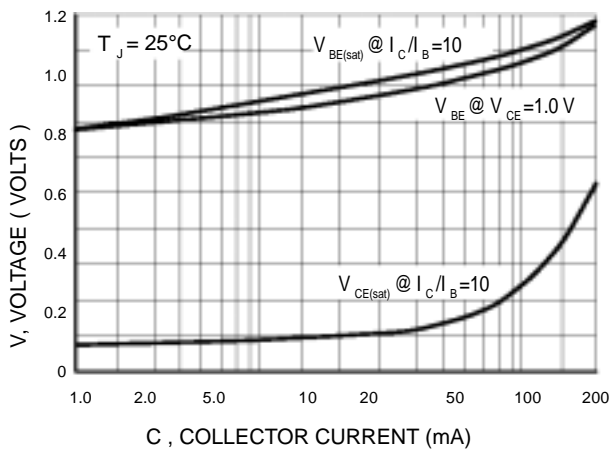

Figure 15. "ON" Voltages

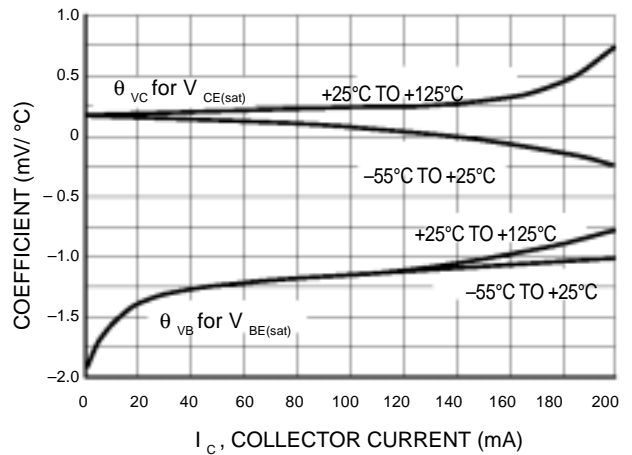
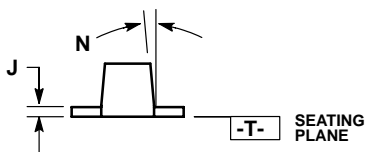
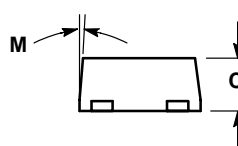
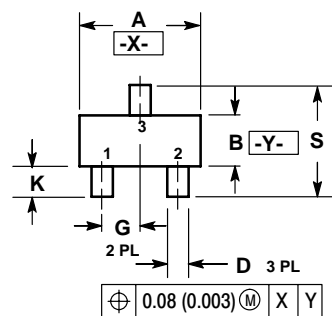

Figure 16. Temperature Coefficients

LMBT3906TT1G;S-LMBT3906TT1G

SC-89



NOTES:

1. DIMENSIONING AND TOLERANCING PER ANSI Y14.5M, 1982.
2. CONTROLLING DIMENSION: MILLIMETERS
3. MAXIMUM LEAD THICKNESS INCLUDES LEAD FINISH THICKNESS. MINIMUM LEAD THICKNESS IS THE MINIMUM THICKNESS OF BASE MATERIAL.
4. 463C-01 OBSOLETE, NEW STANDARD 463C-02.

DIM	MILLIMETERS			INCHES		
	MIN	NOM	MAX	MIN	NOM	MAX
A	1.50	1.60	1.70	0.059	0.063	0.067
B	0.75	0.85	0.95	0.030	0.034	0.040
C	0.60	0.70	0.80	0.024	0.028	0.031
D	0.23	0.28	0.33	0.009	0.011	0.013
G	0.50 BSC			0.020 BSC		
H	0.53 REF			0.021 REF		
J	0.10	0.15	0.20	0.004	0.006	0.008
K	0.30	0.40	0.50	0.012	0.016	0.020
L	1.10 REF			0.043 REF		
M	---	---	10 °	---	---	10 °
N	---	---	10 °	---	---	10 °
S	1.50	1.60	1.70	0.059	0.063	0.067

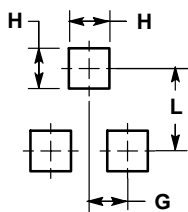

RECOMMENDED PATTERN OF SOLDER PADS