

# General Purpose Transistors

## PNP Silicon

### LMBT3906TT1

#### FEATURE

- Simplifies Circuit Design.
- This is a Pb-Free Device.

#### ORDERING INFORMATION

Device	Package	Shipping
LMBT3906TT1	SC-89	3000/Tape&Reel

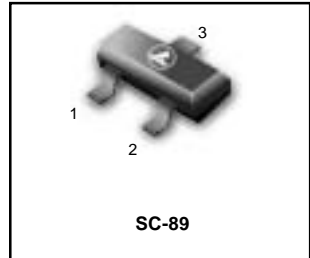

#### MAXIMUM RATINGS

Rating	Symbol	Value	Unit
Collector–Emitter Voltage	$V_{CEO}$	- 40	Vdc
Collector–Base Voltage	$V_{CBO}$	- 40	Vdc
Emitter–Base Voltage	$V_{EBO}$	- 5.0	Vdc
Collector Current — Continuous	$I_C$	- 200	mAdc

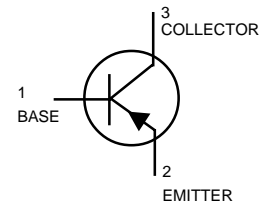

#### THERMAL CHARACTERISTICS

Characteristic	Symbol	Max	Unit
Total Device Dissipation FR-4 Board(1) $T_A = 25^\circ\text{C}$	$P_D$	200	mW
Derate above $25^\circ\text{C}$		1.6	mW/ $^\circ\text{C}$
Thermal Resistance Junction to Ambient	$R_{\theta JA}$	600	$^\circ\text{C}/\text{W}$
Total Device Dissipation FR-4 Board (2), $T_A = 25^\circ\text{C}$	$P_D$	300	mW
Derate above $25^\circ\text{C}$		2.4	mW/ $^\circ\text{C}$
Thermal Resistance Junction to Ambient	$R_{\theta JA}$	400	$^\circ\text{C}/\text{W}$
Junction and Storage Temperature	$T_J, T_{stg}$	-55 to +150	$^\circ\text{C}$

#### DEVICE MARKING

LMBT3906TT1 = 2A

#### ELECTRICAL CHARACTERISTICS ( $T_A = 25^\circ\text{C}$ unless otherwise noted)

Characteristic	Symbol	Min	Max	Unit
----------------	--------	-----	-----	------

#### OFF CHARACTERISTICS

Collector–Emitter Breakdown Voltage (3) ( $I_C = -1.0\text{ mAdc}, I_B = 0$ )	$V_{(BR)CEO}$	- 40	—	Vdc
Collector–Base Breakdown Voltage ( $I_C = -10\ \mu\text{Adc}, I_E = 0$ )	$V_{(BR)CBO}$	- 40	—	Vdc
Emitter–Base Breakdown Voltage ( $I_E = -10\ \mu\text{Adc}, I_C = 0$ )	$V_{(BR)EBO}$	- 5.0	—	Vdc
Base Cutoff Current ( $V_{CE} = -30\text{ Vdc}, V_{EB} = -3.0\text{ Vdc}$ )	$I_{BL}$	—	- 50	nAdc
Collector Cutoff Current ( $V_{CE} = -30\text{ Vdc}, V_{EB} = -3.0\text{ Vdc}$ )	$I_{CEX}$	—	- 50	nAdc

- FR-4 Minimum Pad.
- FR-4 1.0 x 1.0 Inch Pad.
- Pulse Width  $\leq 300\ \mu\text{s}$ ; Duty Cycle  $\leq 2.0\%$ .

**LMBT3906TT1**

**ELECTRICAL CHARACTERISTICS** ( $T_A = 25^\circ\text{C}$  unless otherwise noted) (Continued)

Characteristic	Symbol	Min	Max	Unit
<b>ON CHARACTERISTICS (3)</b>				
DC Current Gain ( $I_C = -0.1 \text{ mAdc}$ , $V_{CE} = -1.0 \text{ Vdc}$ )	$h_{FE}$	60	—	—
( $I_C = -1.0 \text{ mAdc}$ , $V_{CE} = -1.0 \text{ Vdc}$ )		80	—	
( $I_C = -10 \text{ mAdc}$ , $V_{CE} = -1.0 \text{ Vdc}$ )		100	300	
( $I_C = -50 \text{ mAdc}$ , $V_{CE} = -1.0 \text{ Vdc}$ )		60	—	
( $I_C = -100 \text{ mAdc}$ , $V_{CE} = -1.0 \text{ Vdc}$ )		30	—	
Collector-Emitter Saturation Voltage ( $I_C = -10 \text{ mAdc}$ , $I_B = -1.0 \text{ mAdc}$ )	$V_{CE(sat)}$	—	-0.25	Vdc
( $I_C = -50 \text{ mAdc}$ , $I_B = -5.0 \text{ mAdc}$ )		—	-0.4	
Base-Emitter Saturation Voltage ( $I_C = -10 \text{ mAdc}$ , $I_B = -1.0 \text{ mAdc}$ )	$V_{BE(sat)}$	-0.65	-0.85	Vdc
( $I_C = -50 \text{ mAdc}$ , $I_B = -5.0 \text{ mAdc}$ )		—	-0.95	

**SMALL-SIGNAL CHARACTERISTICS**

Current-Gain — Bandwidth Product ( $I_C = -10 \text{ mAdc}$ , $V_{CE} = -20 \text{ Vdc}$ , $f = 100 \text{ MHz}$ )	$f_T$	250	—	MHz
Output Capacitance ( $V_{CB} = -5.0 \text{ Vdc}$ , $I_E = 0$ , $f = 1.0 \text{ MHz}$ )	$C_{obo}$	—	4.5	pF
Input Capacitance ( $V_{EB} = -0.5 \text{ Vdc}$ , $I_C = 0$ , $f = 1.0 \text{ MHz}$ )	$C_{ibo}$	—	10	pF
Input Impedance ( $V_{CE} = -10 \text{ Vdc}$ , $I_C = -1.0 \text{ mAdc}$ , $f = 1.0 \text{ kHz}$ )	$h_{ie}$	2.0	12	k $\Omega$
Voltage Feedback Ratio ( $V_{CE} = -10 \text{ Vdc}$ , $I_C = -1.0 \text{ mAdc}$ , $f = 1.0 \text{ kHz}$ )	$h_{re}$	0.1	10	$\times 10^{-4}$
Small-Signal Current Gain ( $V_{CE} = -10 \text{ Vdc}$ , $I_C = -1.0 \text{ mAdc}$ , $f = 1.0 \text{ kHz}$ )	$h_{fe}$	100	400	—
Output Admittance ( $V_{CE} = -10 \text{ Vdc}$ , $I_C = -1.0 \text{ mAdc}$ , $f = 1.0 \text{ kHz}$ )	* $h_{oe}$	3.0	60	$\mu\text{mhos}$
Noise Figure ( $V_{CE} = -5.0 \text{ Vdc}$ , $I_C = -100 \mu\text{Adc}$ , $R_S = 1.0 \text{ k}\Omega$ , $f = 1.0 \text{ kHz}$ )	NF	—	4.0	dB

**SWITCHING CHARACTERISTICS**

Delay Time	( $V_{CC} = -3.0 \text{ Vdc}$ , $V_{BE} = 0.5 \text{ Vdc}$ , $I_C = -10 \text{ mAdc}$ , $I_{B1} = -1.0 \text{ mAdc}$ )	$t_d$	—	35	ns
Rise Time		$t_r$	—	35	
Storage Time	( $V_{CC} = -3.0 \text{ Vdc}$ , $I_C = -10 \text{ mAdc}$ , $I_{B1} = I_{B2} = -1.0 \text{ mAdc}$ )	$t_s$	—	225	ns
Fall Time		$t_f$	—	75	

3. Pulse Test: Pulse Width  $\leq 300 \mu\text{s}$ ; Duty Cycle  $\leq 2.0\%$ .

**LMBT3906TT1**

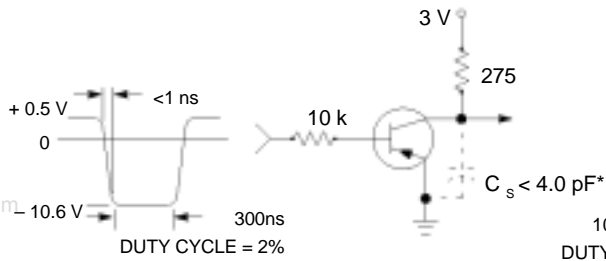

**Figure 1. Delay and Rise Time Equivalent Test Circuit**

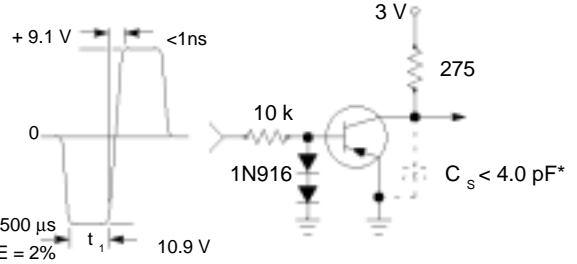

**Figure 2. Storage and Fall Time Equivalent Test Circuit**

\*Total shunt capacitance of test jig and connectors

**TYPICAL TRANSIENT CHARACTERISTICS**

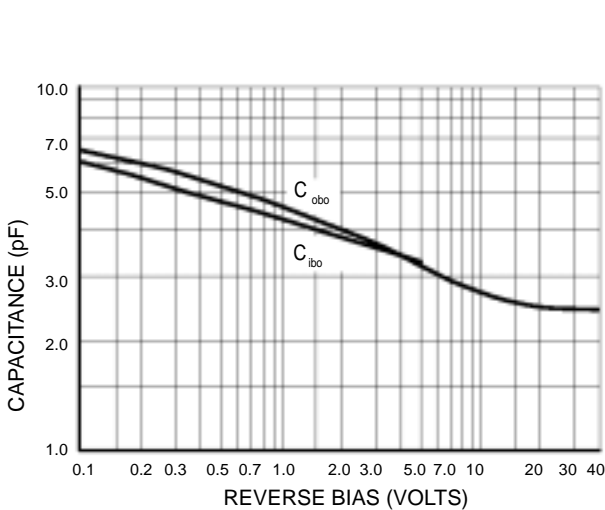

**Figure 3. Capacitance**

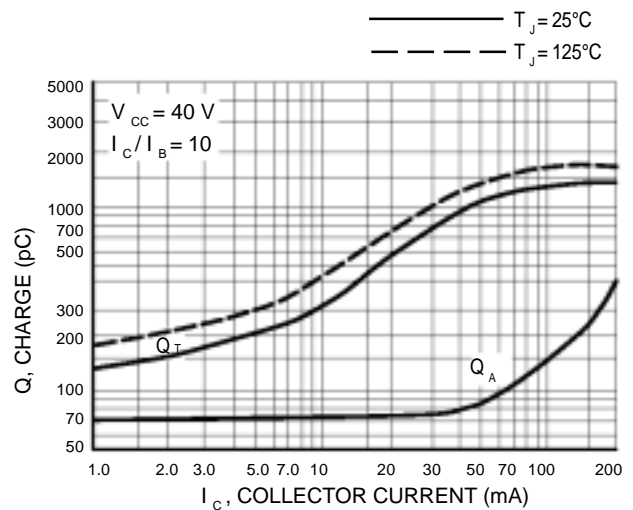

**Figure 4. Charge Data**

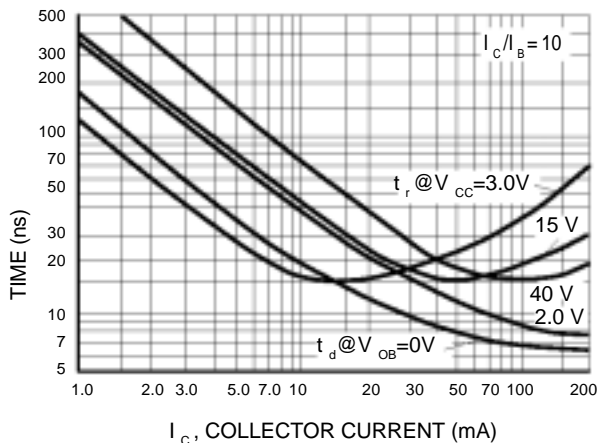

**Figure 5. Turn-On Time**

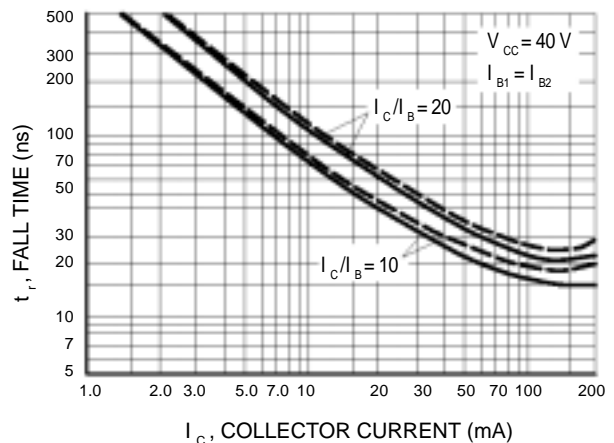
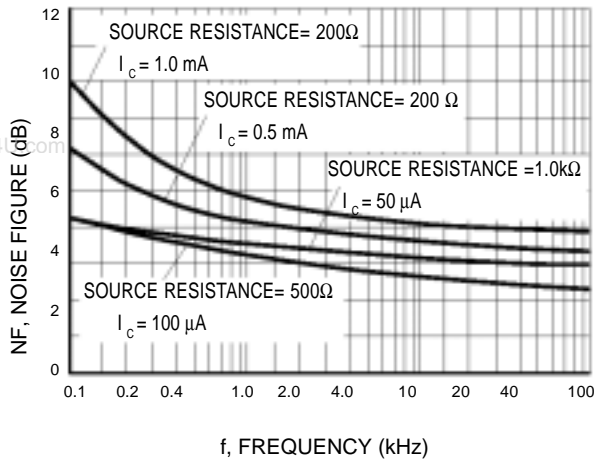

**Figure 6. Fall Time**

**LMBT3906TT1**

**TYPICAL AUDIO SMALL-SIGNAL CHARACTERISTICS  
NOISE FIGURE VARIATIONS**

( $V_{CE} = -5.0$  Vdc,  $T_A = 25^\circ\text{C}$ , Bandwidth = 1.0 Hz)



**Figure 7. Noise Figure**

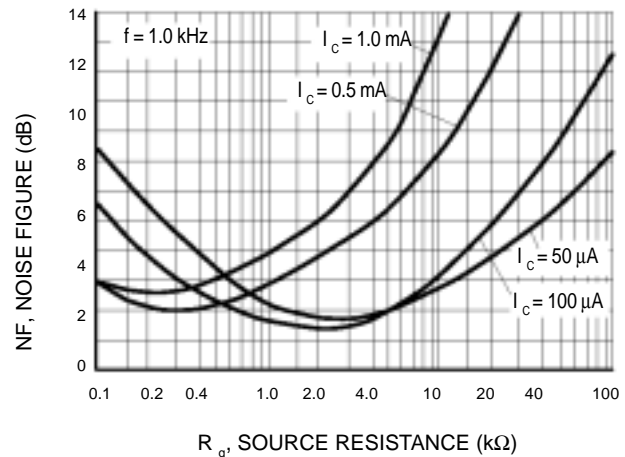

**Figure 8. Noise Figure**

**h PARAMETERS**

( $V_{CE} = 10$  Vdc,  $f = 1.0$  kHz,  $T_A = 25^\circ\text{C}$ )

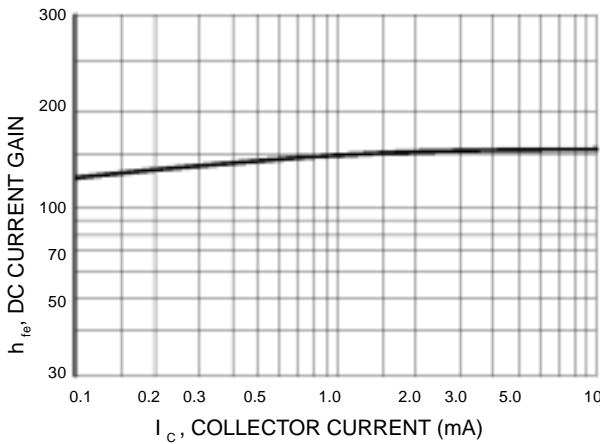

**Figure 9. Current Gain**

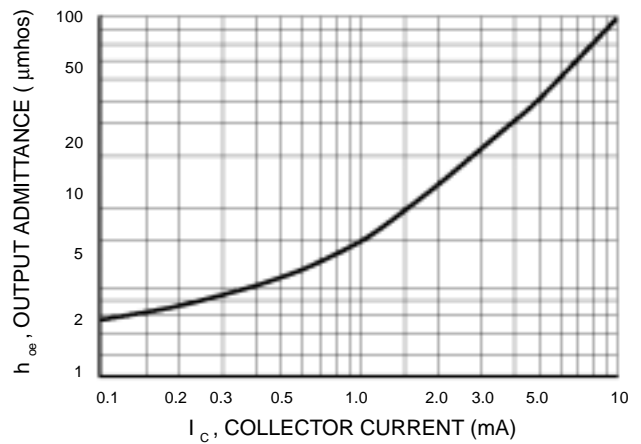

**Figure 10. Output Admittance**

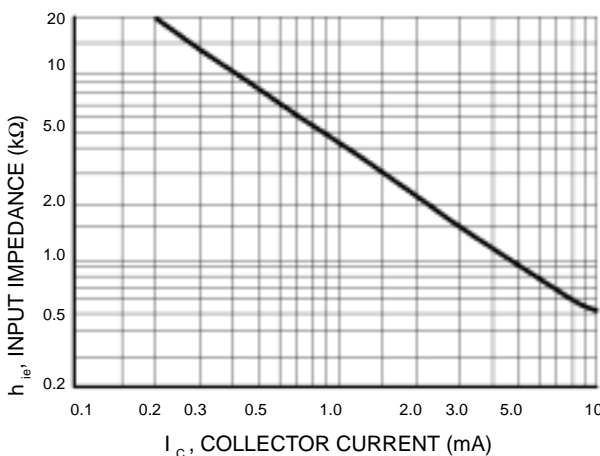

**Figure 11. Input Impedance**

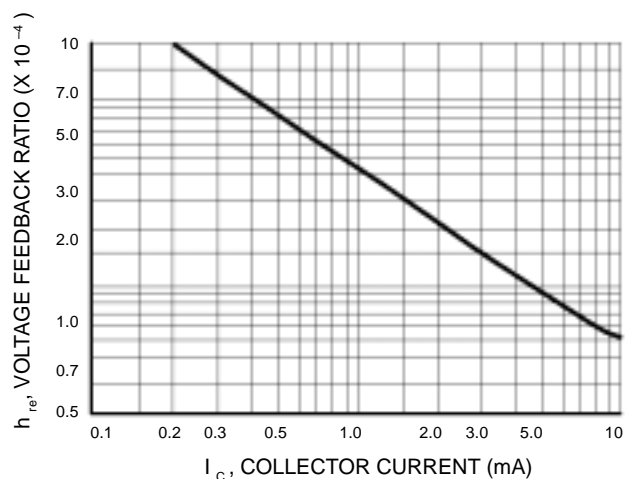

**Figure 12. Voltage Feedback Ratio**

**LMBT3906TT1**

**TYPICAL STATIC CHARACTERISTICS**

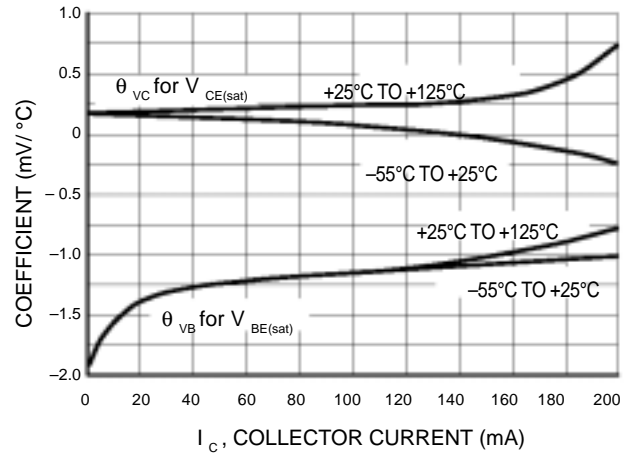
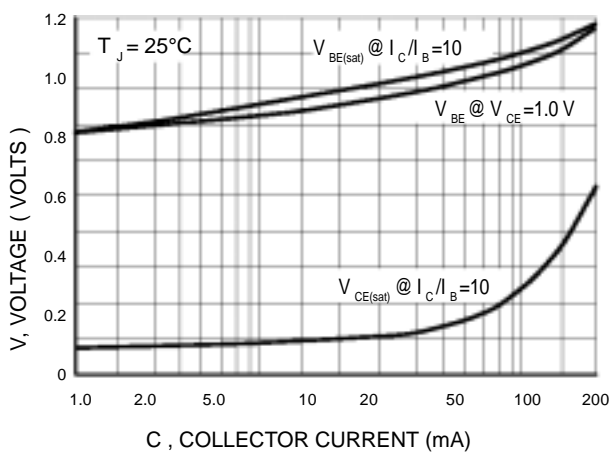
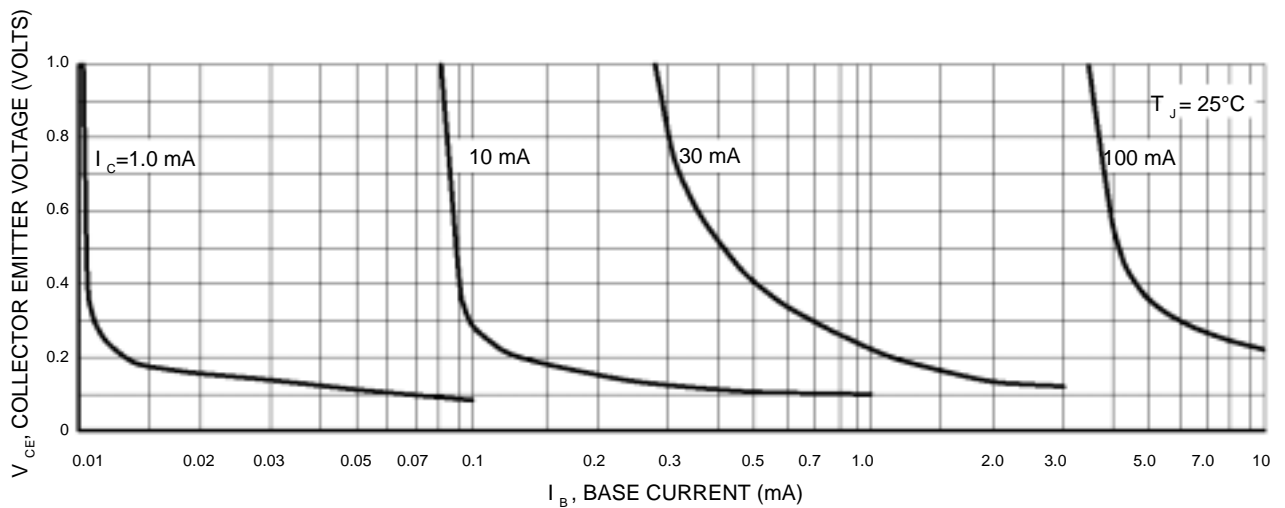
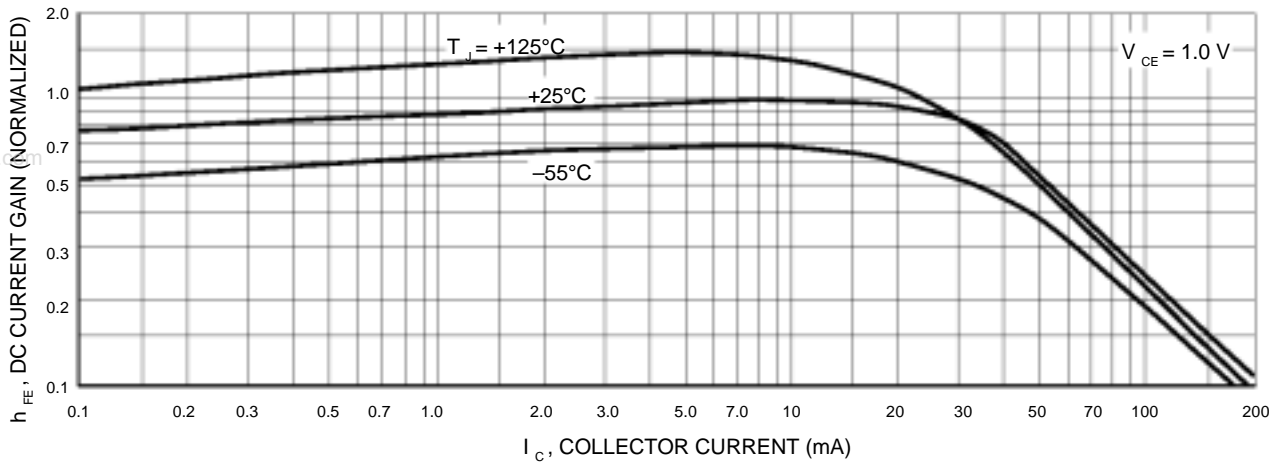

**LMBT3906TT1**

SC-89

www.DataSheet4U.com

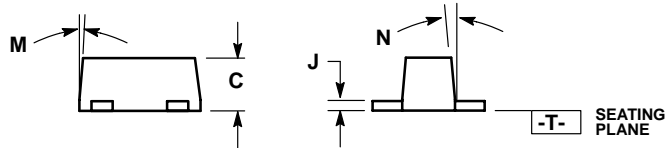
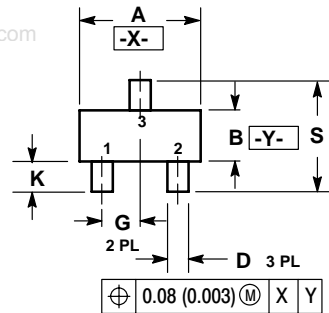

NOTES:

1. DIMENSIONING AND TOLERANCING PER ANSI Y14.5M, 1982.
2. CONTROLLING DIMENSION: MILLIMETERS
3. MAXIMUM LEAD THICKNESS INCLUDES LEAD FINISH THICKNESS. MINIMUM LEAD THICKNESS IS THE MINIMUM THICKNESS OF BASE MATERIAL.
4. 463C-01 OBSOLETE, NEW STANDARD 463C-02.

DIM	MILLIMETERS			INCHES		
	MIN	NOM	MAX	MIN	NOM	MAX
A	1.50	1.60	1.70	0.059	0.063	0.067
B	0.75	0.85	0.95	0.030	0.034	0.040
C	0.60	0.70	0.80	0.024	0.028	0.031
D	0.23	0.28	0.33	0.009	0.011	0.013
G	0.50 BSC			0.020 BSC		
H	0.53 REF			0.021 REF		
J	0.10	0.15	0.20	0.004	0.006	0.008
K	0.30	0.40	0.50	0.012	0.016	0.020
L	1.10 REF			0.043 REF		
M	---	---	10 °	---	---	10 °
N	---	---	10 °	---	---	10 °
S	1.50	1.60	1.70	0.059	0.063	0.067

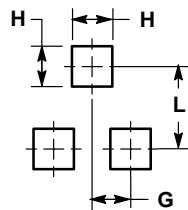

RECOMMENDED PATTERN OF SOLDER PADS