

## VHF/UHF Transistors

- We declare that the material of product compliance with RoHS requirements.
- S- Prefix for Automotive and Other Applications Requiring Unique Site and Control Change Requirements; AEC-Q101 Qualified and PPAP Capable.

### Ordering Information

Device	Marking	Shipping
LMBTH10QLT1G S-LMBTH10QLT1G	3EQ	3000/Tape&Reel
LMBTH10QLT3G S-LMBTH10QLT3G	3EQ	10000/Tape&Reel

### MAXIMUM RATINGS

Rating	Symbol	Value	Unit
Collector–Emitter Voltage	$V_{CEO}$	25	Vdc
Collector–Base Voltage	$V_{CBO}$	30	Vdc
Emitter–Base Voltage	$V_{EBO}$	3.0	Vdc

### THERMAL CHARACTERISTICS

Characteristic	Symbol	Max	Unit
Total Device Dissipation FR– 5 Board, (1) $T_A = 25^\circ\text{C}$	$P_D$	225	mW
Derate above $25^\circ\text{C}$		1.8	mW/ $^\circ\text{C}$
Thermal Resistance, Junction to Ambient	$R_{\theta JA}$	556	$^\circ\text{C}/\text{W}$
Total Device Dissipation Alumina Substrate, (2) $T_A = 25^\circ\text{C}$	$P_D$	300	mW
Derate above $25^\circ\text{C}$		2.4	mW/ $^\circ\text{C}$
Thermal Resistance, Junction to Ambient	$R_{\theta JA}$	417	$^\circ\text{C}/\text{W}$
Junction and Storage Temperature	$T_J, T_{stg}$	-55 to +150	$^\circ\text{C}$

### DEVICE MARKING

(S-)LMBTH10LT1G = 3EQ

### ELECTRICAL CHARACTERISTICS ( $T_A = 25^\circ\text{C}$ unless otherwise noted.)

Characteristic	Symbol	Min	Typ	Max	Unit
----------------	--------	-----	-----	-----	------

### OFF CHARACTERISTICS

Collector–Emitter Breakdown Voltage ( $I_C = 1.0 \text{ mAdc}, I_E = 0$ )	$V_{(BR)CEO}$	25	—	—	Vdc
Collector–Base Breakdown Voltage ( $I_C = 100 \mu\text{Adc}, I_E = 0$ )	$V_{(BR)CBO}$	30	—	—	Vdc
Emitter–Base Breakdown Voltage ( $I_E = 10 \mu\text{Adc}, I_C = 0$ )	$V_{(BR)EBO}$	3.0	—	—	Vdc
Collector Cutoff Current ( $V_{CB} = 25\text{Vdc}, I_E = 0$ )	$I_{CBO}$	—	—	100	nAdc
Collector Cutoff Current ( $V_{CB} = 30\text{Vdc}, I_E = 0$ )	$I_{CBO}$	—	—	100	uAdc
Emitter Cutoff Current ( $V_{EB} = 2.0\text{Vdc}, I_C = 0$ )	$I_{EBO}$	—	—	100	nAdc
Emitter Cutoff Current ( $V_{EB} = 3.0\text{Vdc}, I_C = 0$ )	$I_{EBO}$	—	—	10	uAdc

1. FR–5 = 1.0 x 0.75 x 0.062 in.

2. Alumina = 0.4 x 0.3 x 0.024 in. 99.5% alumina.

## LMBTH10QLT1G S-LMBTH10QLT1G

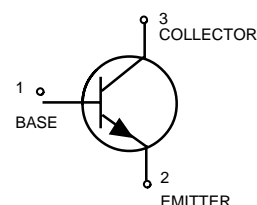
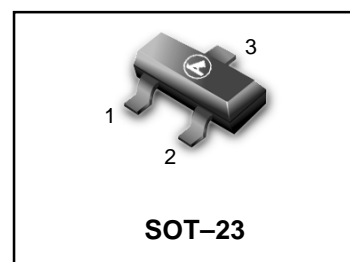

LMBTH10QLT1G , S-LMBTH10QLT1G

**ELECTRICAL CHARACTERISTICS** ( $T_A = 25^\circ\text{C}$  unless otherwise noted) (Continued)

Characteristic	Symbol	Min	Typ	Max	Unit
----------------	--------	-----	-----	-----	------

**DC CHARACTERISTICS**

DC Current Gain ( $I_C = 4.0 \text{ mA}$ , $V_{CE} = 10 \text{ Vdc}$ )	$h_{FE}$	120	—	—	—
Collector–Emitter Saturation Voltage ( $I_C = 4.0 \text{ mA}$ , $I_B = 0.4 \text{ mA}$ )	$V_{CE(sat)}$	—	—	0.5	Vdc
Base–Emitter On Voltage ( $I_C = 4.0 \text{ mA}$ , $V_{CE} = 10 \text{ Vdc}$ )	$V_{BE}$	—	—	0.95	Vdc

**SMALL–SIGNAL CHARACTERISTICS**

Current Gain–Bandwidth Product ( $V_{CE} = 10 \text{ Vdc}$ , $I_C = 4.0 \text{ mA}$ , $f = 100 \text{ MHz}$ )	$f_T$	650	—	—	MHz
Collector –Base Capacitance ( $V_{CB} = 10 \text{ Vdc}$ , $I_E = 0$ , $f = 1.0 \text{ MHz}$ )	$C_{cb}$	—	—	0.7	pF
Collector –Base Feedback Capacitance ( $V_{CB} = 10 \text{ Vdc}$ , $I_E = 0$ , $f = 1.0 \text{ MHz}$ )	$C_{fb}$	—	—	0.65	pF
Collector Base Time Constant ( $I_C = 4.0 \text{ mA}$ , $V_{CB} = 10 \text{ Vdc}$ , $f = 31.8 \text{ MHz}$ )	$\tau_{bc}$	—	—	9.0	ps

LMBTH10QLT1G , S-LMBTH10QLT1G

TYPICAL CHARACTERISTICS

COMMON-BASE y PARAMETERS versus FREQUENCY

( $V_{CB} = 10 \text{ Vdc}$ ,  $I_C = 4.0 \text{ mAdc}$ ,  $T_A = 25^\circ\text{C}$ )

$y_{ib}$ , INPUT ADMITTANCE

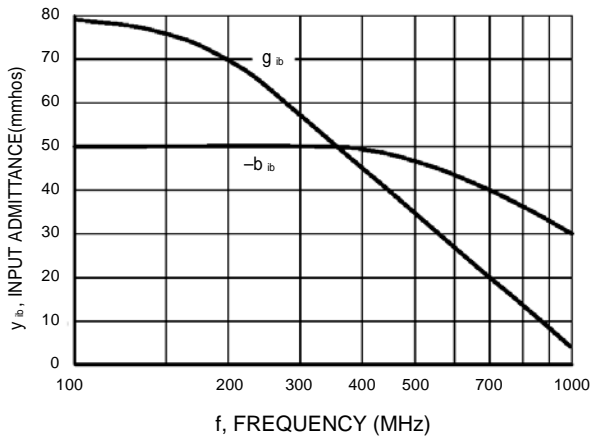

Figure 1. Rectangular Form

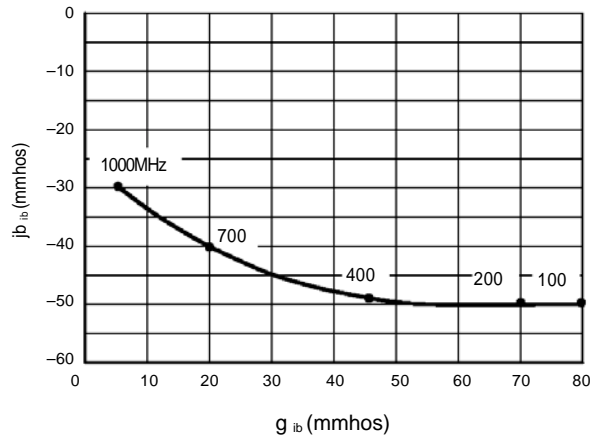

Figure 2. Polar Form

$y_{fb}$ , FORWARD TRANSFER ADMITTANCE

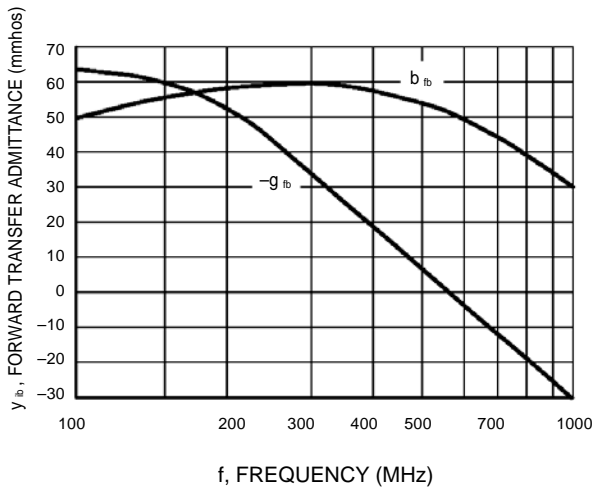

Figure 3. Rectangular Form

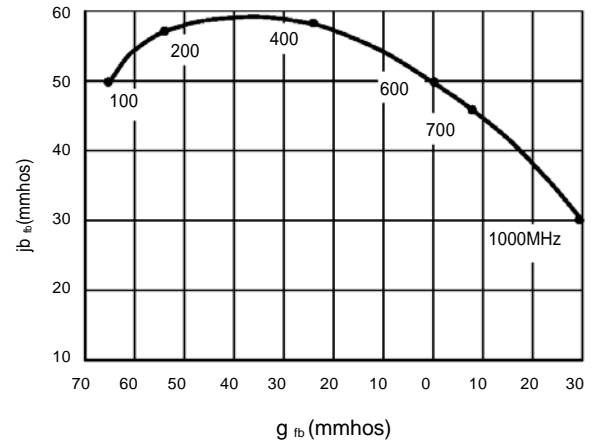

Figure 4. Polar Form

LMBTH10QLT1G , S-LMBTH10QLT1G

TYPICAL CHARACTERISTICS

COMMON-BASE  $y$  PARAMETERS versus FREQUENCY

( $V_{CB} = 10$  Vdc,  $I_C = 4.0$  mAdc,  $T_A = 25^\circ\text{C}$ )

$y_{rb}$ , REVERSE TRANSFER ADMITTANCE

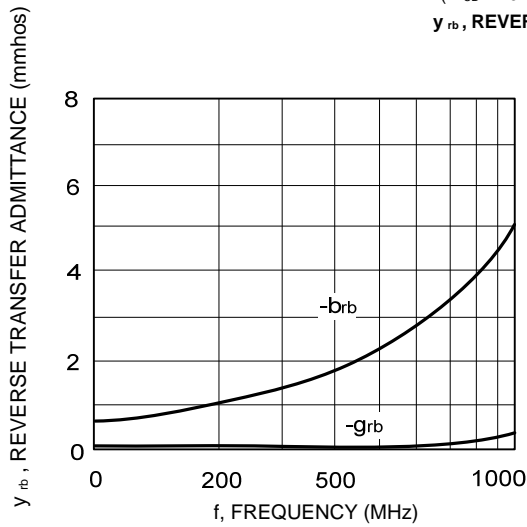

Figure 5. Rectangular Form

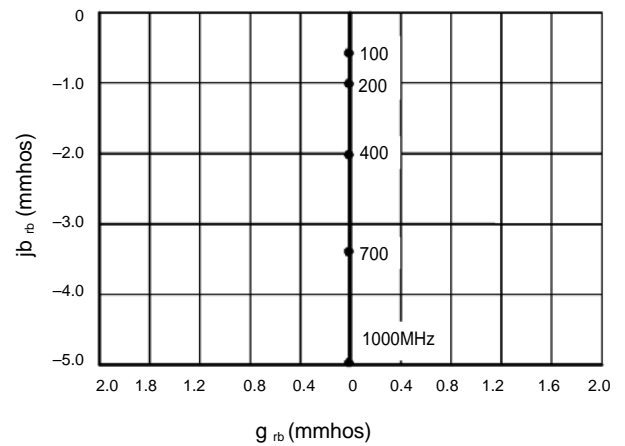

Figure 6. Polar Form

$y_{ob}$ , OUTPUT ADMITTANCE

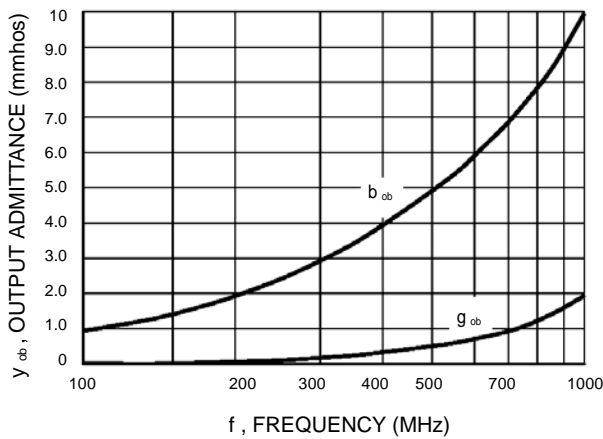

Figure 7. Rectangular Form

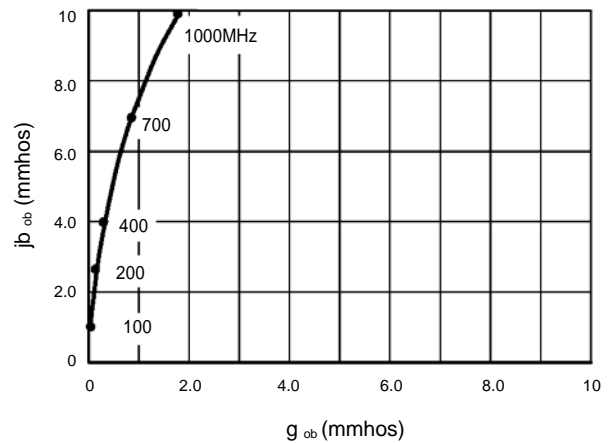
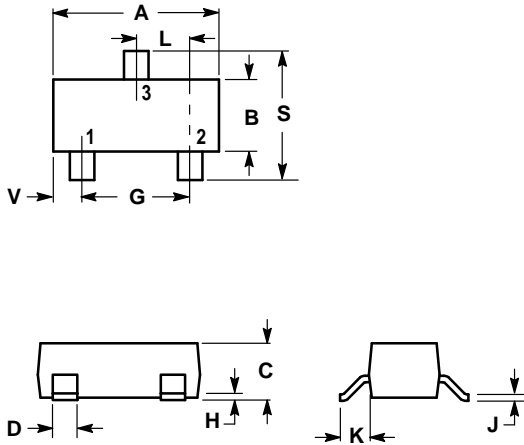

Figure 8. Polar Form

LMBTH10QLT1G , S-LMBTH10QLT1G

SOT-23



NOTES:

1. DIMENSIONING AND TOLERANCING PER ANSI Y14.5M, 1982.
2. CONTROLLING DIMENSION: INCH.

DIM	INCHES		MILLIMETERS	
	MIN	MAX	MIN	MAX
A	0.1102	0.1197	2.80	3.04
B	0.0472	0.0551	1.20	1.40
C	0.0350	0.0440	0.89	1.11
D	0.0150	0.0200	0.37	0.50
G	0.0701	0.0807	1.78	2.04
H	0.0005	0.0040	0.013	0.100
J	0.0034	0.0070	0.085	0.177
K	0.0140	0.0285	0.35	0.69
L	0.0350	0.0401	0.89	1.02
S	0.0830	0.1039	2.10	2.64
V	0.0177	0.0236	0.45	0.60

- PIN 1. BASE  
 2. EMITTER  
 3. COLLECTOR

