

VHF/UHF Transistors

Features

- We declare that the material of product compliance with RoHS requirements.
- S- Prefix for Automotive and Other Applications Requiring Unique Site and Control Change Requirements; AEC-Q101 Qualified and PPAP Capable.

LMBTH10WT1G
S-LMBTH10WT1G

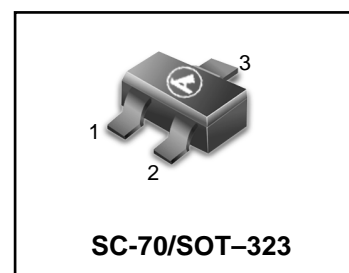

ORDERING INFORMATION

Device	Marking	Shipping
LMBTH10WT1G S-LMBTH10WT1G	3E	3000/Tape&Reel
LMBTH10WT3G S-LMBTH10WT3G	3E	10000/Tape&Reel

MAXIMUM RATINGS

Rating	Symbol	Value	Unit
Collector–Emitter Voltage	V_{CEO}	25	Vdc
Collector–Base Voltage	V_{CBO}	30	Vdc
Emitter–Base Voltage	V_{EBO}	3.0	Vdc
Collector Current	I_C	50	mA

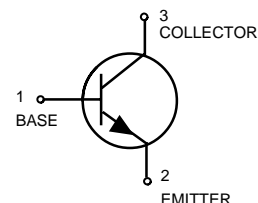

THERMAL CHARACTERISTICS

Characteristic	Symbol	Max	Unit
Total Device Dissipation FR- 5 Board (1) $T_A = 25^\circ\text{C}$ Derate above 25°C	P_D	150	mW
Thermal Resistance, Junction to Ambient	$R_{\theta JA}$	833	$^\circ\text{C/W}$
Total Device Dissipation Alumina Substrate, (2) $T_A = 25^\circ\text{C}$ Derate above 25°C	P_D	200	mW
Thermal Resistance, Junction to Ambient	$R_{\theta JA}$	625	$^\circ\text{C/W}$
Junction and Storage Temperature	T_J, T_{stg}	-55to+150	$^\circ\text{C}$

1. FR-5 = 1.0 x 0.75 x 0.062 in.

2. Alumina = 0.4 x 0.3 x 0.024 in. 99.5% alumina.

ELECTRICAL CHARACTERISTICS ($T_A = 25^\circ\text{C}$ unless otherwise noted.)

Characteristic	Symbol	Min	Typ	Max	Unit
----------------	--------	-----	-----	-----	------

OFF CHARACTERISTICS

Collector–Emitter Breakdown Voltage ($I_C = 1.0\text{ mAdc}, I_E = 0$)	$V_{(BR)CEO}$	25	—	—	Vdc
Collector–Base Breakdown Voltage ($I_C = 100\ \mu\text{Adc}, I_E = 0$)	$V_{(BR)CBO}$	30	—	—	Vdc
Emitter–Base Breakdown Voltage ($I_E = 10\ \mu\text{Adc}, I_C = 0$)	$V_{(BR)EBO}$	3.0	—	—	Vdc
Collector Cutoff Current ($V_{CB} = 25\text{Vdc}, I_E = 0$)	I_{CBO}	—	—	100	nAdc
Emitter Cutoff Current ($V_{EB} = 2.0\text{Vdc}, I_C = 0$)	I_{EBO}	—	—	100	nAdc

LMBTH10WT1G , S-LMBTH10WT1G

ELECTRICAL CHARACTERISTICS ($T_A = 25^\circ\text{C}$ unless otherwise noted) (Continued)

Characteristic	Symbol	Min	Typ	Max	Unit
DC CHARACTERISTICS					
DC Current Gain ($I_C = 4.0\text{ mA}$, $V_{CE} = 10\text{ Vdc}$)	h_{FE}	60	—	270	—
Collector–Emitter Saturation Voltage ($I_C = 4.0\text{ mA}$, $I_B = 0.4\text{ mA}$)	$V_{CE(sat)}$	—	—	0.5	Vdc
Base–Emitter On Voltage ($I_C = 4.0\text{ mA}$, $V_{CE} = 10\text{ Vdc}$)	V_{BE}	—	—	0.95	Vdc

SMALL–SIGNAL CHARACTERISTICS

Current Gain–Bandwidth Product ($V_{CE} = 10\text{ Vdc}$, $I_C = 4.0\text{ mA}$, $f = 100\text{ MHz}$)	f_T	650	—	—	MHz
Collector –Base Capacitance ($V_{CB} = 10\text{ Vdc}$, $I_E = 0$, $f = 1.0\text{ MHz}$)	C_{cb}	—	0.7	—	pF
Collector –Base Feedback Capacitance ($V_{CB} = 10\text{ Vdc}$, $I_E = 0$, $f = 1.0\text{ MHz}$)	C_{fb}	—	0.65	—	pF
Collector Base Time Constant ($I_C = 4.0\text{ mA}$, $V_{CB} = 10\text{ Vdc}$, $f = 31.8\text{ MHz}$)	τ_{bc}	—	—	9.0	ps

LMBTH10WT1G , S-LMBTH10WT1G

TYPICAL CHARACTERISTICS

COMMON-BASE y PARAMETERS versus FREQUENCY

($V_{CB} = 10 \text{ Vdc}$, $I_C = 4.0 \text{ mAdc}$, $T_A = 25^\circ\text{C}$)

y_{ib} , INPUT ADMITTANCE

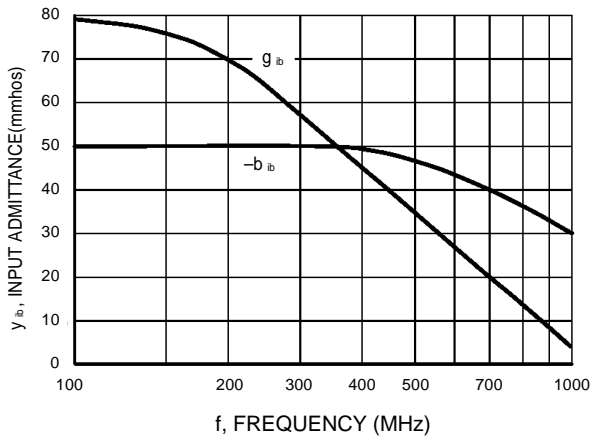

Figure 1. Rectangular Form

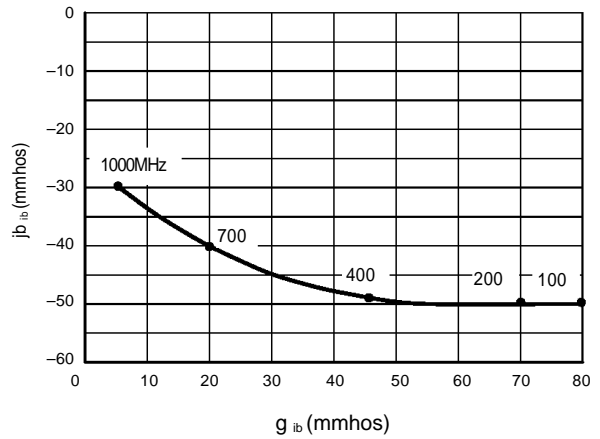

Figure 2. Polar Form

y_{fb} , FORWARD TRANSFER ADMITTANCE

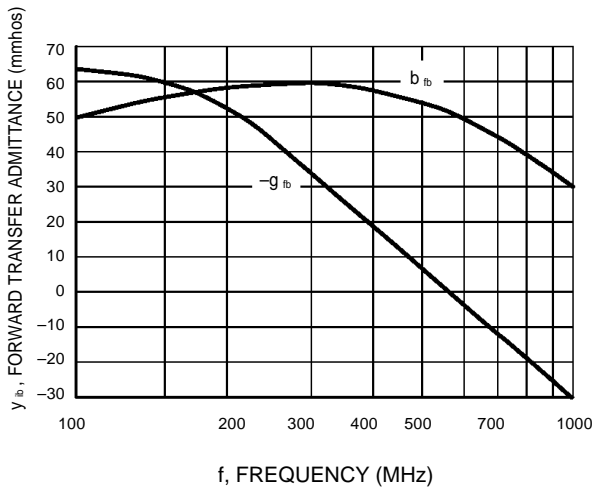

Figure 3. Rectangular Form

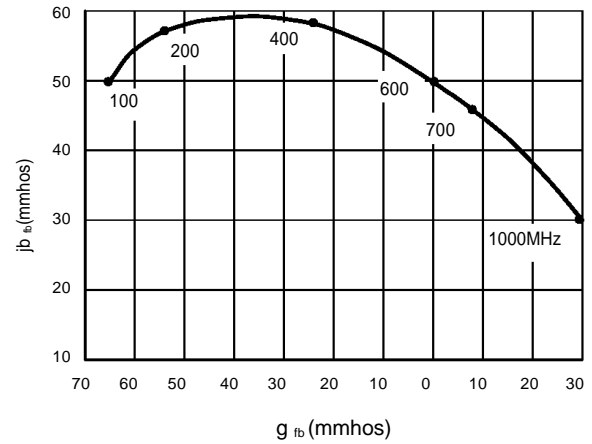

Figure 4. Polar Form

LMBTH10WT1G , S-LMBTH10WT1G

TYPICAL CHARACTERISTICS

COMMON-BASE y PARAMETERS versus FREQUENCY

($V_{CB} = 10$ Vdc, $I_C = 4.0$ mAdc, $T_A = 25^\circ\text{C}$)

y_{rb} , REVERSE TRANSFER ADMITTANCE

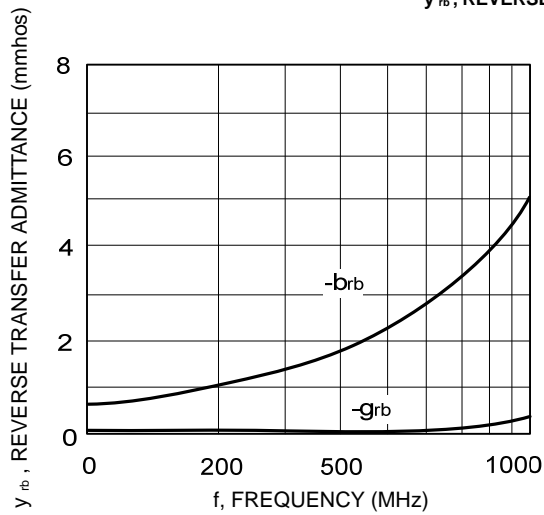

Figure 5. Rectangular Form

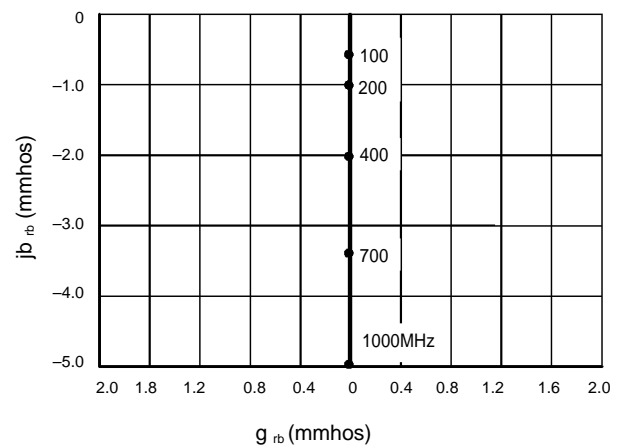

Figure 6. Polar Form

y_{ob} , OUTPUT ADMITTANCE

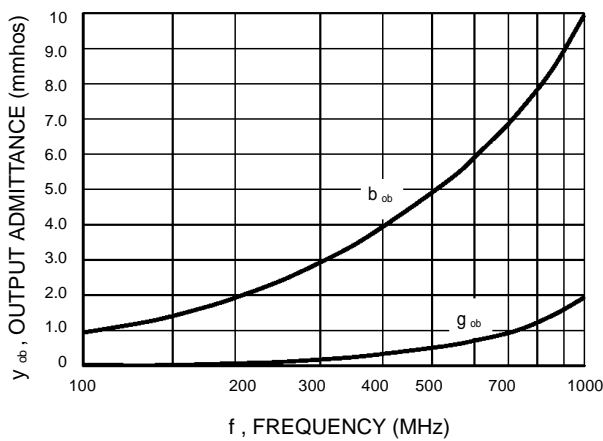

Figure 7. Rectangular Form

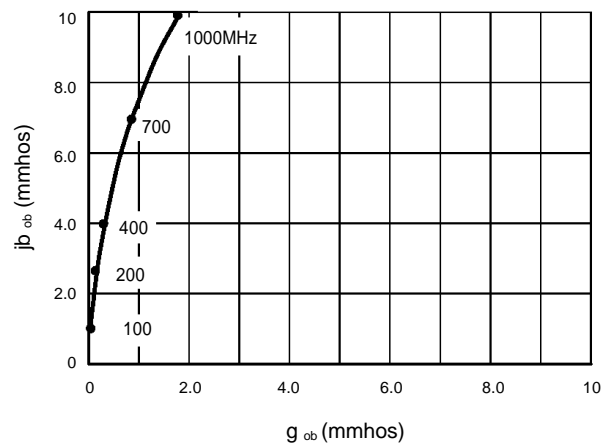
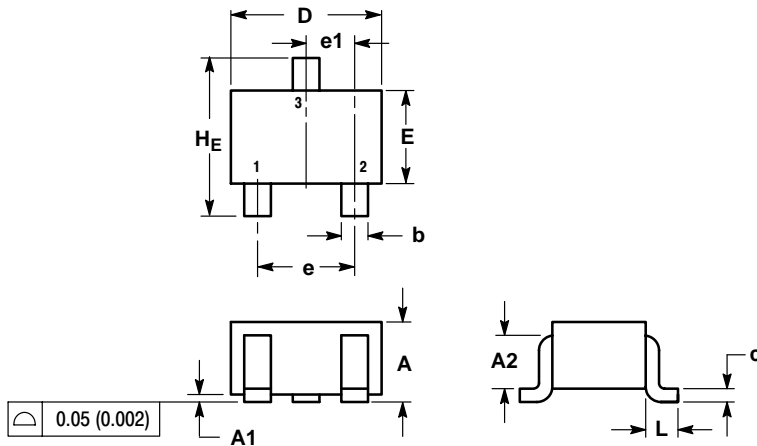

Figure 8. Polar Form

LMBTH10WT1G , S-LMBTH10WT1G

SC-70 / SOT-323



NOTES:
 1. DIMENSIONING AND TOLERANCING PER ANSI Y14.5M, 1982.
 2. CONTROLLING DIMENSION: INCH.

DIM	MILLIMETERS			INCHES		
	MIN	NOM	MAX	MIN	NOM	MAX
A	0.80	0.90	1.00	0.032	0.035	0.040
A1	0.00	0.05	0.10	0.000	0.002	0.004
A2	0.7 REF			0.028 REF		
b	0.30	0.35	0.40	0.012	0.014	0.016
c	0.10	0.18	0.25	0.004	0.007	0.010
D	1.80	2.10	2.20	0.071	0.083	0.087
E	1.15	1.24	1.35	0.045	0.049	0.053
e	1.20	1.30	1.40	0.047	0.051	0.055
e1	0.65 BSC			0.026 BSC		
L	0.425 REF			0.017 REF		
H	2.00	2.10	2.40	0.079	0.083	0.095

GENERIC MARKING DIAGRAM

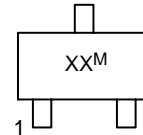

- XX = Specific Device Code
- M = Date Code
- = Pb-Free Package

*This information is generic. Please refer to device data sheet for actual part marking. Pb-Free indicator, "G" or microdot "▪", may or may not be present.

SOLDERING FOOTPRINT*

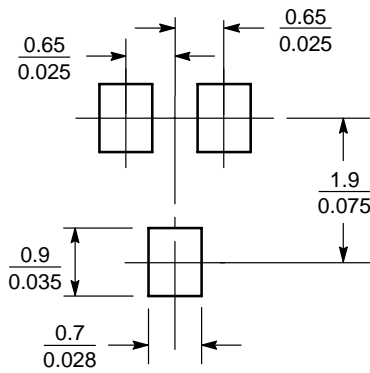

SCALE 10:1 (mm/inches)

EMBOSSED TAPE AND REEL DATA FOR DISCRETES

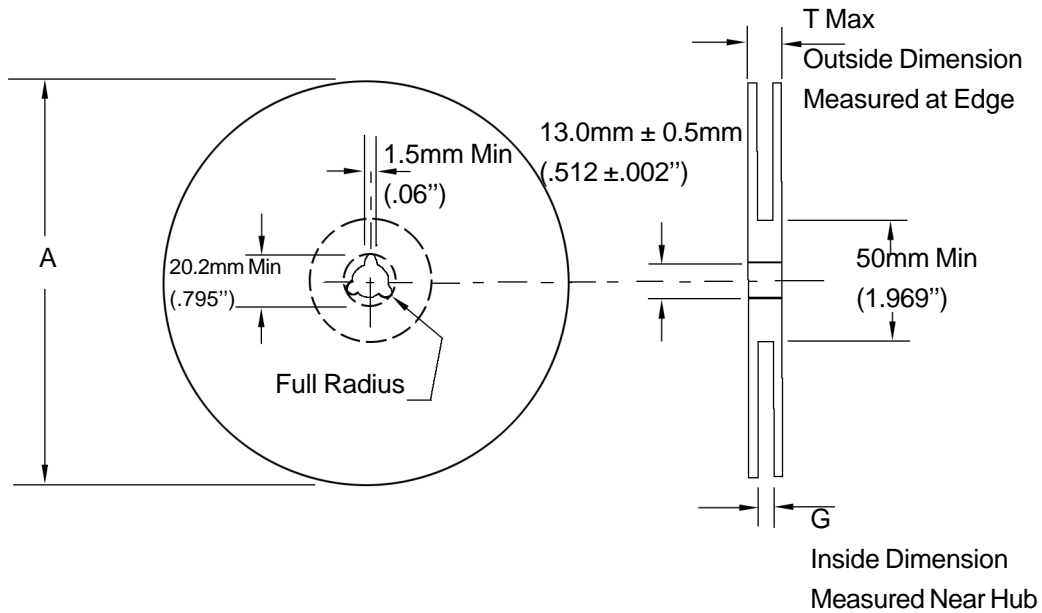

Size	A Max	G	T Max
8 mm	330mm (12.992")	8.4mm+1.5mm, -0.0 (.33"+.059", -0.00)	14.4mm (.56")

Reel Dimensions

Metric Dimensions Govern — English are in parentheses for reference only

Storage Conditions

Temperature: 5 to 40 Deg.C (20 to 30 Deg. C is preferred)

Humidity: 30 to 80 RH (40 to 60 is preferred)

Recommended Period: One year after manufacturing

(This recommended period is for the soldering condition only. The characteristics and reliabilities of the products are not restricted to this limitation)

Shipment Specification

