

LUMIMICRO – FLASH LED SPECIFICATION

FLASH WHITE LED

Super Luminosity White LED

MODEL: LMFLSP100

Customer		Model	LMFLSP100					
<table border="1"> <tr> <td>Checked By</td> <td>Approved By</td> </tr> <tr> <td> </td> <td> </td> </tr> </table>		Checked By	Approved By			Issued Date	2003 – 11 - 20	
		Checked By	Approved By					
		Description	Chip Type White LED					
Written By	Checked By	Approved by						

www.DataSheet4U.com

Lumimicro Co., Ltd
 362-43 Woncheon-dong, Yeongtonggu., Suwon-si,
 Gyeonggi-do, Korea
 Date: 2005-06-10,
 Tel:+82-31-213-9200, Fax: +8231-213-9210



LUMIMICRO CO., LTD

Features

- [1] Built-in 3chip Super-luminosity Chip LED
- [2] Built-in zener Diode- Flash LED
- [3] Super-luminosity chip LED
- [4] Blue LED + Organic - Inorganic Phosphore
- [5] Using a package with high heat dissipation properties, it can be driven with a large current
- [6] Wide viewing angle
- [7] External dimensions: 5.0 x 5.0 x 1.5t mm
- [8] Lead frame package with individual 6 pin

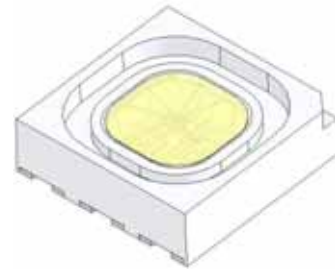

3 LED Chip Die + 3 Port Zener Diode

Model: LMFLSP100

Applications

- [1] Camera Flash
- [2] Hand Carrier Flash

Outline Dimensions

www.DataSheet4U.com

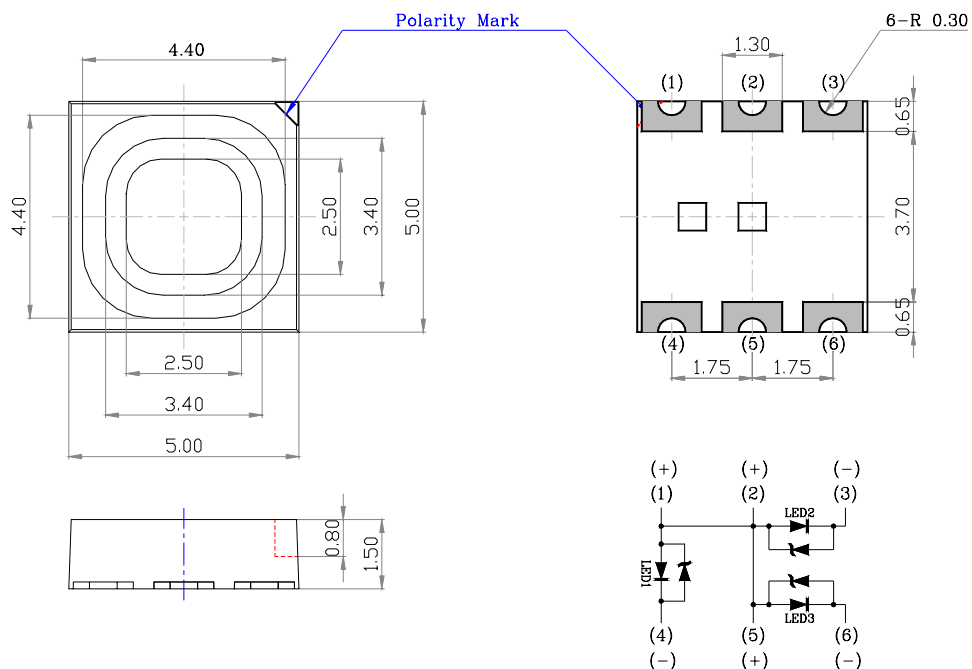

Unit: mm, Tolerance: ± 0.1

Absolute Maximum Ratings.

Parameter	Symbol	Rating Value	Unit
Power Dissipation	PD	300	mW
Forward Current	IF	90	mA
Forward Pulse Current	IPF	180	mA
Reverse Voltage	VR	5	V
Operating Temperature	TOT	-30 to +85	
Storage Temperature	TST	-40 to +100	
Soldering Temperature	TSD	Reflow: 240 for 10sec Hand Soldering: 350 for 10sec	

* Duty ratio=1/10, Pulse width < 30ms.

Electro-optical Spec.

Parameter	Symbol	Condition	Min	Typ.	Max	Unit
Forward Voltage 1	VF 1	IF=20m A/each chip	-	3.4	3.8	V
Forward Voltage 2	VF 2	IF=10uA	1.8	-	-	V
Luminous Intensity	IV	IF=20mA/ each chip	2.5	4.0	-	cd

The tolerance of Intensity measurement: ± 10%, The tolerance of VF measurement: ± 0.1V

C.I.E

x	y
0.290	0.276
0.290	0.320
0.330	0.318
0.330	0.365

www.DataSheet4U.co

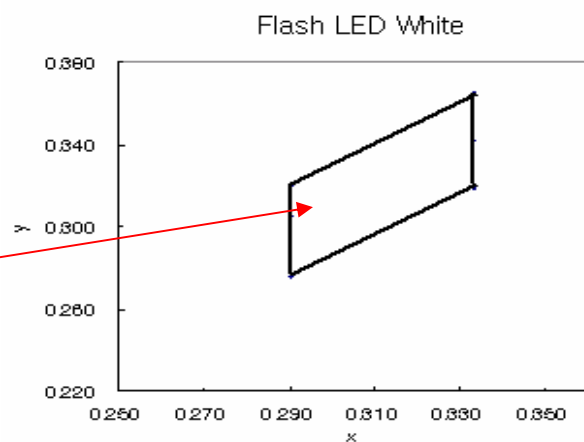
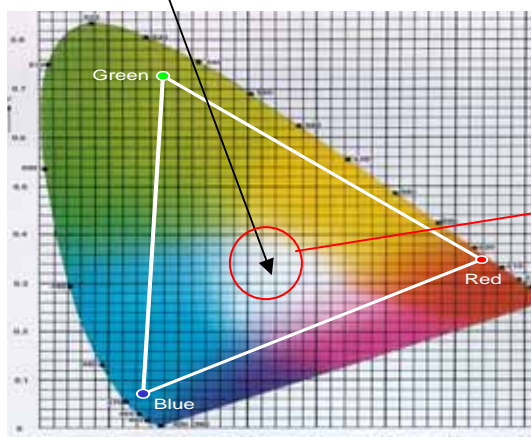

- The uncertainty of the C.I.E coordinates measurement: ± 0.01



LUMIMICRO CO., LTD

FLASH LED-LMFLSP100 - Optical & Electrical Characteristics

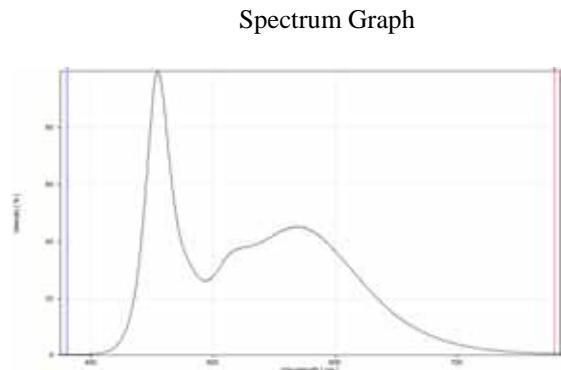
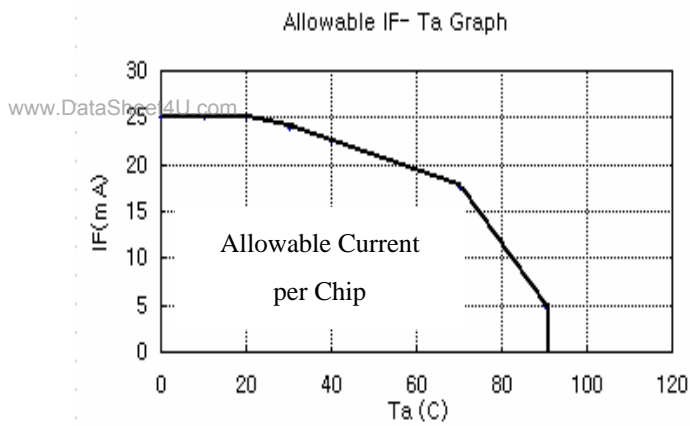
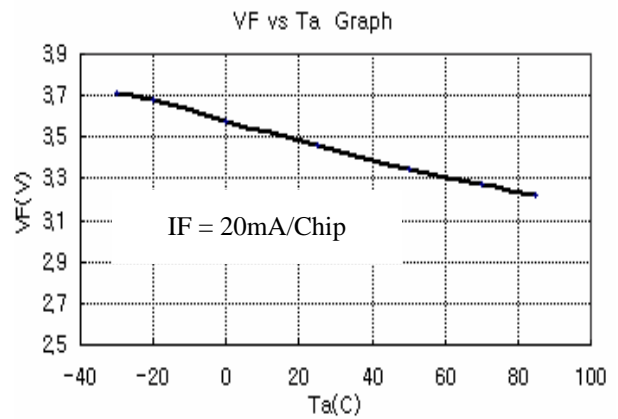
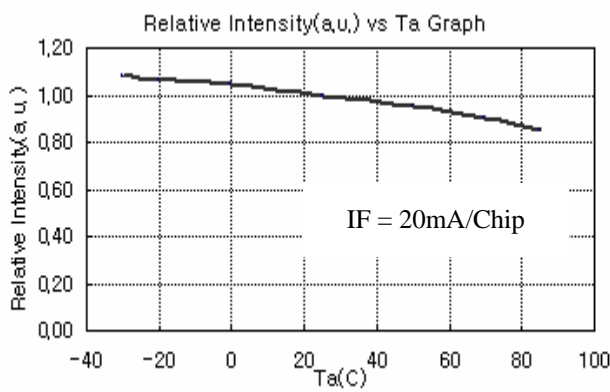
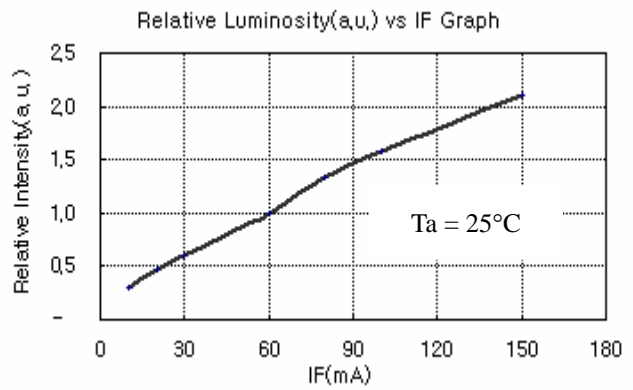
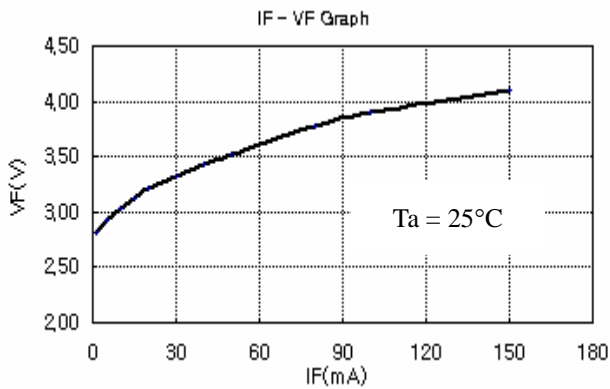

- VF : Forward Voltage(V), IF : Forward Current(m A), Ta : Ambient Temperature(°C)



Directivity (LMFLSP100)

X-axis-Directivity Graph(LMFLSP100)

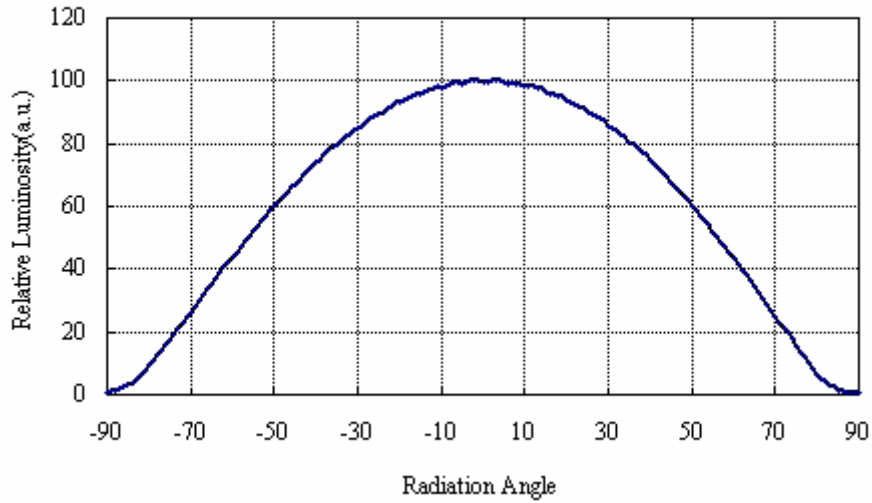

Y-axis-Directivity Graph(LMFLSP100)

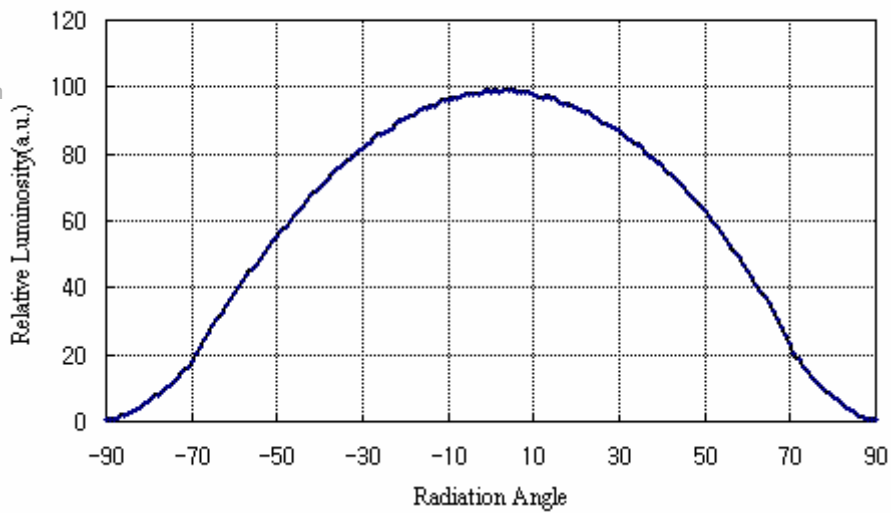

www.DataSheet4U.com



LUMIMICRO CO., LTD

Reliability Results

	ITEMS	CONDITION	NOTE	Fail/sample
1	RESISTANCE TO SOLDERING HEAT (REFLOW SOLDERING)	TSID=260°C, 10SEC (PRE TREATMENT 30°C, 70%, 168hrs)	2 TIMES	0/20
2	SOLDERBILITY (REFLOW SOLDERING)	TSID=215°C ± 5 °C, 3 SEC (LEAD SOLDER)	1 TIME OVER 95%	0/20
3	THERMAL SHOCK	-40°C ~ 100°C, 30min AT EACH TEMP.	10CYCLES	0/20
4	Vibration	10 ~ 2000 ~ 100Hz Sweep 4min, 200m/s ²	500 HRS	0/20
5	HIGH TEMPERATURE STORAGE	Ta = 100 °C	500 HRS	0/20
6	LIFE TIME 1	Curen = 25mA / One Chip @ ROOM TEMP.	500 HRS	0/20
7	LIFE TIME 2	Curen = 15mA / One Chip @ 60°C , 90%RH	300 HRS	0/20
8	ON / OFF TEST	IF = 180mA , Pulse Width 0.5sec, Duty Ratio 1/2	200,000Cycles	0/20

* Criteria For Failure

www.DataSheet4U.com

Item	Symbol	Model	Failure Criteria	
			Min	Max
Forward Voltage	VF	LMFLSP100	_	U.S.L*)×1.1
C.I.E. x,y	x,y	LMFLSP100	L.S.L*)×0.8	U.S.L*)×1.2
Luminous Intensity	IV	LMFLSP100	L.S.L*)×0.5	_

U.S.L*) : Upper Standard Level

L.S.L*) : Lower Standard Level



LUMIMICRO CO., LTD

Precautions For Use

This device should not be used in any type of fluid such as water, oil, organic solvent, etc.

When washing is required, IPA should be used.

When the LEDs are illuminating, operating current should be decided after considering the ambient maximum temperature.

LEDs must be stored to maintain a clean atmosphere. If the LEDs are stored for 3 months or more after being shipped from LUMIMICRO, sealed container with a nitrogen atmosphere should be used for storage.

The LEDs must be dip soldered within seven days after opening the moisture-proof packing. Repack unused Products with anti-moisture packing, fold to close any opening and then store in dry place. The appearance and specifications of the product may be modified for improvement without notice. These LEDs are sensitive to the static electricity and surge. It is recommended to use a wrist band or anti-electrostatic glove when handling the LEDs. If Over voltage which exceeds the absolute maximum rating is applied to LEDs, it will cause damage in LEDs and result in destruction. Damaged LEDs will show some unusual characteristics such as remarkably increased leak current, turn-on voltage becomes lower and the LEDs get unlighted at low current.

Soldering Condition

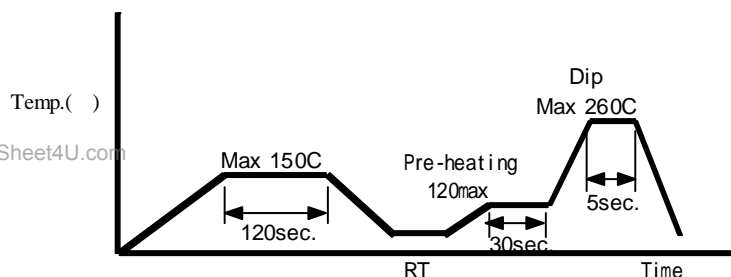

Solder Dip Conditions

The Immersion of leads into a solder bath @MAX260 shall be to 5 seconds max.

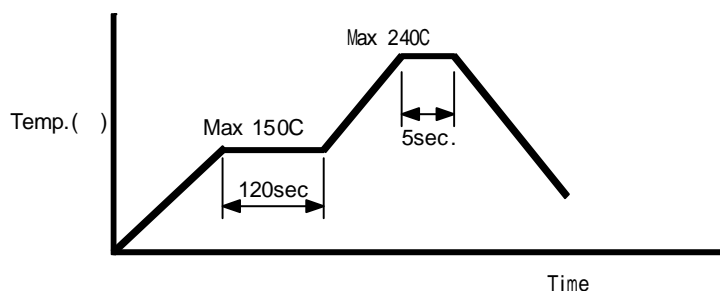

Reflow Conditions

Preliminary heating to be at 150 max. for 2 minutes max.
Soldering heat to be at 240 max. for 5 seconds max.

For Manual Soldering

Not more than 5 seconds @MAX300 , under Soldering iron.



LUMIMICRO CO., LTD

Recommended Soldering Pad Size

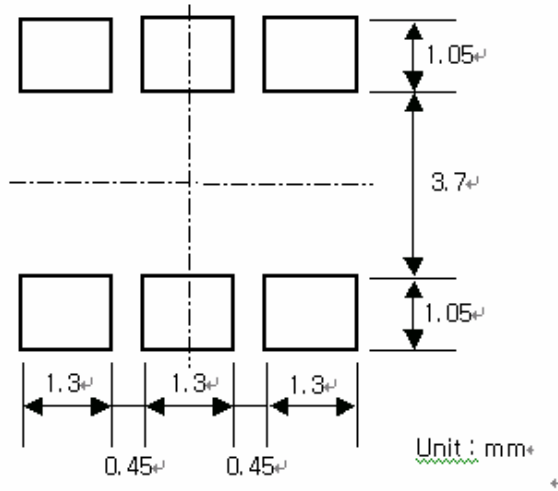

Taping pocket Dimension

www.DataSheet4U.com

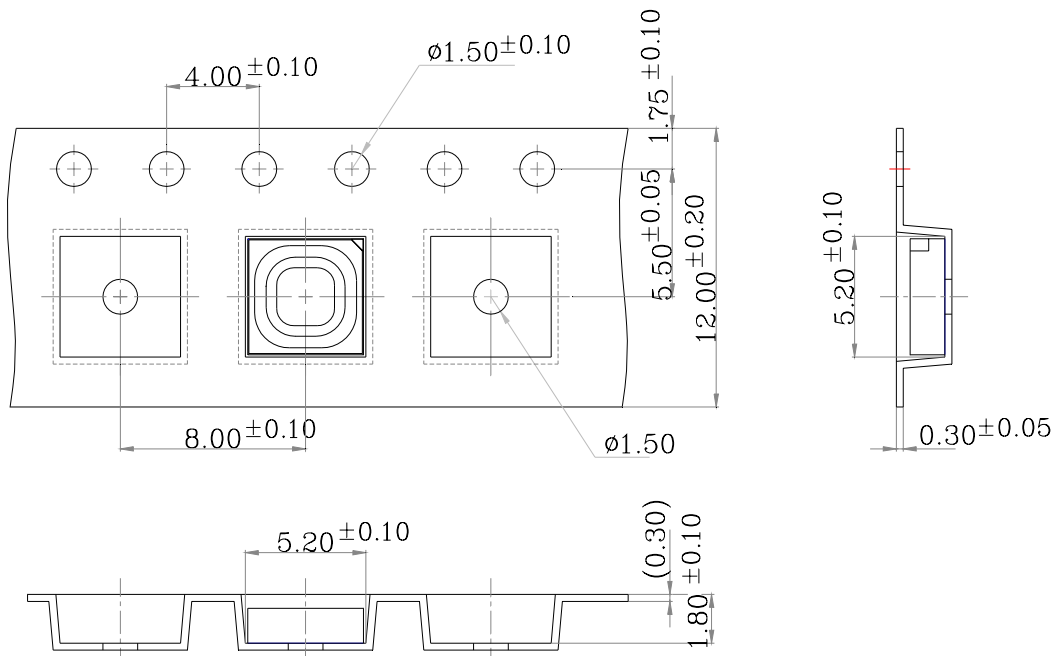

LUMIMICRO CO., LTD

Reel Dimensions

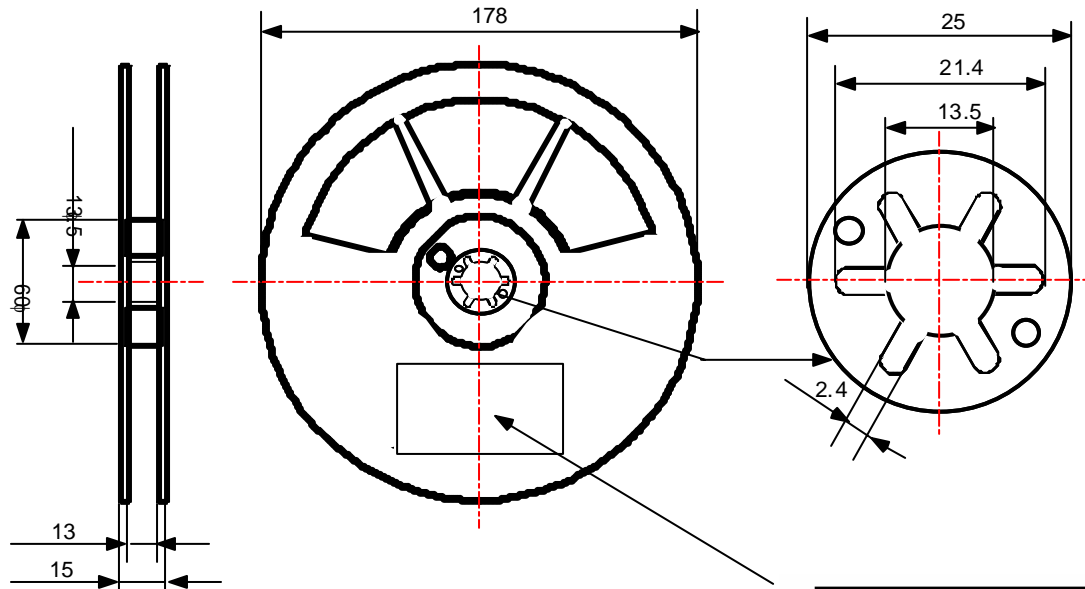

One Reel	Unit	Tolerance
Max 750EA	mm	± 0.1

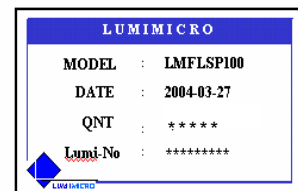

www.DataSheet4U.com

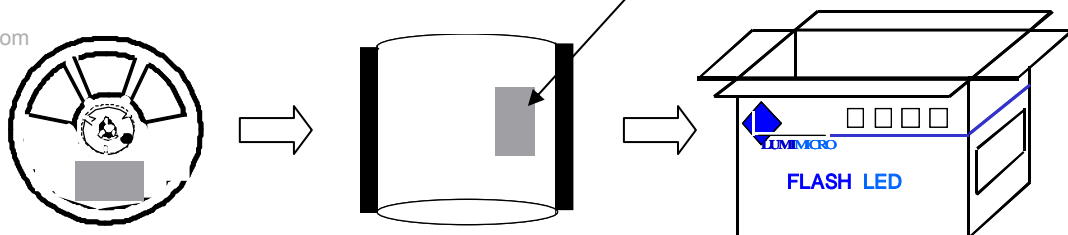

- Aluminum Bag

	Reel in a Bag	Silica in a Bag	Goods QNT in a Bag
Aluminum Bag	1 Reel	1 Silica	Max : 750ea

- Box Spec.

	Dimensions (Width/Thickness) Unit:mm	Reels in Box	Goods QNT in Box
Box-L1	275/ 285/ 50	10	Max : 7,500ea



LUMIMICRO CO., LTD

Label Spec.

LUMIMICRO	
MODEL : LMFLSP100	Model Name
DATE : 2004-03-27	Shipping Date
QNT : *****	Taping Quantity
Lumi-No : *****	Lumimicro-Lot Number

Weight: 65.1 mg (Measurement Tolerance: ± 10 %)

