

LMP7732

2.9 nV/sqrt(Hz) Low Noise, Precision, RRIO Amplifier

General Description

The LMP7732 is a dual low noise, low offset voltage, rail-to-rail input and output, low voltage precision amplifier. The LMP7732 is part of the LMP® precision amplifier family and is ideal for precision and low noise applications with low voltage requirements.

This operational amplifier offers low voltage noise of 2.9 nV/ $\sqrt{\text{Hz}}$ with a 1/f corner of only 3 Hz and low DC offset with a maximum value of $\pm 40 \mu\text{V}$, targeting high accuracy, low frequency applications. The LMP7732 has bipolar junction input stages with a bias current of only 1.5 nA. This low input bias current, complemented by the very low AC and DC levels of voltage noise, makes the LMP7732 an excellent choice for photometry applications.

The LMP7732 provides a wide GBW of 22 MHz while consuming only 4 mA of current. This high gain bandwidth along with the high open loop gain of 130 dB enables accurate signal conditioning in applications with high closed loop gain requirements.

The LMP7732 has a supply voltage range of 1.8V to 5.5V, making it an ideal choice for battery operated portable applications.

The LMP7732 is offered in an 8-pin SOIC.

The LMP7731 is the single version of this product and is offered in an 5-Pin SOT23 package.

Features

(Typical values, $T_A = 25^\circ\text{C}$, $V_S = 5\text{V}$)

■ Input voltage noise	
— $f = 3 \text{ Hz}$	3.3 nV/ $\sqrt{\text{Hz}}$
— $f = 1 \text{ kHz}$	2.9 nV/ $\sqrt{\text{Hz}}$
■ Offset voltage (max)	$\pm 40 \mu\text{V}$
■ Offset voltage drift (max)	$\pm 1.3 \mu\text{V}/^\circ\text{C}$
■ CMRR	130 dB
■ Open loop gain	130 dB
■ GBW	22 MHz
■ Slew rate	2.4 V/ μs
■ THD @ $f = 10 \text{ kHz}$, $A_V = 1$, $R_L = 2 \text{ k}\Omega$	0.001%
■ Supply current	4.4 mA
■ Supply voltage range	1.8V to 5.5V
■ Operating temperature range	-40°C to 125°C
■ Input bias current	$\pm 1.5 \text{ nA}$
■ RRIO	
■ 8-Pin SOIC package	

Applications

- Thermopile amplifier
- Gas analysis instruments
- Photometric instrumentation
- Medical instrumentation

Typical Application

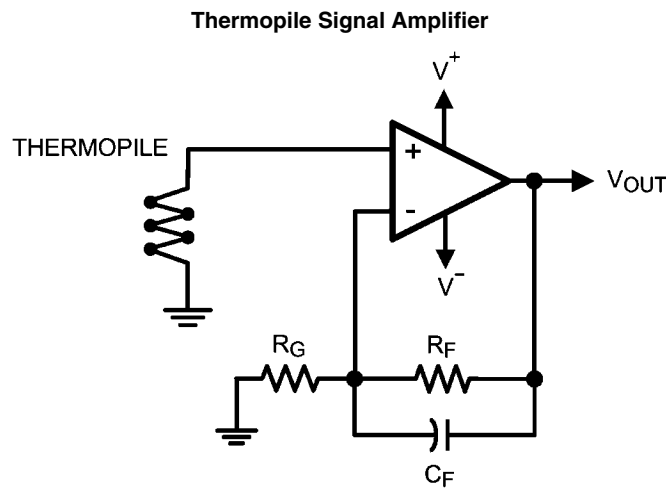

Absolute Maximum Ratings (Note 1)

If Military/Aerospace specified devices are required, please contact the National Semiconductor Sales Office/ Distributors for availability and specifications.

ESD Tolerance (Note 2)

Human Body Model

For inputs pins only

2000V

For all other pins

2000V

Machine Model

200V

Charge Device Model

1000V

 V_{IN} Differential $\pm 2V$ Supply Voltage ($V_S = V^+ - V^-$)

6.0V

Storage Temperature Range

-65°C to 150°C

Junction Temperature (Note 3)

+150°C max

Soldering Information

Infrared or Convection (20 sec)

235°C

Wave Soldering Lead Temp. (10 sec)

260°C

Operating Ratings (Note 1)

Temperature Range

-40°C to 125°C

Supply Voltage ($V_S = V^+ - V^-$)

1.8V to 5.5V

Package Thermal Resistance (θ_{JA})

8-Pin SOIC

190 °C/W

2.5V Electrical Characteristics (Note 4)

Unless otherwise specified, all limits are guaranteed for $T_A = 25^\circ\text{C}$, $V^+ = 2.5\text{V}$, $V^- = 0\text{V}$, $V_{CM} = V^+/2$, $R_L > 10\text{ k}\Omega$ to $V^+/2$. **Bold-face** limits apply at the temperature extremes.

Symbol	Parameter	Conditions	Min (Note 6)	Typ (Note 5)	Max (Note 6)	Units
V_{OS}	Input Offset Voltage (Note 7)	$V_{CM} = 2.0V$		± 9	± 50 ± 150	μV
		$V_{CM} = 0.5V$		± 9	± 40 ± 125	
TCV_{OS}	Input Offset Voltage Drift	$V_{CM} = 2.0V$		± 0.5	± 1.3	$\mu\text{V}/^\circ\text{C}$
		$V_{CM} = 0.5V$		± 0.2	± 0.8	
	Input Offset Voltage Time Drift	$V_{CM} = 0.5V$ and $V_{CM} = 2.0V$		0.35		$\mu\text{V}/\text{month}$
I_B	Input Bias Current	$V_{CM} = 2.0V$		± 1	± 30 ± 45	nA
		$V_{CM} = 0.5V$		± 12	± 50 ± 75	
I_{OS}	Input Offset Current	$V_{CM} = 2.0V$		± 1	± 50 ± 75	nA
		$V_{CM} = 0.5V$		± 11	± 60 ± 80	
TCI_{OS}	Input Offset Current Drift	$V_{CM} = 0.5V$ and $V_{CM} = 2.0V$		0.0474		$\text{nA}/^\circ\text{C}$
CMRR	Common Mode Rejection Ratio	$0.15V \leq V_{CM} \leq 0.7V$	101	120		dB
		$0.23V \leq V_{CM} \leq 0.7V$	89			
		$1.5V \leq V_{CM} \leq 2.35V$	105	129		
		$1.5V \leq V_{CM} \leq 2.27V$	99			
PSRR	Power Supply Rejection Ratio	$2.5V \leq V^+ \leq 5V$	111 105	129		dB
		$1.8V \leq V^+ \leq 5.5V$		117		
CMVR	Input Common-Mode Voltage Range	Large Signal CMRR $\geq 80\text{ dB}$	0		2.5	V
A_{VOL}	Large Signal Voltage Gain	$R_L = 10\text{ k}\Omega$ to $V^+/2$	112	130		dB
		$V_O = 0.5V$ to $2.0V$	104			
		$R_L = 2\text{ k}\Omega$ to $V^+/2$	109	119		
		$V_O = 0.5V$ to $2.0V$	90			

Symbol	Parameter	Conditions	Min (Note 6)	Typ (Note 5)	Max (Note 6)	Units
V_O	Output Swing High	$R_L = 10\text{ k}\Omega$ to $V+/2$		4	50 75	mV from either rail
		$R_L = 2\text{ k}\Omega$ to $V+/2$		13	50 75	
	Output Swing Low	$R_L = 10\text{ k}\Omega$ to $V+/2$		6	50 75	
		$R_L = 2\text{ k}\Omega$ to $V+/2$		9	50 75	
I_O	Output Short Circuit Current	Sourcing, $V_O = V+/2$ $V_{IN}(\text{diff}) = 100\text{ mV}$	22 12	31		mA
		Sinking, $V_O = V+/2$ $V_{IN}(\text{diff}) = -100\text{ mV}$	15 10	44		
I_S	Supply Current	$V_{CM} = 2.0\text{V}$		4.0	5.4 6.8	mA
		$V_{CM} = 0.5\text{V}$		4.6	6.2 7.8	
SR	Slew Rate	$A_V = +1$, $C_L = 10\text{ pF}$, $R_L = 10\text{ k}\Omega$ to $V+/2$ $V_O = 2\text{ V}_{PP}$		2.4		V/ μs
GBW	Gain Bandwidth Product	$C_L = 20\text{ pF}$, $R_L = 10\text{ k}\Omega$ to $V+/2$		21		MHz
G_M	Gain Margin	$C_L = 20\text{ pF}$, $R_L = 10\text{ k}\Omega$ to $V+/2$		14		dB
Φ_M	Phase Margin	$C_L = 20\text{ pF}$, $R_L = 10\text{ k}\Omega$ to $V+/2$		60		deg
R_{IN}	Input Resistance	Differential Mode		38		k Ω
		Common Mode		151		M Ω
THD	Total Harmonic Distortion	$A_V = 1$, $f_O = 1\text{ kHz}$, Amplitude = 1V		0.002		%
e_n	Input-Referred Voltage Noise	$f = 1\text{ kHz}$, $V_{CM} = 2.0\text{V}$		3.0		nV/ $\sqrt{\text{Hz}}$
		$f = 1\text{ kHz}$, $V_{CM} = 0.5\text{V}$		3.0		
	0.1 Hz to 10 Hz			75		nV $_{PP}$
i_n	Input-Referred Current Noise	$f = 1\text{ kHz}$, $V_{CM} = 2.0\text{V}$		1.1		pA/ $\sqrt{\text{Hz}}$
		$f = 1\text{ kHz}$, $V_{CM} = 0.5\text{V}$		2.3		

3.3V Electrical Characteristics (Note 4)

Unless otherwise specified, all limits are guaranteed for $T_A = 25^\circ\text{C}$, $V^+ = 3.3\text{V}$, $V^- = 0\text{V}$, $V_{CM} = V+/2$, $R_L > 10\text{ k}\Omega$ to $V+/2$. **Bold-face** limits apply at the temperature extremes.

Symbol	Parameter	Conditions	Min (Note 6)	Typ (Note 5)	Max (Note 6)	Units
V_{OS}	Input Offset Voltage (Note 7)	$V_{CM} = 2.5\text{V}$		± 6	± 50 ± 150	μV
		$V_{CM} = 0.5\text{V}$		± 6	± 40 ± 125	
TCV_{OS}	Input Offset Voltage Drift	$V_{CM} = 2.5\text{V}$		± 0.5	± 1.3	$\mu\text{V}/^\circ\text{C}$
		$V_{CM} = 0.5\text{V}$		± 0.2	± 0.8	
	Input Offset Voltage Time Drift	$V_{CM} = 0.5\text{V}$ and $V_{CM} = 2.5\text{V}$		0.35		$\mu\text{V}/\text{month}$
I_B	Input Bias Current	$V_{CM} = 2.5\text{V}$		± 1.5	± 30 ± 45	nA
		$V_{CM} = 0.5\text{V}$		± 13	± 50 ± 77	
I_{OS}	Input Offset Current	$V_{CM} = 2.5\text{V}$		± 1	± 50 ± 70	nA
		$V_{CM} = 0.5\text{V}$		± 11	± 60 ± 80	

Symbol	Parameter	Conditions	Min (Note 6)	Typ (Note 5)	Max (Note 6)	Units
$TC_{I_{OS}}$	Input Offset Current Drift	$V_{CM} = 0.5V$ and $V_{CM} = 2.5V$		0.048		nA/°C
CMRR	Common Mode Rejection Ratio	$0.15V \leq V_{CM} \leq 0.7V$ $0.23V \leq V_{CM} \leq 0.7V$	101 89	120		dB
		$1.5V \leq V_{CM} \leq 3.15V$ $1.5V \leq V_{CM} \leq 3.07V$	105 99	130		
PSRR	Power Supply Rejection Ratio	$2.5V \leq V^+ \leq 5.0V$	111 105	129		dB
		$1.8V \leq V^+ \leq 5.5V$		117		
CMVR	Input Common-Mode Voltage Range	Large Signal CMRR ≥ 80 dB	0		3.3	V
A_{VOL}	Large Signal Voltage Gain	$R_L = 10\text{ k}\Omega$ to $V^+/2$ $V_O = 0.5V$ to $2.8V$	112 104	130		dB
		$R_L = 2\text{ k}\Omega$ to $V^+/2$ $V_O = 0.5V$ to $2.8V$	110 92	119		
V_O	Output Swing High	$R_L = 10\text{ k}\Omega$ to $V^+/2$		5	50 75	mV from either rail
		$R_L = 2\text{ k}\Omega$ to $V^+/2$		14	50 75	
	Output Swing Low	$R_L = 10\text{ k}\Omega$ to $V^+/2$		9	50 75	
		$R_L = 2\text{ k}\Omega$ to $V^+/2$		13	50 75	
I_O	Output Short Circuit Current	Sourcing, $V_O = V^+/2$ $V_{IN}(\text{diff}) = 100\text{ mV}$	28 22	45		mA
		Sinking, $V_O = V^+/2$ $V_{IN}(\text{diff}) = -100\text{ mV}$	25 20	48		
I_S	Supply Current	$V_{CM} = 2.5V$		4.2	5.6 7.0	mA
		$V_{CM} = 0.5V$		4.8	6.4 8.0	
SR	Slew Rate	$A_V = +1$, $C_L = 10\text{ pF}$, $R_L = 10\text{ k}\Omega$ to $V^+/2$ $V_O = 2 V_{PP}$		2.4		V/ μ s
GBW	Gain Bandwidth Product	$C_L = 20\text{ pF}$, $R_L = 10\text{ k}\Omega$ to $V^+/2$		22		MHz
G_M	Gain Margin	$C_L = 20\text{ pF}$, $R_L = 10\text{ k}\Omega$ to $V^+/2$		14		dB
Φ_M	Phase Margin	$C_L = 20\text{ pF}$, $R_L = 10\text{ k}\Omega$ to $V^+/2$		62		deg
THD	Total Harmonic Distortion	$A_V = 1$, $f_O = 1\text{ kHz}$, Amplitude = 1V		0.002		%
R_{IN}	Input Resistance	Differential Mode		38		k Ω
		Common Mode		151		M Ω
e_n	Input-Referred Voltage Noise	$f = 1\text{ kHz}$, $V_{CM} = 2.5V$		2.9		nV/ $\sqrt{\text{Hz}}$
		$f = 1\text{ kHz}$, $V_{CM} = 0.5V$		2.9		
	0.1 Hz to 10 Hz			75		nV $_{PP}$
i_n	Input-Referred Current Noise	$f = 1\text{ kHz}$, $V_{CM} = 2.5V$		1.1		pA/ $\sqrt{\text{Hz}}$
		$f = 1\text{ kHz}$, $V_{CM} = 0.5V$		2.1		

5V Electrical Characteristics (Note 4)

Unless otherwise specified, all limits are guaranteed for $T_A = 25^\circ\text{C}$, $V^+ = 5\text{V}$, $V^- = 0\text{V}$, $V_{\text{CM}} = V^+/2$, $R_L > 10\text{ k}\Omega$ to $V^+/2$. **Boldface** limits apply at the temperature extremes.

Symbol	Parameter	Conditions	Min (Note 6)	Typ (Note 5)	Max (Note 6)	Units
V_{OS}	Input Offset Voltage (Note 7)	$V_{\text{CM}} = 4.5\text{V}$		± 6	± 50 ± 150	μV
		$V_{\text{CM}} = 0.5\text{V}$		± 6	± 40 ± 125	
TCV_{OS}	Input Offset Voltage Drift	$V_{\text{CM}} = 4.5\text{V}$		± 0.5	± 1.3	$\mu\text{V}/^\circ\text{C}$
		$V_{\text{CM}} = 0.5\text{V}$		± 0.2	± 0.8	
	Input Offset Voltage Time Drift	$V_{\text{CM}} = 0.5\text{V}$ and $V_{\text{CM}} = 4.5\text{V}$		0.35		$\mu\text{V}/\text{month}$
I_{B}	Input Bias Current	$V_{\text{CM}} = 4.5\text{V}$		± 1.5	± 30 ± 50	nA
		$V_{\text{CM}} = 0.5\text{V}$		± 14	± 50 ± 85	
I_{OS}	Input Offset Current	$V_{\text{CM}} = 4.5\text{V}$		± 1	± 50 ± 70	nA
		$V_{\text{CM}} = 0.5\text{V}$		± 11	± 65 ± 80	
TCI_{OS}	Input Offset Current Drift	$V_{\text{CM}} = 0.5\text{V}$ and $V_{\text{CM}} = 4.5\text{V}$		0.0482		$\text{nA}/^\circ\text{C}$
CMRR	Common Mode Rejection Ratio	$0.15\text{V} \leq V_{\text{CM}} \leq 0.7\text{V}$	101	120		dB
		$0.23\text{V} \leq V_{\text{CM}} \leq 0.7\text{V}$	89			
		$1.5\text{V} \leq V_{\text{CM}} \leq 4.85\text{V}$	105	130		
		$1.5\text{V} \leq V_{\text{CM}} \leq 4.77\text{V}$	99			
PSRR	Power Supply Rejection Ratio	$2.5\text{V} \leq V^+ \leq 5\text{V}$	111	129		dB
		$1.8\text{V} \leq V^+ \leq 5.5\text{V}$		117		
CMVR	Input Common-Mode Voltage Range	Large Signal CMRR $\geq 80\text{ dB}$	0		5	V
A_{VOL}	Large Signal Voltage Gain	$R_L = 10\text{ k}\Omega$ to $V^+/2$ $V_O = 0.5\text{V}$ to 4.5V	112	130		dB
		$R_L = 2\text{ k}\Omega$ to $V^+/2$ $V_O = 0.5\text{V}$ to 4.5V	110	119		
			94			
V_{O}	Output Swing High	$R_L = 10\text{ k}\Omega$ to $V^+/2$		8	50 75	mV from either rail
		$R_L = 2\text{ k}\Omega$ to $V^+/2$		24	50 75	
	Output Swing Low	$R_L = 10\text{ k}\Omega$ to $V^+/2$		9	50 75	
		$R_L = 2\text{ k}\Omega$ to $V^+/2$		23	50 75	
I_{O}	Output Short Circuit Current	Sourcing, $V_O = V^+/2$ $V_{\text{IN}}(\text{diff}) = 100\text{ mV}$	33	47		mA
		Sinking, $V_O = V^+/2$ $V_{\text{IN}}(\text{diff}) = -100\text{ mV}$	27			
			30	49		
			25			
I_{S}	Supply Current	$V_{\text{CM}} = 4.5\text{V}$		4.4	6.0 7.4	mA
		$V_{\text{CM}} = 0.5\text{V}$		5.0	6.8 8.4	
SR	Slew Rate	$A_V = +1$, $C_L = 10\text{ pF}$, $R_L = 10\text{ k}\Omega$ to $V^+/2$ $V_O = 2 V_{\text{PP}}$		2.4		$\text{V}/\mu\text{s}$

Symbol	Parameter	Conditions	Min (Note 6)	Typ (Note 5)	Max (Note 6)	Units
GBW	Gain Bandwidth Product	$C_L = 20 \text{ pF}$, $R_L = 10 \text{ k}\Omega$ to $V+/2$		22		MHz
G_M	Gain Margin	$C_L = 20 \text{ pF}$, $R_L = 10 \text{ k}\Omega$ to $V+/2$		12		dB
Φ_M	Phase Margin	$C_L = 20 \text{ pF}$, $R_L = 10 \text{ k}\Omega$ to $V+/2$		65		deg
R_{IN}	Input Resistance	Differential Mode		38		$\text{k}\Omega$
		Common Mode		151		$\text{M}\Omega$
THD	Total Harmonic Distortion	$A_V = 1$, $f_O = 1 \text{ kHz}$, Amplitude = 1V		0.001		%
e_n	Input-Referred Voltage Noise	$f = 1 \text{ kHz}$, $V_{CM} = 4.5\text{V}$		2.9		$\text{nV}/\sqrt{\text{Hz}}$
		$f = 1 \text{ kHz}$, $V_{CM} = 0.5\text{V}$		2.9		
	0.1 Hz to 10 Hz			75		nV_{PP}
i_n	Input-Referred Current Noise	$f = 1 \text{ kHz}$, $V_{CM} = 4.5\text{V}$		1.1		$\text{pA}/\sqrt{\text{Hz}}$
		$f = 1 \text{ kHz}$, $V_{CM} = 0.5\text{V}$		2.2		

Note 1: Absolute Maximum Ratings indicate limits beyond which damage to the device may occur. Operating Ratings indicate conditions for which the device is intended to be functional, but specific performance is not guaranteed. For guaranteed specifications and the test conditions, see the Electrical Characteristics Tables.

Note 2: Human Body Model, applicable std. MIL-STD-883, Method 3015.7. Machine Model, applicable std. JESD22-A115-A (ESD MM std. of JEDEC) Field-Induced Charge-Device Model, applicable std. JESD22-C101-C (ESD FICDM std. of JEDEC).

Note 3: The maximum power dissipation is a function of $T_{J(MAX)}$, θ_{JA} , and T_A . The maximum allowable power dissipation at any ambient temperature is $P_D = (T_{J(MAX)} - T_A) / \theta_{JA}$. All numbers apply for packages soldered directly onto a PC board.

Note 4: Electrical Table values apply only for factory testing conditions at the temperature indicated. Factory testing conditions result in very limited self-heating of the device such that $T_j = T_A$. No guarantee of parametric performance is indicated in the electrical tables under conditions of internal self-heating where $T_j > T_A$. Absolute maximum Ratings indicate junction temperature limits beyond which the device maybe permanently degraded, either mechanically or electrically.

Note 5: Typical values represent the most likely parametric norm as determined at the time of characterization. Actual typical values may vary over time and will also depend on the application and configuration. The typical values are not tested and are not guaranteed on shipped production material.

Note 6: All limits are guaranteed by testing, statistical analysis or design.

Note 7: Ambient production test is performed at 25°C with a variance of $\pm 3^\circ\text{C}$.

Connection Diagram

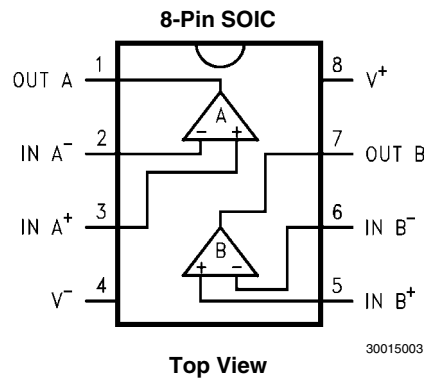

Ordering Information

Package	Part Number	Package Marking	Transport Media	NSC Drawing
8-Pin SOIC	LMP7732MA	LMP7732MA	95 units/Rails	M08A
	LMP7732MAX		2.5k Units Tape and Reel	

Typical Performance Characteristics Unless otherwise noted: $T_A = 25^\circ\text{C}$, $R_L > 10\text{ k}\Omega$, $V_{CM} = V_S/2$.

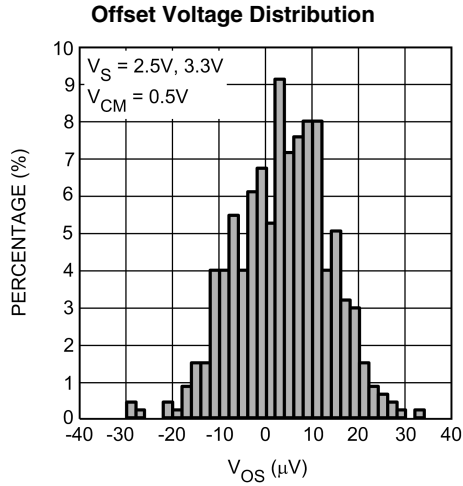

30015071

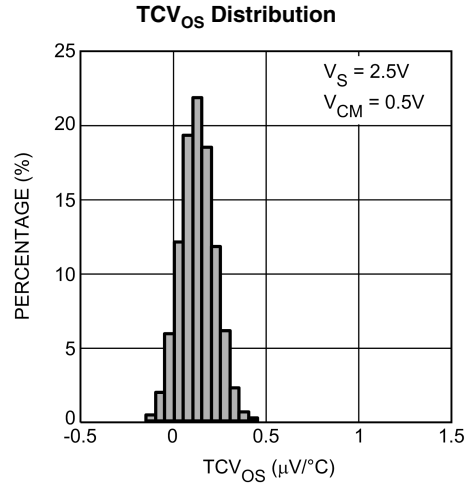

30015076

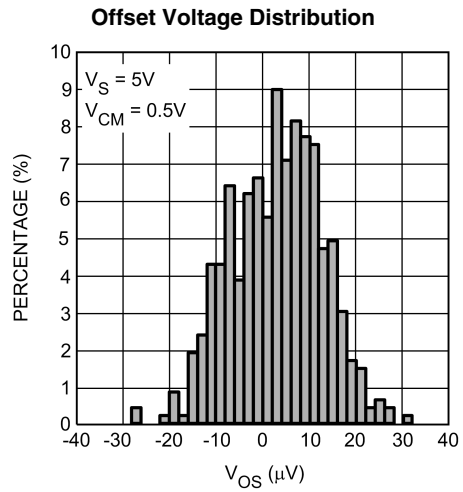

30015073

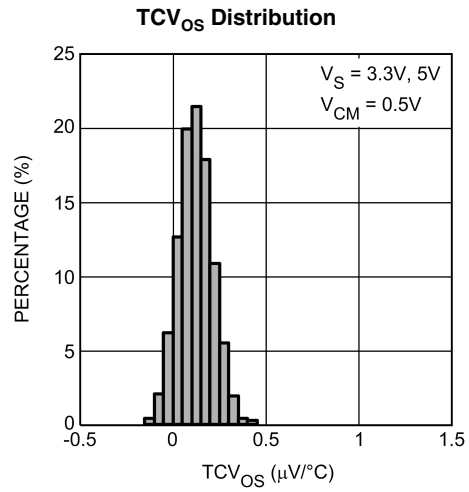

30015074

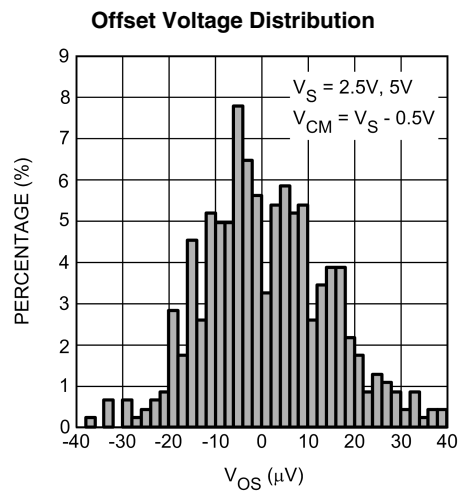

30015070

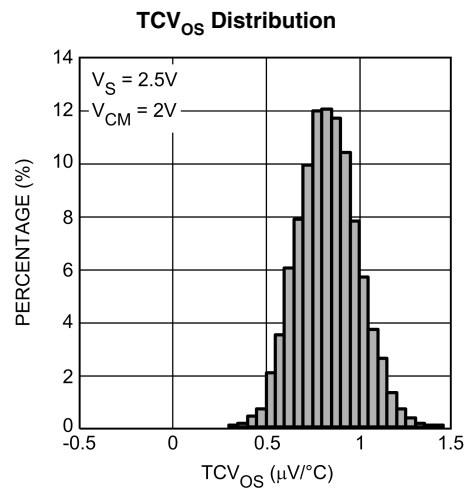

30015077

Offset Voltage Distribution

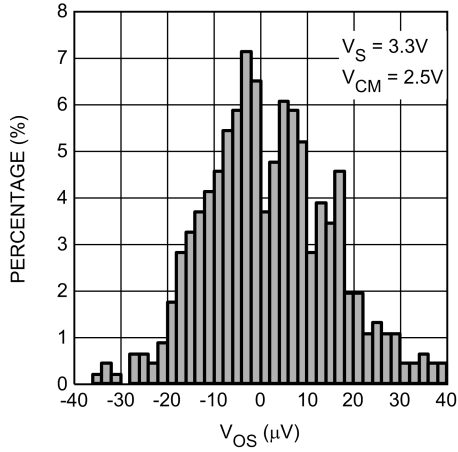

30015072

TCV_{OS} Distribution

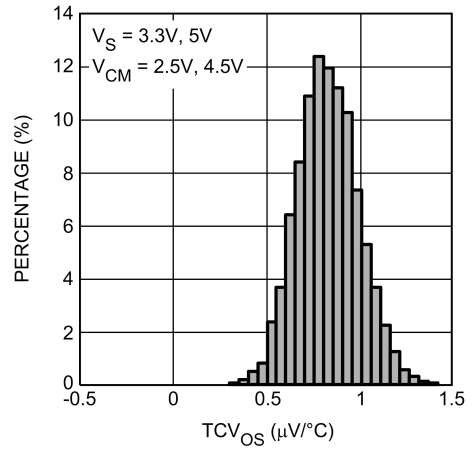

30015075

Offset Voltage vs. Temperature

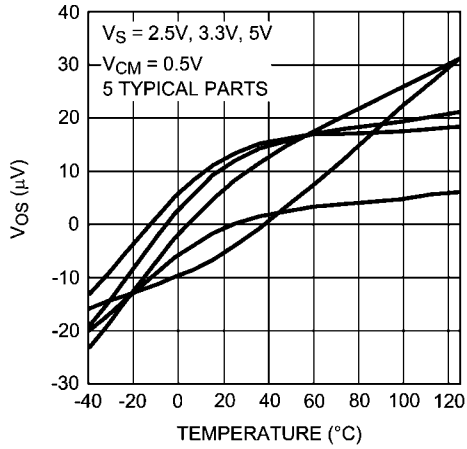

30015082

Offset Voltage vs. Temperature

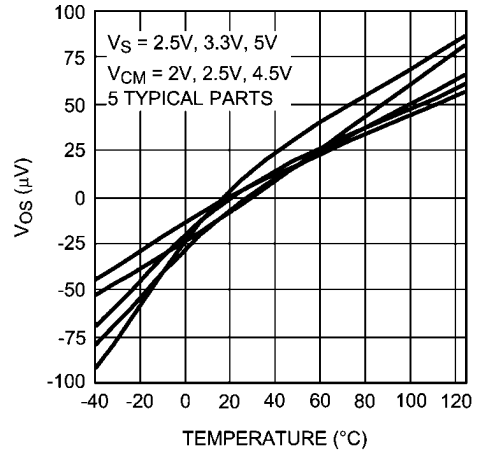

30015083

PSRR vs. Frequency

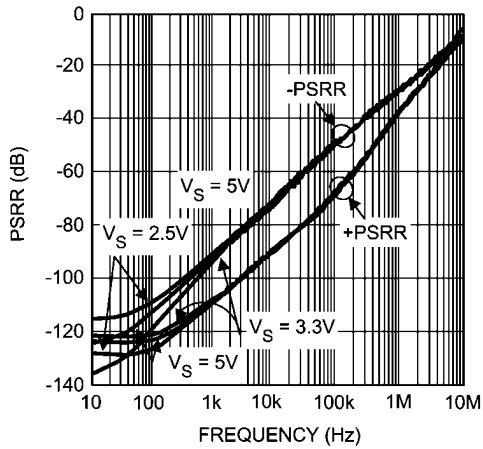

30015029

CMRR vs. Frequency

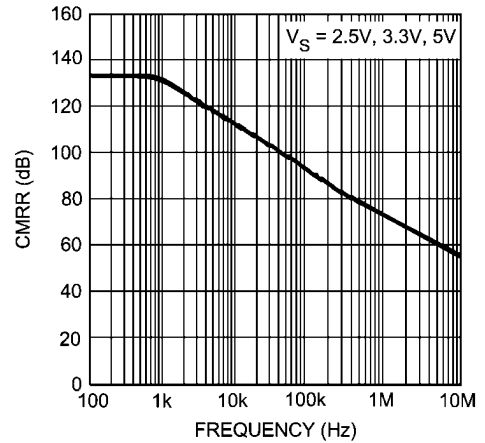

30015062

Offset Voltage vs. Supply Voltage

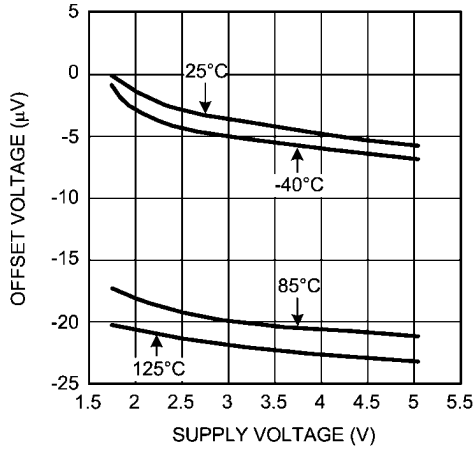

30015053

Offset Voltage vs. V_{CM}

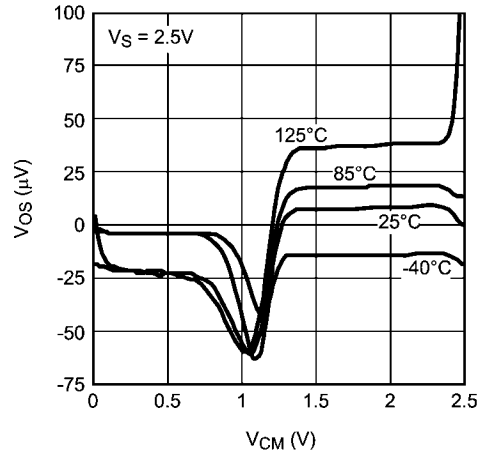

30015054

Offset Voltage vs. V_{CM}

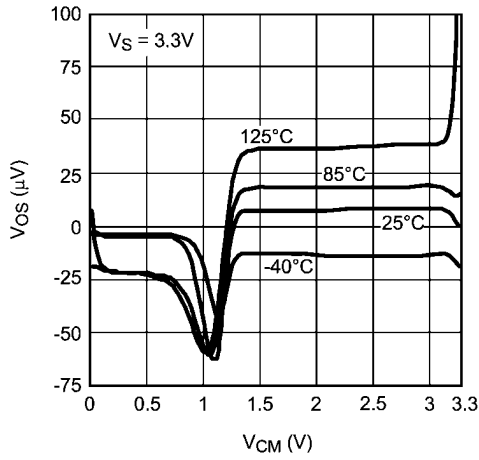

30015055

Offset Voltage vs. V_{CM}

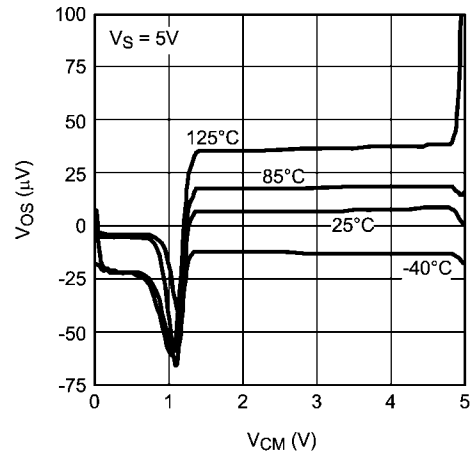

30015056

Input Offset Voltage Time Drift

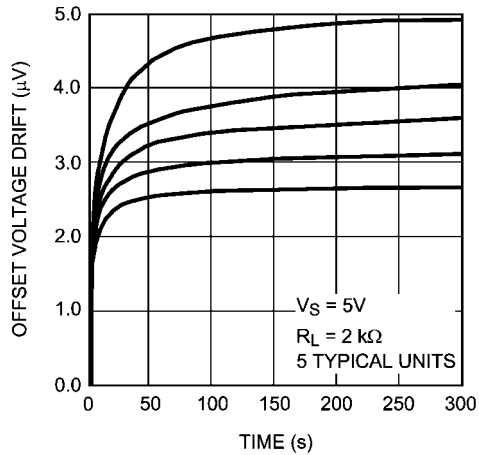

30015080

Slew Rate vs. Supply Voltage

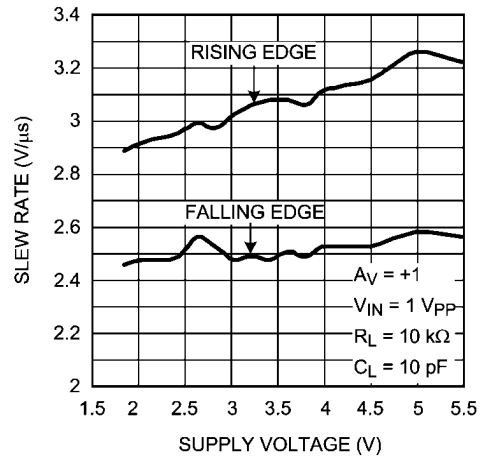

30015020

Input Voltage Noise vs. Frequency

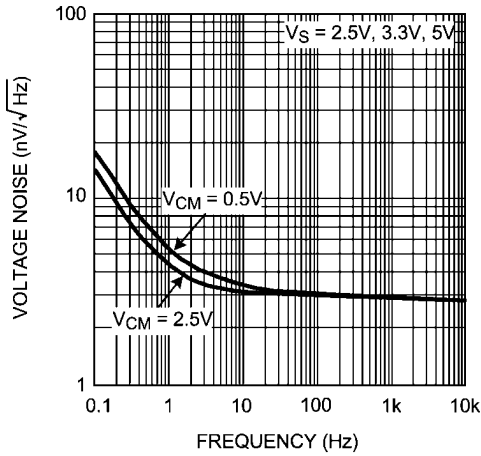

30015063

Input Current Noise vs. Frequency

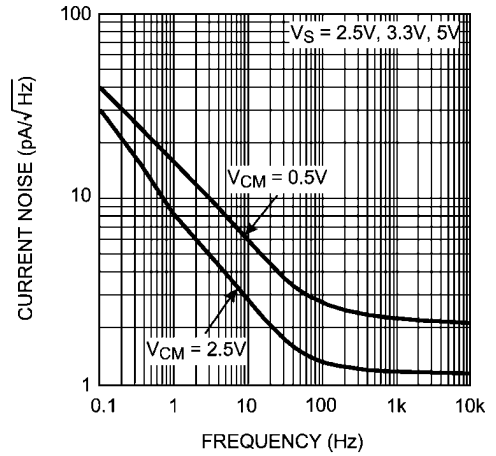

30015064

Time Domain Voltage Noise

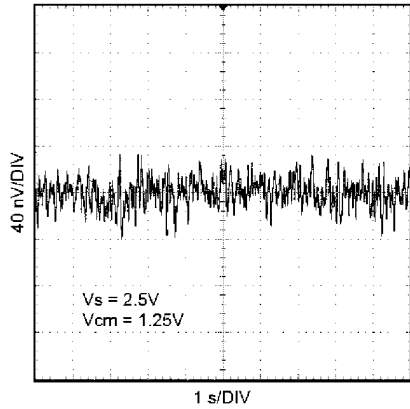

30015067

Time Domain Voltage Noise

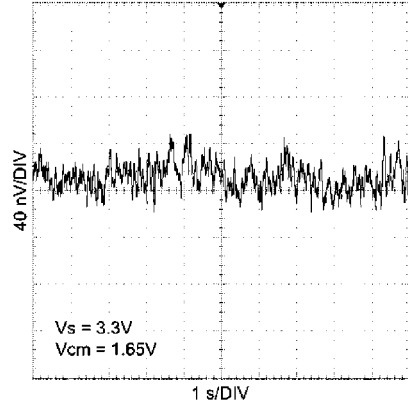

30015065

Time Domain Voltage Noise

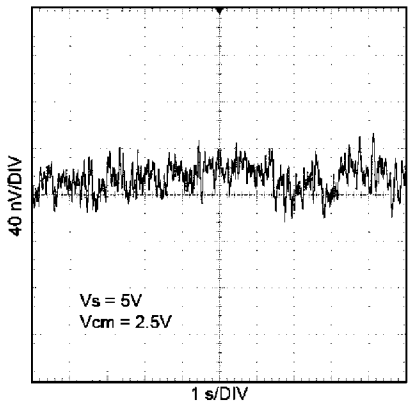

30015066

Output Voltage vs. Output Current

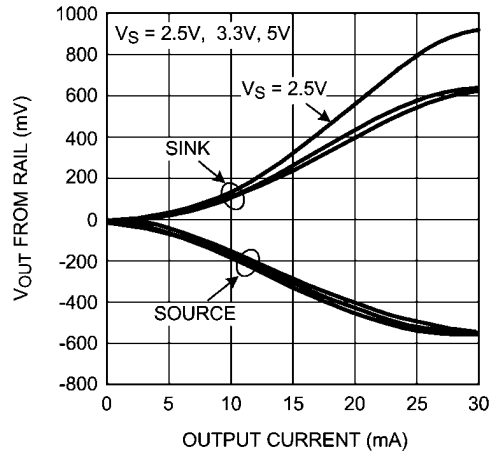

30015057

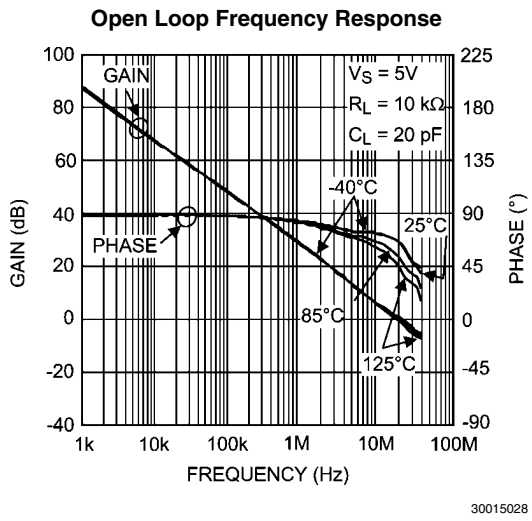
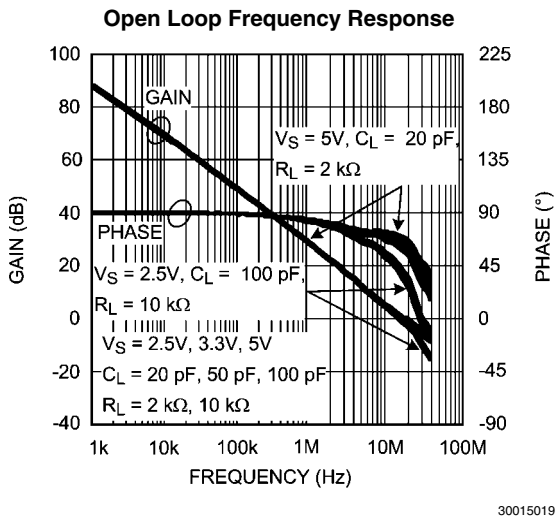
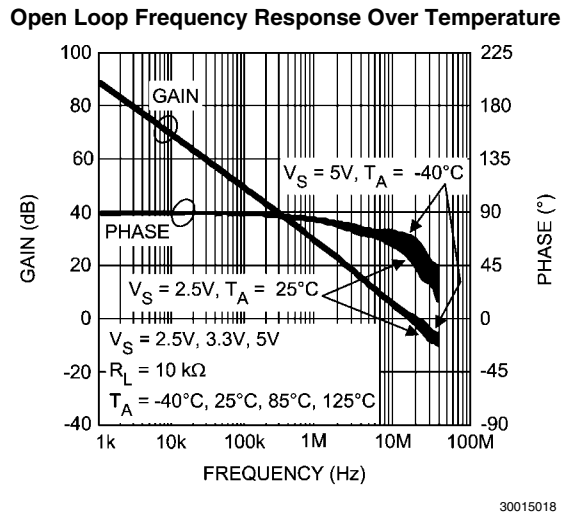
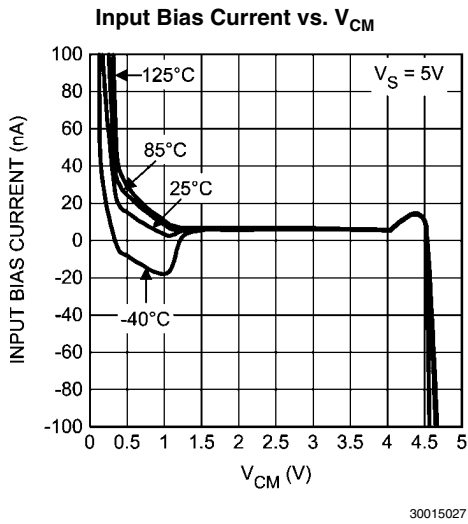
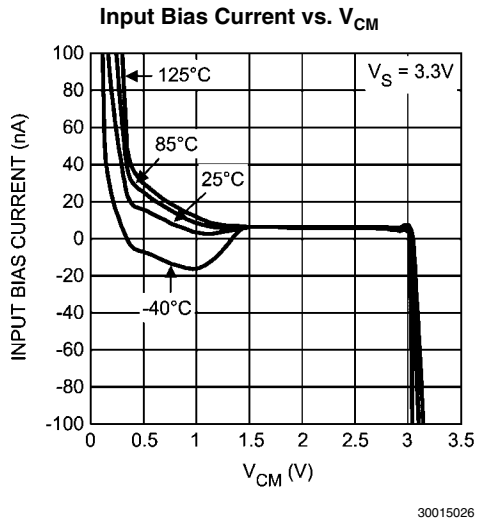
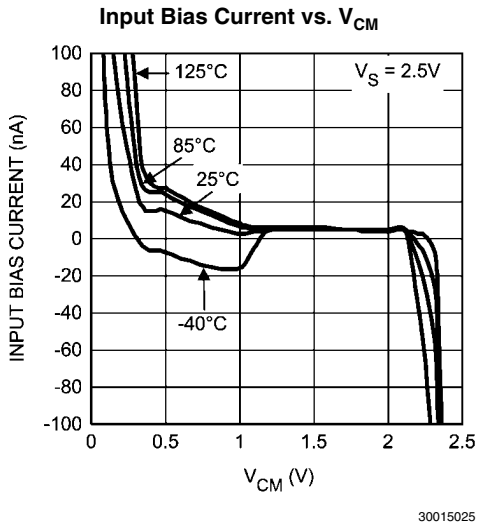

THD+N vs. Frequency

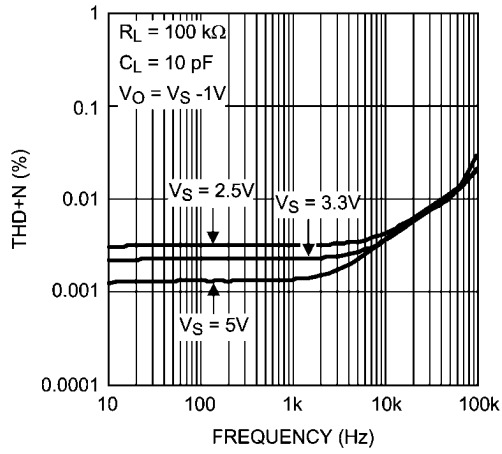

30015085

THD+N vs. Output Voltage

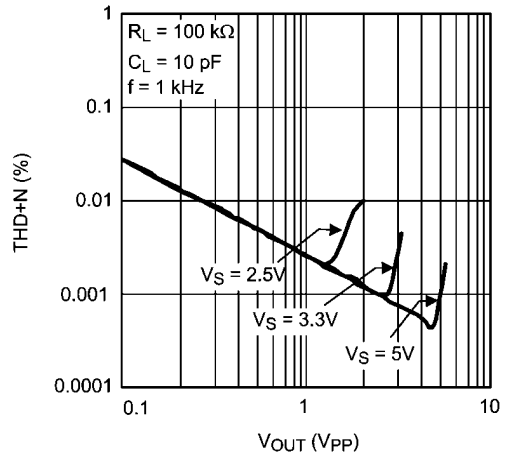

30015069

Large Signal Step Response

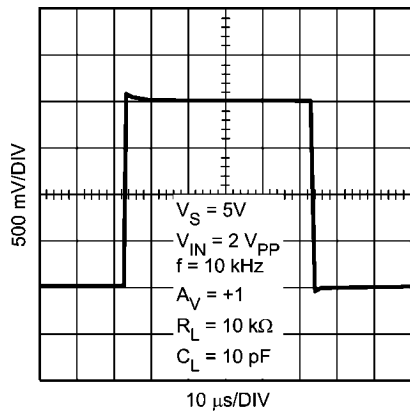

30015022

Small Signal Step Response

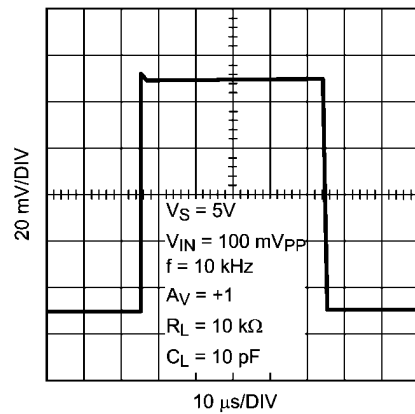

30015021

Large Signal Step Response

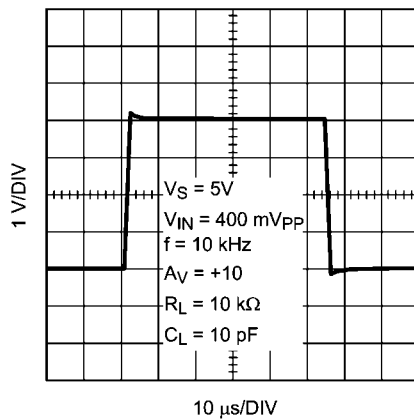

30015024

Small Signal Step Response

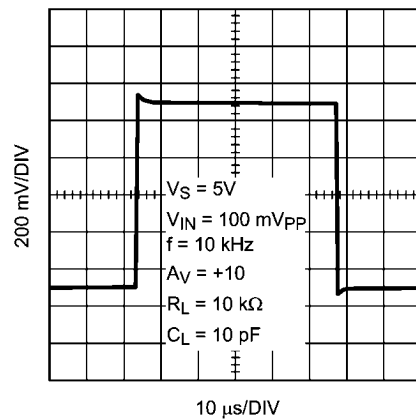

30015023

Supply Current vs. Supply Voltage

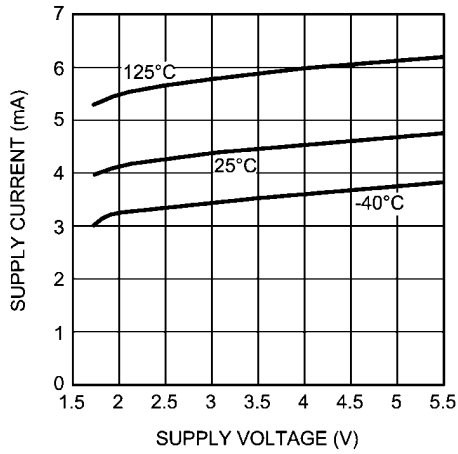

30015081

Output Swing High vs. Supply Voltage

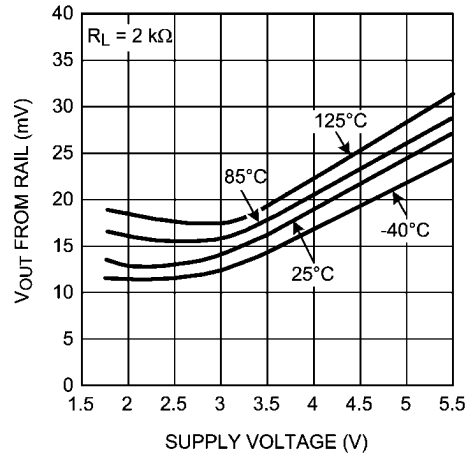

30015058

Output Swing Low vs. Supply Voltage

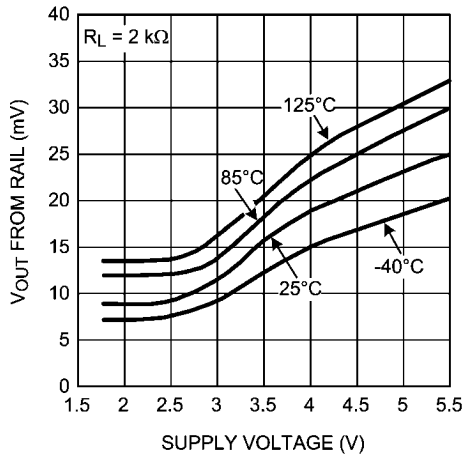

30015059

Sinking Current vs. Supply Voltage

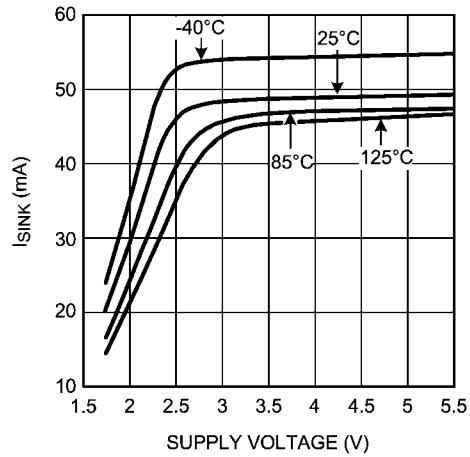

30015060

Sourcing Current vs. Supply Voltage

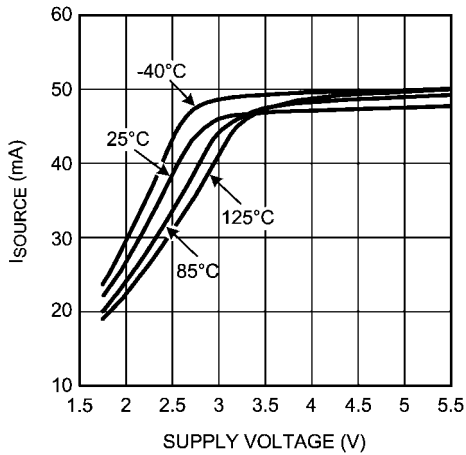

30015061

Application Notes

LMP7732

The LMP7732 is a dual low noise, low offset voltage, rail-to-rail input and output, low voltage precision amplifier.

The low input voltage noise of only $2.9 \text{ nV}/\sqrt{\text{Hz}}$ with a $1/f$ corner at 3 Hz makes the LMP7732 ideal for sensor applications where DC accuracy is of importance.

The LMP7732 has very low guaranteed offset voltage of only $\pm 40 \text{ } \mu\text{V}$. This low offset voltage along with the very low input voltage noise allows higher signal integrity and higher signal to noise ratios since the error contribution by the amplifier is at a minimum.

The LMP7732 has high gain bandwidth of 22 MHz. This wide bandwidth enables the use of the amplifier at higher gain settings while retaining ample usable bandwidth for the application. This is particularly beneficial when system designers need to use sensors with very limited output voltage range as it allows larger gains in one stage which in turn increases signal to noise ratio.

The LMP7732 has a proprietary input bias cancellation circuitry on the input stages. This allows the LMP7732 to have only about 1.5 nA bias current with a bipolar input stage. This low input bias current, paired with the inherent lower input voltage noise of bipolar input stages makes the LMP7732 an excellent choice for precision applications. The combination of low input bias current, low input offset voltage, and low input voltage noise enables the user to achieve unprecedented accuracy and higher signal integrity.

National Semiconductor is heavily committed to precision amplifiers and the market segment they serve. Technical support and extensive characterization data is available for sensitive applications or applications with a constrained error budget.

The LMP7732 comes in the 8-pin SOIC package. This small package is an ideal solution for area constrained PC boards and portable electronics.

INPUT BIAS CURRENT CANCELLATION

The LMP7732 has proprietary input bias current cancellation circuitry on its input stage.

The LMP7732 has rail-to-rail input. This is achieved by having a p-input and n-input stage in parallel. *Figure 1* only shows

one of the input stages as the circuitry is symmetrical for both stages.

Figure 1 shows that as the common mode voltage gets closer to one of the extreme ends, current I_1 significantly increases. This increased current shows as an increase in voltage drop across resistor R_1 equal to $I_1 \cdot R_1$ on IN^+ of the amplifier. This voltage contributes to the offset voltage of the amplifier. When common mode voltage is in the mid-range, the transistors are operating in the linear region and I_1 is significantly small. The voltage drop due to I_1 across R_1 can be ignored as it is orders of magnitude smaller than the amplifier's input offset voltage. As the common mode voltage gets closer to one of the rails, the offset voltage generated due to I_1 increases and becomes comparable to the amplifiers offset voltage.

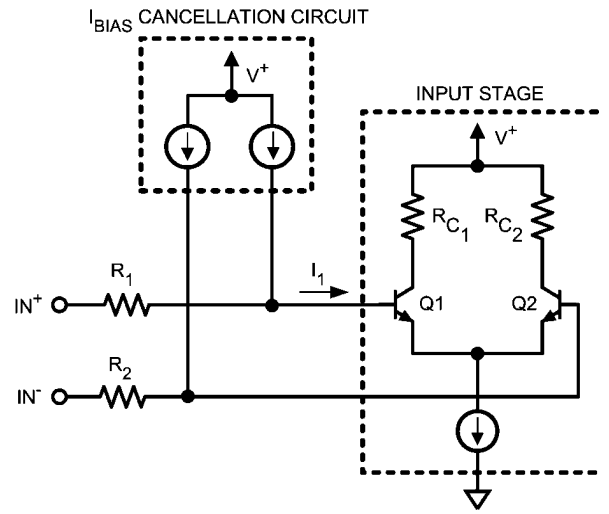

30015006

FIGURE 1. Input Bias Current Cancellation

INPUT VOLTAGE NOISE MEASUREMENT

The LMP7732 has very low input voltage noise. The peak-to-peak input voltage noise of the LMP7732 can be measured using the test circuit shown in *Figure 2*

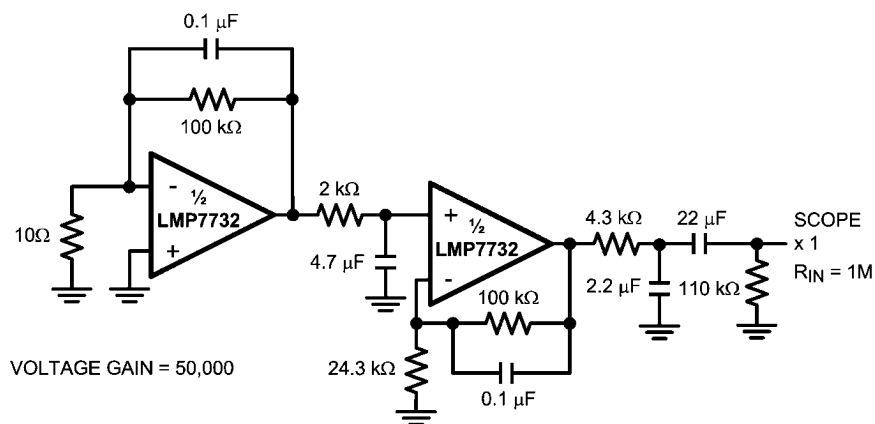

30015079

FIGURE 2. 0.1 Hz to 10 Hz Noise Test Circuit

The frequency response of this noise test circuit at the 0.1 Hz corner is defined by only one zero. The test time for the 0.1 Hz to 10 Hz noise measurement using this configuration should not exceed 10 seconds, as this time limit acts as an additional zero to reduce or eliminate the contributions of noise from frequencies below 0.1 Hz.

Figure 3 shows typical peak-to-peak noise for the LMP7732 measured with the circuit in Figure 2.

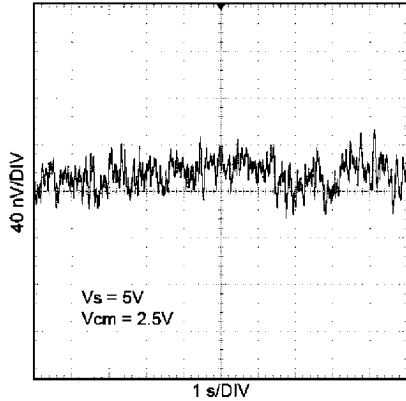

30015066

FIGURE 3. 0.1 Hz to 10 Hz Input Voltage Noise

Measuring the very low peak-to-peak noise performance of the LMP7732, requires special testing attention. In order to achieve accurate results, the device should be warmed up for at least five minutes. This is so that the input offset voltage of the op amp settles to a value. During this warm up period, the offset can typically change by a few μV because the chip temperature increases by about 30°C . If the 10 seconds of the measurement is selected to include this warm up time, some of this temperature change might show up as the measured noise. Figure 4 shows the start-up drift of five typical LMP7732 units.

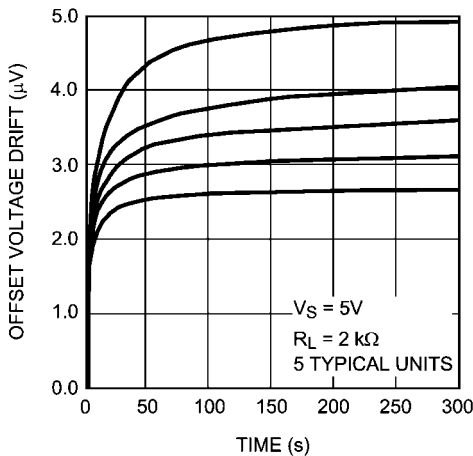

30015080

FIGURE 4. Start-Up Input Offset Voltage Drift

During the peak-to-peak noise measurement, the LMP7732 must be shielded. This prevents offset variations due to airflow. Offset can vary by a few nV due to this airflow and that can invalidate measurements of input voltage noise with a magnitude which is in the same range. For similar reasons, sudden motions must also be restricted in the vicinity of the test area. The feed-through which results from this motion could increase the observed noise value which in turn would invalidate the measurement.

DIODES BETWEEN THE INPUTS

The LMP7732 has a set of anti-parallel diodes between their input pins, as shown in Figure 5. These diodes are present to protect the input stage of the amplifiers. At the same time, they limit the amount of differential input voltage that is allowed on the input pins. A differential signal larger than the voltage needed to turn on the diodes might cause damage to the diodes. The differential voltage between the input pins should be limited to ± 3 diode drops or the input current needs to be limited to ± 20 mA.

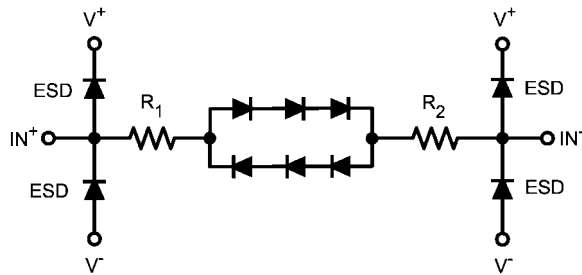

30015004

FIGURE 5. Anti-Parallel Diodes between Inputs

DRIVING AN ADC

Analog to Digital Converters, ADCs, usually have a sampling capacitor on their input. When the ADC's input is directly connected to the output of the amplifier a charging current flows from the amplifier to the ADC. This charging current causes a momentary glitch that can take some time to settle. There are different ways to minimize this effect. One way is to slow down the sampling rate. This method gives the amplifier sufficient time to stabilize its output. Another way to minimize the glitch, caused by the switch capacitor, is to have an external capacitor connected to the input of the ADC. This capacitor is chosen so that its value is much larger than the internal switching capacitor and it will hence provide the charge needed to quickly and smoothly charge the ADC's sampling capacitor. Since this large capacitor will be loading the output of the amplifier as well, an isolation resistor is needed between the output of the amplifier and this capacitor. The isolation resistor, R_{ISO} , separates the additional load capacitance from the output of the amplifier and will also form a low-pass filter and can be designed to provide noise reduction as well as anti-aliasing. The draw back of having R_{ISO} is that it reduces signal swing since there is some voltage drop across it.

Figure 6 (a) shows the ADC directly connected to the amplifier. To minimize the glitch in this setting, a slower sample rate needs to be used. Figure 6 (b) shows R_{ISO} and an external capacitor used to minimize the glitch.

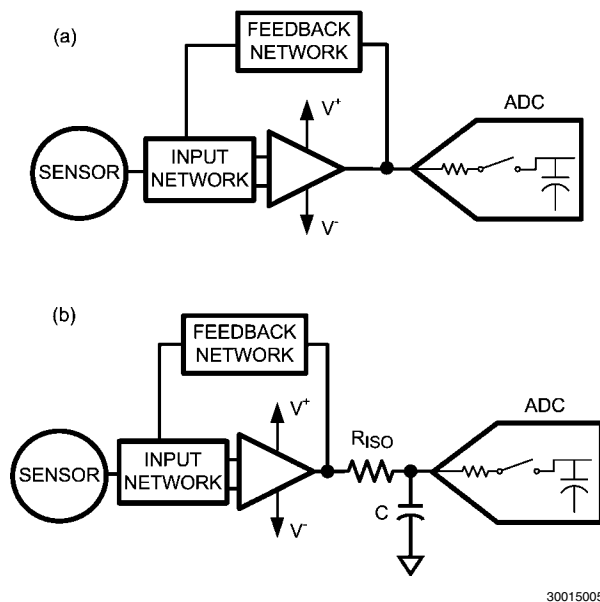

FIGURE 6. Driving An ADC

THERMOPILE AMPLIFIER

Thermopile Sensors

Thermopiles are arrays of interconnected thermocouples which can detect surface temperature of an object through radiation rather than direct contact. The hot and cold junctions of the thermocouples are thermally isolated. The hot junctions are exposed to IR radiation emitted from the measurement surface and the cold junctions are connected to a heat sink. The incident IR changes the temperature of the hot junctions of the thermopile and produces an output voltage proportional to this change.

The hot junction of the thermopile is covered with a highly emissive coating. The IR radiation incident to this highly emissive material changes the temperature of this coating. The temperature change is converted to a voltage by the thermopile. Emissivity represents the radiation or absorption efficiency of a material relative to a black body. An ideal black body has an emissivity of 1.0. Excluding shiny metals, most objects have emissivities above 0.85. As a practical matter, shiny metals are not good candidates for IR sensing because of their low emissivity. The low emissivity means that the material is highly reflective. Reflective materials often "reflect" the surrounding environment's temperature rather than their own heat radiation. This makes them not suitable for thermopile applications.

The output voltage of a thermopile is related to temperature and emissivity by the following formula:

$$V_{OUT} = K \left(\epsilon_{OBJ} \cdot T_{OBJ}^{4-\delta} - \epsilon_{TP} \cdot T_{TP}^{4-\delta} \right)$$

Where:

V_{OUT} : Output voltage of the thermopile

K : Proportionality constant

ϵ_{OBJ} : Emissivity of object being measured

T_{OBJ} : Temperature of object being measured

δ : Correction factor. This is needed since thermopile filters do not allow all wavelengths to enter the sensor

ϵ_{TP} : Emissivity of the thermopile

T_{TP} : Temperature of the thermopile

As mentioned above, the IR radiation generates a static voltage across the pyroelectric material. If the illumination is constant, the signal level detection declines. This is why the radiation needs to be periodically refreshed. This task is usually achieved by the means of a mechanical chopper in front of the detector.

Thermopiles offer much faster response time compared to other temperature measurement devices. Packaged thermistors and thermocouples have response times that can range up to a few seconds, where as packaged thermopiles can easily achieve response times in the order of tens of milliseconds. Thermopiles also provide superior thermal isolation compared to their contact temperature measurement counterparts. Physical contact disturbs the systems temperature and also creates temperature gradients.

Figure 7 shows a simplified schematic of a thermopile. The cold junctions are connected to a heat sink, and the absorber material covers the hot junction. The output voltage resulting from temperature difference between the two junctions is measured at the two ends of the array of thermocouples. As is evident in Figure 7, increasing the number of thermocouples in a thermopile increases the output voltage range. This also increases the active area of the thermopile sensor.

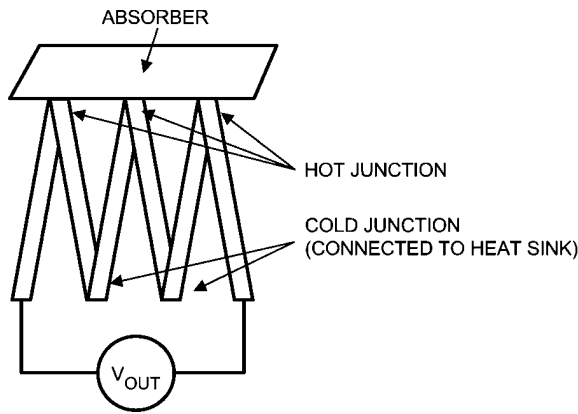

30015007

FIGURE 7. Thermopile

Thermopiles have very wide temperature ranges of -100°C to 1000°C

When choosing a thermopile for a certain application, one must pay attention to several parameters. Some of these parameters are discussed below:

Thermopiles' sensitivity, or responsivity, is determined by the ratio of output voltage to the absorbed input signal power and is usually specified in V/W . Typical sensitivity of thermopiles ranges from 10s of V/W to about 100 V/W . Generally, higher values of sensitivity are desirable. Sensitivity is dependent on the absorber's area and number of thermocouples used in the sensor. Sensitivity is often represented by S where:

$$S = V_{\text{OUT}}/P_{\text{IN}}$$

The sensitivity of a thermopile changes with change in temperature. This change is usually specified as the Temperature Coefficient, TC, of sensitivity. Lower numbers are desired for this parameter.

Resistance of the thermopile is usually specified in the datasheet. This is the impedance which will be seen by the input of the amplifier used to process the thermopile's output signal. Typical values for thermopile resistance, R_{TP} , range from 10s of kilo-ohms to about 100 $\text{k}\Omega$. This resistance is also a function of temperature. The temperature coefficient of the resistance is usually specified in a thermopile's datasheet. As with any other parameter, minimum variation with temperature is desired.

The dominant noise source for a thermopile is its resistance. Noise spectral density of a resistor is calculated by:

$$\sqrt{4kRT}$$

Where k is the Boltzman constant and T is absolute temperature. Unit of noise spectral density is: $\text{V}/\sqrt{\text{Hz}}$

For the thermopile sensor, this noise is usually represented by V_{NOISE} where:

$$V_{\text{NOISE}} = \sqrt{4kR_{\text{TP}}T}$$

Typical values for this voltage noise are in the order of a few tens of $\text{nV}/\sqrt{\text{Hz}}$.

The Noise Equivalent Power, NEP, is often used to specify the minimum detectable signal level per square root band-

width. A smaller NEP is desired, however NEP is dependent on the thermopile active area, A_D . For a thermopile:

$$S = \frac{V_{\text{OUT}}}{P_{\text{IN}}} = \frac{V_{\text{OUT}}}{\vec{E} \cdot A_D}$$

And

$$\text{NEP} = \frac{V_{\text{NOISE}}}{S} = \frac{V_{\text{NOISE}} \cdot \vec{E} \cdot A_D}{V_{\text{OUT}}}$$

As it is shown above, one cannot just compare the NEP of two thermopiles without considering the corresponding active areas.

A better way to compare thermopiles is to look at their specific detectivity, D^* . Specific detectivity includes both the device noise and its sensitivity. It is normalized with respect to the detector's active area and also noise bandwidth. D^* is given by:

$$D^* = \frac{S \times \sqrt{A_D}}{V_{\text{NOISE}}} = \frac{\sqrt{A_D}}{\text{NEP}}$$

Unit of D^* is $\text{cm}\sqrt{\text{Hz}}/\text{W}$. Typical values for specific detectivity range from 10^8 to $3 \times 10^8 \text{ cm}\sqrt{\text{Hz}}/\text{W}$.

After receiving radiation, the thermopile takes some time before it comes to thermal equilibrium. The time it takes for the sensor to achieve this equilibrium is called response time or time constant of the sensor. Clearly, lower time constants are very desirable.

Precision Amplifier

Since the output of thermopiles are usually very small and at most in the order of only a few millivolts, the first part of the signal conditioning path should involve amplification. In choosing an amplifier for this purpose, a few different sensor characteristics and the way they interface with the amplifier should be considered. These are:

Sensor's Impedance and Opamp's Input Bias Current

The input bias current causes a voltage drop across the sensor and the amount of this voltage is equal to the sensor's impedance multiplied by the magnitude of bias current. The higher the sensor's input impedance, the more accentuated the effect of amplifier's input bias current will be. For very high impedance sensors, it is imperative that opamps with very low input bias currents be used. Thermopiles have input impedances in the range of 100 $\text{k}\Omega$, so input bias current is not as critical as in some other applications.

Sensor's output voltage range:

The output signal of the sensor is fed into the opamp where it will be amplified or otherwise conditioned, (e.g. level shifted, buffered.) It is important to pay attention to different parameters of this output signal.

One important aspect is the lowest expected level of the sensor's output and compare that with different parameters contributing to the amplifier's total input noise. If the sensor's output level is in the same order of magnitude or smaller than the opamp's total input noise, then signal integrity at the opamp's output and the ADC's input will be compromised.

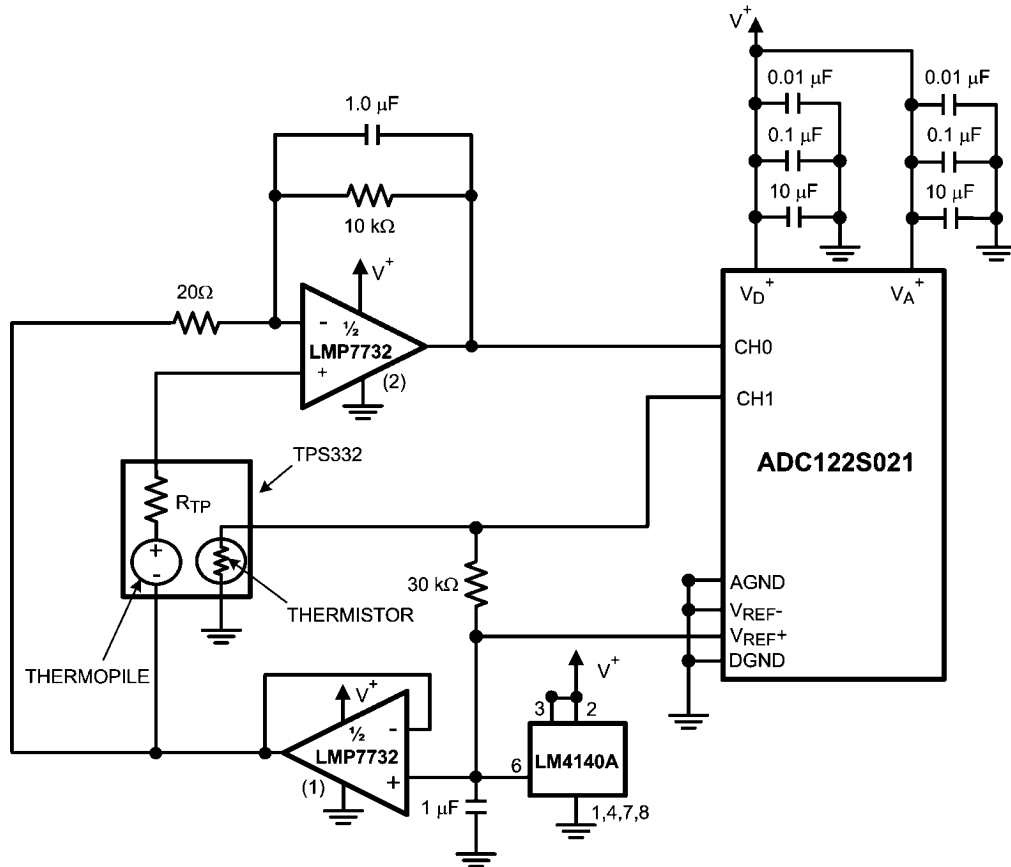

30015078

FIGURE 8. Thermopile Amplifier

Figure 8 shows the LMP7732 used as a thermopile amplifier. The LMP7732 is a great choice for use with thermopile sensors. The LMP7732 provides unprecedented accuracy and precision because of its very low input voltage noise and the very low $1/f$ corner frequency. The $1/f$ noise is one of the main sources of error in DC operating mode. Since thermopiles and most other sensors operate on DC signals, signal integrity at the DC level is very important. The LMP7732 also has very low offset voltage and offset voltage drift which greatly reduces the effects of input offset voltage of the amplifier on the thermopile signal. The thermopile used in this circuit is TPS332 from PerkinElmer Optoelectronics, PKI. This thermopile has an internal resistance, R_{TP} , of 75 k Ω . The output voltage of the thermopile is represented with a DC voltage source. The TPS332 has a thermistor integrated in the package. The thermistor is used to measure the ambient temperature of the thermopile at the time of measurement. The thermistor's resistance at room temperature is 30 k Ω . More information about this thermopile and other sensors from PKI can be found on <http://www.perkinelmer.com/>

The circuit in Figure 8 shows how the LMP7732 is connected to the thermopile. This circuit is comprised of two LMP7732 amplifiers, the LM4140A-2.5 which is a precision voltage reference, the ADC122S021 which is a two channel Analog to Digital converter, and the thermopile sensor. Note that the two amplifiers used in this circuit are numbered for ease of refer-

ence. The LMP7732 amplifiers are referred to as amplifier 1 and amplifier 2 per Figure 8.

In Figure 8 the LM4140A is providing a precision voltage reference of 2.5V. This reference voltage is applied to the thermistor via the 30 k Ω resistor. The thermistor's resistance is converted to a voltage using this set up. This voltage is fed into the ADC's channel one. The ADC uses this voltage and the thermistor's look up table to convert this voltage to temperature. The 2.5V reference is also fed into amplifier 1, which is configured as a buffer. This LMP7732 transfers the 2.5V signal to both inputs of amplifier 2. This means the 2.5V will show up on the output of amplifier 2. Having an output level that is mid-supply is important since the thermopile sensor has a bipolar output signal and this way the amplifier can accurately gain the thermopile voltage, whether its polarity is positive or negative. It is also important because the output signal of amplifier 2 is only positive. ADCs can only handle positive signals on their inputs. Amplifier 2 is used to gain and filter the thermopile signal. The low pass filter ensures that AC noise will not be gained up and, as a result, the output signal will be cleaner. The output of amplifier 2 is fed into the ADC's channel 0. The ADC uses the ambient temperature, which was calculated using the voltage on Channel 1 and the thermistor's look up table, along with the thermopiles' gained output voltage available on channel 0 and the thermopile's look up table to determine the object's temperature.

Physical Dimensions inches (millimeters) unless otherwise noted

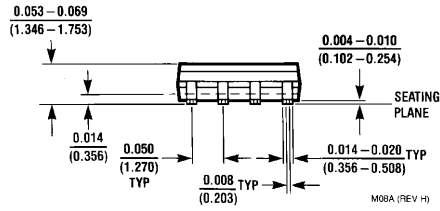
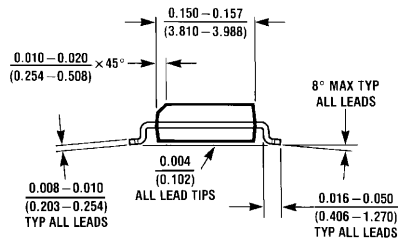
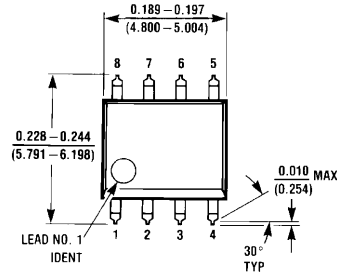

8-Pin SOIC
NS Package Number M08A

M08A (REV H)

Notes

THE CONTENTS OF THIS DOCUMENT ARE PROVIDED IN CONNECTION WITH NATIONAL SEMICONDUCTOR CORPORATION ("NATIONAL") PRODUCTS. NATIONAL MAKES NO REPRESENTATIONS OR WARRANTIES WITH RESPECT TO THE ACCURACY OR COMPLETENESS OF THE CONTENTS OF THIS PUBLICATION AND RESERVES THE RIGHT TO MAKE CHANGES TO SPECIFICATIONS AND PRODUCT DESCRIPTIONS AT ANY TIME WITHOUT NOTICE. NO LICENSE, WHETHER EXPRESS, IMPLIED, ARISING BY ESTOPPEL OR OTHERWISE, TO ANY INTELLECTUAL PROPERTY RIGHTS IS GRANTED BY THIS DOCUMENT.

TESTING AND OTHER QUALITY CONTROLS ARE USED TO THE EXTENT NATIONAL DEEMS NECESSARY TO SUPPORT NATIONAL'S PRODUCT WARRANTY. EXCEPT WHERE MANDATED BY GOVERNMENT REQUIREMENTS, TESTING OF ALL PARAMETERS OF EACH PRODUCT IS NOT NECESSARILY PERFORMED. NATIONAL ASSUMES NO LIABILITY FOR APPLICATIONS ASSISTANCE OR BUYER PRODUCT DESIGN. BUYERS ARE RESPONSIBLE FOR THEIR PRODUCTS AND APPLICATIONS USING NATIONAL COMPONENTS. PRIOR TO USING OR DISTRIBUTING ANY PRODUCTS THAT INCLUDE NATIONAL COMPONENTS, BUYERS SHOULD PROVIDE ADEQUATE DESIGN, TESTING AND OPERATING SAFEGUARDS.

EXCEPT AS PROVIDED IN NATIONAL'S TERMS AND CONDITIONS OF SALE FOR SUCH PRODUCTS, NATIONAL ASSUMES NO LIABILITY WHATSOEVER, AND NATIONAL DISCLAIMS ANY EXPRESS OR IMPLIED WARRANTY RELATING TO THE SALE AND/OR USE OF NATIONAL PRODUCTS INCLUDING LIABILITY OR WARRANTIES RELATING TO FITNESS FOR A PARTICULAR PURPOSE, MERCHANTABILITY, OR INFRINGEMENT OF ANY PATENT, COPYRIGHT OR OTHER INTELLECTUAL PROPERTY RIGHT.

LIFE SUPPORT POLICY

NATIONAL'S PRODUCTS ARE NOT AUTHORIZED FOR USE AS CRITICAL COMPONENTS IN LIFE SUPPORT DEVICES OR SYSTEMS WITHOUT THE EXPRESS PRIOR WRITTEN APPROVAL OF THE CHIEF EXECUTIVE OFFICER AND GENERAL COUNSEL OF NATIONAL SEMICONDUCTOR CORPORATION. As used herein:

Life support devices or systems are devices which (a) are intended for surgical implant into the body, or (b) support or sustain life and whose failure to perform when properly used in accordance with instructions for use provided in the labeling can be reasonably expected to result in a significant injury to the user. A critical component is any component in a life support device or system whose failure to perform can be reasonably expected to cause the failure of the life support device or system or to affect its safety or effectiveness.

National Semiconductor and the National Semiconductor logo are registered trademarks of National Semiconductor Corporation. All other brand or product names may be trademarks or registered trademarks of their respective holders.

Copyright© 2007 National Semiconductor Corporation

For the most current product information visit us at www.national.com



National Semiconductor Americas Customer Support Center
 Email: new.feedback@nsc.com
 Tel: 1-800-272-9959

National Semiconductor Europe Customer Support Center
 Fax: +49 (0) 180-530-85-86
 Email: europe.support@nsc.com
 Deutsch Tel: +49 (0) 69 9508 6208
 English Tel: +49 (0) 870 24 0 2171
 Français Tel: +33 (0) 1 41 91 8790

National Semiconductor Asia Pacific Customer Support Center
 Email: ap.support@nsc.com

National Semiconductor Japan Customer Support Center
 Fax: 81-3-5639-7507
 Email: jpn.feedback@nsc.com
 Tel: 81-3-5639-7560