

Operational Amplifiers

Low Supply Current Output Full Swing Operational Amplifiers

LMR821G LMR822xxx LMR824xxx

General Description

LMR821G, LMR822xxx, and LMR824xxx are low-voltage low-current full-swing operational amplifiers. These products exhibit high voltage gain and high slew rate, making them suitable for mobile equipment, low voltage application and active filters.

Features

- Low Operating Supply Voltage
- Output Full Swing
- High Large Signal Voltage Gain
- High Slew Rate
- Low Supply Current

Applications

- Mobile Equipment
- Low Voltage Application
- Active Filter
- Buffer
- Consumer Electronics

Key Specifications

- Operating Supply Voltage (Single Supply): +2.5V to +5.5V
- Voltage Gain (R_L=600Ω): 105dB (Typ)
- Temperature Range: -40°C to +85°C
- Slew Rate: 2.0V/μs (Typ)
- Input Offset Voltage:
 - LMR821G 3.5mV (Max)
 - LMR822xxx 5mV (Max)
 - LMR824xxx 5mV (Max)
- Input Bias Current: 30nA (Typ)

Packages

| | W(Typ) x D(Typ) x H(Max) |
|------------|--------------------------|
| SSOP5 | 2.90mm x 2.80mm x 1.25mm |
| SOP8 | 5.00mm x 6.20mm x 1.71mm |
| SOP-J8 | 4.90mm x 6.00mm x 1.65mm |
| SSOP-B8 | 3.00mm x 6.40mm x 1.35mm |
| TSSOP-B8 | 3.00mm x 6.40mm x 1.20mm |
| MSOP8 | 2.90mm x 4.00mm x 0.90mm |
| TSSOP-B8J | 3.00mm x 4.90mm x 1.10mm |
| SOP14 | 8.70mm x 6.20mm x 1.71mm |
| SOP-J14 | 8.65mm x 6.00mm x 1.65mm |
| TSSOP-B14J | 5.00mm x 6.40mm x 1.20mm |

Pin Configuration

LMR821G : SSOP5

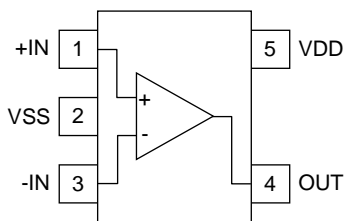

| Pin No. | Pin Name |
|---------|----------|
| 1 | +IN |
| 2 | VSS |
| 3 | -IN |
| 4 | OUT |
| 5 | VDD |

- LMR822F : SOP8
- LMR822FJ : SOP-J8
- LMR822FV : SSOP-B8
- LMR822FVT : TSSOP-B8
- LMR822FVM : MSOP8
- LMR822FVJ : TSSOP-B8J

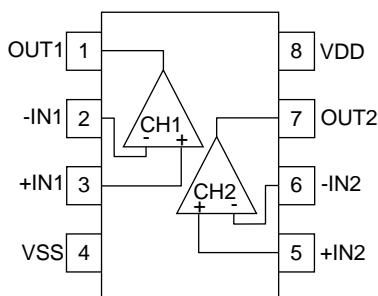

| Pin No. | Pin Name |
|---------|----------|
| 1 | OUT1 |
| 2 | -IN1 |
| 3 | +IN1 |
| 4 | VSS |
| 5 | +IN2 |
| 6 | -IN2 |
| 7 | OUT2 |
| 8 | VDD |

○Product structure : Silicon monolithic integrated circuit ○This product has no designed protection against radioactive rays.

LMR824F : SOP14
 LMR824FJ : SOP-J14
 LMR824FVJ : TSSOP-B14J

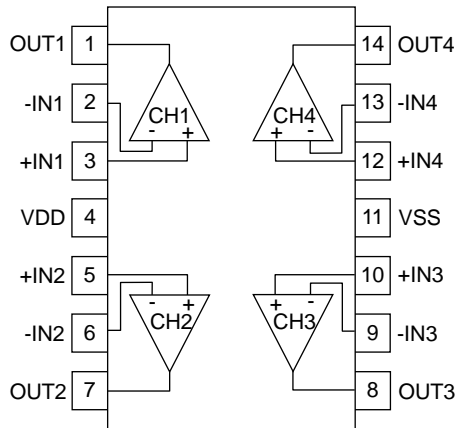

| Pin No. | Pin Name |
|---------|----------|
| 1 | OUT1 |
| 2 | -IN1 |
| 3 | +IN1 |
| 4 | VDD |
| 5 | +IN2 |
| 6 | -IN2 |
| 7 | OUT2 |
| 8 | OUT3 |
| 9 | -IN3 |
| 10 | +IN3 |
| 11 | VSS |
| 12 | +IN4 |
| 13 | -IN4 |
| 14 | OUT4 |

Ordering Information

| | | |
|-------------------|---|-----|
| L M R 8 2 x x x x | - | x x |
|-------------------|---|-----|

| | |
|-------------|-----------------|
| Part Number | Package |
| LMR821G | G : SSOP5 |
| LMR822F | F : SOP8 |
| LMR822FJ | : SOP14 |
| LMR822FV | FJ : SOP-J8 |
| LMR822FVT | : SOP-J14 |
| LMR822FVM | FV : SSOP-B8 |
| LMR822FVJ | FVT : TSSOP-B8 |
| LMR824F | FVM : MSOP8 |
| LMR824FJ | FVJ : TSSOP-B8J |
| LMR824FVJ | : TSSOP-B14J |

| |
|---|
| Packaging and forming specification TR: Embossed tape and reel (SSOP5/MSOP8) E2: Embossed tape and reel (SOP8/SOP-J8/SSOP-B8/TSSOP-B8/ TSSOP-B8J/SOP14/SOP-J14/TSSOP-B14J) |
|---|

Line-up

| Topr | Channels | Package | | Orderable Part Number |
|----------------|----------|------------|--------------|-----------------------|
| -40°C to +85°C | 1ch | SSOP5 | Reel of 3000 | LMR821G-TR |
| | 2ch | SOP8 | Reel of 2500 | LMR822F-E2 |
| | | SOP-J8 | Reel of 2500 | LMR822FJ-E2 |
| | | SSOP-B8 | Reel of 2500 | LMR822FV-E2 |
| | | TSSOP-B8 | Reel of 3000 | LMR822FVT-E2 |
| | | MSOP8 | Reel of 3000 | LMR822FVM-TR |
| | | TSSOP-B8J | Reel of 2500 | LMR822FVJ-E2 |
| | 4ch | SOP14 | Reel of 2500 | LMR824F-E2 |
| | | SOP-J14 | Reel of 2500 | LMR824FJ-E2 |
| | | TSSOP-B14J | Reel of 2500 | LMR824FVJ-E2 |

Absolute Maximum Ratings (T_A=25°C)

| Parameter | Symbol | Ratings | | | Unit | |
|--|----------------------------------|--|----------------------------|----------------------------|----------------------------|---|
| | | LMR821G | LMR822xxx | LMR824xxx | | |
| Supply Voltage | V _{DD} -V _{SS} | +7 | | | V | |
| Power Dissipation | Pd | SSOP5 | 0.67 ^(Note 1,8) | - | - | W |
| | | SOP8 | - | 0.68 ^(Note 2,8) | - | |
| | | SOP-J8 | - | 0.67 ^(Note 1,8) | - | |
| | | SSOP-B8 | - | 0.62 ^(Note 3,8) | - | |
| | | TSSOP-B8 | - | 0.62 ^(Note 3,8) | - | |
| | | MSOP8 | - | 0.58 ^(Note 4,8) | - | |
| | | TSSOP-B8J | - | 0.58 ^(Note 4,8) | - | |
| | | SOP14 | - | - | 0.56 ^(Note 5,8) | |
| | | SOP-J14 | - | - | 1.02 ^(Note 6,8) | |
| | TSSOP-B14J | - | - | 0.84 ^(Note 7,8) | | |
| Differential Input Voltage ^(Note 9) | V _{ID} | V _{DD} - V _{SS} | | | V | |
| Input Common-mode Voltage Range | V _{ICM} | (V _{SS} - 0.3) to (V _{DD} + 0.3) | | | V | |
| Input Current ^(Note 10) | I _I | ±10 | | | mA | |
| Operating Supply Voltage | V _{opr} | +2.5 to +5.5 | | | V | |
| Operating Temperature | Topr | - 40 to +85 | | | °C | |
| Storage Temperature | Tstg | - 55 to +150 | | | °C | |
| Maximum Junction Temperature | Tjmax | +150 | | | °C | |

(Note 1) Pd is reduced by 5.4mW/°C above T_A= 25°C.

(Note 2) Pd is reduced by 5.5mW/°C above T_A= 25°C.

(Note 3) Pd is reduced by 5.0mW/°C above T_A= 25°C.

(Note 4) Pd is reduced by 4.7mW/°C above T_A= 25°C.

(Note 5) Pd is reduced by 4.5mW/°C above T_A= 25°C.

(Note 6) Pd is reduced by 8.2mW/°C above T_A= 25°C.

(Note 7) Pd is reduced by 6.8mW/°C above T_A= 25°C.

(Note 8) Mounted on an FR4 glass epoxy PCB 70mmx70mmx1.6mm (Copper foil area less than 3%).

(Note 9) Differential Input Voltage is the voltage difference between the inverting and non-inverting inputs. The input pin voltage is set to more than V_{SS}.

(Note 10) An excessive input current will flow when input voltages of more than V_{DD}+0.6V or less than V_{SS}-0.6V are applied. The input current can be set to less than the rated current by adding a limiting resistor.

Caution: Operating the IC over the absolute maximum ratings may damage the IC. The damage can either be a short circuit between pins or an open circuit between pins and the internal circuitry. Therefore, it is important to consider circuit protection measures, such as adding a fuse, in case the IC is operated over the absolute maximum ratings.

Electrical Characteristics

OLMR821G (Unless otherwise specified $V_{DD}=+2.5V$, $V_{SS}=0V$)

| Parameter | Symbol | Temperature Range | Limits | | | Unit | Conditions |
|---|----------|-------------------|--------|------|-----|------|--------------------------------------|
| | | | Min | Typ | Max | | |
| Input Offset Voltage ^(Note 11) | V_{IO} | 25°C | - | 1 | 3.5 | mV | $V_{DD}=2.5V$ to 5.5V |
| | | Full Range | - | - | 4 | | |
| Maximum Output Voltage(High) | V_{OH} | 25°C | 2.30 | 2.37 | - | V | $R_L=600\Omega$ ^(Note 12) |
| | | | 2.40 | 2.46 | - | | $R_L=2k\Omega$ ^(Note 12) |
| Maximum Output Voltage(Low) | V_{OL} | 25°C | - | 130 | 200 | mV | $R_L=600\Omega$ ^(Note 12) |
| | | | - | 80 | 120 | | $R_L=2k\Omega$ ^(Note 12) |

(Note 11) Absolute value

(Note 12) Output load resistance connects to a half of V_{DD} .OLMR821G (Unless otherwise specified $V_{DD}=+2.7V$, $V_{SS}=0V$)

| Parameter | Symbol | Temperature Range | Limits | | | Unit | Conditions |
|--|--------------------------|-------------------|--------|------|-----|------------------|---|
| | | | Min | Typ | Max | | |
| Input Offset Voltage ^(Note 13,14) | V_{IO} | 25°C | - | 1 | 3.5 | mV | $V_{DD}=2.5V$ to 5.5V |
| | | Full Range | - | - | 4 | | |
| Input Offset Voltage Drift | $\Delta V_{IO}/\Delta T$ | 25°C | - | 1 | - | $\mu V/^\circ C$ | - |
| Input Offset Current ^(Note 13) | I_{IO} | 25°C | - | 0.5 | 30 | nA | - |
| Input Bias Current ^(Note 13) | I_B | 25°C | - | 30 | 90 | nA | - |
| Supply Current ^(Note 14) | I_{DD} | 25°C | - | 280 | 340 | μA | $A_V=0dB$, $V_{+IN}=1.35V$ |
| | | Full Range | - | - | 500 | | |
| Maximum Output Voltage(High) | V_{OH} | 25°C | 2.50 | 2.58 | - | V | $R_L=600\Omega$ ^(Note 16) |
| | | | 2.60 | 2.66 | - | | $R_L=2k\Omega$ ^(Note 16) |
| Maximum Output Voltage(Low) | V_{OL} | 25°C | - | 130 | 200 | mV | $R_L=600\Omega$ ^(Note 16) |
| | | | - | 80 | 120 | | $R_L=2k\Omega$ ^(Note 16) |
| Large Signal Voltage Gain | A_V | 25°C | - | 100 | - | dB | $R_L=600\Omega$ ^(Note 16) |
| | | | 95 | 100 | - | | $R_L=2k\Omega$ ^(Note 16) |
| Input Common-mode Voltage Range | V_{ICM} | 25°C | 0 | - | 1.8 | V | V_{SS} to ($V_{DD}-0.9V$) |
| Common-mode Rejection Ratio | CMRR | 25°C | 70 | 85 | - | dB | - |
| Power Supply Rejection Ratio | PSRR | 25°C | 75 | 85 | - | dB | $V_{DD}=2.7V$ to 5.5V $V_{ICM}=1V$ |
| Output Source Current ^(Note 15) | I_{SOURCE} | 25°C | 12 | 16 | - | mA | $V_{OUT}=0V$ Short Circuit Current |
| Output Sink Current ^(Note 15) | I_{SINK} | 25°C | 12 | 26 | - | mA | $V_{OUT}=2.7V$ Short Circuit Current |
| Slew Rate | SR | 25°C | - | 2.0 | - | V/ μs | $C_L=25pF$ |
| Gain Bandwidth | GBW | 25°C | - | 5.0 | - | MHz | $C_L=25pF$, $A_V=40dB$ $f=1MHz$ |
| Phase Margin | θ | 25°C | - | 50 | - | deg | $C_L=25pF$, $A_V=40dB$ |
| Gain Margin | GM | 25°C | - | 4.5 | - | dB | $C_L=25pF$, $A_V=40dB$ |
| Input Referred Noise Voltage | V_N | 25°C | - | 30 | - | nV/ \sqrt{Hz} | $f=1kHz$ |
| Total Harmonic Distortion + Noise | THD+N | 25°C | - | 0.01 | - | % | $V_{OUT}=2.2V_{P-P}$, $f=1kHz$ $R_L=10k\Omega$ $A_V=0dB$, DIN-AUDIO |

(Note 13) Absolute value

(Note 14) Full Range: $T_A=-40^\circ C$ to $+85^\circ C$

(Note 15) Consider the power dissipation of the IC under high temperature environment when selecting the output current value.

There may be a case where the output current value is reduced due to the rise in IC temperature caused by the heat generated inside the IC.

(Note 16) Output load resistance connects to a half of V_{DD} .

Electrical Characteristics - continued

OLMR821G (Unless otherwise specified $V_{DD}=+5.0V$, $V_{SS}=0V$)

| Parameter | Symbol | Temperature Range | Limits | | | Unit | Conditions |
|--|--------------------------|-------------------|--------|------|-----|------------------|---|
| | | | Min | Typ | Max | | |
| Input Offset Voltage ^(Note 17,18) | V_{IO} | 25°C | - | 1 | 3.5 | mV | $V_{DD}=2.5V$ to 5.5V |
| | | Full Range | - | - | 4 | | |
| Input Offset Voltage Drift | $\Delta V_{IO}/\Delta T$ | 25°C | - | 1 | - | $\mu V/^\circ C$ | - |
| Input Offset Current ^(Note 17) | I_{IO} | 25°C | - | 0.5 | 30 | nA | - |
| Input Bias Current ^(Note 17) | I_B | 25°C | - | 40 | 100 | nA | - |
| Supply Current ^(Note 18) | I_{DD} | 25°C | - | 325 | 425 | μA | $A_V=0dB$, $V_{+IN}=2.5V$ |
| | | Full Range | - | - | 600 | | |
| Maximum Output Voltage(High) | V_{OH} | 25°C | 4.75 | 4.84 | - | V | $R_L=600\Omega$ ^(Note 20) |
| | | | 4.85 | 4.90 | - | | $R_L=2k\Omega$ ^(Note 20) |
| Maximum Output Voltage(Low) | V_{OL} | 25°C | - | 170 | 250 | mV | $R_L=600\Omega$ ^(Note 20) |
| | | | - | 100 | 150 | | $R_L=2k\Omega$ ^(Note 20) |
| Large Signal Voltage Gain | A_V | 25°C | - | 105 | - | dB | $R_L=600\Omega$ ^(Note 20) |
| | | | 95 | 105 | - | | $R_L=2k\Omega$ ^(Note 20) |
| Input Common-mode Voltage Range | V_{ICM} | 25°C | 0 | - | 4.1 | V | V_{SS} to ($V_{DD}-0.9V$) |
| Common-mode Rejection Ratio | CMRR | 25°C | 72 | 90 | - | | - |
| Power Supply Rejection Ratio | PSRR | 25°C | 75 | 85 | - | dB | $V_{DD}=2.7V$ to 5.5V $V_{ICM}=1V$ |
| Output Source Current ^(Note 19) | I_{SOURCE} | 25°C | 20 | 45 | - | mA | $V_{OUT}=0V$ Short Circuit Current |
| Output Sink Current ^(Note 19) | I_{SINK} | 25°C | 20 | 40 | - | mA | $V_{OUT}=5V$ Short Circuit Current |
| Slew Rate | SR | 25°C | - | 2.0 | - | V/ μs | $C_L=25pF$ |
| Gain Bandwidth | GBW | 25°C | - | 5.5 | - | MHz | $C_L=25pF$, $A_V=40dB$ $f=1MHz$ |
| Phase Margin | θ | 25°C | - | 50 | - | deg | $C_L=25pF$, $A_V=40dB$ |
| Gain Margin | GM | 25°C | - | 4.5 | - | dB | $C_L=25pF$, $A_V=40dB$ |
| Input Referred Noise Voltage | V_N | 25°C | - | 30 | - | nV/ \sqrt{Hz} | $f=1kHz$ |
| Total Harmonic Distortion + Noise | THD+N | 25°C | - | 0.01 | - | % | $V_{OUT}=4.1V_{P-P}$, $f=1kHz$ $R_L=10k\Omega$ $A_V=0dB$, DIN-AUDIO |

(Note 17) Absolute value

(Note 18) Full Range: $T_A=-40^\circ C$ to $+85^\circ C$

(Note 19) Consider the power dissipation of the IC under high temperature environment when selecting the output current value.

There may be a case where the output current value is reduced due to the rise in IC temperature caused by the heat generated inside the IC.

(Note 20) Output load resistance connects to a half of V_{DD} .

Electrical Characteristics - continued

OLMR822xxx (Unless otherwise specified $V_{DD}=+2.5V$, $V_{SS}=0V$)

| Parameter | Symbol | Temperature Range | Limits | | | Unit | Conditions |
|--------------------------------|----------|-------------------|--------|------|-----|------|---------------------------|
| | | | Min | Typ | Max | | |
| Input Offset Voltage (Note 21) | V_{IO} | 25°C | - | 1 | 5 | mV | $V_{DD}=2.5V$ to 5.5V |
| | | Full Range | - | - | 5 | | |
| Maximum Output Voltage(High) | V_{OH} | 25°C | 2.30 | 2.37 | - | V | $R_L=600\Omega$ (Note 22) |
| | | | 2.40 | 2.46 | - | | $R_L=2k\Omega$ (Note 22) |
| Maximum Output Voltage(Low) | V_{OL} | 25°C | - | 130 | 200 | mV | $R_L=600\Omega$ (Note 22) |
| | | | - | 80 | 120 | | $R_L=2k\Omega$ (Note 22) |

(Note 21) Absolute value

(Note 22) Output load resistance connects to a half of V_{DD} .OLMR822xxx (Unless otherwise specified $V_{DD}=+2.7V$, $V_{SS}=0V$)

| Parameter | Symbol | Temperature Range | Limits | | | Unit | Conditions |
|-----------------------------------|--------------------------|-------------------|--------|------|------|------------------|---|
| | | | Min | Typ | Max | | |
| Input Offset Voltage (Note 23,24) | V_{IO} | 25°C | - | 1 | 5 | mV | $V_{DD}=2.5V$ to 5.5V |
| | | Full Range | - | - | 5 | | |
| Input Offset Voltage Drift | $\Delta V_{IO}/\Delta T$ | 25°C | - | 1 | - | $\mu V/^\circ C$ | - |
| Input Offset Current (Note 23) | I_{IO} | 25°C | - | 0.5 | 30 | nA | - |
| Input Bias Current (Note 23) | I_B | 25°C | - | 30 | 90 | nA | - |
| Supply Current (Note 24) | I_{DD} | 25°C | - | 560 | 680 | μA | $A_V=0dB$, $V_{+IN}=1.35V$ |
| | | Full Range | - | - | 1000 | | |
| Maximum Output Voltage(High) | V_{OH} | 25°C | 2.50 | 2.58 | - | V | $R_L=600\Omega$ (Note 26) |
| | | | 2.60 | 2.66 | - | | $R_L=2k\Omega$ (Note 26) |
| Maximum Output Voltage(Low) | V_{OL} | 25°C | - | 130 | 200 | mV | $R_L=600\Omega$ (Note 26) |
| | | | - | 80 | 120 | | $R_L=2k\Omega$ (Note 26) |
| Large Signal Voltage Gain | A_V | 25°C | - | 100 | - | dB | $R_L=600\Omega$ (Note 26) |
| | | | 95 | 100 | - | | $R_L=2k\Omega$ (Note 26) |
| Input Common-mode Voltage Range | V_{ICM} | 25°C | 0 | - | 1.8 | V | V_{SS} to ($V_{DD}-0.9V$) |
| Common-mode Rejection Ratio | CMRR | 25°C | 70 | 85 | - | dB | - |
| Power Supply Rejection Ratio | PSRR | 25°C | 75 | 85 | - | dB | $V_{DD}=2.7V$ to 5.5V $V_{ICM}=1V$ |
| Output Source Current (Note 25) | I_{SOURCE} | 25°C | 12 | 16 | - | mA | $V_{OUT}=0V$ Short Circuit Current |
| Output Sink Current (Note 25) | I_{SINK} | 25°C | 12 | 26 | - | mA | $V_{OUT}=2.7V$ Short Circuit Current |
| Slew Rate | SR | 25°C | - | 2.0 | - | V/ μs | $C_L=25pF$ |
| Gain Bandwidth | GBW | 25°C | - | 5.0 | - | MHz | $C_L=25pF$, $A_V=40dB$ $f=1MHz$ |
| Phase Margin | θ | 25°C | - | 50 | - | deg | $C_L=25pF$, $A_V=40dB$ |
| Gain Margin | GM | 25°C | - | 4.5 | - | dB | $C_L=25pF$, $A_V=40dB$ |
| Input Referred Noise Voltage | V_N | 25°C | - | 30 | - | nV/ \sqrt{Hz} | $f=1kHz$ |
| Total Harmonic Distortion + Noise | THD+N | 25°C | - | 0.01 | - | % | $V_{OUT}=2.2V_{P-P}$, $f=1kHz$ $R_L=10k\Omega$ $A_V=0dB$, DIN-AUDIO |
| Channel Separation | CS | 25°C | - | 100 | - | dB | $A_V=40dB$, $V_{OUT}=0.5V_{rms}$ |

(Note 23) Absolute value

(Note 24) Full Range: $T_A=-40^\circ C$ to $+85^\circ C$

(Note 25) Consider the power dissipation of the IC under high temperature environment when selecting the output current value.

There may be a case where the output current value is reduced due to the rise in IC temperature caused by the heat generated inside the IC.

(Note 26) Output load resistance connects to a half of V_{DD} .

Electrical Characteristics - continued

OLMR822xxx (Unless otherwise specified $V_{DD}=+5.0V$, $V_{SS}=0V$)

| Parameter | Symbol | Temperature Range | Limits | | | Unit | Conditions |
|--|--------------------------|-------------------|--------|------|------|------------------|---|
| | | | Min | Typ | Max | | |
| Input Offset Voltage ^(Note 27,28) | V_{IO} | 25°C | - | 1 | 5 | mV | $V_{DD}=2.5V$ to 5.5V |
| | | Full Range | - | - | 5 | | |
| Input Offset Voltage Drift | $\Delta V_{IO}/\Delta T$ | 25°C | - | 1 | - | $\mu V/^\circ C$ | - |
| Input Offset Current ^(Note 27) | I_{IO} | 25°C | - | 0.5 | 30 | nA | - |
| Input Bias Current ^(Note 27) | I_B | 25°C | - | 40 | 100 | nA | - |
| Supply Current ^(Note 28) | I_{DD} | 25°C | - | 650 | 850 | μA | $A_V=0dB$, $V_{+IN}=2.5V$ |
| | | Full Range | - | - | 1200 | | |
| Maximum Output Voltage(High) | V_{OH} | 25°C | 4.75 | 4.84 | - | V | $R_L=600\Omega$ ^(Note 30) |
| | | | 4.85 | 4.90 | - | | $R_L=2k\Omega$ ^(Note 30) |
| Maximum Output Voltage(Low) | V_{OL} | 25°C | - | 170 | 250 | mV | $R_L=600\Omega$ ^(Note 30) |
| | | | - | 100 | 150 | | $R_L=2k\Omega$ ^(Note 30) |
| Large Signal Voltage Gain | A_V | 25°C | - | 105 | - | dB | $R_L=600\Omega$ ^(Note 30) |
| | | | 95 | 105 | - | | $R_L=2k\Omega$ ^(Note 30) |
| Input Common-mode Voltage Range | V_{ICM} | 25°C | 0 | - | 4.1 | V | V_{SS} to $(V_{DD}-0.9V)$ |
| Common-mode Rejection Ratio | CMRR | 25°C | 72 | 90 | - | dB | - |
| Power Supply Rejection Ratio | PSRR | 25°C | 75 | 85 | - | dB | $V_{DD}=2.7V$ to 5.5V $V_{ICM}=1V$ |
| Output Source Current ^(Note 29) | I_{SOURCE} | 25°C | 20 | 45 | - | mA | $V_{OUT}=0V$ Short Circuit Current |
| Output Sink Current ^(Note 29) | I_{SINK} | 25°C | 20 | 40 | - | mA | $V_{OUT}=5V$ Short Circuit Current |
| Slew Rate | SR | 25°C | - | 2.0 | - | V/ μs | $C_L=25pF$ |
| Gain Bandwidth | GBW | 25°C | - | 5.5 | - | MHz | $C_L=25pF$, $A_V=40dB$ $f=1MHz$ |
| Phase Margin | θ | 25°C | - | 50 | - | deg | $C_L=25pF$, $A_V=40dB$ |
| Gain Margin | GM | 25°C | - | 4.5 | - | dB | $C_L=25pF$, $A_V=40dB$ |
| Input Referred Noise Voltage | V_N | 25°C | - | 30 | - | nV/\sqrt{Hz} | $f=1kHz$ |
| Total Harmonic Distortion + Noise | THD+N | 25°C | - | 0.01 | - | % | $V_{OUT}=4.1V_{P-P}$, $f=1kHz$ $R_L=10k\Omega$ $A_V=0dB$, DIN-AUDIO |
| Channel Separation | CS | 25°C | - | 100 | - | dB | $A_V=40dB$, $V_{OUT}=0.5V_{rms}$ |

(Note 27) Absolute value

(Note 28) Full Range: $T_A=-40^\circ C$ to $+85^\circ C$

(Note 29) Consider the power dissipation of the IC under high temperature environment when selecting the output current value.

There may be a case where the output current value is reduced due to the rise in IC temperature caused by the heat generated inside the IC.

(Note 30) Output load resistance connects to a half of V_{DD} .

Electrical Characteristics - continued

OLMR824xxx (Unless otherwise specified $V_{DD}=+2.5V$, $V_{SS}=0V$)

| Parameter | Symbol | Temperature Range | Limits | | | Unit | Condition |
|--------------------------------|----------|-------------------|--------|------|------|------|---------------------------|
| | | | Min. | Typ. | Max. | | |
| Input Offset Voltage (Note 31) | V_{IO} | 25°C | - | 1 | 5 | mV | $V_{DD}=2.5V$ to 5.5V |
| | | Full Range | - | - | 5 | | |
| Maximum Output Voltage(High) | V_{OH} | 25°C | 2.30 | 2.37 | - | V | $R_L=600\Omega$ (Note 32) |
| | | | 2.40 | 2.46 | - | | $R_L=2k\Omega$ (Note 32) |
| Maximum Output Voltage(Low) | V_{OL} | 25°C | - | 130 | 200 | mV | $R_L=600\Omega$ (Note 32) |
| | | | - | 80 | 120 | | $R_L=2k\Omega$ (Note 32) |

(Note 31) Absolute value

(Note 32) Output load resistance connects to a half of V_{DD} .OLMR824xxx (Unless otherwise specified $V_{DD}=+2.7V$, $V_{SS}=0V$)

| Parameter | Symbol | Temperature Range | Limits | | | Unit | Condition |
|-----------------------------------|--------------------------|-------------------|--------|------|------|------------------|---|
| | | | Min. | Typ. | Max. | | |
| Input Offset Voltage (Note 33,34) | V_{IO} | 25°C | - | 1 | 5 | mV | $V_{DD}=2.5V$ to 5.5V |
| | | Full Range | - | - | 5 | | |
| Input Offset Voltage Drift | $\Delta V_{IO}/\Delta T$ | 25°C | - | 1 | - | $\mu V/^\circ C$ | - |
| Input Offset Current (Note 33) | I_{IO} | 25°C | - | 0.5 | 30 | nA | - |
| Input Bias Current (Note 33) | I_B | 25°C | - | 30 | 90 | nA | - |
| Supply Current (Note 34) | I_{DD} | 25°C | - | 1120 | 1360 | μA | $A_V=0dB$, $V_{+IN}=1.35V$ |
| | | Full Range | - | - | 2000 | | |
| Maximum Output Voltage(High) | V_{OH} | 25°C | 2.50 | 2.58 | - | V | $R_L=600\Omega$ (Note 36) |
| | | | 2.60 | 2.66 | - | | $R_L=2k\Omega$ (Note 36) |
| Maximum Output Voltage(Low) | V_{OL} | 25°C | - | 130 | 200 | mV | $R_L=600\Omega$ (Note 36) |
| | | | - | 80 | 120 | | $R_L=2k\Omega$ (Note 36) |
| Large Signal Voltage Gain | A_V | 25°C | 90 | 100 | - | dB | $R_L=600\Omega$ (Note 36) |
| | | | 95 | 100 | - | | $R_L=2k\Omega$ (Note 36) |
| Input Common-mode Voltage Range | V_{ICM} | 25°C | 0 | - | 1.8 | V | V_{SS} to ($V_{DD}-0.9V$) |
| Common-mode Rejection Ratio | CMRR | 25°C | 70 | 85 | - | dB | - |
| Power Supply Rejection Ratio | PSRR | 25°C | 75 | 85 | - | dB | $V_{DD}=2.7V$ to 5.5V $V_{ICM}=1V$ |
| Output Source Current (Note 35) | I_{SOURCE} | 25°C | 12 | 16 | - | mA | $V_{OUT}=0V$ Short Circuit Current |
| Output Sink Current (Note 35) | I_{SINK} | 25°C | 12 | 26 | - | mA | $V_{OUT}=2.7V$ Short Circuit Current |
| Slew Rate | SR | 25°C | - | 2.0 | - | V/ μs | $C_L=25pF$ |
| Gain Bandwidth | GBW | 25°C | - | 5.0 | - | MHz | $C_L=25pF$, $A_V=40dB$ $f=1MHz$ |
| Phase Margin | θ | 25°C | - | 50 | - | deg | $C_L=25pF$, $A_V=40dB$ |
| Gain Margin | GM | 25°C | - | 4.5 | - | dB | $C_L=25pF$, $A_V=40dB$ |
| Input Referred Noise Voltage | V_N | 25°C | - | 30 | - | nV/ \sqrt{Hz} | $f=1kHz$ |
| Total Harmonic Distortion + Noise | THD+N | 25°C | - | 0.01 | - | % | $V_{OUT}=2.2V_{P-P}$, $f=1kHz$ $R_L=10k\Omega$ $A_V=0dB$, DIN-AUDIO |
| Channel Separation | CS | 25°C | - | 100 | - | dB | $A_V=40dB$, $V_{OUT}=0.5V_{rms}$ |

(Note 33) Absolute value

(Note 34) Full Range: $T_A=-40^\circ C$ to $+85^\circ C$

(Note 35) Consider the power dissipation of the IC under high temperature environment when selecting the output current value.

There may be a case where the output current value is reduced due to the rise in IC temperature caused by the heat generated inside the IC.

(Note 36) Output load resistance connects to a half of V_{DD} .

Electrical Characteristics - continued

OLMR824xxx (Unless otherwise specified $V_{DD}=+5V$, $V_{SS}=0V$)

| Parameter | Symbol | Temperature Range | Limits | | | Unit | Condition |
|--|--------------------------|-------------------|--------|------|------|------------------|---|
| | | | Min. | Typ. | Max. | | |
| Input Offset Voltage ^(Note 37,38) | V_{IO} | 25°C | - | 1 | 5 | mV | $V_{DD}=2.5V$ to 5.5V |
| | | Full Range | - | - | 5 | | |
| Input Offset Voltage Drift | $\Delta V_{IO}/\Delta T$ | 25°C | - | 1 | - | $\mu V/^\circ C$ | - |
| Input Offset Current ^(Note 37) | I_{IO} | 25°C | - | 0.5 | 30 | nA | - |
| Input Bias Current ^(Note 37) | I_B | 25°C | - | 40 | 100 | nA | - |
| Supply Current ^(Note 38) | I_{DD} | 25°C | - | 1130 | 1700 | μA | $A_V=0dB$, $V_{+IN}=2.5V$ |
| | | Full Range | - | - | 2400 | | |
| Maximum Output Voltage(High) | V_{OH} | 25°C | 4.75 | 4.84 | - | V | $R_L=600\Omega$ ^(Note 40) |
| | | | 4.85 | 4.90 | - | | $R_L=2k\Omega$ ^(Note 40) |
| Maximum Output Voltage(Low) | V_{OL} | 25°C | - | 170 | 250 | mV | $R_L=600\Omega$ ^(Note 40) |
| | | | - | 100 | 150 | | $R_L=2k\Omega$ ^(Note 40) |
| Large Signal Voltage Gain | A_V | 25°C | - | 105 | - | dB | $R_L=600\Omega$ ^(Note 40) |
| | | | 95 | 105 | - | | $R_L=2k\Omega$ ^(Note 40) |
| Input Common-mode Voltage Range | V_{ICM} | 25°C | 0 | - | 4.1 | V | V_{SS} to ($V_{DD}-0.9V$) |
| Common-mode Rejection Ratio | CMRR | 25°C | 72 | 90 | - | dB | - |
| Power Supply Rejection Ratio | PSRR | 25°C | 75 | 85 | - | dB | $V_{DD}=2.7V$ to 5.5V $V_{ICM}=1V$ |
| Output Source Current ^(Note 39) | I_{SOURCE} | 25°C | 20 | 45 | - | mA | $V_{OUT}=0V$ Short Circuit Current |
| Output Sink Current ^(Note 39) | I_{SINK} | 25°C | 20 | 40 | - | mA | $V_{OUT}=5V$ Short Circuit Current |
| Slew Rate | SR | 25°C | 1.4 | 2.0 | - | V/ μs | $C_L=25pF$ |
| Gain Bandwidth | GBW | 25°C | - | 5.5 | - | MHz | $C_L=25pF$, $A_V=40dB$ $f=1MHz$ |
| Phase Margin | θ | 25°C | - | 50 | - | deg | $C_L=25pF$, $A_V=40dB$ |
| Gain Margin | GM | 25°C | - | 4.5 | - | dB | $C_L=25pF$, $A_V=40dB$ |
| Input Referred Noise Voltage | V_N | 25°C | - | 30 | - | nV/ \sqrt{Hz} | $f=1kHz$ |
| Total Harmonic Distortion + Noise | THD+N | 25°C | - | 0.01 | - | % | $V_{OUT}=4.1V_{P-P}$, $f=1kHz$ $R_L=10k\Omega$ $A_V=0dB$, DIN-AUDIO |
| Channel Separation | CS | 25°C | - | 100 | - | dB | $A_V=40dB$, $V_{OUT}=0.5V_{rms}$ |

(Note 37) Absolute value

(Note 38) Full Range: $T_A=-40^\circ C$ to $+85^\circ C$

(Note 39) Consider the power dissipation of the IC under high temperature environment when selecting the output current value.

There may be a case where the output current value is reduced due to the rise in IC temperature caused by the heat generated inside the IC.

(Note 40) Output load resistance connects to a half of V_{DD} .

Description of Electrical Characteristics

Described below are the relevant electrical terms used in this datasheet. Items and symbols used are also shown. Note that the item names, symbols, and their meanings may differ from those of another manufacturer's document or a general document.

1. Absolute Maximum Ratings

Absolute maximum rating items indicate the conditions which must not be exceeded. Application of voltage in excess of absolute maximum rating or use out of absolute maximum rated temperature environment may cause deterioration of characteristics.

- (1) Supply Voltage (V_{DD}/V_{SS})
Indicates the maximum voltage that can be applied between the VDD terminal and VSS terminal without deterioration of characteristics of internal circuit.
- (2) Differential Input Voltage (V_{ID})
Indicates the maximum voltage that can be applied between the non-inverting terminal and inverting terminal without damaging the IC.
- (3) Input Common-mode Voltage Range (V_{ICM})
Indicates the maximum voltage that can be applied to the non-inverting and inverting terminals without deterioration of electrical characteristics. The input common-mode voltage range of the maximum ratings does not assure normal operation of IC. For normal operation, use the IC within the input common-mode voltage range.
- (4) Power Dissipation (Pd)
Indicates the power that can be consumed by the IC when mounted on a specific board at ambient temperature (normal temperature), 25°C. As for the packaged product, Pd is determined by the temperature that can be permitted by the IC in the package (maximum junction temperature) and thermal resistance of the package.

2. Electrical Characteristics

- (1) Input Offset Voltage (V_{IO})
Indicates the voltage difference between the non-inverting terminal and inverting terminal. It can be translated to the input voltage difference required for setting the output voltage to 0 V.
- (2) Input Offset Voltage Drift ($\Delta V_{IO}/\Delta T$)
Denotes the ratio of the input offset voltage fluctuation to the ambient temperature fluctuation.
- (3) Input Offset Current (I_{IO})
Indicates the difference of input bias current between non-inverting and inverting terminals.
- (4) Input Bias Current (I_B)
Indicates the current that flows into or out of the input terminal. It is defined by the average of input bias currents at the non-inverting and inverting terminals.
- (5) Supply Current (I_{DD})
Indicates the current that is consumed by the IC under specified no-load conditions.
- (6) Maximum Output Voltage (High) / Maximum Output Voltage (Low) (V_{OH}/V_{OL})
Indicates the output voltage range under a specified load condition. It can be differentiated to maximum output voltage high and low. Maximum output voltage high indicates the upper limit of the output voltage, and maximum output voltage low indicates the lower limit.
- (7) Large Signal Voltage Gain (A_V)
Indicates the amplification rate (gain) of output voltage against the voltage difference between the non-inverting and inverting terminal. It is normally the amplification rate (gain) in reference to DC voltage.
 $A_V = (\text{Output voltage}) / (\text{Differential Input voltage})$
- (8) Input Common-mode Voltage Range (V_{ICM})
Indicates the input voltage range at which the IC operates normally.
- (9) Common-mode Rejection Ratio (CMRR)
Indicates the ratio of fluctuation of input offset voltage to the change of common-mode input voltage.
 $CMRR = (\text{Change of Input common-mode voltage}) / (\text{Input offset fluctuation})$
- (10) Power Supply Rejection Ratio (PSRR)
Indicates the ratio of fluctuation of input offset voltage to the change in supply voltage.
 $PSRR = (\text{Change of power supply voltage}) / (\text{Input offset fluctuation})$
- (11) Output Source Current/ Output Sink Current (I_{SOURCE} / I_{SINK})
The maximum current that the IC can output under specific conditions. The output source current indicates the current flowing out from the IC, and the output sink current indicates the current flowing into the IC.
- (12) Slew Rate (SR)
Indicates the rate of the change in output voltage with time when a step input signal is applied.
- (13) Gain Band Width (GBW)
The product of the open-loop voltage gain and the frequency at which the voltage gain decreases by 6dB/octave.
- (14) Phase Margin (θ)
Indicates the margin of phase from 180° phase lag at unity gain frequency.
- (15) Gain Margin (GM)
Indicates the difference between 0dB and gain where the operational amplifier has 180° phase delay.

- (16) Total Harmonic Distortion + Noise (THD+N)
Indicates the fluctuation of input offset voltage or that of output voltage with reference to the change of output voltage of driven channel.
- (17) Input Referred Noise Voltage (V_N)
Indicates the noise voltage generated inside the operational amplifier equivalent to an ideal voltage source connected in series with input terminal.
- (18) Channel Separation (CS)
Indicates the fluctuation of the output voltage of the driven channel with reference to the change of output voltage of the channel which is not driven.

Typical Performance Curves
OLMR821G

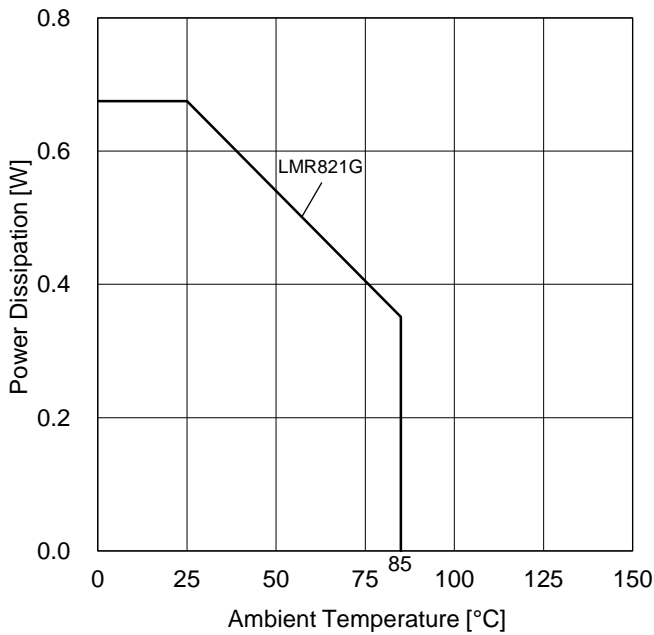

Figure 1. Power Dissipation vs Ambient Temperature (Derating Curve)

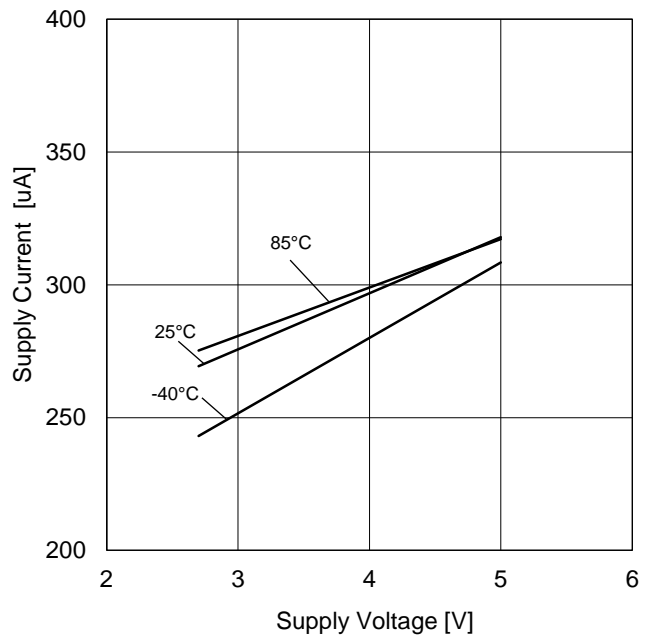

Figure 2. Supply Current vs Supply Voltage

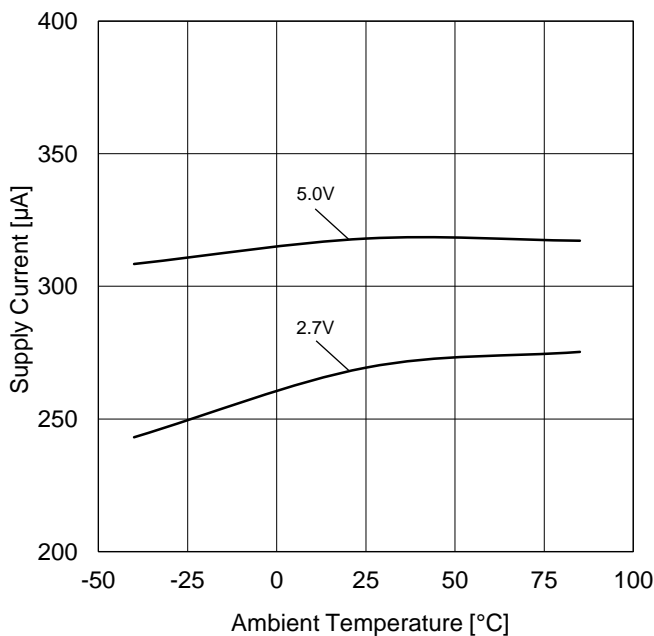

Figure 3. Supply Current vs Ambient Temperature

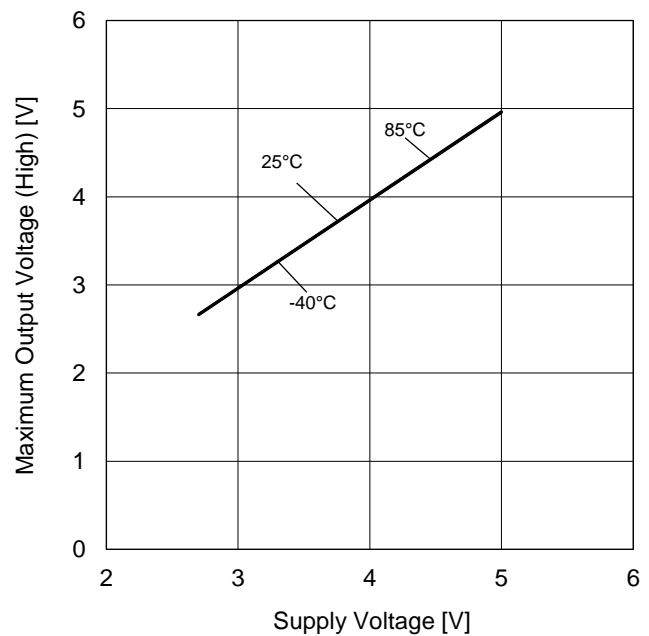

Figure 4. Maximum Output Voltage (High) vs Supply Voltage (RL=2kΩ)

(*)The data above are measurement values of a typical sample, it is not guaranteed.

Typical Performance Curves – continued
OLMR821G

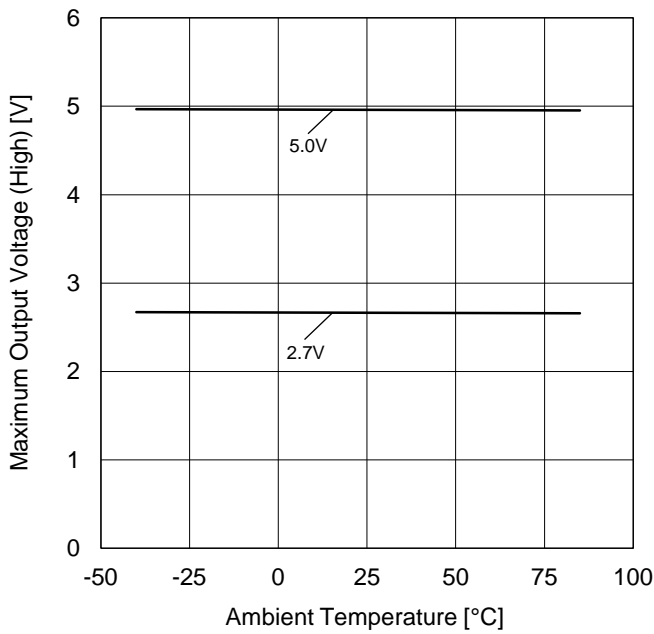

Figure 5. Maximum Output Voltage (High) vs Ambient Temperature ($R_L=2k\Omega$)

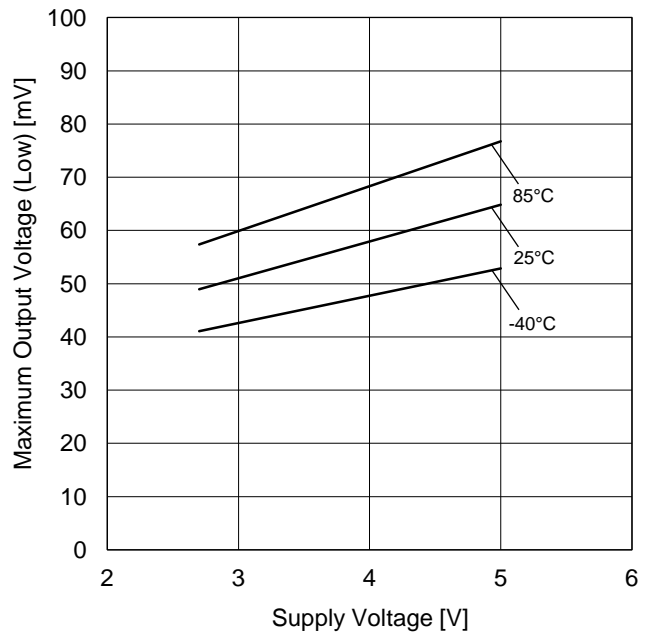

Figure 6. Maximum Output Voltage (Low) vs Supply Voltage ($R_L=2k\Omega$)

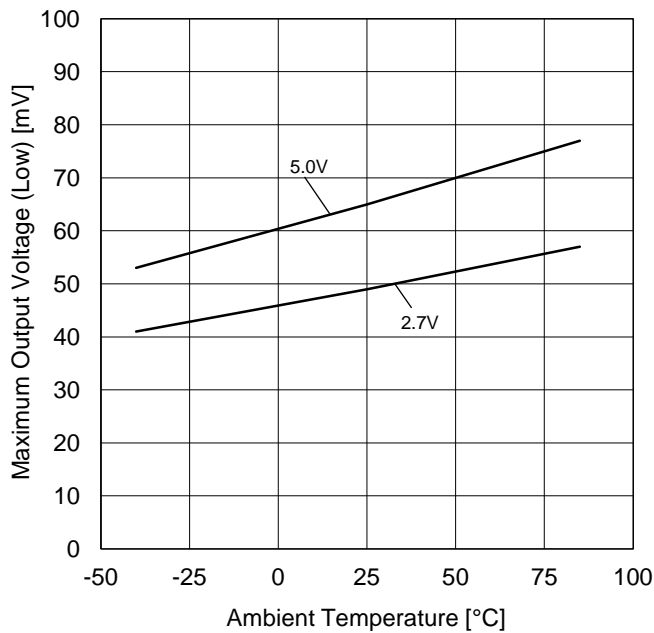

Figure 7. Maximum Output Voltage (Low) vs Ambient Temperature ($R_L=2k\Omega$)

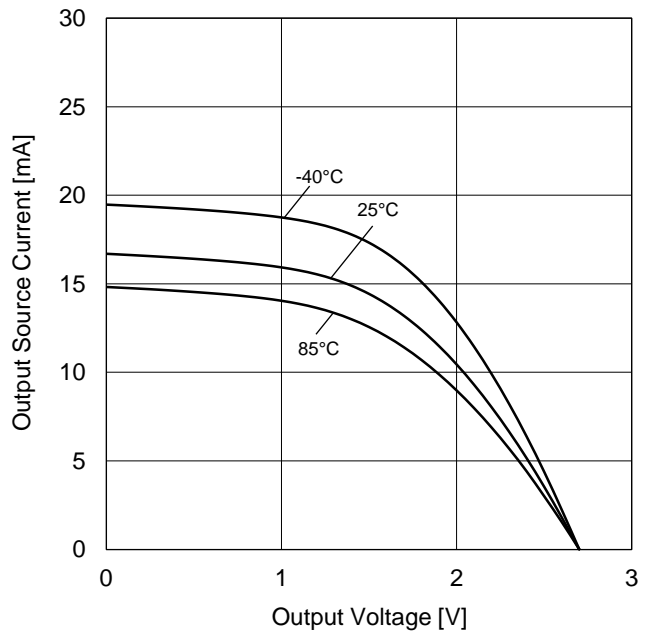

Figure 8. Output Source Current vs Output Voltage ($V_{DD}=2.7V$)

(*)The data above are measurement values of a typical sample, it is not guaranteed.

Typical Performance Curves – continued
OLMR821G

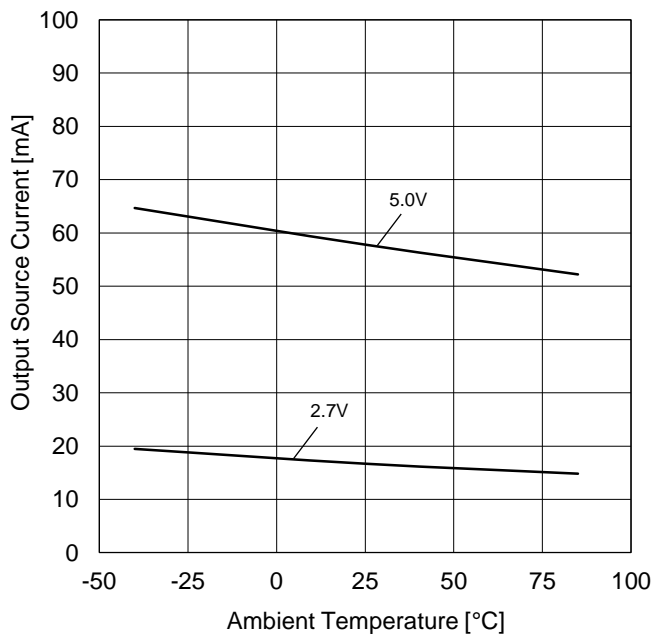

Figure 9. Output Source Current vs Ambient Temperature

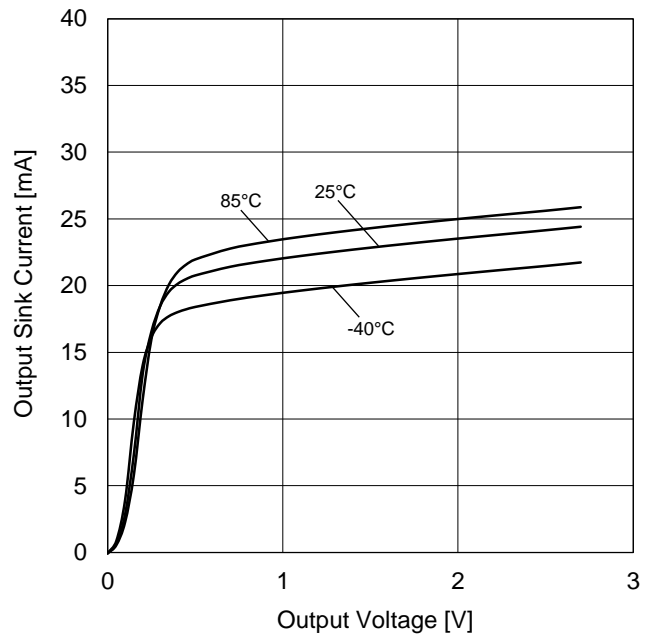

Figure 10. Output Sink Current vs Output Voltage ($V_{DD}=2.7V$)

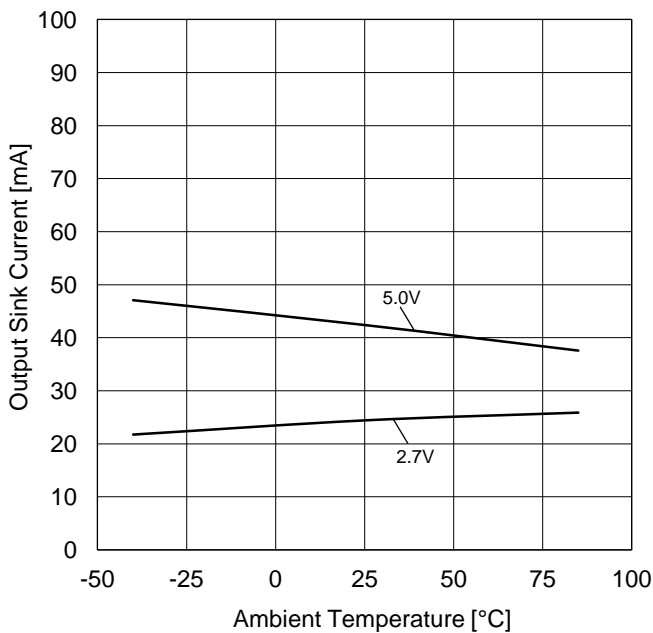

Figure 11. Output Sink Current vs Ambient Temperature

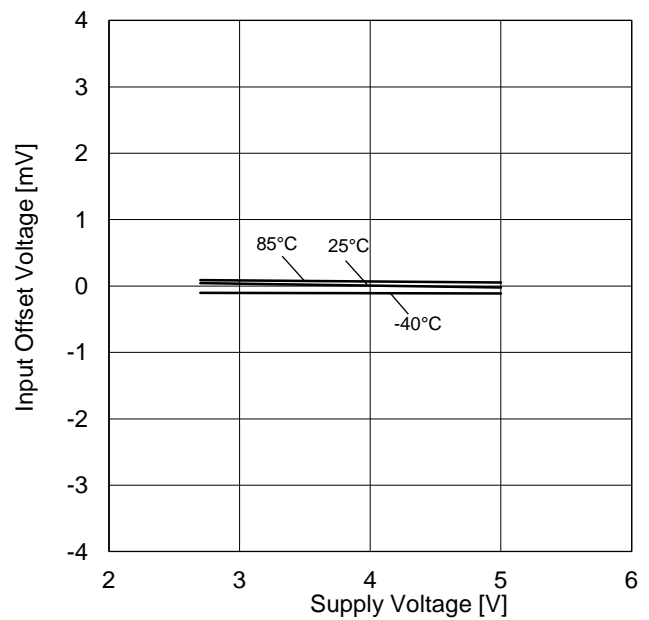

Figure 12. Input Offset Voltage vs Supply Voltage ($V_{ICM}=V_{DD}/2$, $E_K=-V_{DD}/2$)

(*)The data above are measurement values of a typical sample, it is not guaranteed.

Typical Performance Curves – continued
OLMR821G

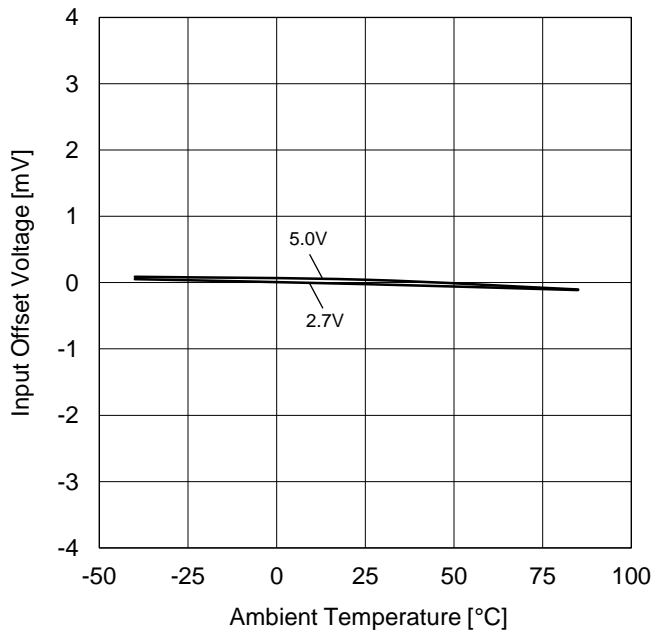

Figure 13. Input Offset Voltage vs Ambient Temperature ($V_{ICM}=V_{DD}/2$, $E_K=-V_{DD}/2$)

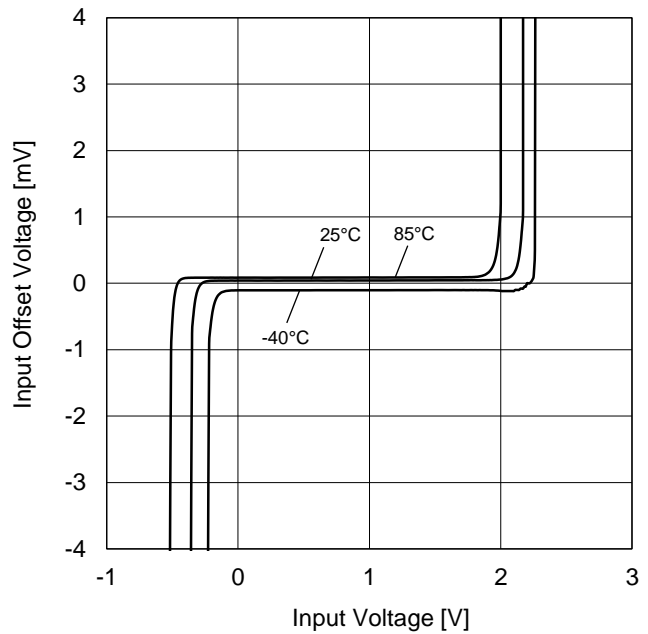

Figure 14. Input Offset Voltage vs Input Voltage ($V_{DD}=2.7V$)

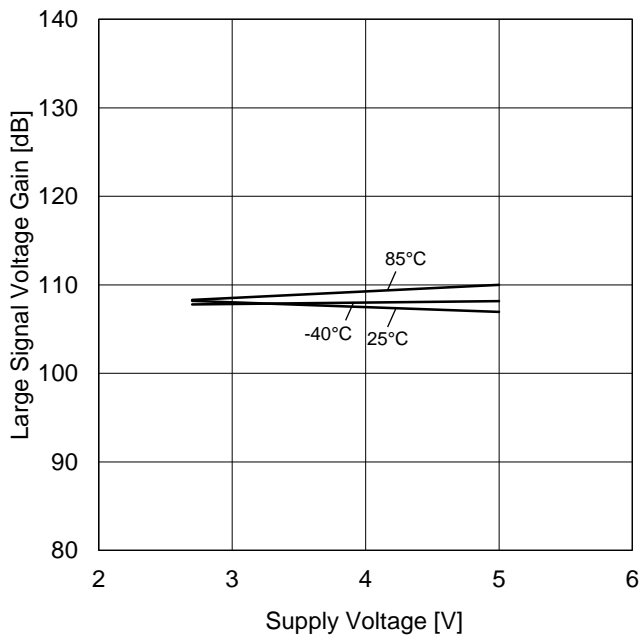

Figure 15. Large Signal Voltage Gain vs Supply Voltage

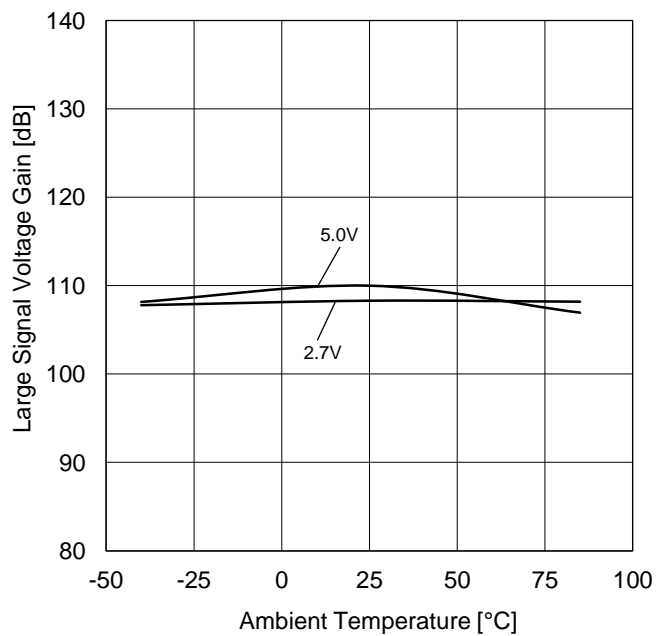

Figure 16. Large Signal Voltage Gain vs Ambient Temperature

(*)The data above are measurement values of a typical sample, it is not guaranteed.

Typical Performance Curves – continued
OLMR821G

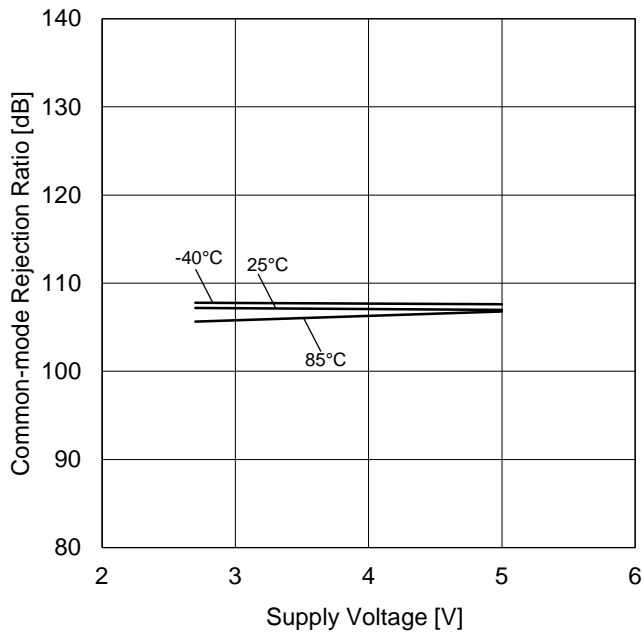

Figure 17. Common-mode Rejection Ratio vs Supply Voltage ($V_{DD}=2.7V$)

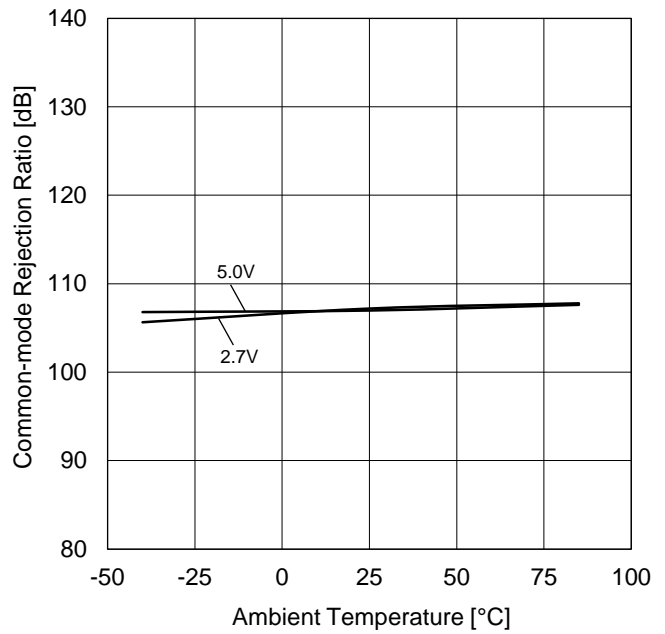

Figure 18. Common-mode Rejection Ratio vs Ambient Temperature

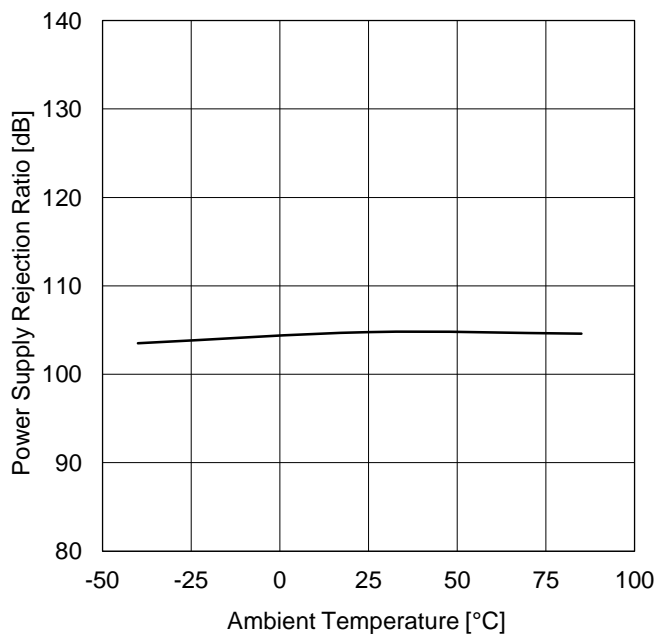

Figure 19. Power Supply Rejection Ratio vs Ambient Temperature ($V_{DD}=2.7V$ to $5.0V$)

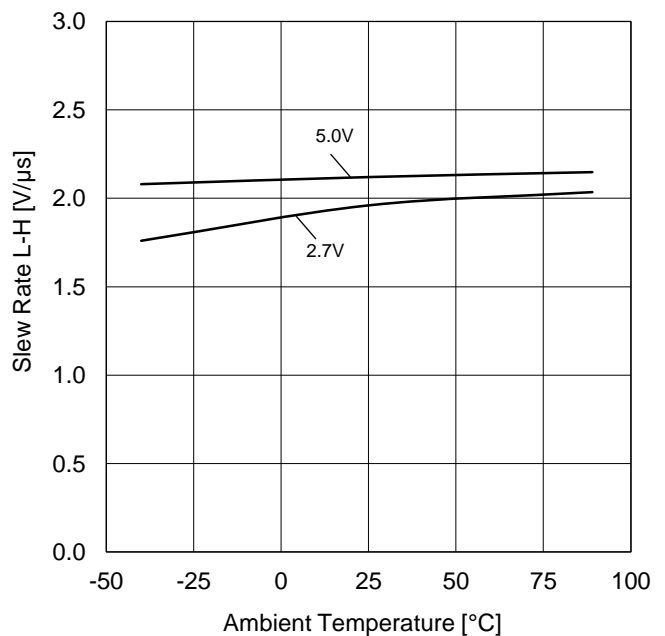

Figure 20. Slew Rate L-H vs Ambient Temperature

(*)The data above are measurement values of a typical sample, it is not guaranteed.

Typical Performance Curves – continued
OLMR821G

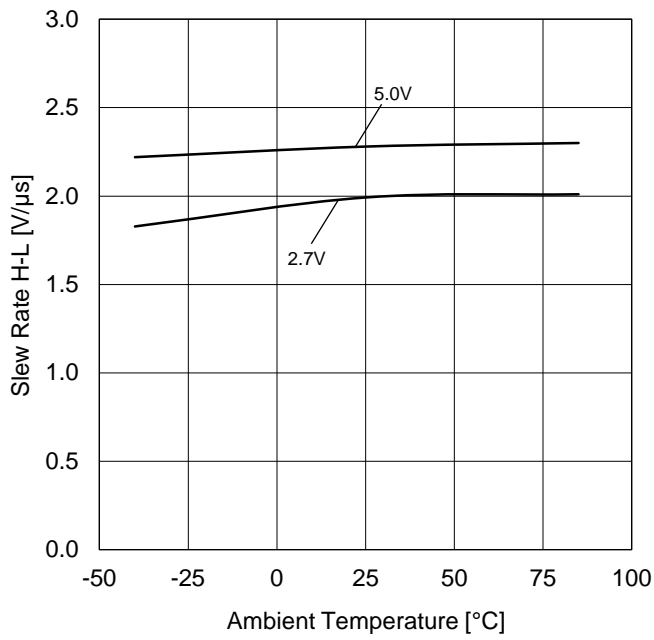

Figure 21. Slew Rate H-L vs Ambient Temperature

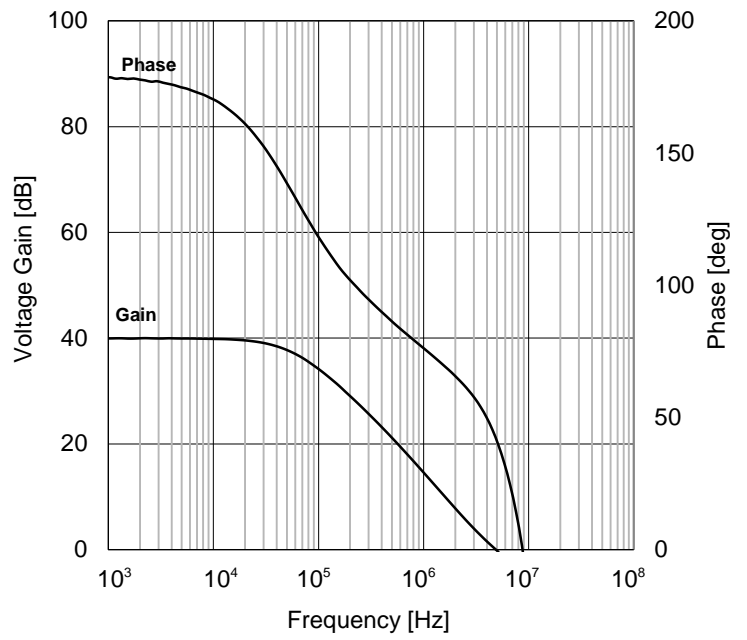

Figure 22. Voltage Gain · Phase vs Frequency

(*)The data above are measurement values of a typical sample, it is not guaranteed.

Typical Performance Curves – continued
OLMR822xxx

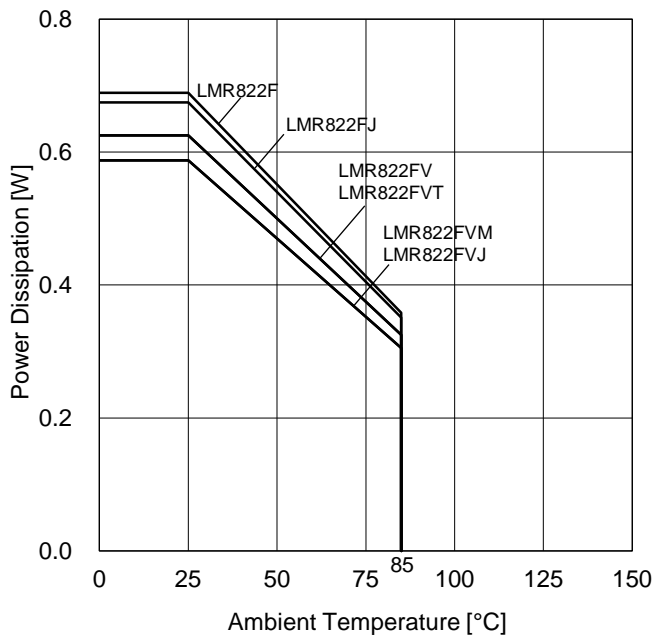

Figure 23. Power Dissipation vs Ambient Temperature (Derating Curve)

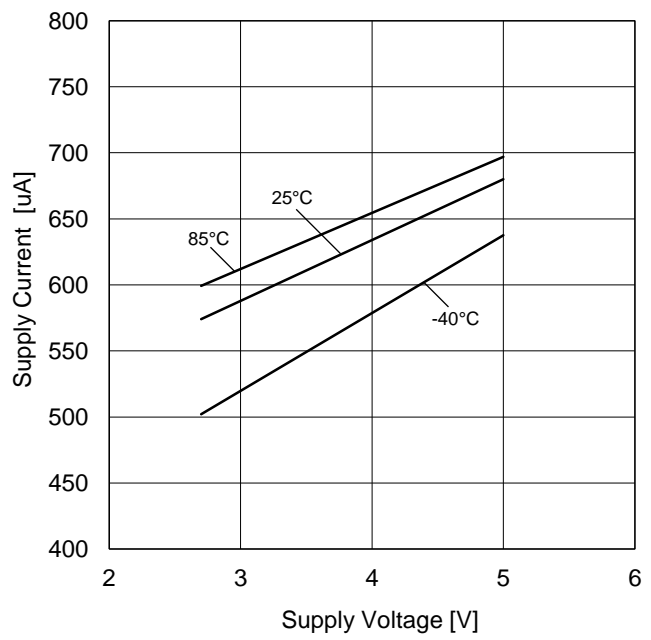

Figure 24. Supply Current vs Supply Voltage

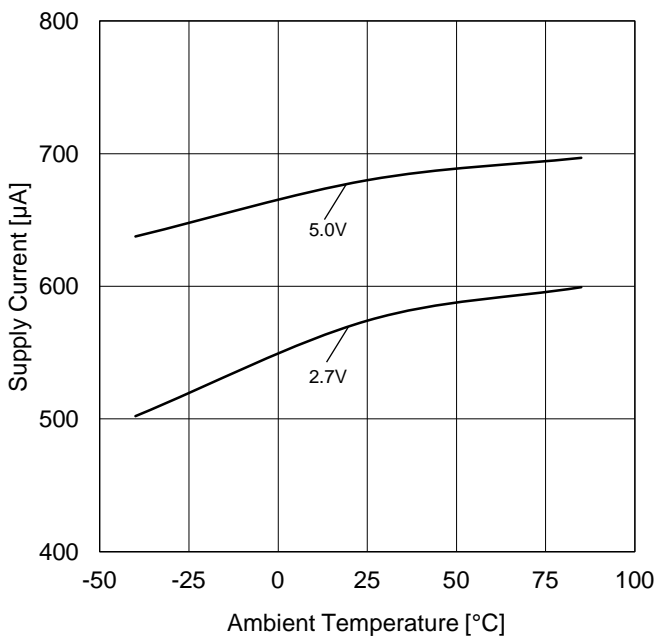

Figure 25. Supply Current vs Ambient Temperature

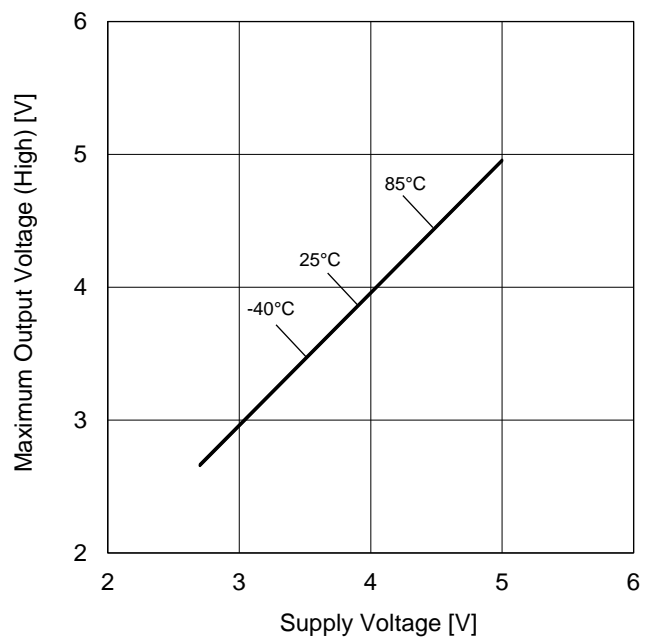

Figure 26. Maximum Output Voltage (High) vs Supply Voltage ($R_L=2k\Omega$)

(*)The data above are measurement values of a typical sample, it is not guaranteed.

Typical Performance Curves – continued
OLMR822xxx

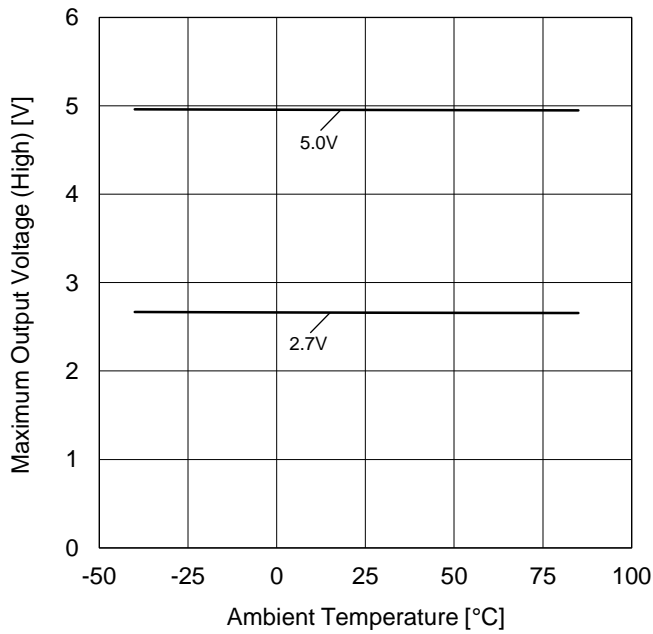

Figure 27. Maximum Output Voltage (High) vs Ambient Temperature ($R_L=2k\Omega$)

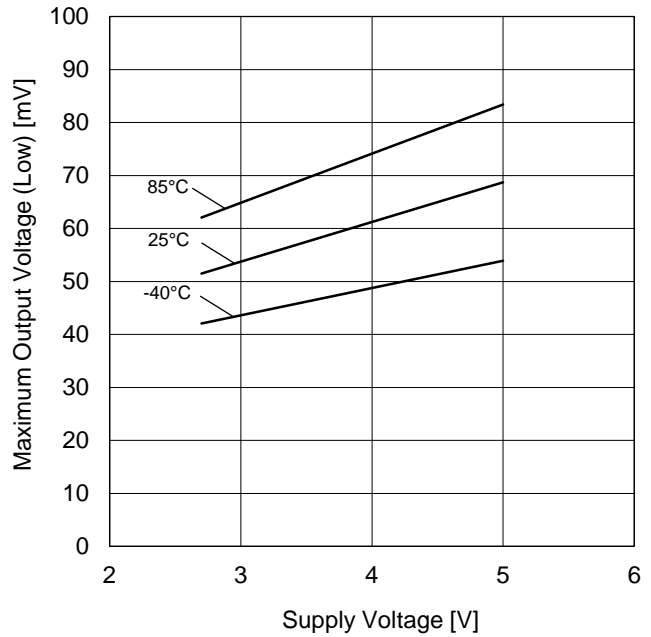

Figure 28. Maximum Output Voltage (Low) vs Supply Voltage ($R_L=2k\Omega$)

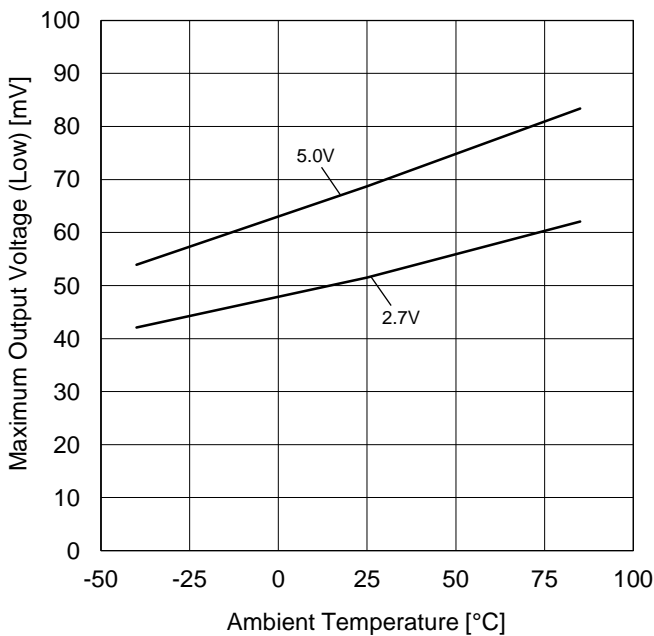

Figure 29. Maximum Output Voltage (Low) vs Ambient Temperature ($R_L=2k\Omega$)

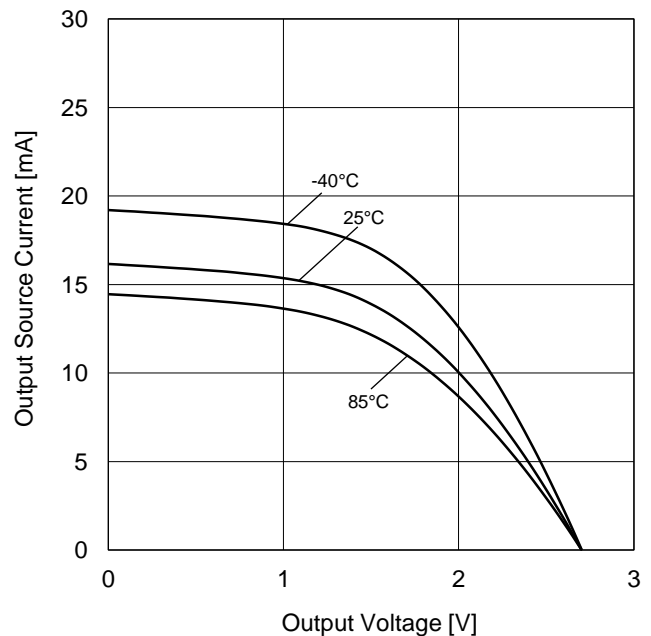

Figure 30. Output Source Current vs Output Voltage ($V_{DD}=2.7V$)

(*)The data above are measurement values of a typical sample, it is not guaranteed.

Typical Performance Curves – continued
OLMR822xxx

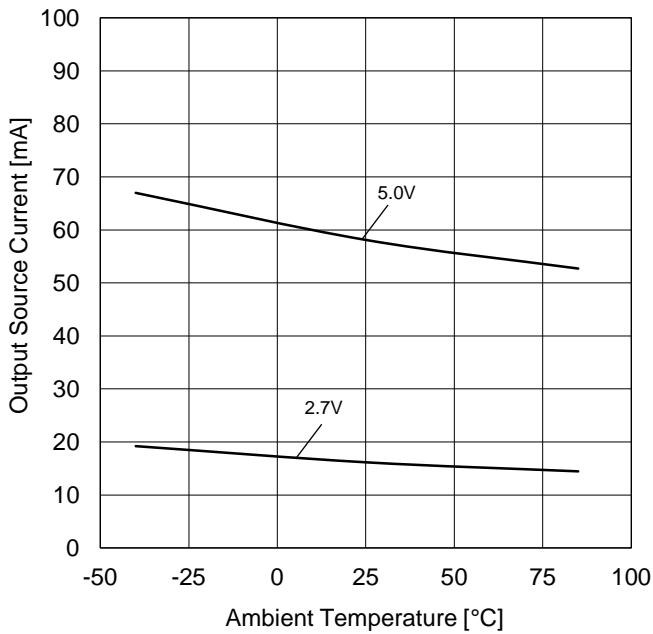

Figure 31. Output Source Current vs Ambient Temperature

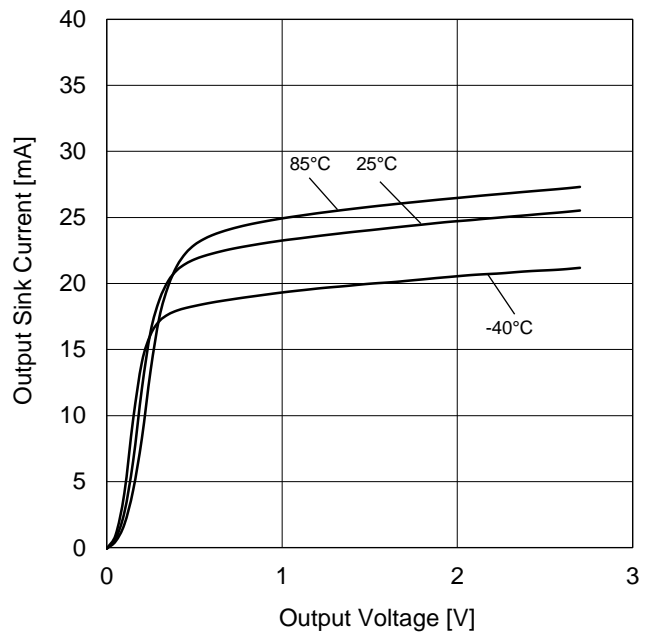

Figure 32. Output Sink Current vs Output Voltage ($V_{DD}=2.7V$)

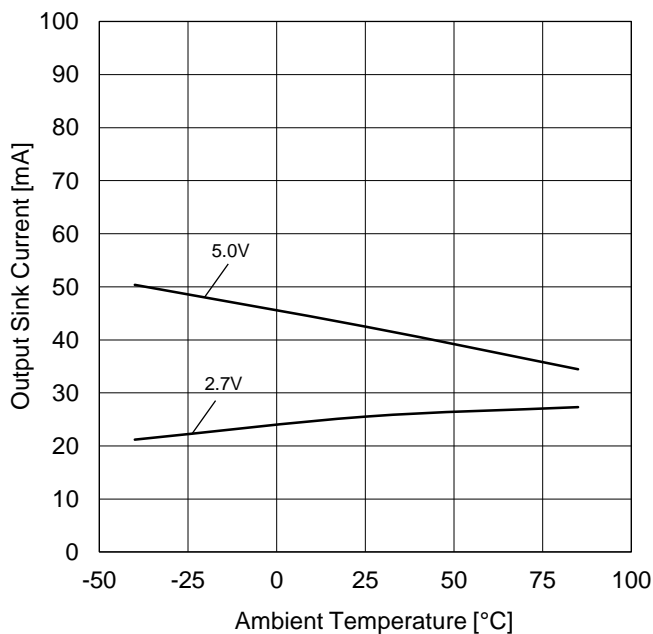

Figure 33. Output Sink Current vs Ambient Temperature

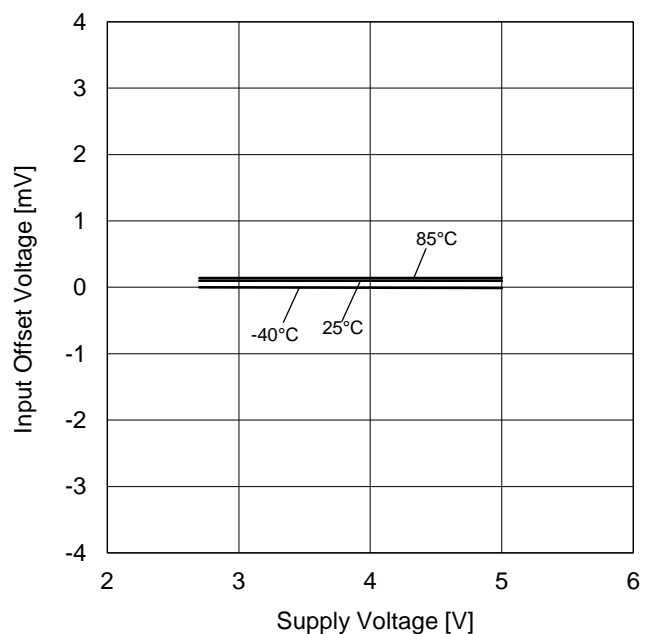

Figure 34. Input Offset Voltage vs Supply Voltage ($V_{ICM}=V_{DD}/2$, $E_K=-V_{DD}/2$)

(*)The data above are measurement values of a typical sample, it is not guaranteed.

Typical Performance Curves – continued
OLMR822xxx

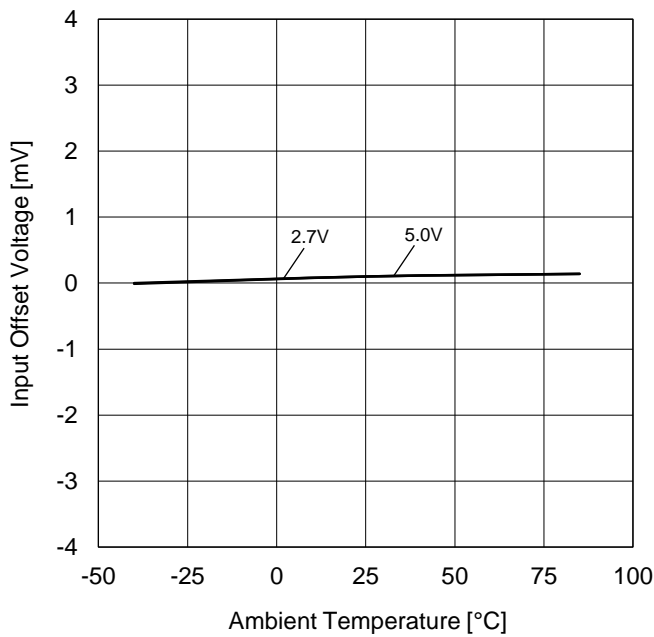

Figure 35. Input Offset Voltage vs Ambient Temperature ($V_{ICM}=V_{DD}/2$, $E_K=-V_{DD}/2$)

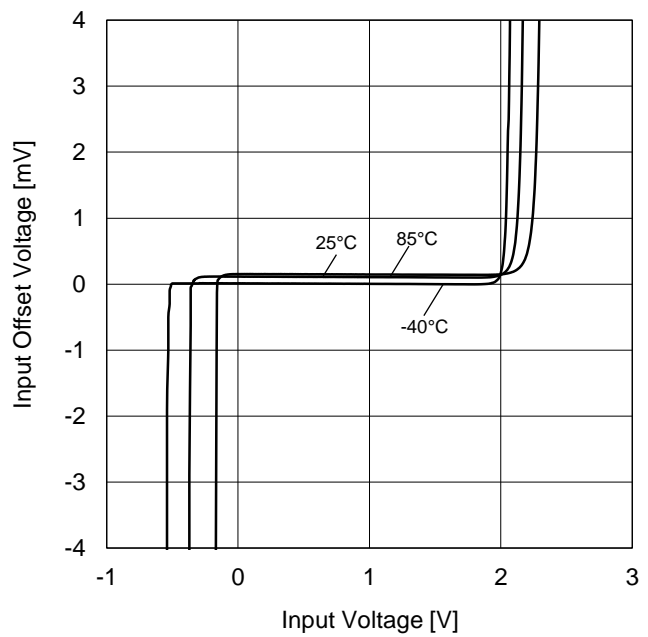

Figure 36. Input Offset Voltage vs Input Voltage ($V_{DD}=2.7V$)

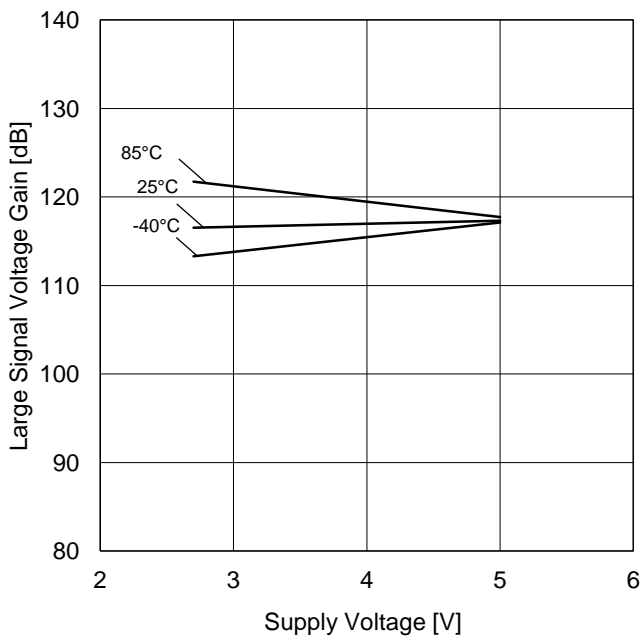

Figure 37. Large Signal Voltage Gain vs Supply Voltage

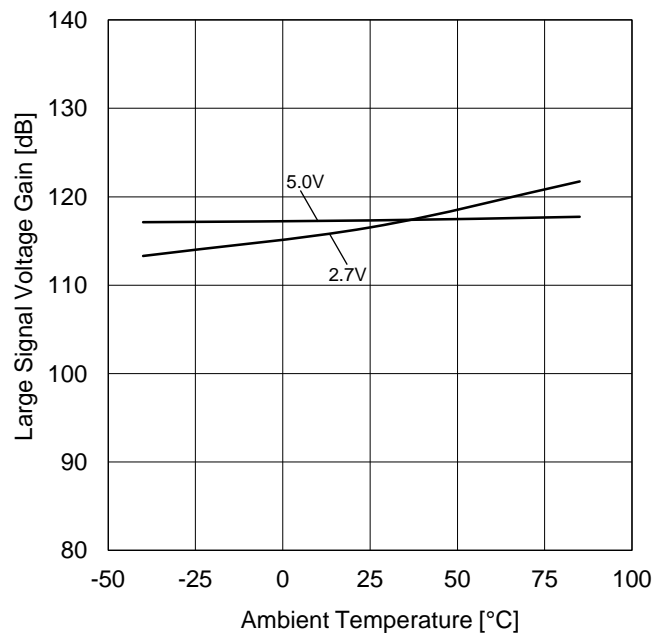

Figure 38. Large Signal Voltage Gain vs Ambient Temperature

(*)The data above are measurement values of a typical sample, it is not guaranteed.

Typical Performance Curves – continued
OLMR822xxx

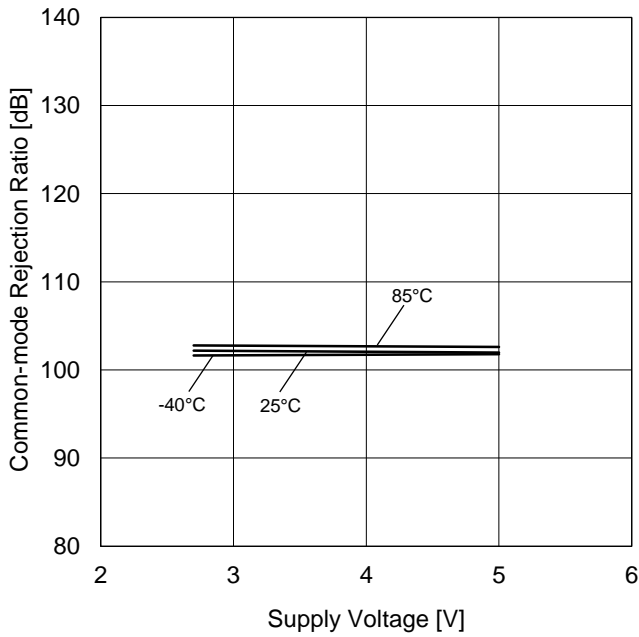

Figure 39. Common-mode Rejection Ratio vs Supply Voltage ($V_{DD}=2.7V$)

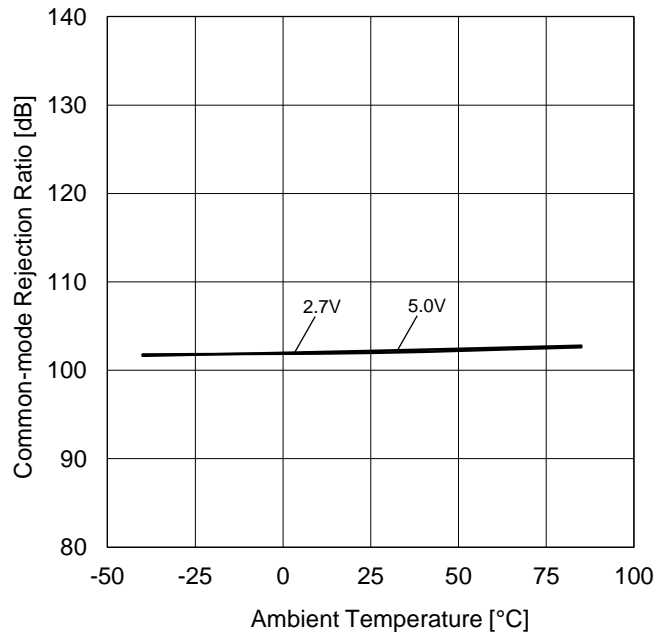

Figure 40. Common-mode Rejection Ratio vs Ambient Temperature

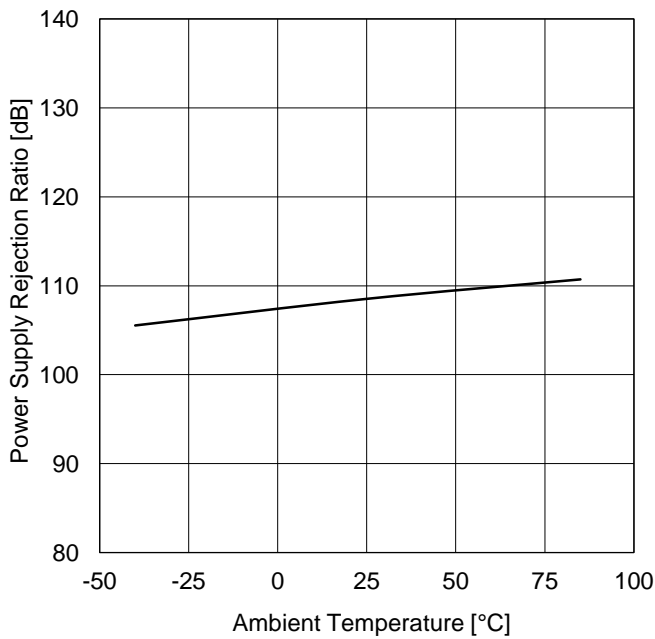

Figure 41. Power Supply Rejection Ratio vs Ambient Temperature ($V_{DD}=2.7V$ to $5.0V$)

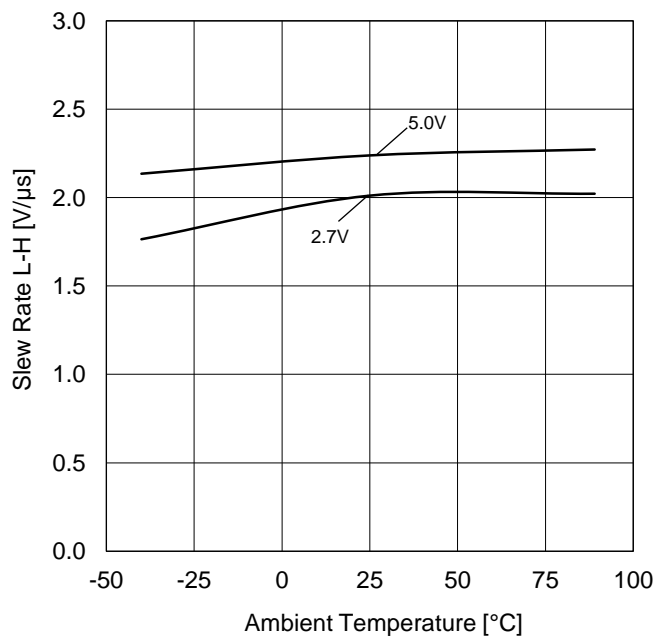

Figure 42. Slew Rate L-H vs Ambient Temperature

(*)The data above are measurement values of a typical sample, it is not guaranteed.

Typical Performance Curves – continued
OLMR822xxx

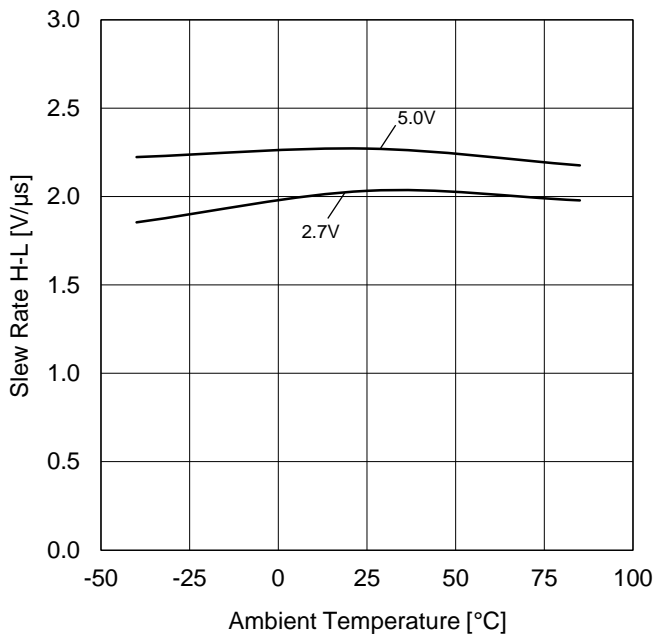

Figure 43. Slew Rate H-L vs Ambient Temperature

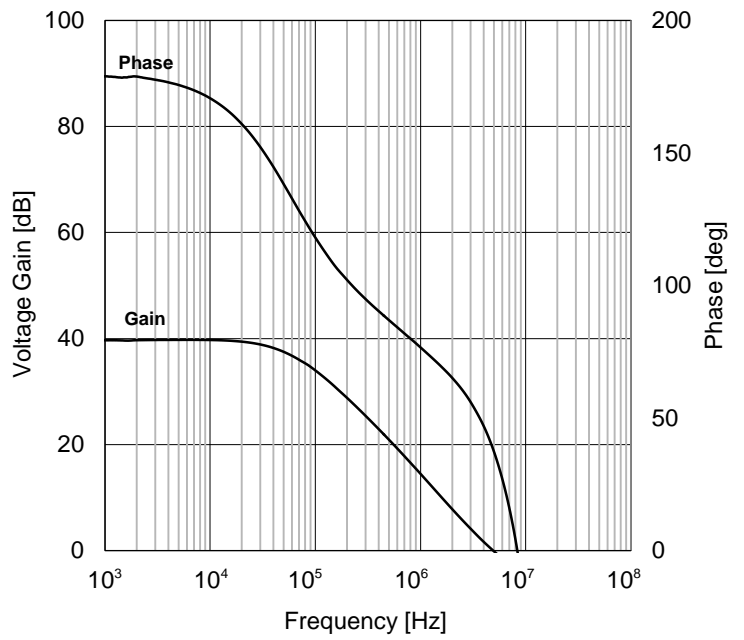

Figure 44. Voltage Gain · Phase vs Frequency

(*)The data above are measurement values of a typical sample, it is not guaranteed.

Typical Performance Curves – continued
OLMR824xxx

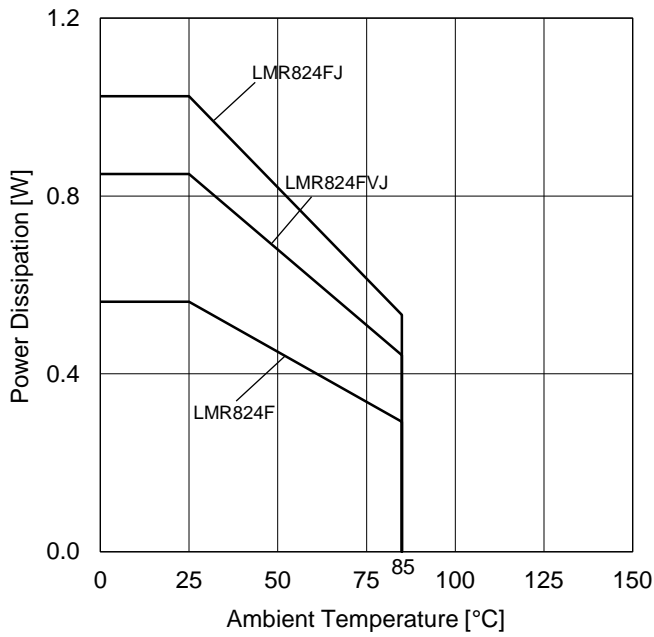

Figure 45. Power Dissipation vs Ambient Temperature (Derating Curve)

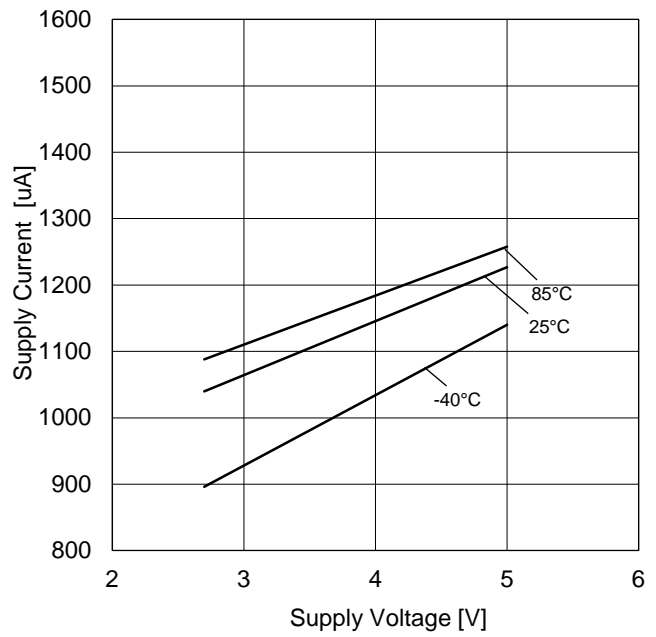

Figure 46. Supply Current vs Supply Voltage

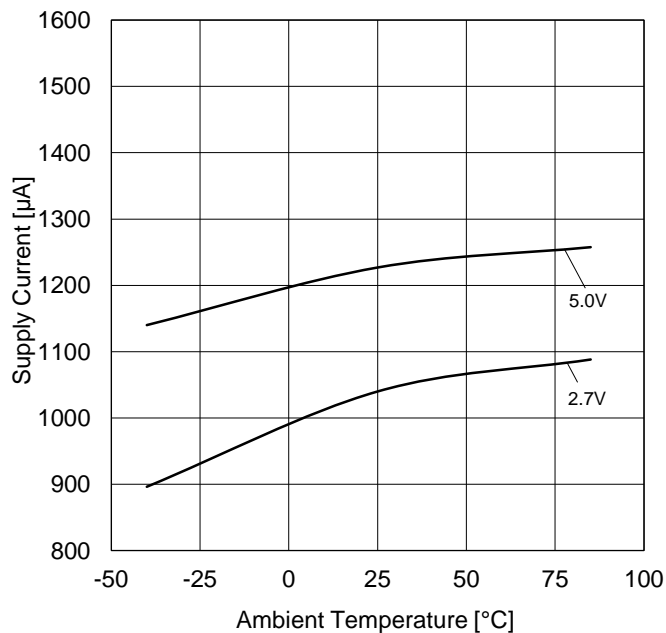

Figure 47. Supply Current vs Ambient Temperature

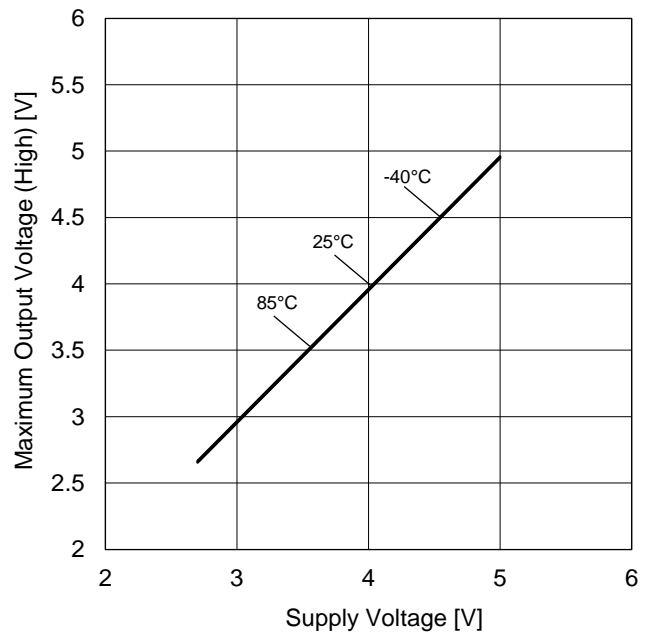

Figure 48. Maximum Output Voltage (High) vs Supply Voltage ($R_L=2k\Omega$)

(*)The data above are measurement values of a typical sample, it is not guaranteed.

Typical Performance Curves – continued
OLMR824xxx

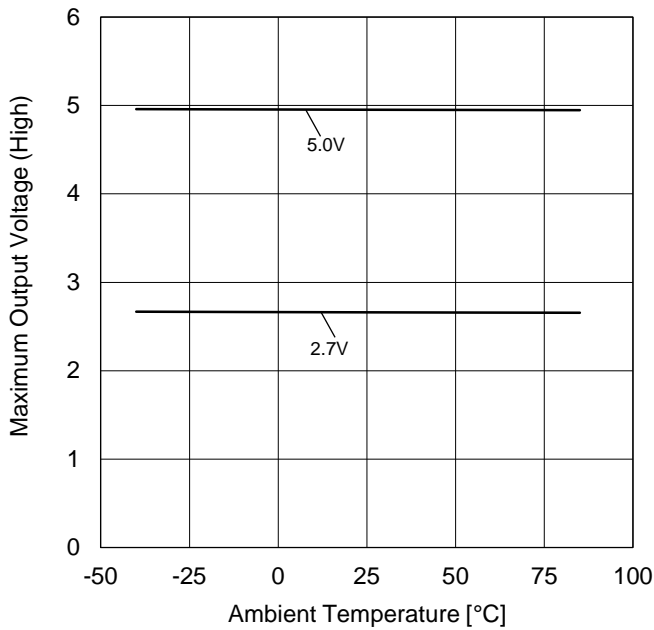

Figure 49. Maximum Output Voltage (High) vs Ambient Temperature ($R_L=2k\Omega$)

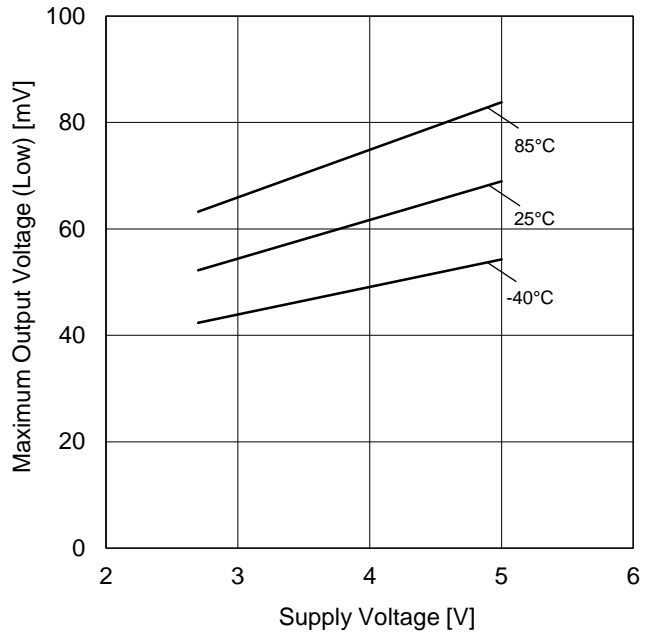

Figure 50. Maximum Output Voltage (Low) vs Supply Voltage ($R_L=2k\Omega$)

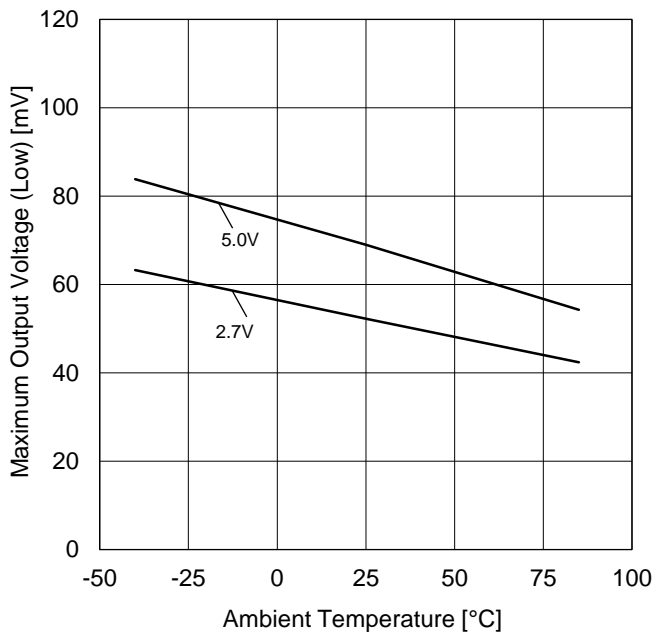

Figure 51. Maximum Output Voltage (Low) vs Ambient Temperature ($R_L=2k\Omega$)

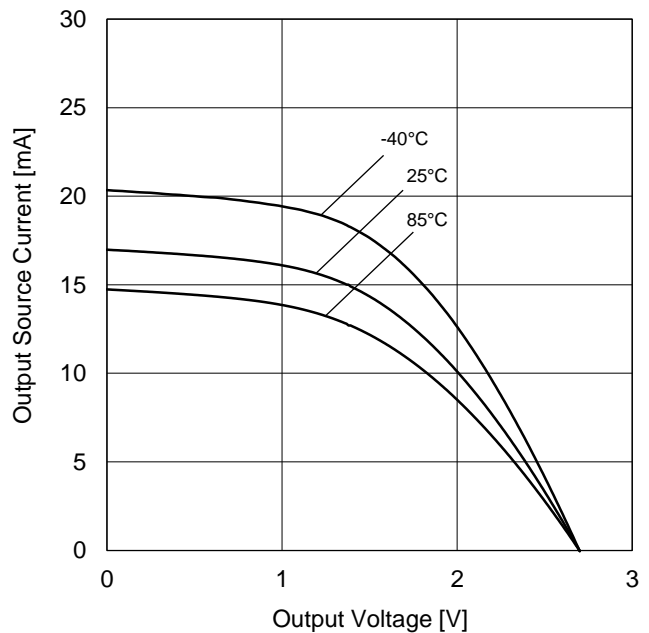

Figure 52. Output Source Current vs Output Voltage ($V_{DD}=2.7V$)

(*)The data above are measurement values of a typical sample, it is not guaranteed.

Typical Performance Curves – continued
OLMR824xxx

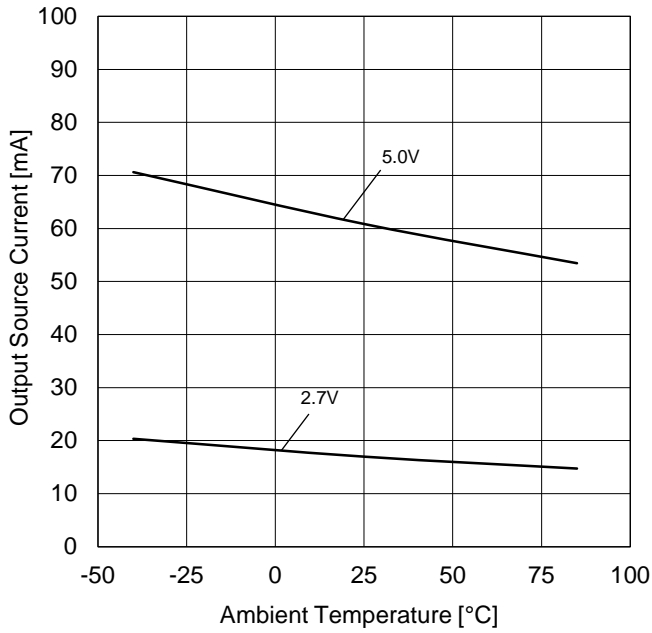

Figure 53. Output Source Current vs Ambient Temperature

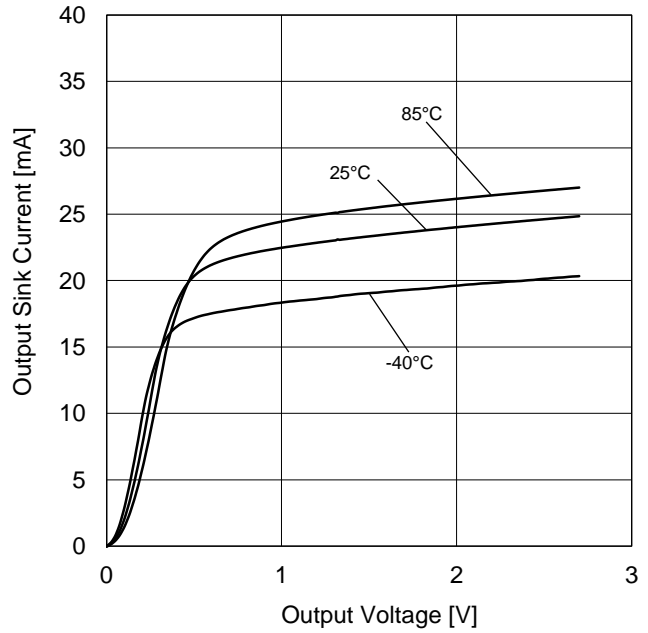

Figure 54. Output Sink Current vs Output Voltage ($V_{DD}=2.7V$)

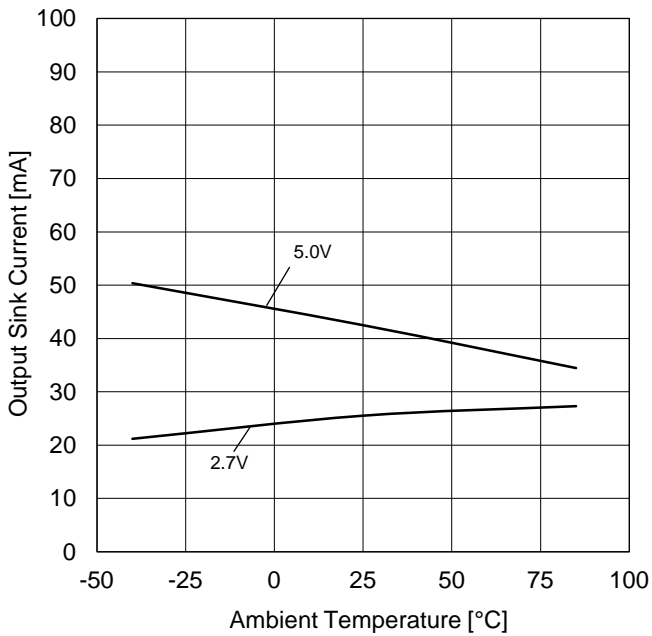

Figure 55. Output Sink Current vs Ambient Temperature

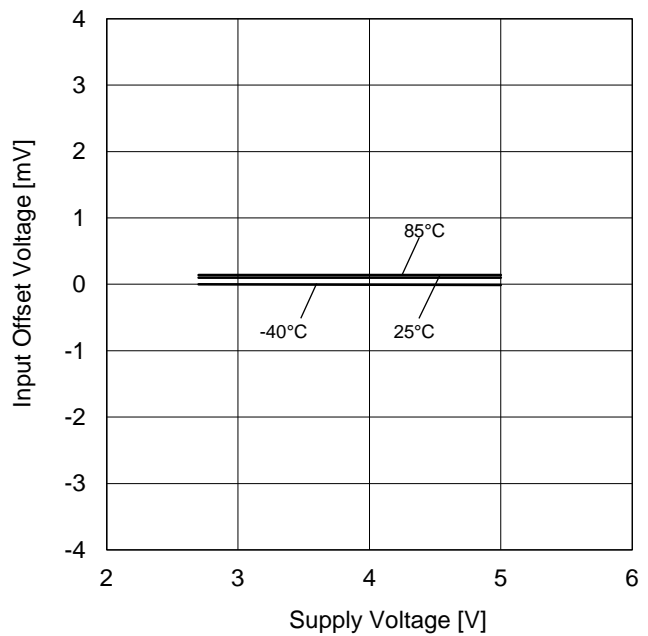

Figure 56. Input Offset Voltage vs Supply Voltage ($V_{ICM}=V_{DD}/2$, $E_K=-V_{DD}/2$)

(*)The data above are measurement values of a typical sample, it is not guaranteed.

Typical Performance Curves – continued
OLMR824xxx

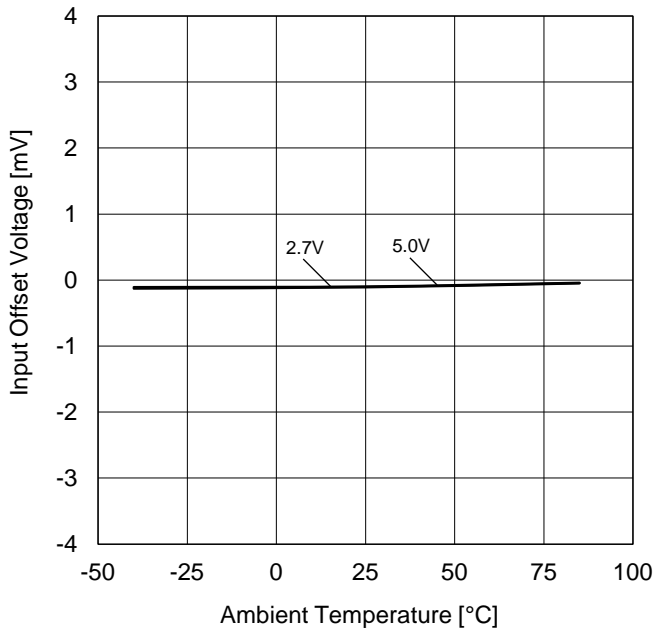

Figure 57. Input Offset Voltage vs Ambient Temperature ($V_{ICM}=V_{DD}/2$, $E_K=-V_{DD}/2$)

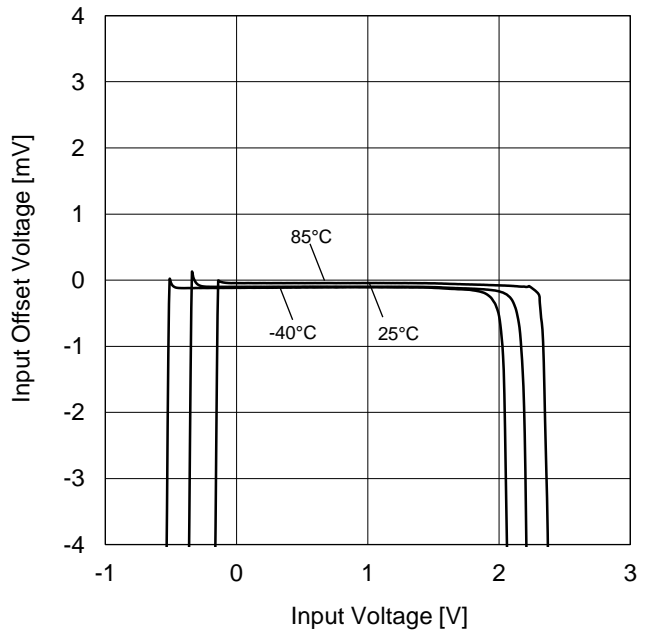

Figure 58. Input Offset Voltage vs Input Voltage ($V_{DD}=2.7V$)

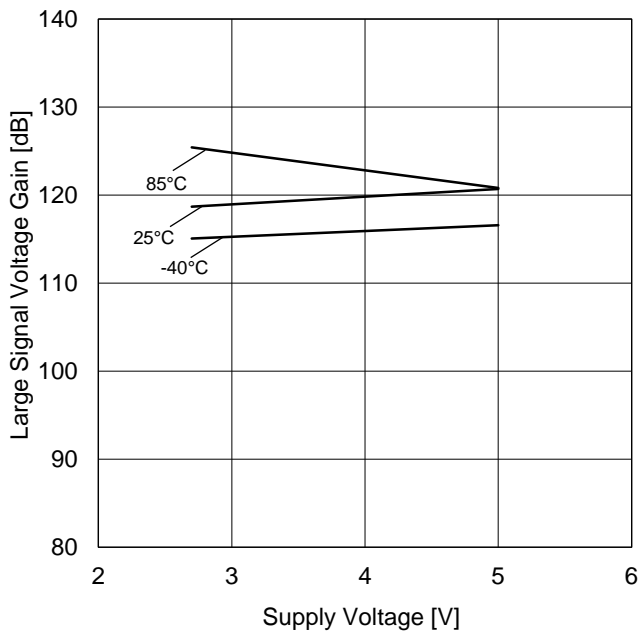

Figure 59. Large Signal Voltage Gain vs Supply Voltage

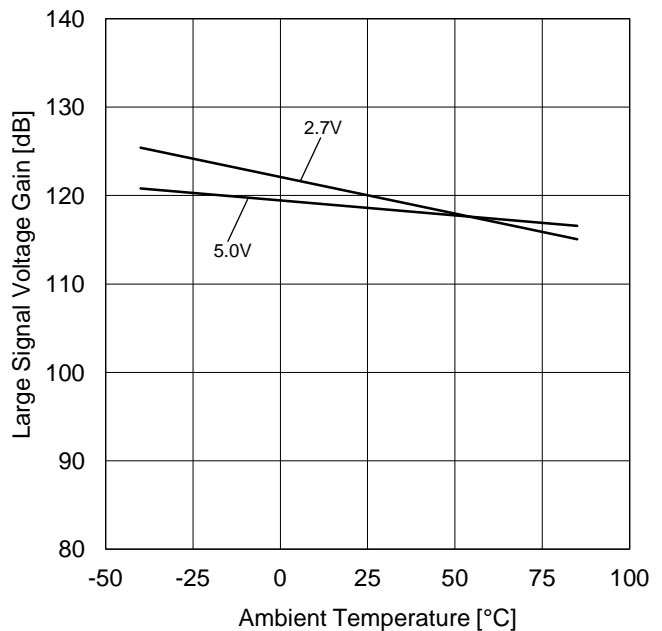

Figure 60. Large Signal Voltage Gain vs Ambient Temperature

(*)The data above are measurement values of a typical sample, it is not guaranteed.

Typical Performance Curves – continued
OLMR824xxx

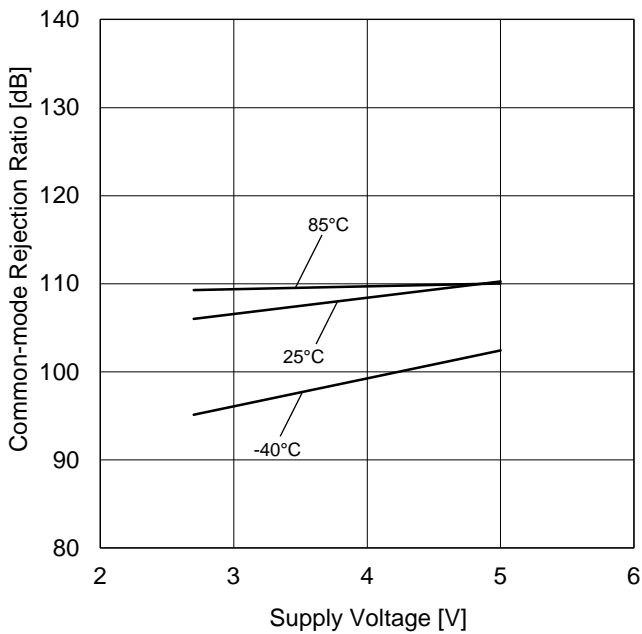

Figure 61. Common-mode Rejection Ratio vs Supply Voltage ($V_{DD}=2.7V$)

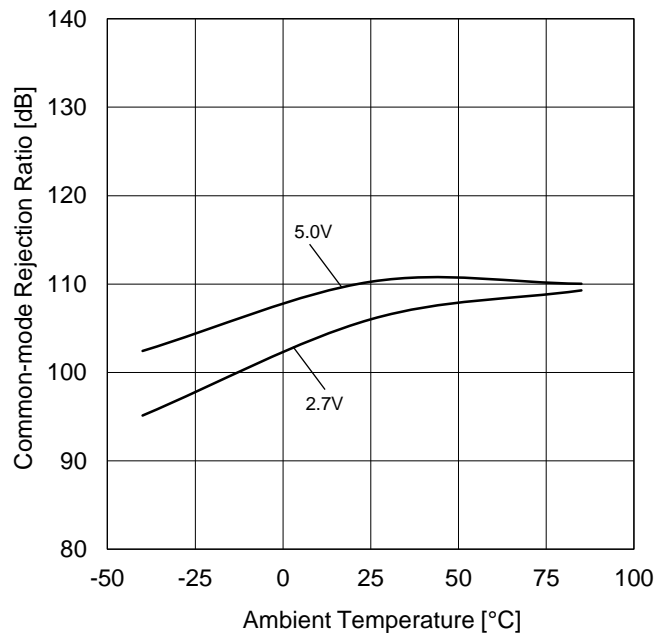

Figure 62. Common-mode Rejection Ratio vs Ambient Temperature

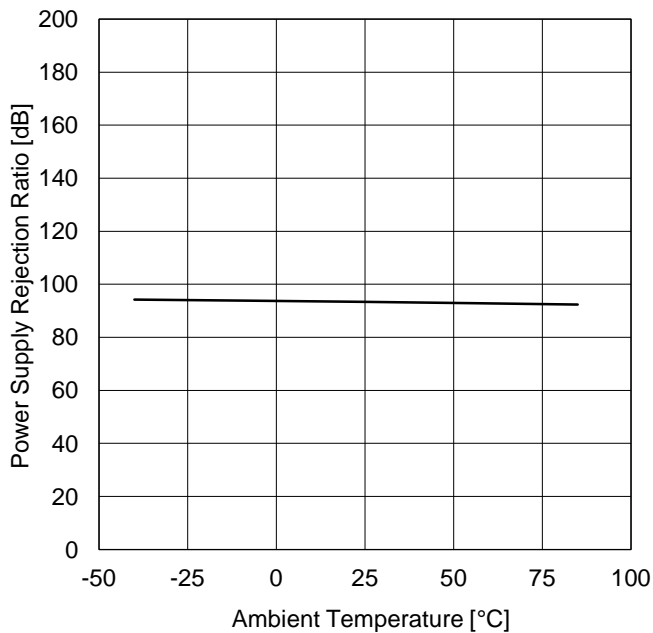

Figure 63. Power Supply Rejection Ratio vs Ambient Temperature ($V_{DD}=2.7V$ to $5.0V$)

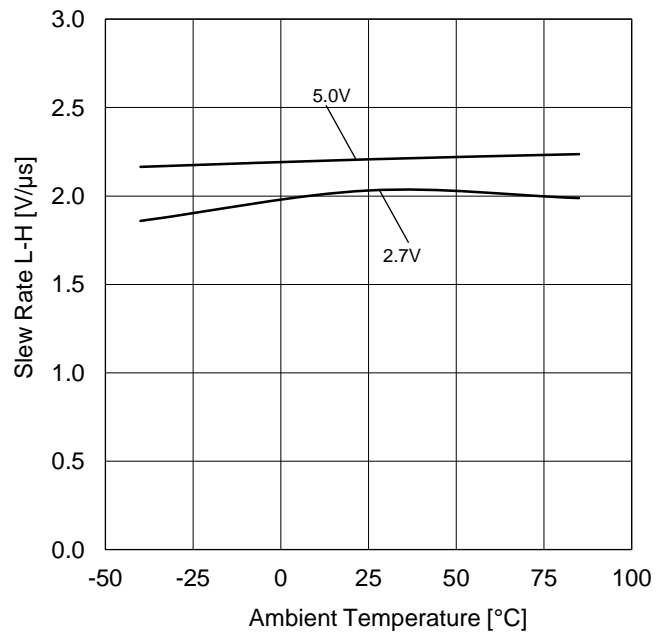

Figure 64. Slew Rate L-H vs Ambient Temperature

(*)The data above are measurement values of a typical sample, it is not guaranteed.

Typical Performance Curves – continued
OLMR824xxx

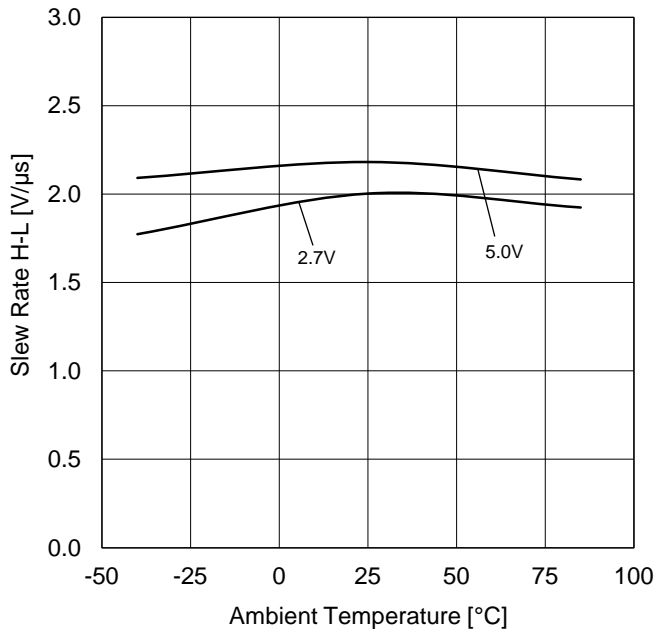

Figure 65. Slew Rate H-L vs Ambient Temperature

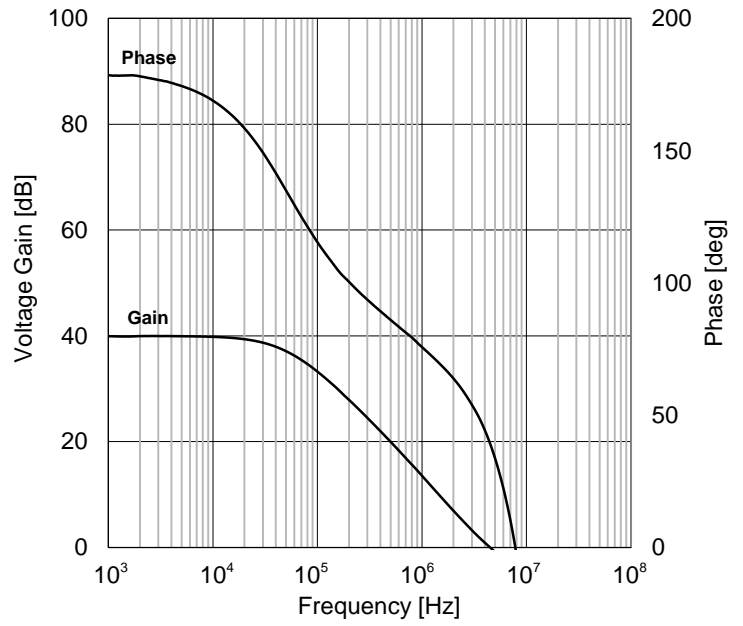

Figure 66. Voltage Gain · Phase vs Frequency

(*)The data above are measurement values of a typical sample, it is not guaranteed.

Application Information

NULL method condition for Test Circuit 1

V_{DD}, V_{SS}, E_K, V_{ICM} Unit:V

| Parameter | V _F | S1 | S2 | S3 | V _{DD} | V _{SS} | E _K | V _{ICM} | Calculation |
|---|-----------------|----|----|-----|-----------------|-----------------|----------------|------------------|-------------|
| Input Offset Voltage | V _{F1} | ON | ON | OFF | 5 | 0 | -2.5 | 2.5 | 1 |
| Large Signal Voltage Gain | V _{F2} | ON | ON | ON | 2.7 | 0 | -0.5 | 1.35 | 2 |
| | V _{F3} | | | | | | -2.1 | | |
| Common-mode Rejection Ratio (Input Common-mode Voltage Range) | V _{F4} | ON | ON | OFF | 2.7 | 0 | -1.35 | 0 | 3 |
| | V _{F5} | | | | | | -1.35 | 1.8 | |
| Power Supply Rejection Ratio | V _{F6} | ON | ON | OFF | 2.5 | 0 | -1.2 | 0 | 4 |
| | V _{F7} | | | | 5.0 | | | | |

— Calculation—

1. Input Offset Voltage (V_{IO})
$$V_{IO} = \frac{|V_{F1}|}{1+R_F/R_S} \quad [V]$$

2. Large Signal Voltage Gain (A_v)
$$A_v = 20\text{Log} \frac{\Delta E_K \times (1+R_F/R_S)}{|V_{F2}-V_{F3}|} \quad [\text{dB}]$$

3. Common-mode Rejection Ratio (CMRR)
$$\text{CMRR} = 20\text{Log} \frac{\Delta V_{ICM} \times (1+R_F/R_S)}{|V_{F4} - V_{F5}|} \quad [\text{dB}]$$

4. Power Supply Rejection Ratio (PSRR)
$$\text{PSRR} = 20\text{Log} \frac{\Delta V_{DD} \times (1+R_F/R_S)}{|V_{F6} - V_{F7}|} \quad [\text{dB}]$$

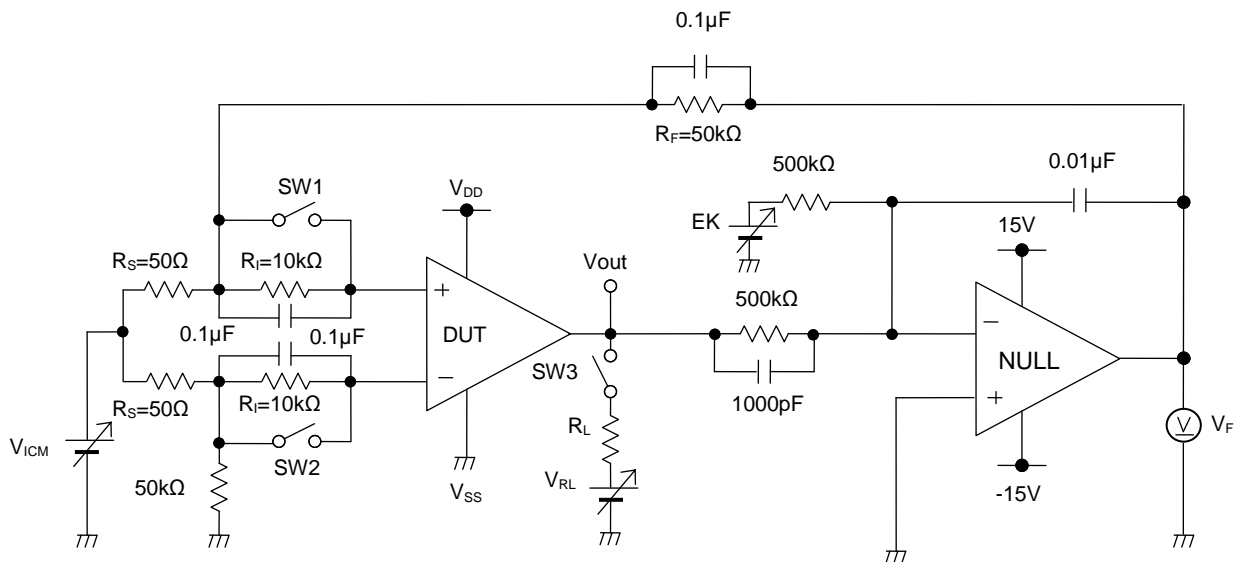

Figure 67. Test Circuit1

Application Information - continued
Switch Condition for Test Circuit 2

| SW No. | SW1 | SW2 | SW3 | SW4 | SW5 | SW6 | SW7 | SW8 | SW9 | SW10 | SW11 | SW12 |
|--|-----|-----|-----|-----|-----|-----|-----|-----|-----|------|------|------|
| Supply Current | OFF | OFF | ON | OFF | ON | OFF | OFF | OFF | OFF | OFF | OFF | OFF |
| Maximum Output Voltage $R_L=10k\Omega$ | OFF | ON | OFF | OFF | ON | OFF | OFF | ON | OFF | OFF | ON | OFF |
| Output Current | OFF | ON | OFF | OFF | ON | OFF | OFF | OFF | OFF | ON | OFF | OFF |
| Slew Rate | OFF | OFF | ON | OFF | OFF | OFF | ON | OFF | ON | OFF | OFF | ON |
| Unity Gain Frequency | ON | OFF | OFF | ON | ON | OFF | OFF | OFF | ON | OFF | OFF | ON |

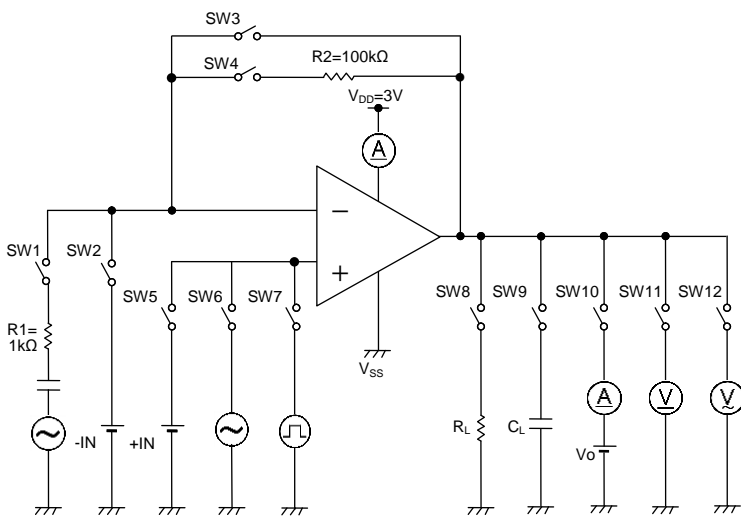

Figure 68. Test Circuit 2

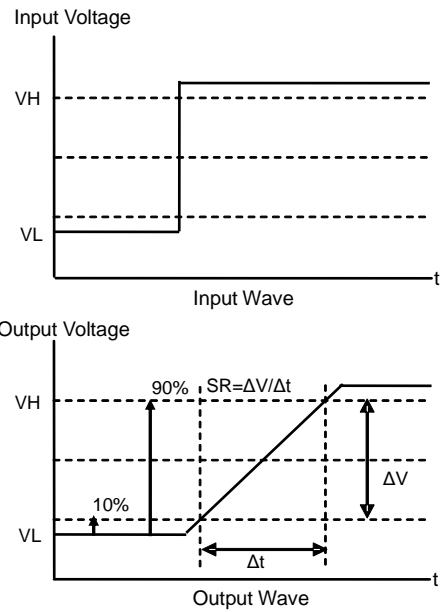

Figure 69. Slew Rate Input and Output Wave

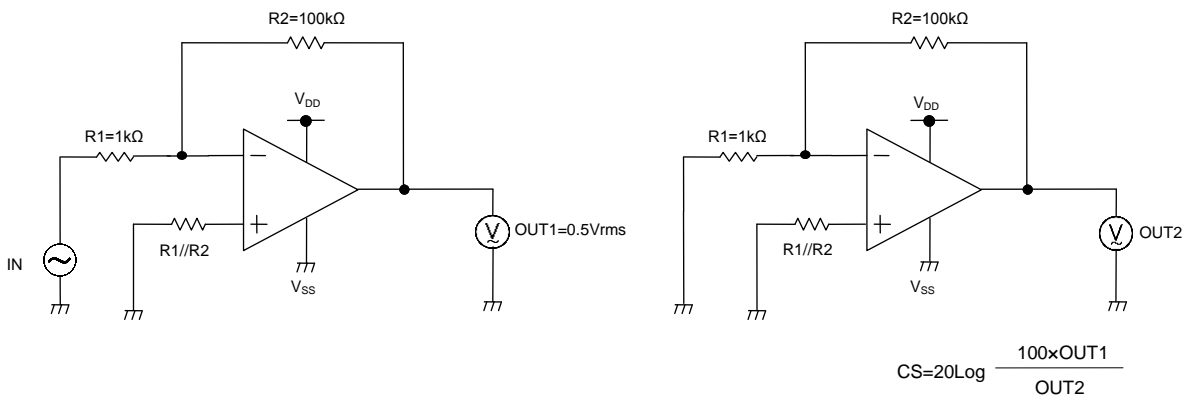

Figure 70. Test Circuit 3 (Channel Separation)

Application Example

○Voltage Follower

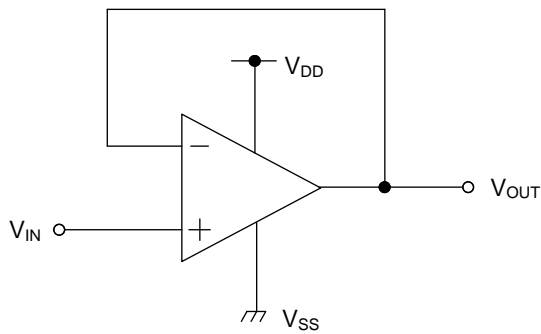

Figure 71. Voltage Follower

Voltage gain is 0dB.

Using this circuit, the output voltage (V_{OUT}) is configured to be equal to the input voltage (V_{IN}). This circuit also stabilizes the output voltage (V_{OUT}) due to high input impedance and low output impedance. Computation for output voltage (V_{OUT}) is shown below.

$$V_{OUT}=V_{IN}$$

○Inverting Amplifier

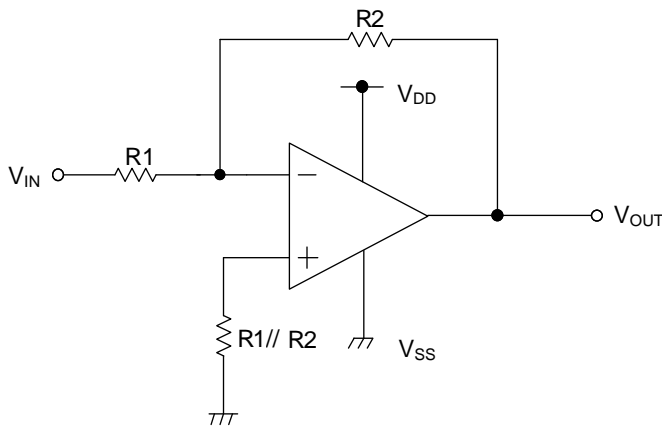

Figure 72. Inverting Amplifier Circuit

For inverting amplifier, input voltage (V_{IN}) is amplified by a voltage gain and depends on the ratio of $R1$ and $R2$. The out-of-phase output voltage is shown in the next expression

$$V_{OUT}=-\left(\frac{R2}{R1}\right) \cdot V_{IN}$$

This circuit has input impedance equal to $R1$.

○Non-inverting Amplifier

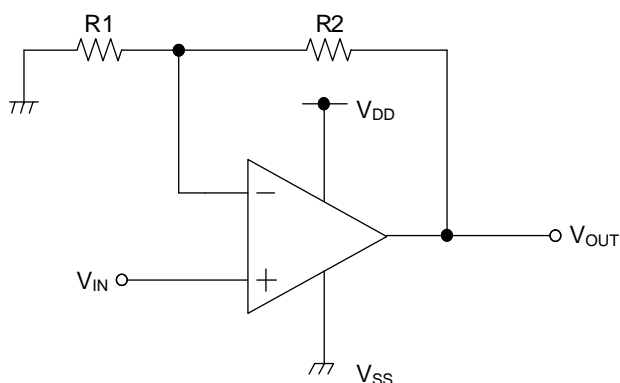

Figure 73. Non-inverting Amplifier Circuit

For non-inverting amplifier, input voltage (IN) is amplified by a voltage gain, which depends on the ratio of $R1$ and $R2$. The output voltage (OUT) is in-phase with the input voltage (IN) and is shown in the expression below:

$$V_{OUT}=\left(1 + \frac{R2}{R1}\right) \cdot V_{IN}$$

Effectively, this circuit has high input impedance since its input side is the same as that of the operational amplifier.

Power Dissipation

Power dissipation (total loss) indicates the power that the IC can consume at $T_A=25^\circ\text{C}$ (normal temperature). As the IC consumes power, it heats up, causing its temperature to rise above the ambient temperature. There is an allowable temperature that the IC can handle, and this depends on the circuit configuration, manufacturing process, and consumable power.

Power dissipation is determined by the allowable temperature within the IC (maximum junction temperature) and the thermal resistance of the package used (heat dissipation capability). Maximum junction temperature is typically equal to the maximum storage temperature. The heat generated through the consumption of power by the IC radiates from the mold resin or lead frame of the package. Thermal resistance, represented by the symbol $\theta_{JA}^\circ\text{C/W}$, indicates this heat dissipation capability. Similarly, the temperature of an IC inside its package can be estimated by thermal resistance.

Figure 74(a) shows the model of the thermal resistance of a package. The equation below shows how to compute for the Thermal resistance (θ_{JA}), given the ambient temperature (T_A), maximum junction temperature (T_{Jmax}), and power dissipation (P_d).

$$\theta_{JA} = (T_{Jmax} - T_A) / P_d \quad ^\circ\text{C/W}$$

The derating curve in Figure 74(b) indicates the power that the IC can consume with reference to ambient temperature. Power consumption of the IC begins to attenuate at certain temperatures. This gradient is determined by thermal resistance (θ_{JA}), which depends on the chip size, power consumption, package, ambient temperature, package condition, wind velocity, etc. This may also vary even when the same package is used. Thermal reduction curve indicates a reference value measured at a specified condition. Figures 74(c), 74(d), and 74(e) show the example of the derating curves for LMR821G, LMR822xxx, and LMR824xxx.

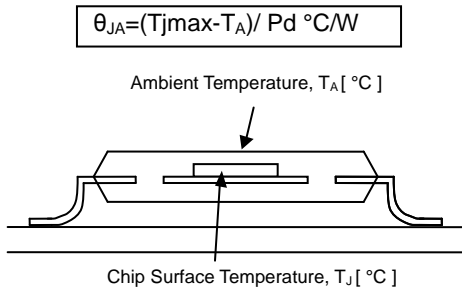

(a) Thermal Resistance

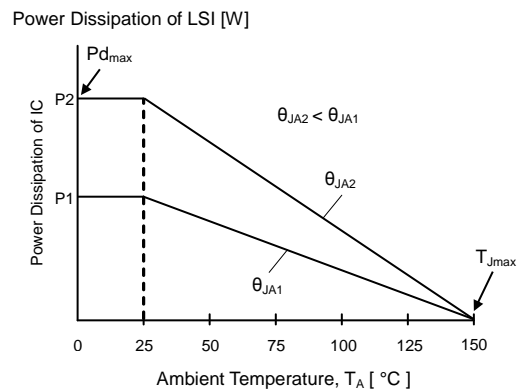

(b) Derating Curve

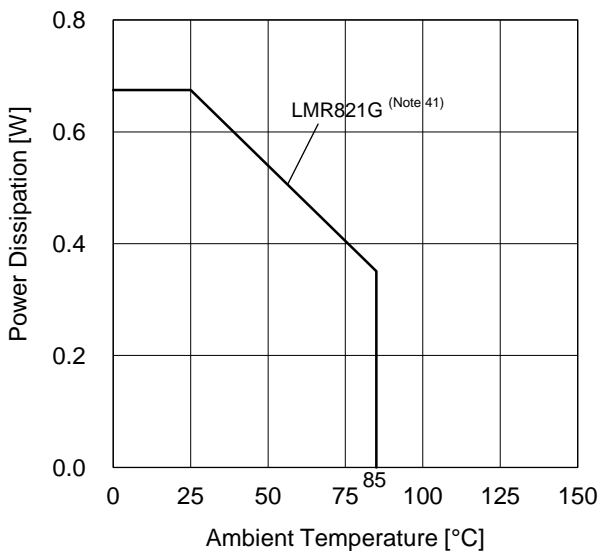

(c) LMR821G

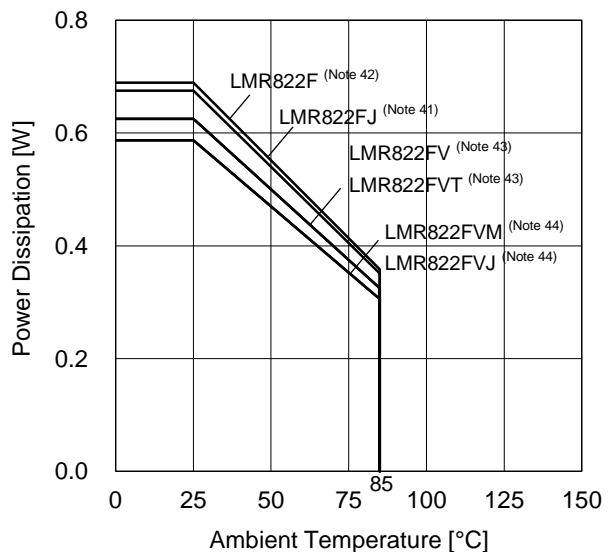

(d) LMR822xxx

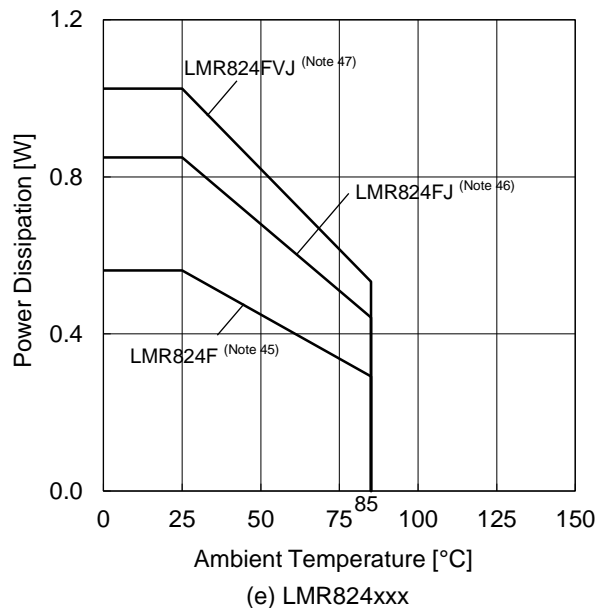

Figure 74. Thermal Resistance and Derating Curve

| (Note 41) | (Note 42) | (Note 43) | (Note 44) | (Note 45) | (Note 46) | (Note 47) | Unit |
|-----------|-----------|-----------|-----------|-----------|-----------|-----------|-------|
| 5.4 | 5.5 | 5.0 | 4.7 | 4.5 | 8.2 | 6.8 | mW/°C |

When using

the unit above $T_A=25^{\circ}\text{C}$, subtract the value above per $^{\circ}\text{C}$. Power dissipation is the value when FR4 glass epoxy board $70\text{mm} \times 70\text{mm} \times 1.6\text{mm}$ (copper foil area below 3%) is mounted.

Operational Notes

1. Reverse Connection of Power Supply

Connecting the power supply in reverse polarity can damage the IC. Take precautions against reverse polarity when connecting the power supply, such as mounting an external diode between the power supply and the IC's power supply pins.

2. Power Supply Lines

Design the PCB layout pattern to provide low impedance supply lines. Separate the ground and supply lines of the digital and analog blocks to prevent noise in the ground and supply lines of the digital block from affecting the analog block. Furthermore, connect a capacitor to ground at all power supply pins. Consider the effect of temperature and aging on the capacitance value when using electrolytic capacitors.

3. Ground Voltage

Ensure that no pins are at a voltage below that of the ground pin at any time, even during transient condition.

4. Ground Wiring Pattern

When using both small-signal and large-current ground traces, the two ground traces should be routed separately but connected to a single ground at the reference point of the application board to avoid fluctuations in the small-signal ground caused by large currents. Also ensure that the ground traces of external components do not cause variations on the ground voltage. The ground lines must be as short and thick as possible to reduce line impedance.

5. Thermal Consideration

A rise in temperature that causes the chip to exceed its power dissipation rating may result in deterioration of the properties of the chip. The absolute maximum rating of the P_D stated in this specification is when the IC is mounted on a 70mm x 70mm x 1.6mm glass epoxy board. In case the absolute maximum rating is exceeded, increase the board size and copper area to prevent exceeding the P_D rating.

6. Recommended Operating Conditions

These conditions represent a range within which the expected characteristics of the IC can be approximately obtained. The electrical characteristics are guaranteed under the conditions of each parameter.

7. In-rush Current

When power is first supplied to the IC, it is possible that the internal logic may be unstable and inrush current may flow instantaneously due to the internal powering sequence and delays, especially if the IC has more than one power supply. Therefore, give special consideration to power coupling capacitance, power wiring, width of ground wiring, and routing of connections.

8. Operation Under Strong Electromagnetic Field

Operating the IC in the presence of a strong electromagnetic field may cause the IC to malfunction.

9. Testing on Application Boards

When testing the IC on an application board, connecting a capacitor directly to a low-impedance output pin may subject the IC to stress. Always discharge capacitors completely after each process or step. The IC's power supply should always be turned off completely before connecting or removing it from the test setup during the inspection process. To prevent damage from static discharge, ground the IC during assembly and use similar precautions during transport and storage.

10. Inter-pin Short and Mounting Errors

Ensure that the direction and position are correct when mounting the IC on the PCB. Incorrect mounting may result to IC damage. Avoid adjacent pins from being shorted to each other, especially to ground, power supply and output pin. Inter-pin shorts could be due to many reasons such as metal particles, water droplets (in a very humid environment), and unintentional solder bridge deposited in between pins during assembly.

Operational Notes – continued

11. Regarding the Input Pin of the IC

This monolithic IC contains P+ isolation and P substrate layers between adjacent elements in order to keep them isolated. P-N junctions are formed at the intersection of the P layers with the N layers of other elements, creating a parasitic diode or transistor. For example (refer to figure below):

When $V_{SS} > \text{Pin A}$ and $V_{SS} > \text{Pin B}$, the P-N junction operates as a parasitic diode.
 When $V_{SS} > \text{Pin B}$, the P-N junction operates as a parasitic transistor.

Parasitic diodes inevitably occur in the structure of the IC. The operation of parasitic diodes can result in mutual interference among circuits, operational faults, or physical damage. Therefore, conditions that cause these diodes to operate, such as applying a voltage lower than the VSS voltage to an input pin (and thus to the P substrate) should be avoided.

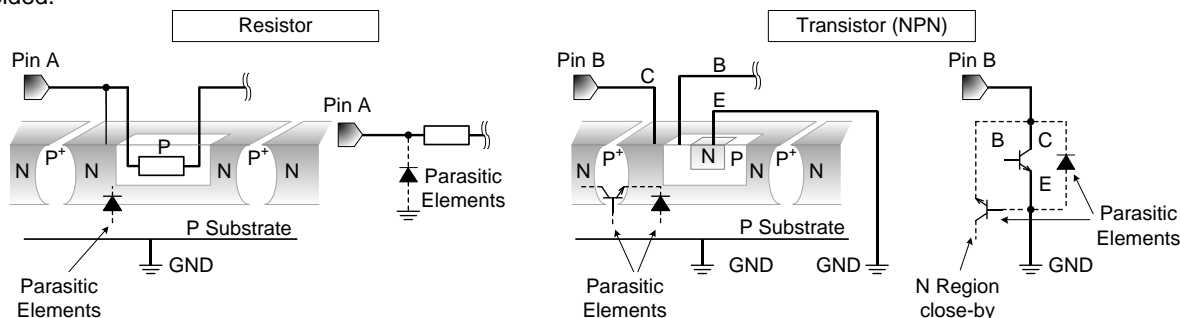

Figure 75. Example of Monolithic IC Structure

12. Unused Circuits

When there are unused op-amps, it is recommended that they are connected as in Figure 76, setting the non-inverting input terminal to a potential within the $-IN$ phase input voltage range (V_{ICM}).

13. Input Voltage

Applying $V_{SS}-0.3V$ to $V_{DD}+0.3V$ to the input terminal is possible without causing deterioration of the electrical characteristics or destruction. However, this does not ensure normal circuit operation. Please note that the circuit operates normally only when the input voltage is within the common mode input voltage range of the electric characteristics.

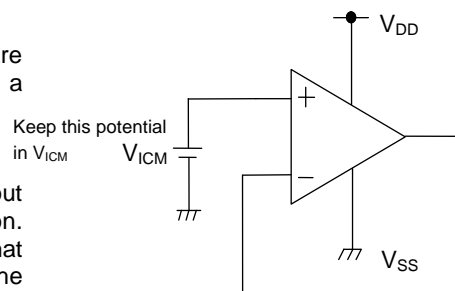

Figure 76. Example of Application Circuit for Unused Op-Amp

14. Power Supply (Single/Dual)

The operational amplifiers operate as long as voltage is supplied between V_{DD} and V_{SS} . Therefore, the single supply operational amplifiers can be used as dual supply operational amplifiers as well.

15. Output Capacitor

If a large capacitor is connected between the output pin and V_{SS} pin, current from the charged capacitor will flow into the output pin and may destroy the IC when the V_{CC} pin is shorted to ground or pulled down to $0V$. Use a capacitor smaller than $0.1\mu F$ between output pin and V_{SS} pin.

16. Oscillation by Output Capacitor

Pay attention to the oscillation by caused by the output capacitor and in designing an application of negative feedback loop circuit with these ICs.

17. Latch-up

Be careful not to set the input voltage higher than V_{DD} or lower than V_{SS} because a peculiar latch-up state in CMOS device might occur. In addition, protect the IC from any abnormal noise.

18. Decoupling Capacitor

Insert a decoupling capacitor between V_{DD} and V_{SS} .

Physical Dimension, Tape and Reel Information

| | |
|--------------|-------|
| Package Name | SSOP5 |
|--------------|-------|

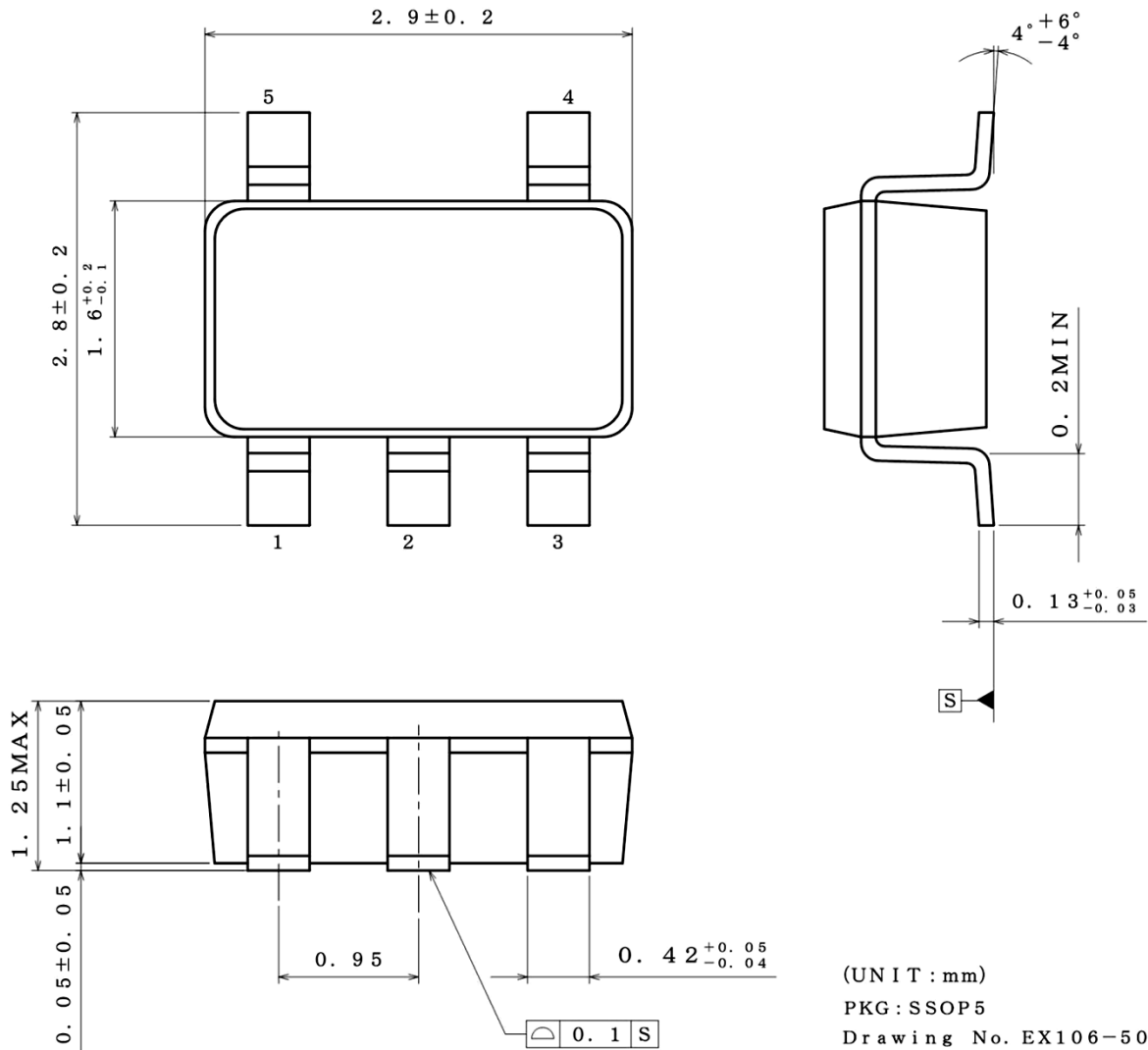

< Tape and Reel Information >

| | |
|-------------------|---|
| Tape | Embossed carrier tape |
| Quantity | 3000pcs |
| Direction of feed | TR (The direction is the 1pin of product is at the upper right when you hold) reel on the left hand and you pull out the tape on the right hand |

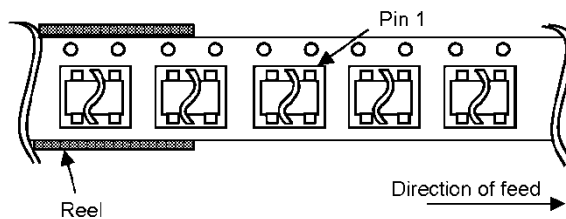

Physical Dimension, Tape and Reel Information – continued

| | |
|--------------|------|
| Package Name | SOP8 |
|--------------|------|

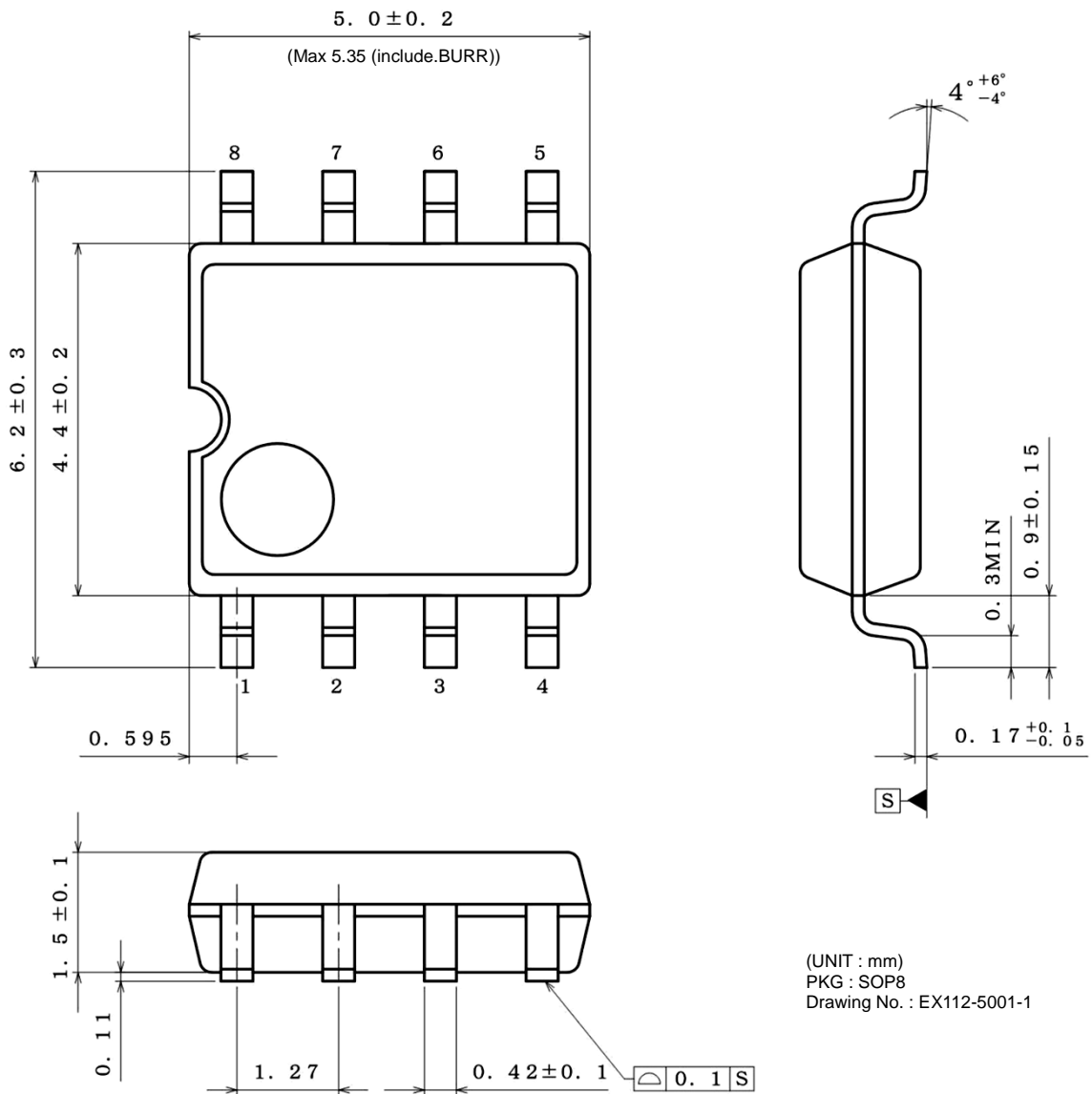

(UNIT : mm)
 PKG : SOP8
 Drawing No. : EX112-5001-1

<Tape and Reel information>

| | |
|-------------------|---|
| Tape | Embossed carrier tape |
| Quantity | 2500pcs |
| Direction of feed | E2 (The direction is the 1pin of product is at the upper left when you hold reel on the left hand and you pull out the tape on the right hand) |

Reel

1pin

Direction of feed

*Order quantity needs to be multiple of the minimum quantity.

Physical Dimension, Tape and Reel Information – continued

| | |
|--------------|--------|
| Package Name | SOP-J8 |
|--------------|--------|

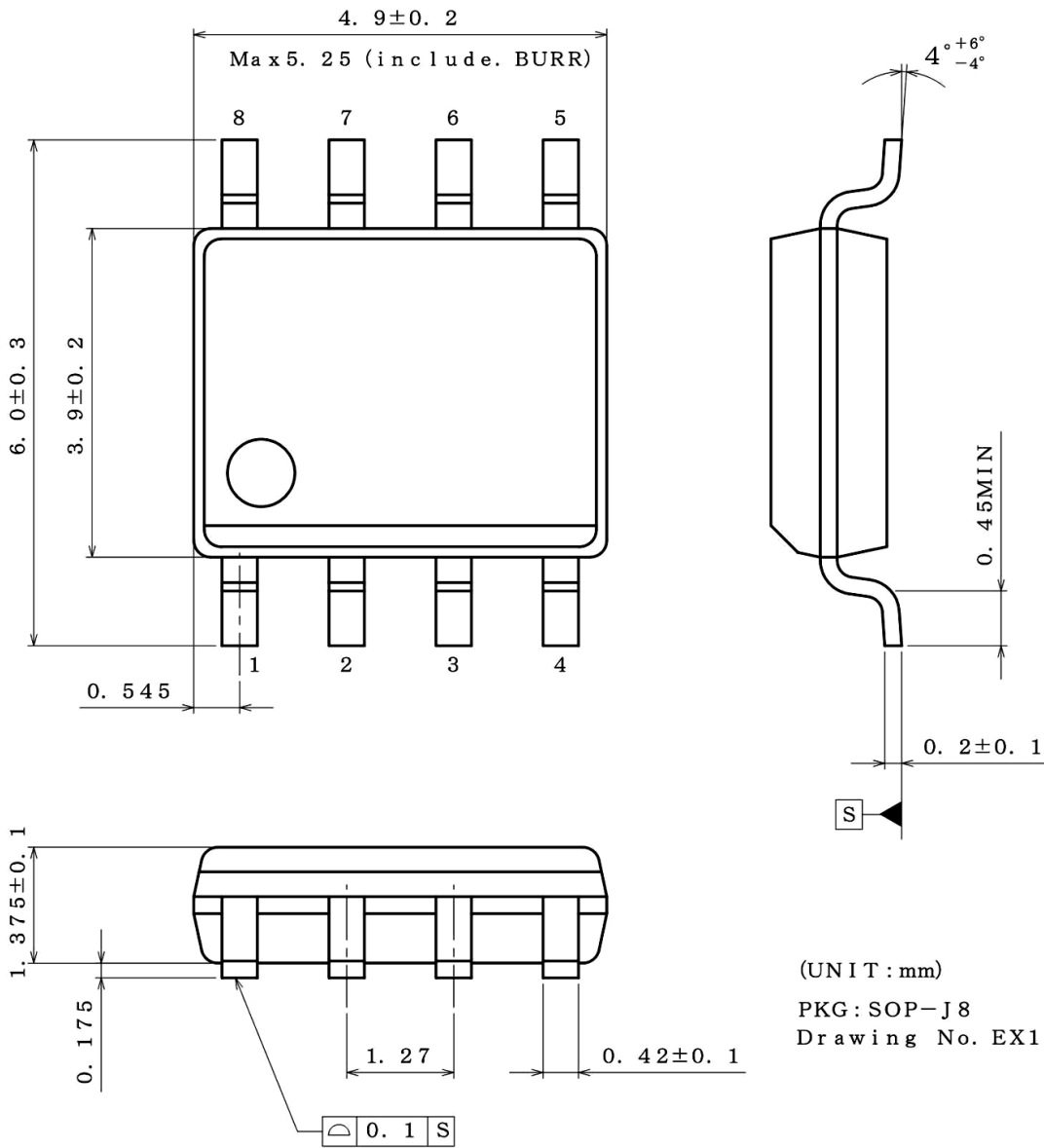

(UNIT : mm)
 PKG : SOP-J8
 Drawing No. EX111-5002

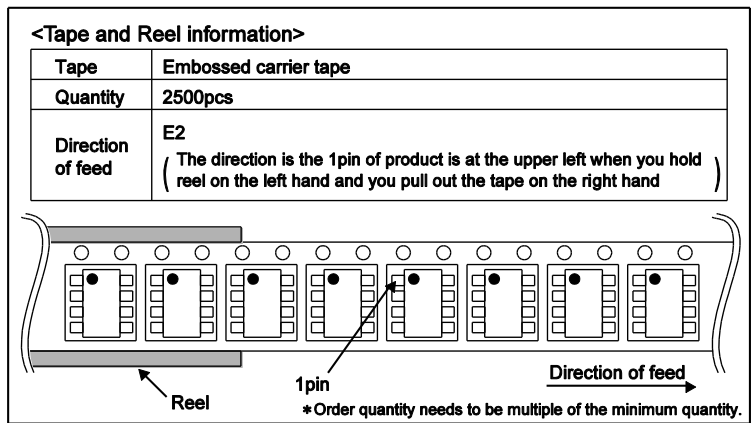

Physical Dimension, Tape and Reel Information – continued

| | |
|--------------|---------|
| Package Name | SSOP-B8 |
|--------------|---------|

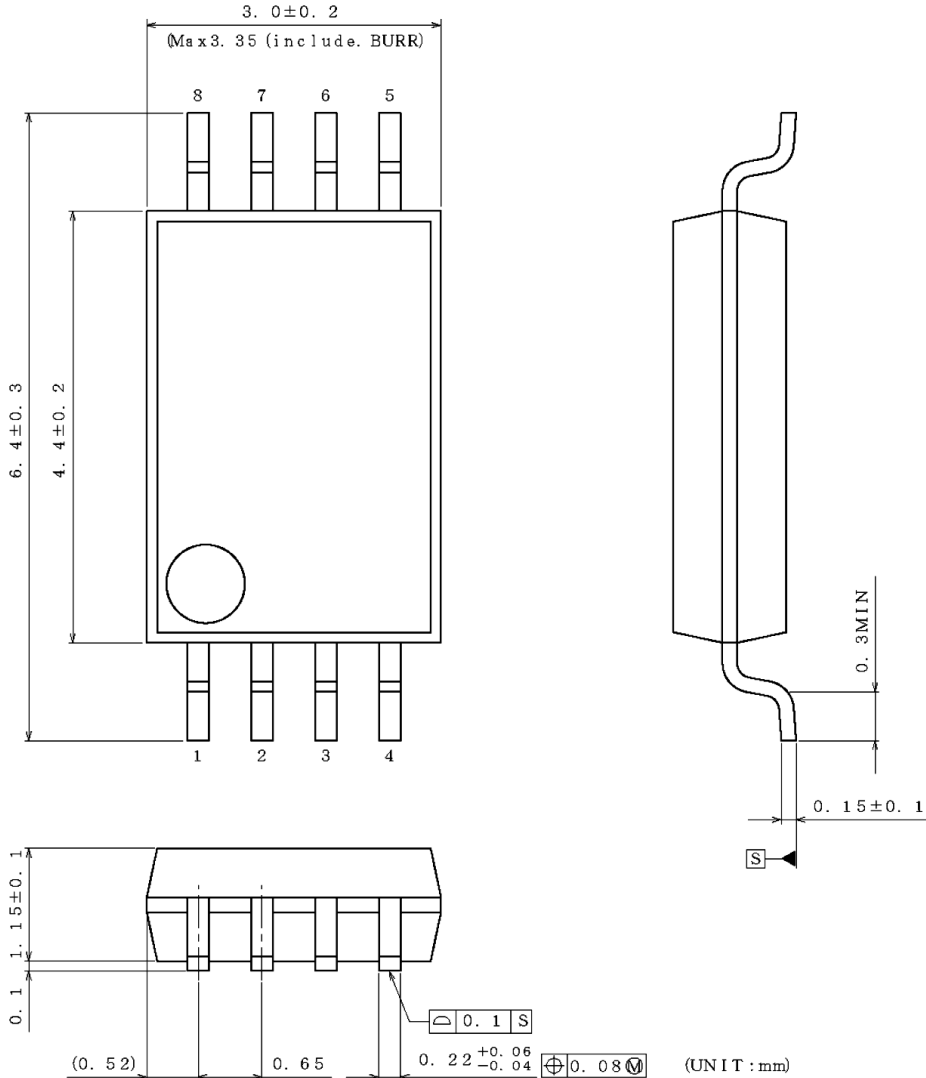

(UNIT : mm)
 PKG : SSOP-B8
 Drawing No. EX151-5002

<Tape and Reel information>

| | |
|-------------------|---|
| Tape | Embossed carrier tape |
| Quantity | 2500pcs |
| Direction of feed | E2 (The direction is the 1pin of product is at the upper left when you hold reel on the left hand and you pull out the tape on the right hand) |

Reel → 1pin → Direction of feed →

* Order quantity needs to be multiple of the minimum quantity.

Physical Dimension, Tape and Reel Information – continued

| | |
|--------------|----------|
| Package Name | TSSOP-B8 |
|--------------|----------|

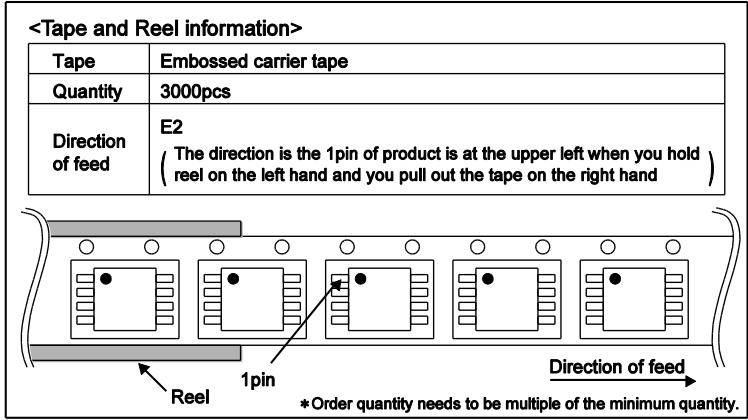
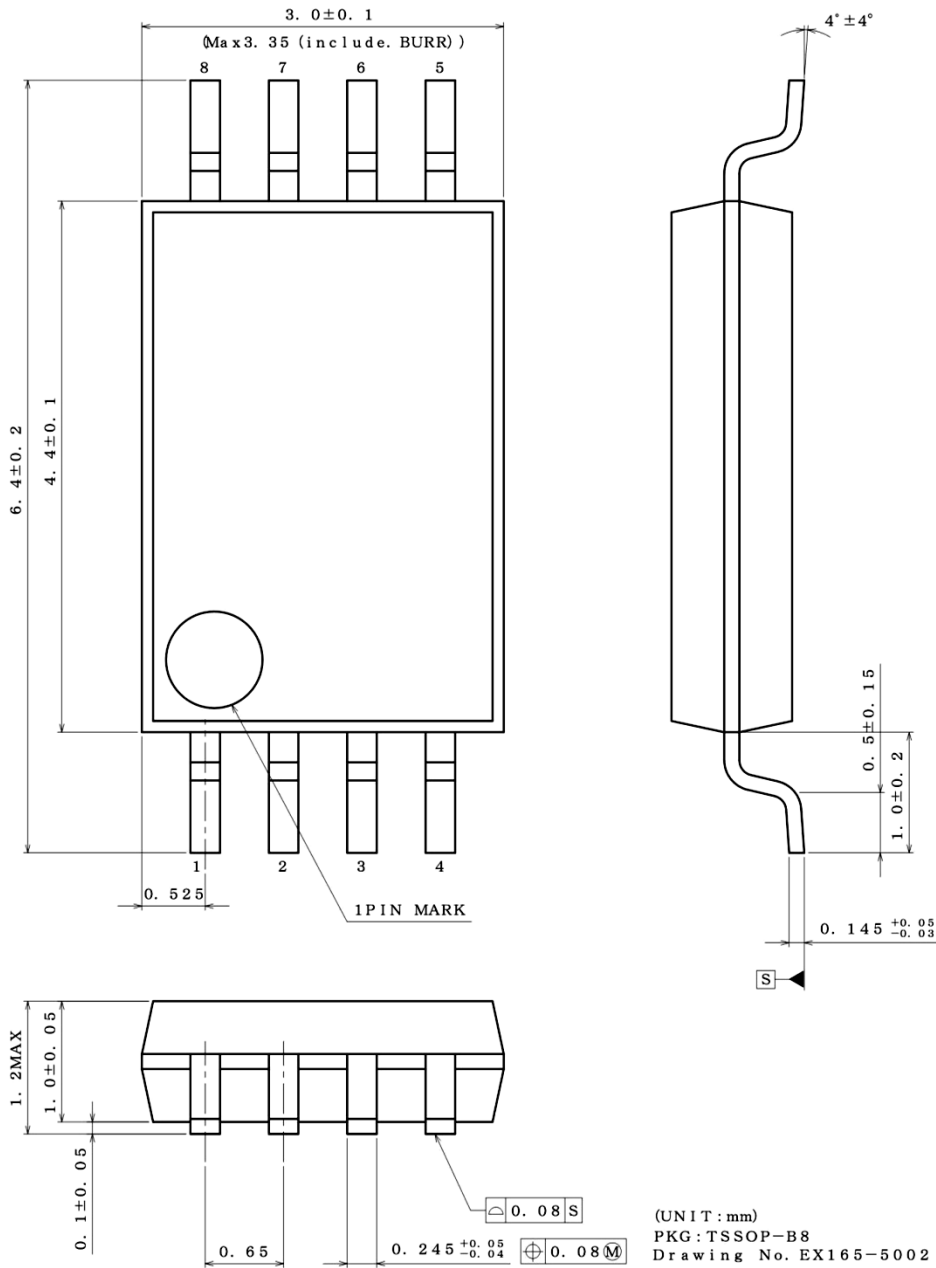

Physical Dimension, Tape and Reel Information – continued

| | |
|--------------|-------|
| Package Name | MSOP8 |
|--------------|-------|

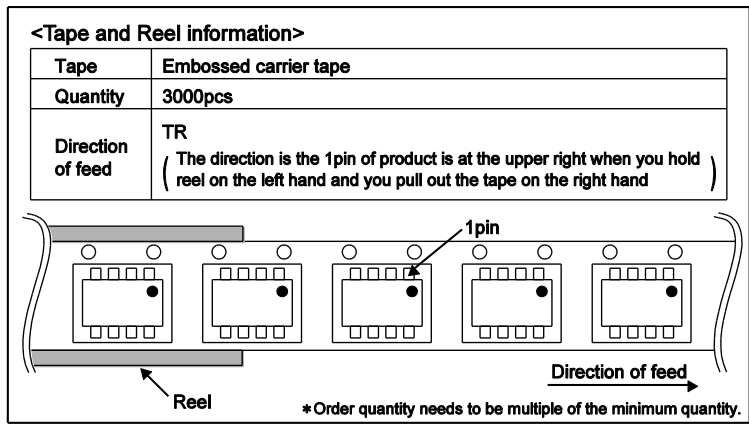
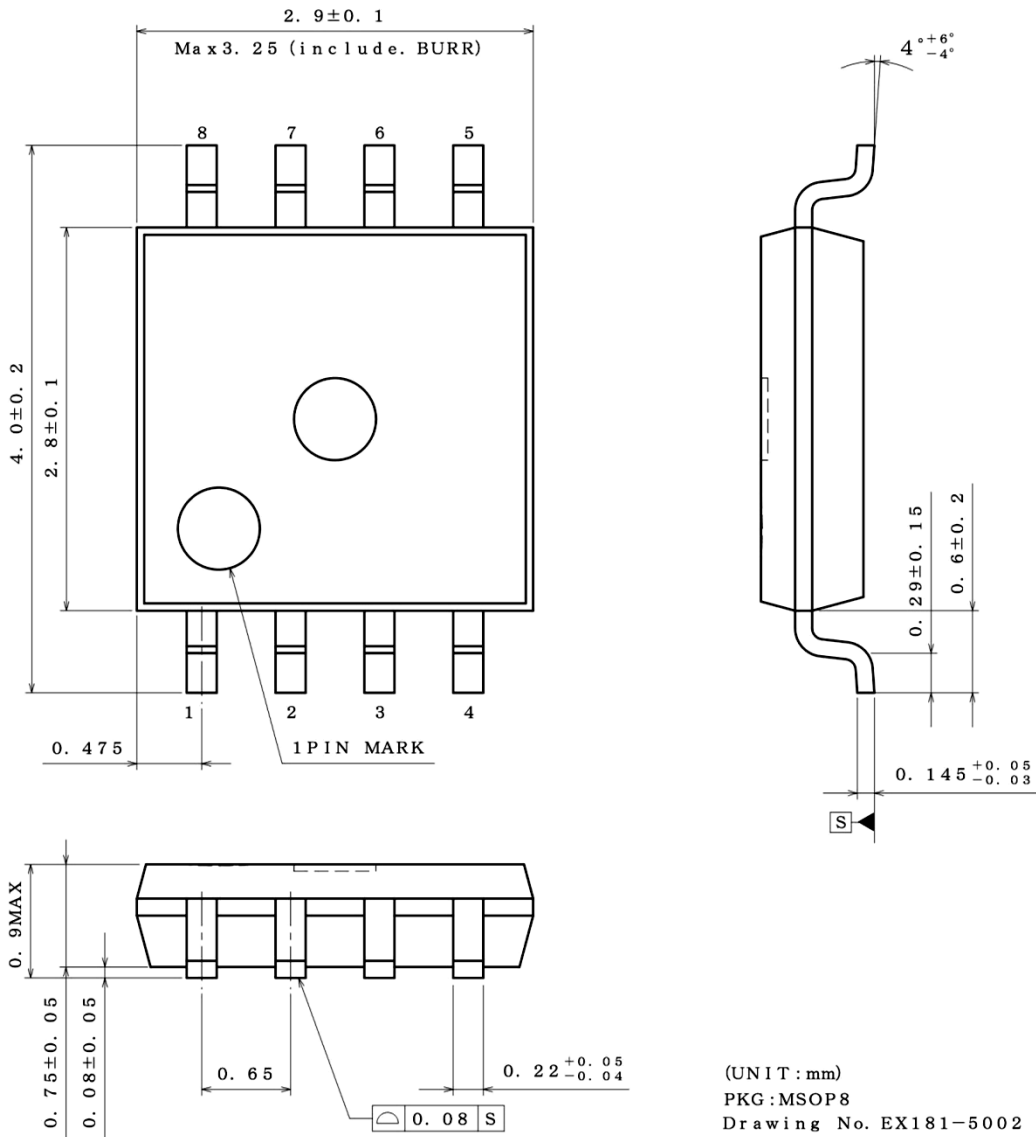

Physical Dimension, Tape and Reel Information – continued

| | |
|--------------|-----------|
| Package Name | TSSOP-B8J |
|--------------|-----------|

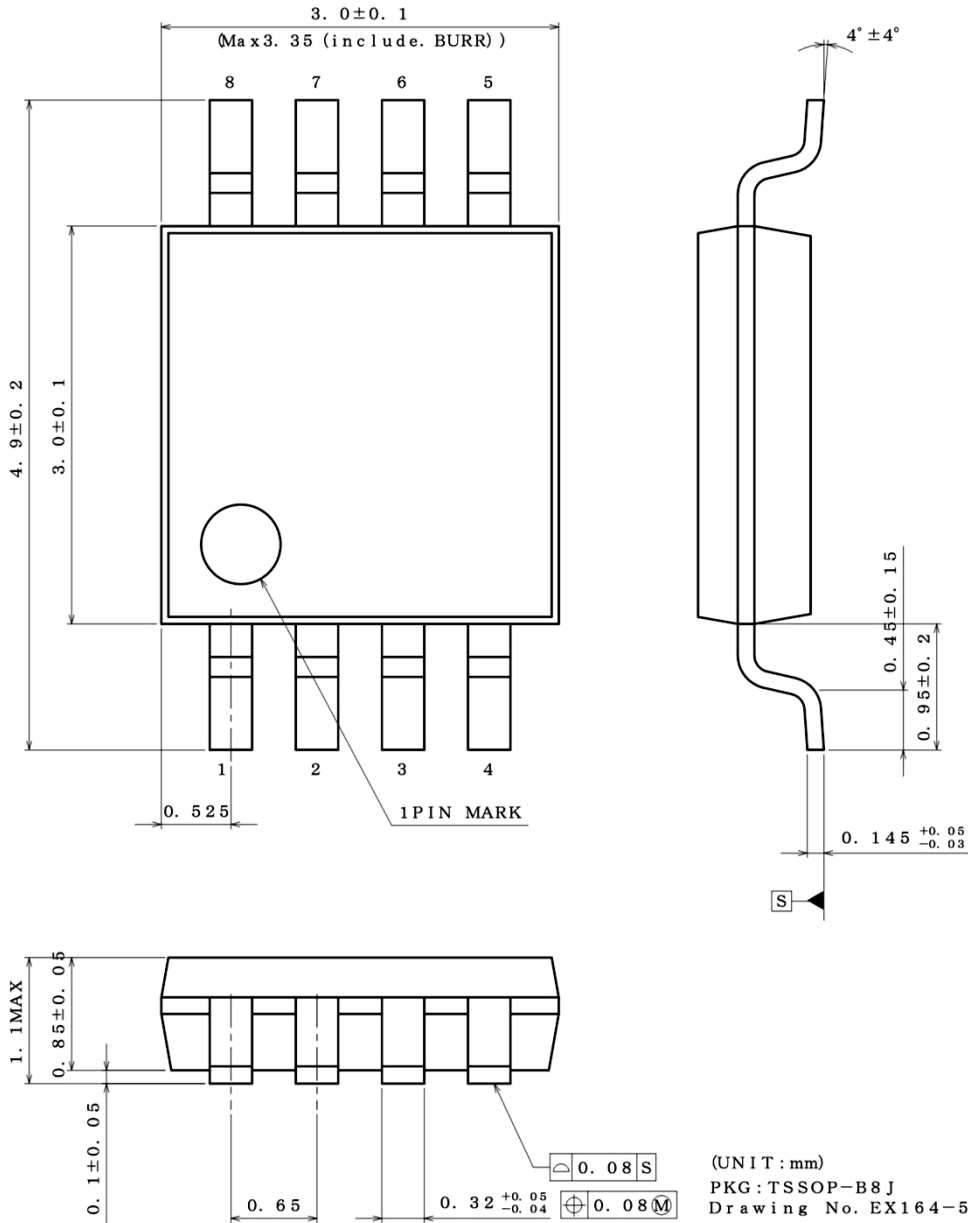

<Tape and Reel information>

| | |
|-------------------|---|
| Tape | Embossed carrier tape |
| Quantity | 2500pcs |
| Direction of feed | E2 (The direction is the 1pin of product is at the upper left when you hold reel on the left hand and you pull out the tape on the right hand) |

Reel 1pin Direction of feed

*Order quantity needs to be multiple of the minimum quantity.

Physical Dimension, Tape and Reel Information – continued

| | |
|--------------|-------|
| Package Name | SOP14 |
|--------------|-------|

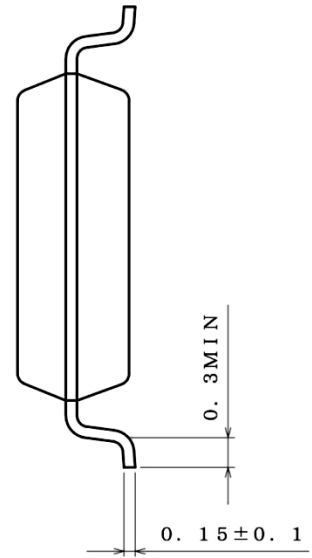
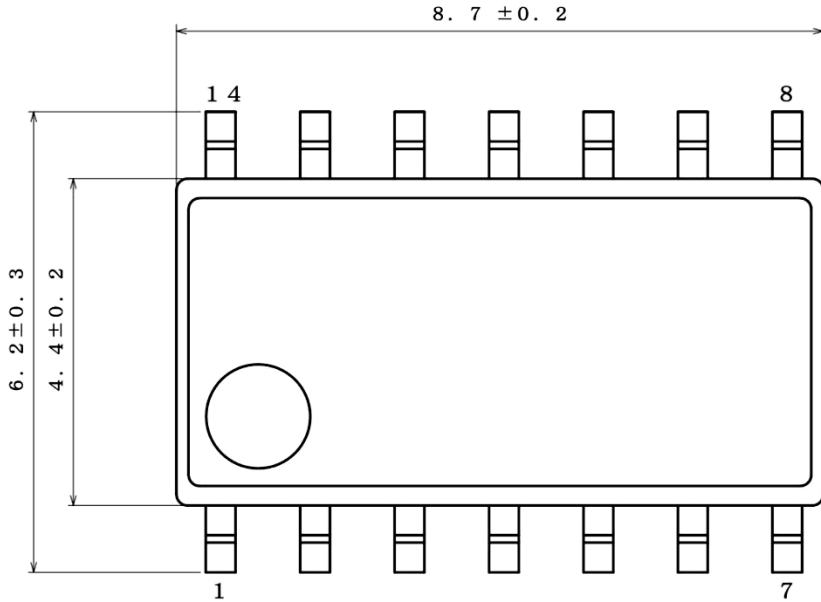

(UNIT : mm)
 PKG : SOP14
 Drawing No. : EX113-5001

<Tape and Reel information>

| | |
|-------------------|---|
| Tape | Embossed carrier tape |
| Quantity | 2500pcs |
| Direction of feed | E2 (The direction is the 1pin of product is at the upper left when you hold reel on the left hand and you pull out the tape on the right hand) |

Reel
 1pin
 Direction of feed
 *Order quantity needs to be multiple of the minimum quantity.

Physical Dimension, Tape and Reel Information – continued

| | |
|--------------|---------|
| Package Name | SOP-J14 |
|--------------|---------|

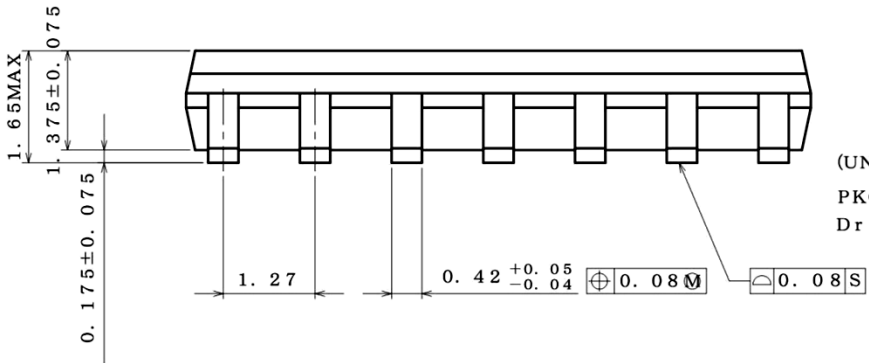
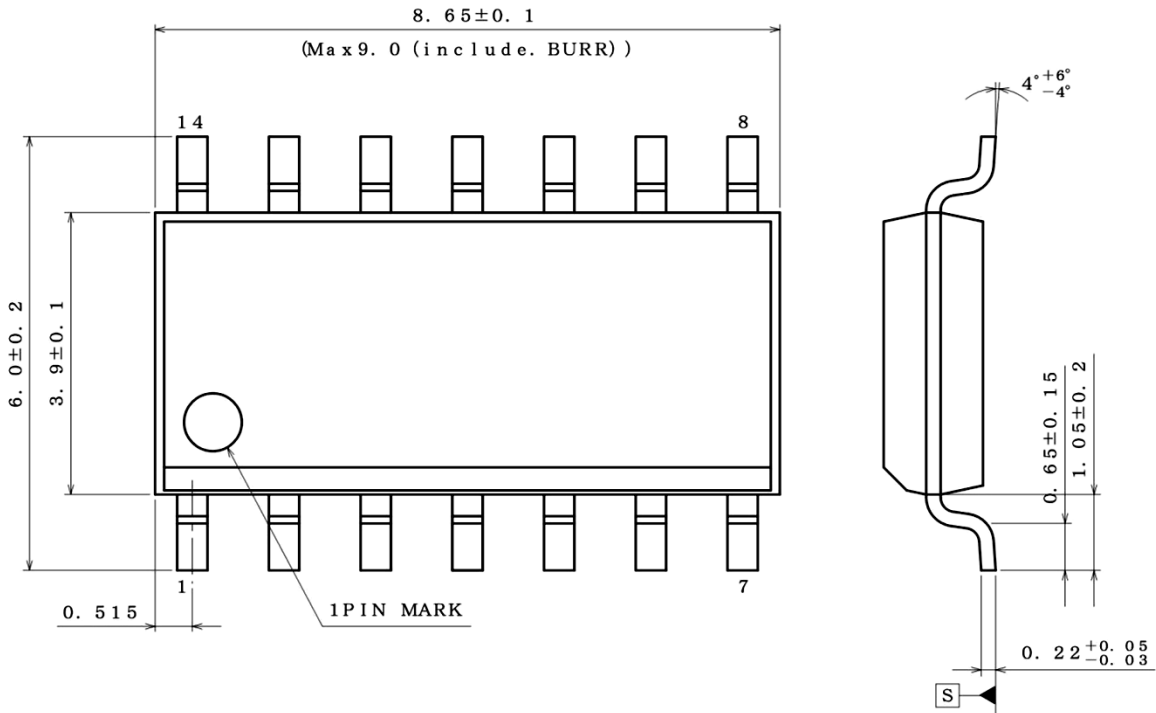

(UNIT : mm)
 PKG : SOP-J14
 Drawing No. EX126-5002-1

<Tape and Reel information>

| | |
|-------------------|---|
| Tape | Embossed carrier tape |
| Quantity | 2500pcs |
| Direction of feed | E2 (The direction is the 1pin of product is at the upper left when you hold reel on the left hand and you pull out the tape on the right hand) |

1pin
 *Order quantity needs to be multiple of the minimum quantity.

Physical Dimension, Tape and Reel Information – continued

| | |
|--------------|------------|
| Package Name | TSSOP-B14J |
|--------------|------------|

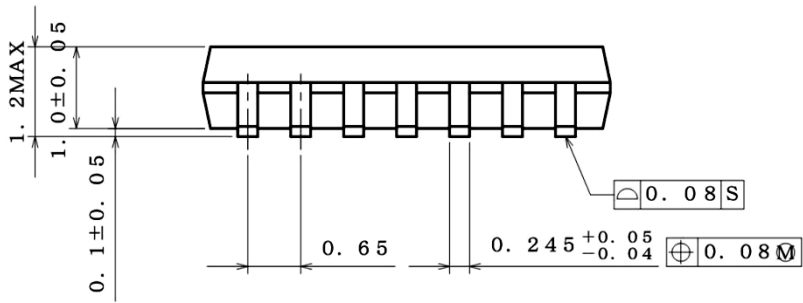
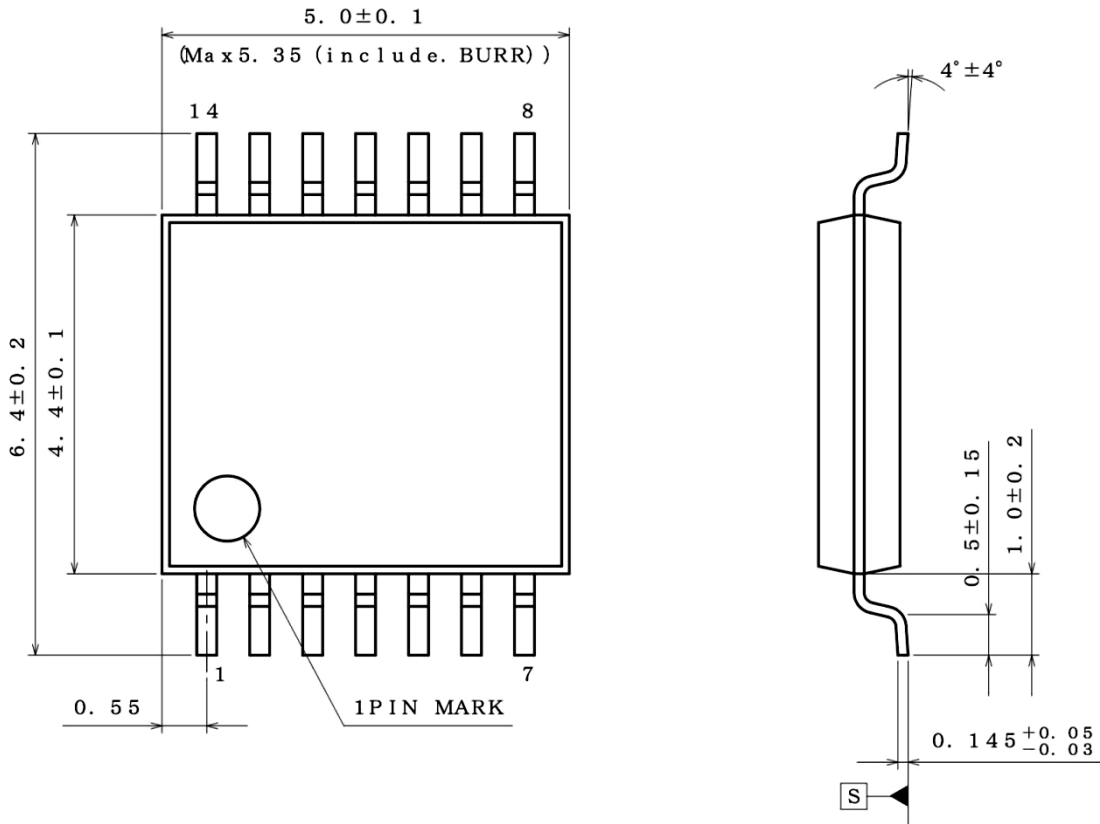

(UNIT : mm)
 PKG : TSSOP-B14J
 Drawing No. EX166-5002-1

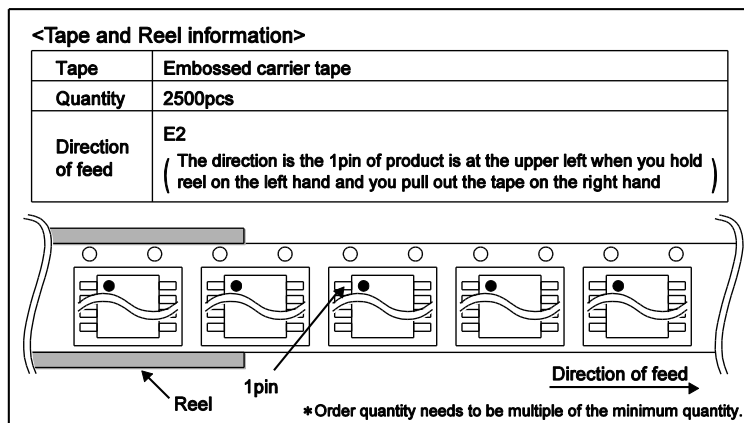

Marking Diagram

SSOP5(TOP VIEW)

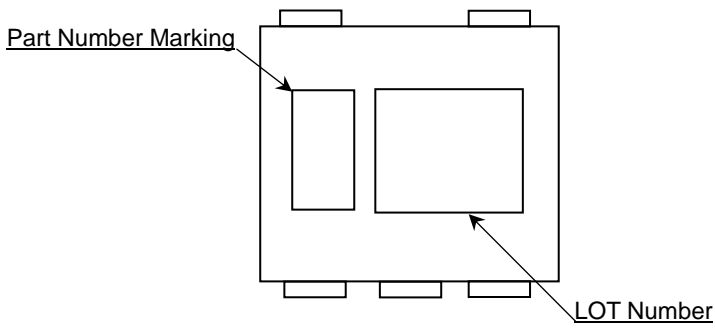

SOP8(TOP VIEW)

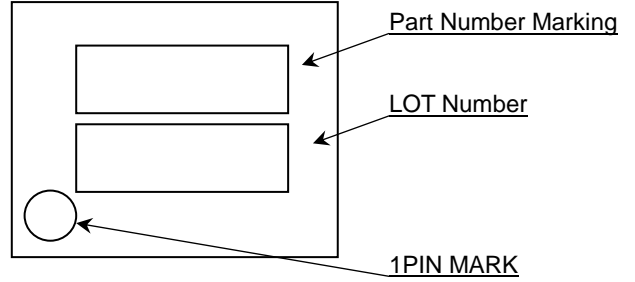

SOP-J8(TOP VIEW)

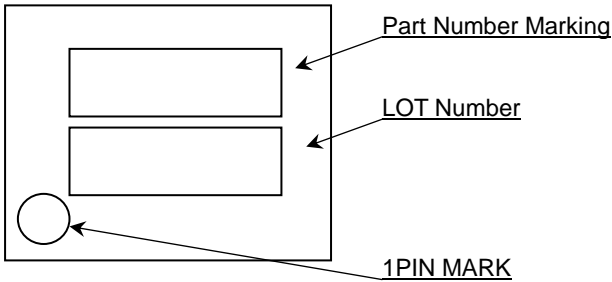

SSOP-B8(TOP VIEW)

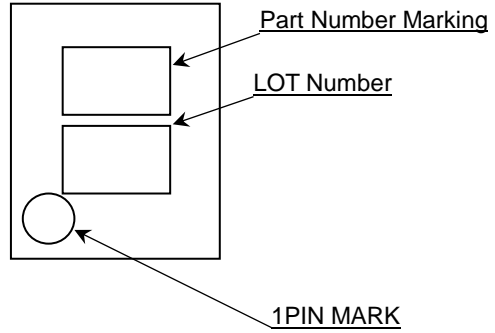

TSSOP-B8(TOP VIEW)

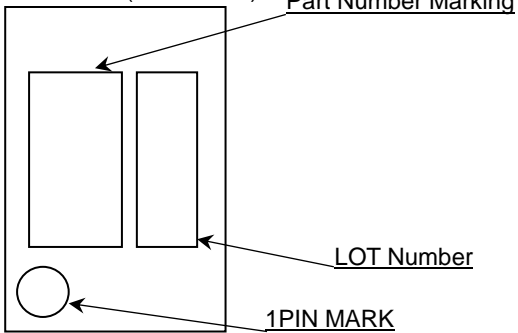

MSOP8(TOP VIEW)

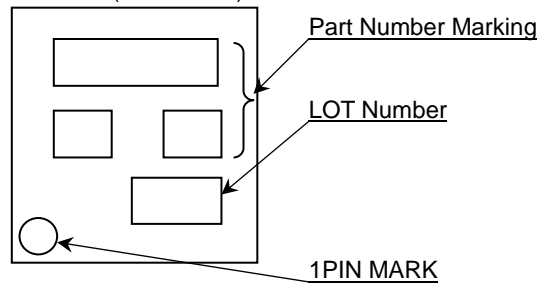

TSSOP-B8J(TOP VIEW)

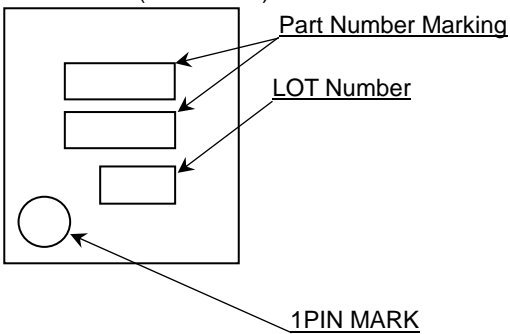

SOP14(TOP VIEW)

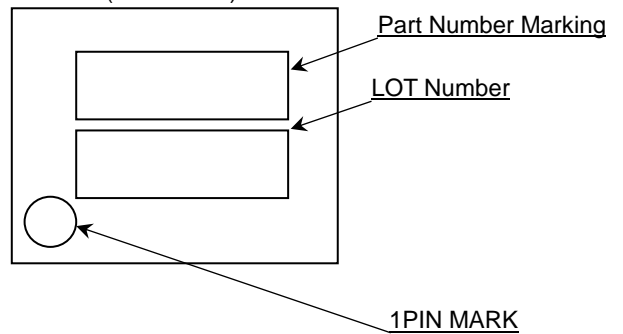

SOP-J14(TOP VIEW)

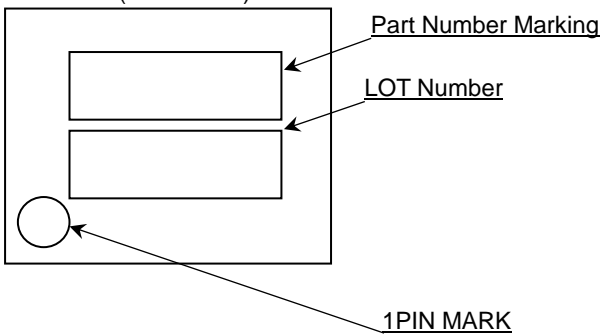

TSSOP-B14J (TOP VIEW)

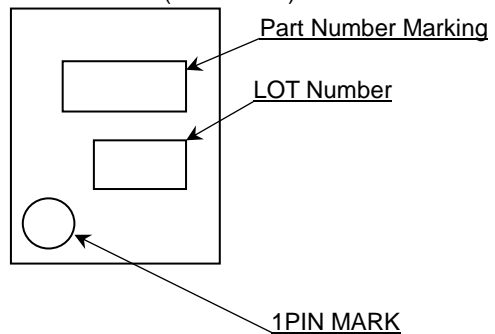

Marking Diagram - continued

| Product Name | | Package Type | Marking |
|--------------|-----|--------------|----------|
| LMR821 | G | SSOP5 | L3 |
| LMR822 | F | SOP8 | L822 |
| | FJ | SOP-J8 | R822 |
| | FV | SSOP-B8 | R822 |
| | FVT | TSSOP-B8 | R822 |
| | FVM | MSOP8 | R822 |
| | FVJ | TSSOP-B8J | R822 |
| LMR824 | F | SOP14 | LMR824F |
| | FJ | SOP-J14 | LMR824FJ |
| | FVJ | TSSOP-B14J | R824 |

Land Pattern Data

All dimensions in mm

| PKG | Land pitch e | Land space MIE | Land length ≥ l 2 | Land width b2 |
|-----------------------------------|-----------------|-------------------|----------------------|------------------|
| SSOP5 | 0.95 | 2.4 | 1.0 | 0.6 |
| SOP8 SOP14 | 1.27 | 4.60 | 1.10 | 0.76 |
| SOP-J8 SOP-J14 | 1.27 | 3.90 | 1.35 | 0.76 |
| SSOP-B8 TSSOP-B8 TSSOP-B14J | 0.65 | 4.60 | 1.20 | 0.35 |
| MSOP8 | 0.65 | 2.62 | 0.99 | 0.35 |
| TSSOP-B8J | 0.65 | 3.20 | 1.15 | 0.35 |

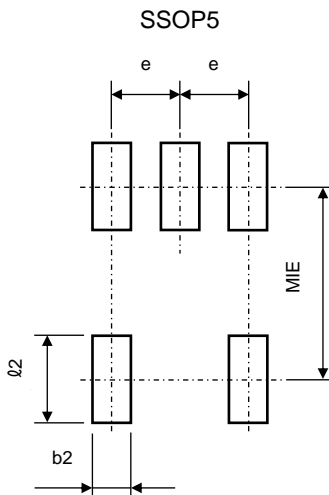

SOP8, SOP-J8, SSOP-B8, MSOP8, TSSOP-B8, TSSOP-B8J, SOP14, SOP-J14, TSSOP-B14J

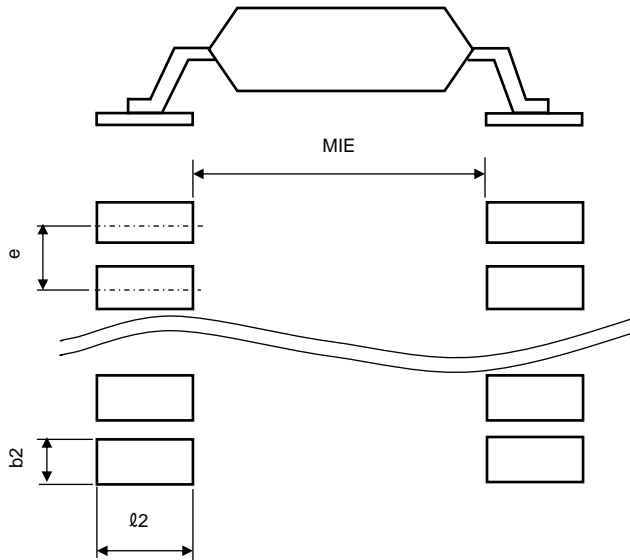

Revision History

| Date | Revision | Changes |
|-------------|----------|---|
| 18.Jan.2013 | 001 | New Release |
| 2.Aug.2013 | 002 | LMR822F is added. |
| 15.Oct.2013 | 003 | The Limit value change of LMR822F (MAX value change in Input Offset Voltage.) |
| 3.Dec.2013 | 004 | LMR822FJ, LMR822FV, LMR822FVT, LMR822FVM, and LMR822FVJ added |
| 10.Oct.2014 | 005 | LMR824F is added. |
| 11.May.2015 | 006 | LMR824FJ, and LMR824FVJ are added. |

Notice

Precaution on using ROHM Products

- Our Products are designed and manufactured for application in ordinary electronic equipments (such as AV equipment, OA equipment, telecommunication equipment, home electronic appliances, amusement equipment, etc.). If you intend to use our Products in devices requiring extremely high reliability (such as medical equipment ^(Note 1), transport equipment, traffic equipment, aircraft/spacecraft, nuclear power controllers, fuel controllers, car equipment including car accessories, safety devices, etc.) and whose malfunction or failure may cause loss of human life, bodily injury or serious damage to property ("Specific Applications"), please consult with the ROHM sales representative in advance. Unless otherwise agreed in writing by ROHM in advance, ROHM shall not be in any way responsible or liable for any damages, expenses or losses incurred by you or third parties arising from the use of any ROHM's Products for Specific Applications.

(Note1) Medical Equipment Classification of the Specific Applications

| JAPAN | USA | EU | CHINA |
|-----------|-----------|------------|-----------|
| CLASS III | CLASS III | CLASS II b | CLASS III |
| CLASS IV | | CLASS III | |

- ROHM designs and manufactures its Products subject to strict quality control system. However, semiconductor products can fail or malfunction at a certain rate. Please be sure to implement, at your own responsibilities, adequate safety measures including but not limited to fail-safe design against the physical injury, damage to any property, which a failure or malfunction of our Products may cause. The following are examples of safety measures:
 - Installation of protection circuits or other protective devices to improve system safety
 - Installation of redundant circuits to reduce the impact of single or multiple circuit failure
- Our Products are designed and manufactured for use under standard conditions and not under any special or extraordinary environments or conditions, as exemplified below. Accordingly, ROHM shall not be in any way responsible or liable for any damages, expenses or losses arising from the use of any ROHM's Products under any special or extraordinary environments or conditions. If you intend to use our Products under any special or extraordinary environments or conditions (as exemplified below), your independent verification and confirmation of product performance, reliability, etc. prior to use, must be necessary:
 - Use of our Products in any types of liquid, including water, oils, chemicals, and organic solvents
 - Use of our Products outdoors or in places where the Products are exposed to direct sunlight or dust
 - Use of our Products in places where the Products are exposed to sea wind or corrosive gases, including Cl₂, H₂S, NH₃, SO₂, and NO₂
 - Use of our Products in places where the Products are exposed to static electricity or electromagnetic waves
 - Use of our Products in proximity to heat-producing components, plastic cords, or other flammable items
 - Sealing or coating our Products with resin or other coating materials
 - Use of our Products without cleaning residue of flux (even if you use no-clean type fluxes, cleaning residue of flux is recommended); or Washing our Products by using water or water-soluble cleaning agents for cleaning residue after soldering
 - Use of the Products in places subject to dew condensation
- The Products are not subject to radiation-proof design.
- Please verify and confirm characteristics of the final or mounted products in using the Products.
- In particular, if a transient load (a large amount of load applied in a short period of time, such as pulse. is applied, confirmation of performance characteristics after on-board mounting is strongly recommended. Avoid applying power exceeding normal rated power; exceeding the power rating under steady-state loading condition may negatively affect product performance and reliability.
- De-rate Power Dissipation (Pd) depending on Ambient temperature (Ta). When used in sealed area, confirm the actual ambient temperature.
- Confirm that operation temperature is within the specified range described in the product specification.
- ROHM shall not be in any way responsible or liable for failure induced under deviant condition from what is defined in this document.

Precaution for Mounting / Circuit board design

- When a highly active halogenous (chlorine, bromine, etc.) flux is used, the residue of flux may negatively affect product performance and reliability.
- In principle, the reflow soldering method must be used on a surface-mount products, the flow soldering method must be used on a through hole mount products. If the flow soldering method is preferred on a surface-mount products, please consult with the ROHM representative in advance.

For details, please refer to ROHM Mounting specification

Precautions Regarding Application Examples and External Circuits

1. If change is made to the constant of an external circuit, please allow a sufficient margin considering variations of the characteristics of the Products and external components, including transient characteristics, as well as static characteristics.
2. You agree that application notes, reference designs, and associated data and information contained in this document are presented only as guidance for Products use. Therefore, in case you use such information, you are solely responsible for it and you must exercise your own independent verification and judgment in the use of such information contained in this document. ROHM shall not be in any way responsible or liable for any damages, expenses or losses incurred by you or third parties arising from the use of such information.

Precaution for Electrostatic

This Product is electrostatic sensitive product, which may be damaged due to electrostatic discharge. Please take proper caution in your manufacturing process and storage so that voltage exceeding the Products maximum rating will not be applied to Products. Please take special care under dry condition (e.g. Grounding of human body / equipment / solder iron, isolation from charged objects, setting of Ionizer, friction prevention and temperature / humidity control).

Precaution for Storage / Transportation

1. Product performance and soldered connections may deteriorate if the Products are stored in the places where:
 - [a] the Products are exposed to sea winds or corrosive gases, including Cl₂, H₂S, NH₃, SO₂, and NO₂
 - [b] the temperature or humidity exceeds those recommended by ROHM
 - [c] the Products are exposed to direct sunshine or condensation
 - [d] the Products are exposed to high Electrostatic
2. Even under ROHM recommended storage condition, solderability of products out of recommended storage time period may be degraded. It is strongly recommended to confirm solderability before using Products of which storage time is exceeding the recommended storage time period.
3. Store / transport cartons in the correct direction, which is indicated on a carton with a symbol. Otherwise bent leads may occur due to excessive stress applied when dropping of a carton.
4. Use Products within the specified time after opening a humidity barrier bag. Baking is required before using Products of which storage time is exceeding the recommended storage time period.

Precaution for Product Label

QR code printed on ROHM Products label is for ROHM's internal use only.

Precaution for Disposition

When disposing Products please dispose them properly using an authorized industry waste company.

Precaution for Foreign Exchange and Foreign Trade act

Since concerned goods might be fallen under listed items of export control prescribed by Foreign exchange and Foreign trade act, please consult with ROHM in case of export.

Precaution Regarding Intellectual Property Rights

1. All information and data including but not limited to application example contained in this document is for reference only. ROHM does not warrant that foregoing information or data will not infringe any intellectual property rights or any other rights of any third party regarding such information or data.
2. ROHM shall not have any obligations where the claims, actions or demands arising from the combination of the Products with other articles such as components, circuits, systems or external equipment (including software).
3. No license, expressly or implied, is granted hereby under any intellectual property rights or other rights of ROHM or any third parties with respect to the Products or the information contained in this document. Provided, however, that ROHM will not assert its intellectual property rights or other rights against you or your customers to the extent necessary to manufacture or sell products containing the Products, subject to the terms and conditions herein.

Other Precaution

1. This document may not be reprinted or reproduced, in whole or in part, without prior written consent of ROHM.
2. The Products may not be disassembled, converted, modified, reproduced or otherwise changed without prior written consent of ROHM.
3. In no event shall you use in any way whatsoever the Products and the related technical information contained in the Products or this document for any military purposes, including but not limited to, the development of mass-destruction weapons.
4. The proper names of companies or products described in this document are trademarks or registered trademarks of ROHM, its affiliated companies or third parties.

General Precaution

1. Before you use our Products, you are requested to carefully read this document and fully understand its contents. ROHM shall not be in any way responsible or liable for failure, malfunction or accident arising from the use of any ROHM's Products against warning, caution or note contained in this document.
2. All information contained in this document is current as of the issuing date and subject to change without any prior notice. Before purchasing or using ROHM's Products, please confirm the latest information with a ROHM sales representative.
3. The information contained in this document is provided on an "as is" basis and ROHM does not warrant that all information contained in this document is accurate and/or error-free. ROHM shall not be in any way responsible or liable for any damages, expenses or losses incurred by you or third parties resulting from inaccuracy or errors of or concerning such information.