



TO :

DATE : July. 29. 2009

SMD TFT-LCD

MODEL NO. : LMS430HF18

Customer Approval

Any Modification of Spec is not allowed without SMD's permission.

Approved by : Se chun, Oh

Samsung Mobile Display Co.



EVERYWHERE
WITH YOUR EYES



Revision History

Date	Rev. No.	Page	Summary
Feb. 6.2009	000		Rev.000 was first issues.
	001	6	Storage Temperature was changed from -30~70 to -40~85℃
		24	Module outline was revised. (Bare FPC was changed from ver0.5 to ver0.6)
			29 Reliability Test Result was added

Contents

General Description	-----	(4)
1. Absolute Maximum Ratings	-----	(6)
1.1 Absolute Ratings Of Environment		
1.2 Electrical Absolute Ratings		
2. Optical Characteristics	-----	(8)
3. Electrical Characteristics	-----	(12)
3.1 TFT-LCD Module		
3.2 Back-light Unit		
4. Block Diagram	-----	(14)
4.1 TFT-LCD Module(Interface System Structure) with Back Light Unit		
4.2 Back-light Unit		
5. Input Terminal Pin Assignment	-----	(15)
5.1 Input Signal & Power		
5.2 Input Signal, Basic Display colors and Gray Scale of Each Colors		
5.3 Pixel Format		
6. Interface Timing	-----	(18)
7. Power On/Off Sequence	-----	(23)
8. Outline Dimension	-----	(24)
9. Packing	-----	(25)
10. Marking & Others	-----	(26)
11. General Precaution	-----	(27)
11.1 Handling		
11.2 Storage		
11.3 Operation		
11.4 Others		
12. Reliability Test Condition	-----	(29)

General Description

* Description

LMS430HF18 is a TMR(Transmissive with Micro Reflective) type color active matrix TFT (Thin Film Transistor) liquid crystal display (LCD) that uses amorphous silicon TFT as a switching devices. This model is composed of a TFT-LCD module, a driver circuit and a back-light unit.

The resolution of a 4.3" contains 480x272xRGB dots and can display up to 16.7M colors.

* Features

- Transmissive with Micro Reflective type and back-light with 10 LEDs are available.
- Visible in outdoor & back-light off condition with reflectivity.
- VA(Normally black) mode.
- 24bit RGB Interface
- DE(Data Enable) & SYNC mode - DE, Vsync, Hsync, DOTCLK

* Applications

- Display terminals for PMP(Portable Multimedia Player) , Potable CNS(P-CNS) application products.
- Display terminals for AV application products

*** General information**

Items	Specification	Unit	Note
Display area	95.04(H) x 53.856(V) (4.3" diagonal)	mm	-
Driver element	a-Si TFT active matrix	-	-
Display colors	16,777,216	colors	-
Number of pixels	480 x 272 x RGB	dot	-
Pixel arrangement	RGB stripe	-	-
Pixel pitch	0.198(H) x 0.198(V)	mm	128ppi
Display mode	Normally black	-	-

*** Mechanical information**

Item		Min.	Typ.	Max.	Unit	Note
Module size	Horizontal(H)	105.3	105.5	105.7	mm	-
	Vertical(V)	67.0	67.2	67.4	mm	(1)
	Depth(D)	2.7	2.9	3.1	mm	(1)
Weight		-	45	-	g	(2)

Note (1) Not include FPC.

Refer to the Outline Dimension in the "8. Outline Dimension" for further information.

(2)Back-light unit are included.

1. Absolute Maximum Ratings

1.1 Absolute Ratings Of Environment

ITEM	MIN	MAX	REMARK
Storage Temperature	-40℃	85℃	Note(1)
Operating Temperature	-20℃	60℃	Note(2)(3)

Note(1) 90%RH maximum humidity, 60℃ maximum wet-bulb temperature

- (2) When operated at a temperature lower than 0℃, the LCD worked slowly and the screen appeared low-contrast images due to the characteristics of LC(Liquid Crystal).
- (3) If any fixed pattern is displayed on LCD for minutes, image-sticking phenomenon may occur.

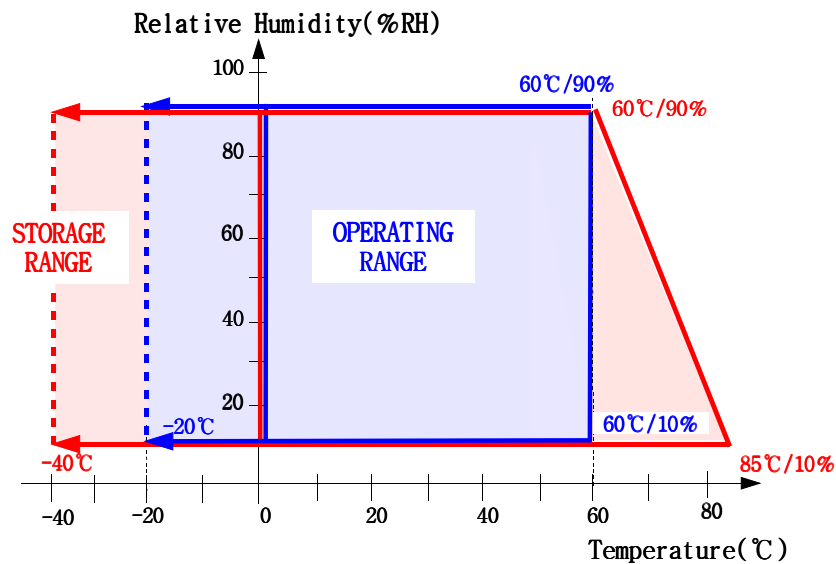

Temperature & Humidity Graph at Absolute Environment



1.2 Electrical Absolute Ratings

(1) TFT-LCD Module

(Ta = 25 ± 2°C, VSS=GND=0)

Item	Symbol	Min.	Max.	Unit	Note
Digital power supply	VDD	-0.3	4.6	V	-

(2) Back-Light Unit

(Ta = 25 ± 2°C)

Item	Symbol	Min.	Max.	Unit.	Note
Current	I _B	-	25	mA	(1)

Note (1) Permanent damage to the device may occur if maximum values are exceeded or reverse voltage is loaded.

Functional operation should be restricted to the conditions described under normal operating conditions.

2. Optical Characteristics

The following items are measured under stable conditions. The optical characteristics should be measured in a dark room or equivalent state with the methods shown in Note (1).

Measuring equipment : SR-3, BM-7, EZ-Contrast

(Ta = 25 ± 2°C, VDD=2.5V or 3.3V, fv= 60Hz, fDCLK=9.2MHz, IL = 22mA)

Item		Symbol	Condition	Min.	Typ.	Max.	Unit	Note
Contrast ratio (Center point)		C/R	NOTE (1)	400	800	-	-	(2) SR-3
Luminance of white (Center point)		Y _L		225	300	-	cd/m ²	(3) SR-3
Color Gamut (Center point)		-		45	50	-	%	
Brightness Uniformity (9 point)		B _{uni}		70	80	-	-	
Response time	Rising	T _R	Normal Viewing Angle	-	17	22	msec	(4) BM-7
	Falling	T _F		-	15	20		
Color chromaticity (CIE 1931)	White	W _X	B/L On	0.27	0.32	0.37	-	(5) SR-3
		W _Y		0.29	0.34	0.39		
	Red	R _X		0.55	0.60	0.65		
		R _Y		0.31	0.36	0.41		
	Green	G _X		0.32	0.37	0.42		
		G _Y		0.52	0.57	0.62		
Blue	B _X	0.10	0.15	0.20				
	B _Y	0.07	0.12	0.17				
Viewing angle	Hor.	Θ _L	C/R ≥ 10 B/L On	70	80	-	Degrees	(6) Ez-Contrast
		Θ _R		70	80	-		
	Ver.	Φ _H		70	80	-		
		Φ _L		70	80	-		

Note (1) Test Equipment Setup

After stabilizing and leaving the panel alone at a given temperature for 30 min , the measurement should be executed. Measurement should be executed in a stable, windless, and dark room. 30 min after lighting the back-light. This should be measured in the center of screen.

Environment condition : $T_a = 25 \pm 2 \text{ }^\circ\text{C}$

Back-Light On condition

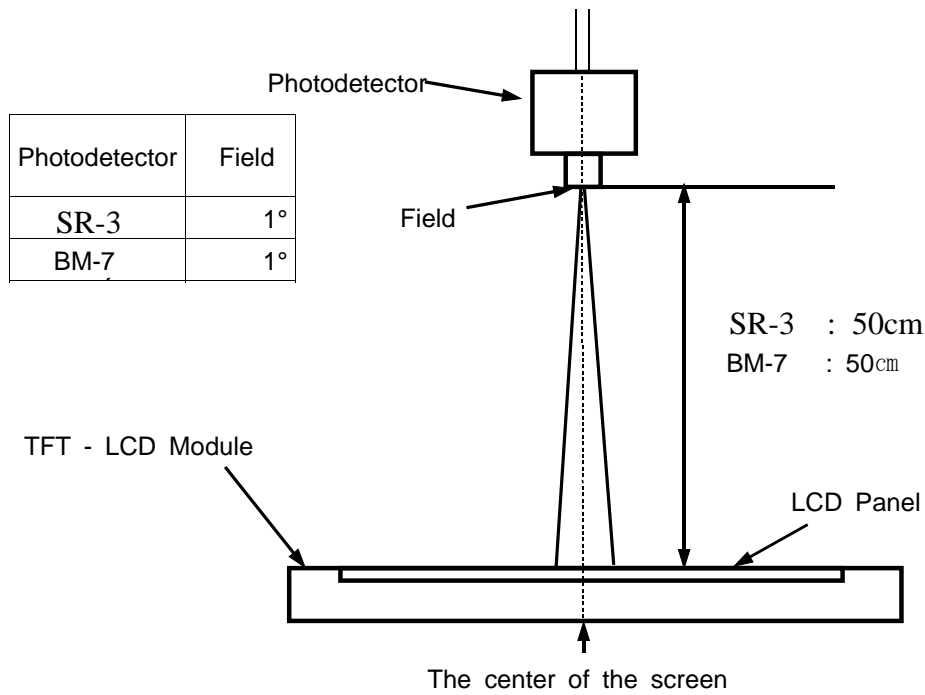

Note (2) Definition of Contrast Ratio (C/R) : Ratio of gray max (Gmax) & gray min (Gmin) at the center point

$$CR = \frac{G \text{ max}}{G \text{ min}}$$

* Gmax : Luminance with all pixels white

* Gmin : Luminance with all pixels black

Note (3) Definition of Luminance of White (Y_L) : Luminance of white at the center point

Definition of Brightness Uniformity (B_{uni})

$$B_{uni} = \left(\frac{B \text{ min}}{B \text{ max}} \right) \times 100$$

where, Bmax = Maximum Brightness

Bmin = Minimum Brightness

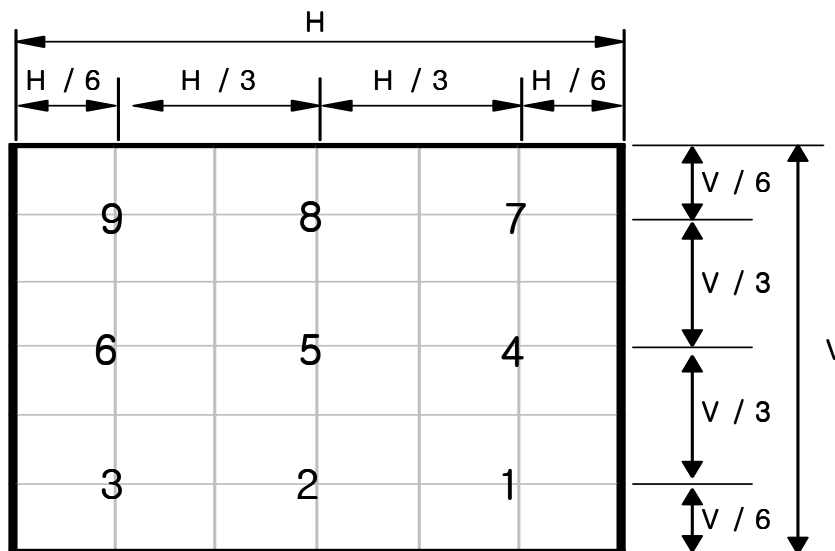

The spot locations for luminance measurement

Note (4) Definition of Response time : Sum of Tr ,Tf

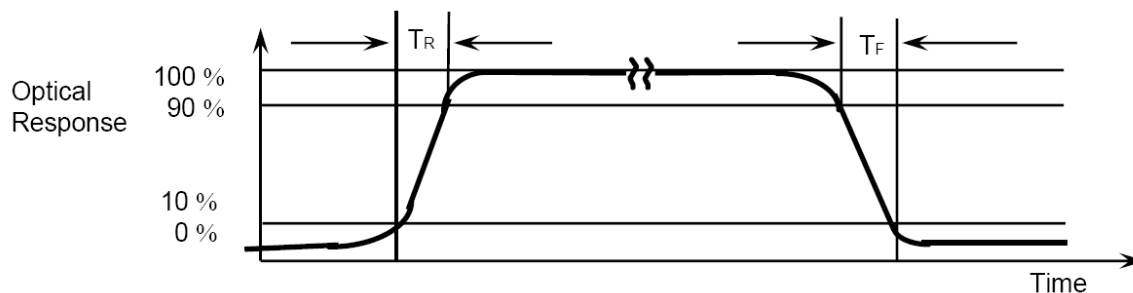
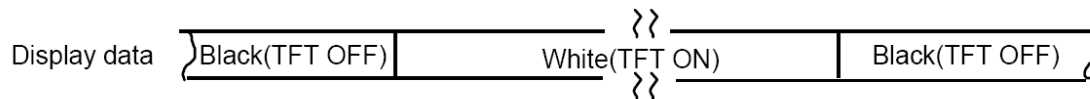

Note (5) Definition of Color Chromaticity (CIE 1931)

Color coordinate of white & red, green, blue at center point.

Note (6) Definition of Viewing Angle : Viewing angle range ($CR \geq 10$)

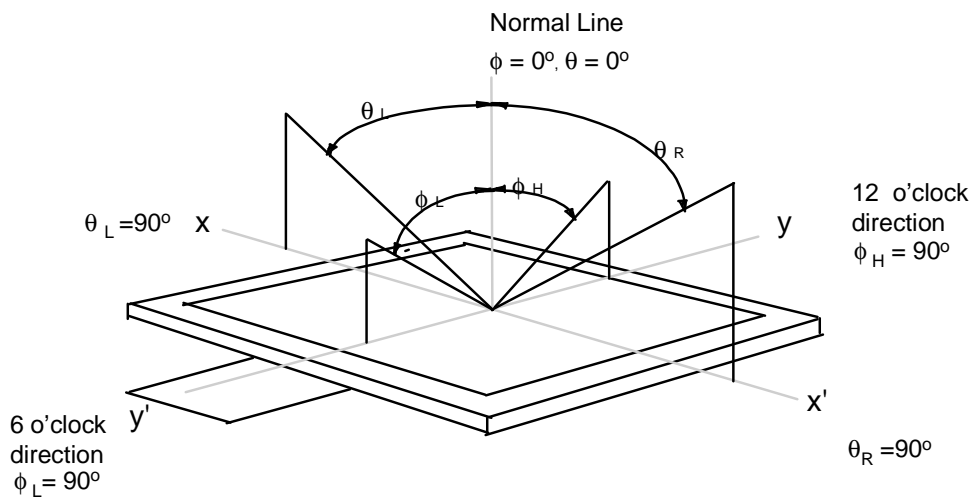

3. Electrical Characteristics

3.1 TFT-LCD Module

 $T_a = 25 \pm 2^\circ\text{C}$

ITEM		Symbol	Min.	Typ.	Max.	Unit	Note
Digital power supply		VDD	2.25	2.5	2.9	V	(1)
			2.9	3.3	3.5	V	(2)
Input "High" level voltage		V _{IH}	0.7*VDD	-	VDD	V	
Input "Low" level voltage		V _{IL}	0	-	0.3*VDD	V	
Vsync Frequency		f _v	-	60	70	Hz	
Hsync Frequency		f _H	-	17.28	-	kHz	
Main Frequency		f _{DCLK}	-	9.2	15.0	MHZ	
Power Dissipation	White	-	-	(100)	120	mW	(3), (4)
	Black		-	(85)	105	mW	

Note (1). PWRSEL = Low

Note (2). PWRSEL = High

※ Refer to the "6. Input Terminal Pin Assignment"

Note (3). f_v=60Hz, f_{DCLK}=9.2MHZ, VDD=2.5V or 3.3V

Note (4). Power Dissipation check pattern

a) White Pattern

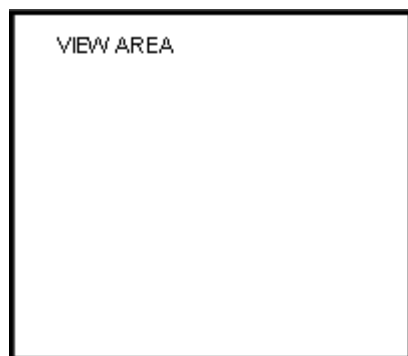

b) Black Pattern

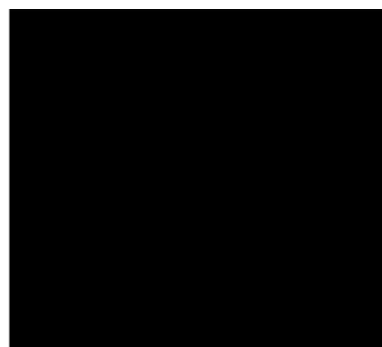

3.2 Back-Light unit

The back-light system is an edge-lighting type with 10 white LED(Light Emitting Diode)s.

($T_a=25 \pm 2^\circ\text{C}$)

Item	Symbol	Min.	Typ.	Max.	Unit	Note
LEDs Current	I_B	-	22	24	mA	(1)(3)
Power Consumption	P_{BL}	-	730	-	mW	(2)(3)

Note (1) 10 LEDs serial type.

(2) Where $I_B = 22 \text{ mA}$, $V_B = P_{BL} / I_B$

(3) DC current(voltage) use only.

If PWM(pulse width modulation) used, some problems may be happened.

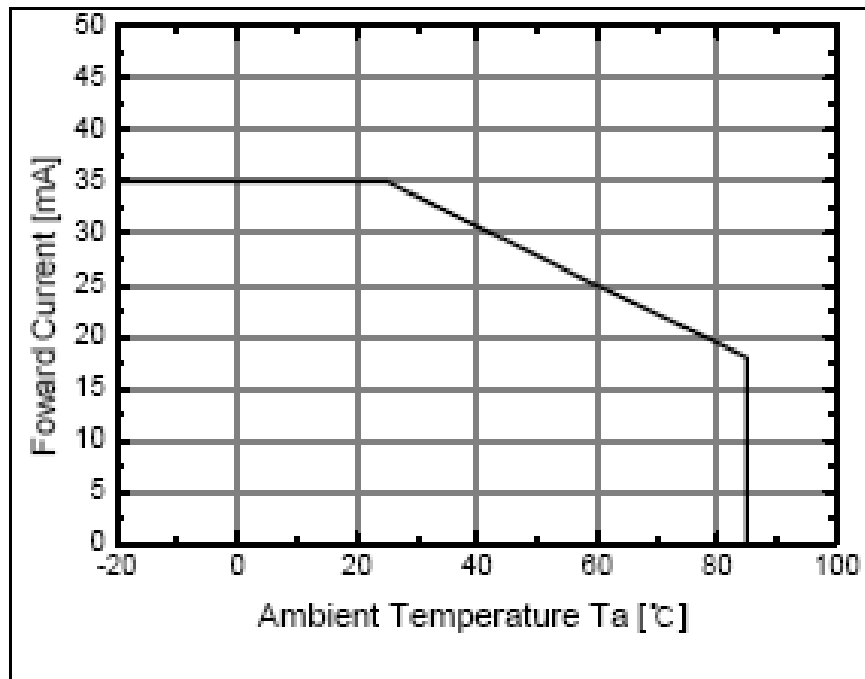

4. Block Diagram

4.1 TFT-LCD Module (Interface System Structure) with Back Light Unit

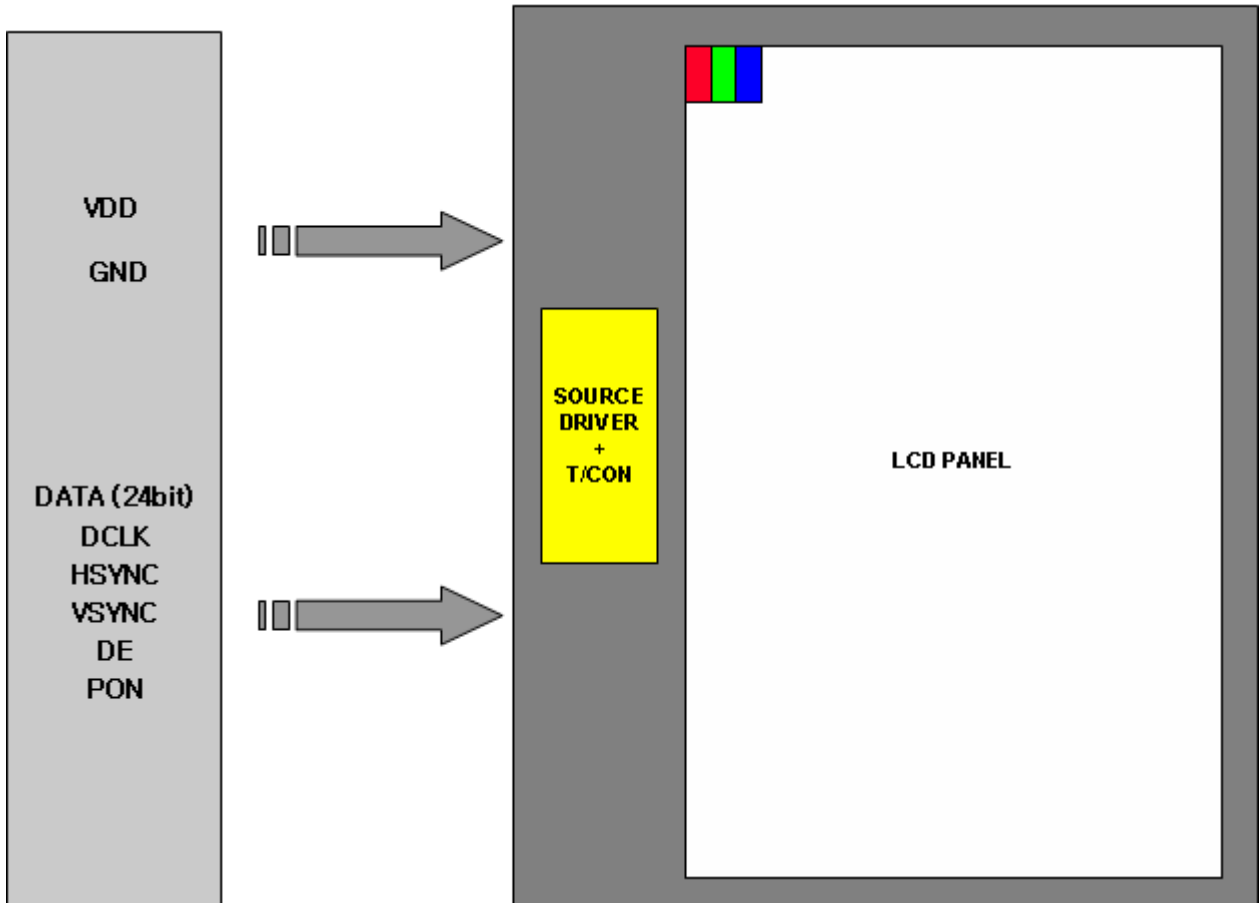

4.2 Back-light Unit (Connector : 2 pin FPC Solder type)

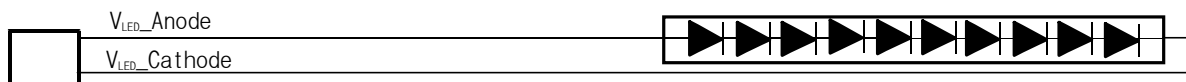

5. Input Terminal Pin Assignment

5.1 Input Signal & Power (Connector type : 45Pin / 0.5mm pitch / Top contact)

- Hirose : FH12 series

Pin#	Symbol	Function	Remark	Pin#	Symbol	Function	Remark
1	VSS	Ground		26	B5	Blue Data	
2	VSS	Ground		27	B6	Blue Data	
3	VDD	Power Supply (2.5or3.3V)		28	B7	Blue Data	(MSB)
4	VDD	Power Supply (2.5or3.3V)		29	VSS	Ground	
5	R0	Red Data	(LSB)	30	PCLK	Pixel Clock	
6	R1	Red Data		31	PON	Display on/off	
7	R2	Red Data		32	HSYNC	Horizontal Sync Signal	
8	R3	Red Data		33	VSYNC	Vertical Sync Signal	
9	R4	Red Data		34	DE	Data Enable	
10	R5	Red Data		35	PWRSEL	VDD power select	High:3.3V Low:2.5V
11	R6	Red Data		36	VSS	Ground	
12	R7	Red Data	(MSB)	37	NC	Non Connect	
13	G0	Green Data	(LSB)	38	NC	Non Connect	
14	G1	Green Data		39	NC	Non Connect	
15	G2	Green Data		40	NC	Non Connect	
16	G3	Green Data		41	VSS	Ground	
17	G4	Green Data		42	VLED1-	LED 1 Cathode	
18	G5	Green Data		43	VLED1+	LED 1 Anode	
19	G6	Green Data		44	NC	Non Connect	
20	G7	Green Data	(MSB)	45	NC	Non Connect	
21	B0	Blue Data	(LSB)				
22	B1	Blue Data					
23	B2	Blue Data					
24	B3	Blue Data					
25	B4	Blue Data					

5.2 Input Signal, Basic Display Colors and Gray Scale of Each Colors

COLOR	DISPLAY	DATA SIGNAL																								GRAY SCALE LEVEL
		RED								GREEN								BLUE								
		R0	R1	R2	R3	R4	R5	R6	R7	G0	G1	G2	G3	G4	G5	G6	G7	B0	B1	B2	B3	B4	B5	B6	B7	
BASIC COLOR	BLACK	0	0	0	0	0	0	0	0	0	0	0	0	0	0	0	0	0	0	0	0	0	0	0	0	-
	BLUE	0	0	0	0	0	0	0	0	0	0	0	0	0	0	0	0	1	1	1	1	1	1	1	1	-
	GREEN	0	0	0	0	0	0	0	0	1	1	1	1	1	1	1	1	0	0	0	0	0	0	0	0	-
	CYAN	0	0	0	0	0	0	0	0	1	1	1	1	1	1	1	1	1	1	1	1	1	1	1	1	-
	RED	1	1	1	1	1	1	1	1	0	0	0	0	0	0	0	0	0	0	0	0	0	0	0	0	-
	MAGENTA	1	1	1	1	1	1	1	1	0	0	0	0	0	0	0	0	1	1	1	1	1	1	1	1	-
	YELLOW	1	1	1	1	1	1	1	1	1	1	1	1	1	1	1	1	0	0	0	0	0	0	0	0	-
	WHITE	1	1	1	1	1	1	1	1	1	1	1	1	1	1	1	1	1	1	1	1	1	1	1	1	-
GRAY SCALE OF RED	BLACK	0	0	0	0	0	0	0	0	0	0	0	0	0	0	0	0	0	0	0	0	0	0	0	R0	
	DARK ↑	1	0	0	0	0	0	0	0	0	0	0	0	0	0	0	0	0	0	0	0	0	0	0	R1	
		0	1	0	0	0	0	0	0	0	0	0	0	0	0	0	0	0	0	0	0	0	0	0	R2	
		:	:	:	:	:	:	:	:	:	:	:	:	:	:	:	:	:	:	:	:	:	:	:	:	R3~R252
		:	:	:	:	:	:	:	:	:	:	:	:	:	:	:	:	:	:	:	:	:	:	:	:	
	LIGHT ↓	1	0	1	1	1	1	1	1	0	0	0	0	0	0	0	0	0	0	0	0	0	0	0	R253	
		0	1	1	1	1	1	1	1	0	0	0	0	0	0	0	0	0	0	0	0	0	0	0	R254	
	RED	1	1	1	1	1	1	1	1	0	0	0	0	0	0	0	0	0	0	0	0	0	0	0	R255	
GRAY SCALE OF GREEN	BLACK	0	0	0	0	0	0	0	0	0	0	0	0	0	0	0	0	0	0	0	0	0	0	0	G0	
	DARK ↑	0	0	0	0	0	0	0	0	1	0	0	0	0	0	0	0	0	0	0	0	0	0	0	G1	
		0	0	0	0	0	0	0	0	0	1	0	0	0	0	0	0	0	0	0	0	0	0	0	G2	
		:	:	:	:	:	:	:	:	:	:	:	:	:	:	:	:	:	:	:	:	:	:	:	G3~G252	
		:	:	:	:	:	:	:	:	:	:	:	:	:	:	:	:	:	:	:	:	:	:	:		
	LIGHT ↓	0	0	0	0	0	0	0	0	1	0	1	1	1	1	1	1	0	0	0	0	0	0	0	G253	
		0	0	0	0	0	0	0	0	0	1	1	1	1	1	1	1	0	0	0	0	0	0	0	G254	
	GREEN	0	0	0	0	0	0	0	0	1	1	1	1	1	1	1	1	0	0	0	0	0	0	0	G255	
GRAY SCALE OF BLUE	BLACK	0	0	0	0	0	0	0	0	0	0	0	0	0	0	0	0	0	0	0	0	0	0	0	B0	
	DARK ↑	0	0	0	0	0	0	0	0	0	0	0	0	0	0	0	0	1	0	0	0	0	0	0	B1	
		0	0	0	0	0	0	0	0	0	0	0	0	0	0	0	0	1	0	0	0	0	0	0	B2	
		:	:	:	:	:	:	:	:	:	:	:	:	:	:	:	:	:	:	:	:	:	:	:	B3~B252	
		:	:	:	:	:	:	:	:	:	:	:	:	:	:	:	:	:	:	:	:	:	:	:		
	LIGHT ↓	0	0	0	0	0	0	0	0	0	0	0	0	0	0	0	0	1	0	1	1	1	1	1	B253	
		0	0	0	0	0	0	0	0	0	0	0	0	0	0	0	0	1	1	1	1	1	1	1	B254	
	BLUE	0	0	0	0	0	0	0	0	0	0	0	0	0	0	0	0	1	1	1	1	1	1	1	B255	

Note) Definition of Gray :

Rn : Red Gray, Gn : Green Gray, Bn : Blue Gray (n = Gray level)

Input Signal : 0 = Low level voltage, 1 = High level voltage

5.3 PIXEL FORMAT

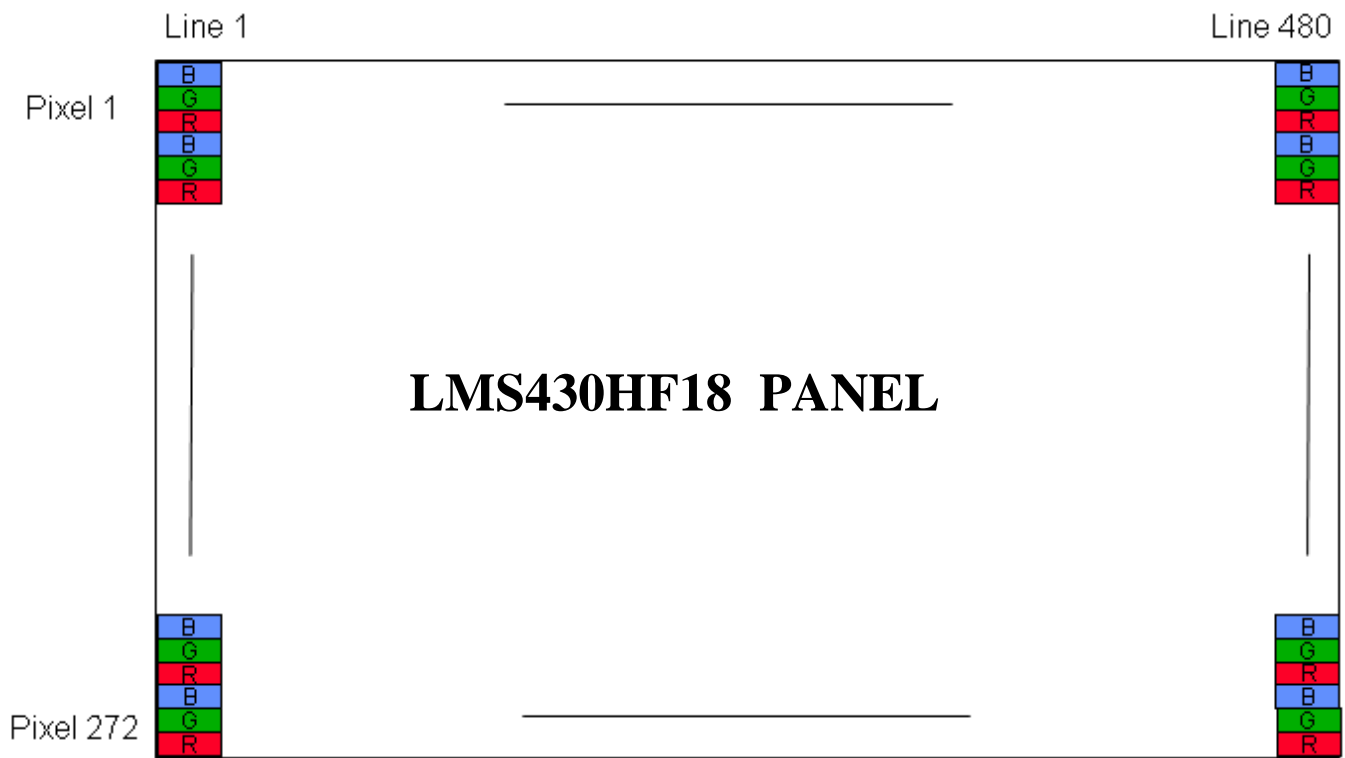

6. INTERFACE TIMING

6-1. Vertical timing

Signal	Symbol	Min.	Typ.	Max.	Unit	Note
Frame Frequency	fFRM	60	60	70	Hz	
VSYNC(Frame) Period	VCYC	286	288	335	H	Min: VDP + VBP + VFP (Min)
VSYNC Low width	VLW	1	10	-	H	
Vertical Display Period	VDP	-	272	-	H	
Vertical Back porch	VBP	-	12	-	H	
Vertical Front porch	VFP	2	4	-	H	

6-2. Horizontal timing

Signal	Symbol	Min.	Typ.	Max.	Unit	Note
HSYNC(1H) Period	HCYC	508	533	605	DOTCLK	
HSYNC Low width	HLW	4	41	80	DOTCLK	
Horizontal Display Period	HDP	-	480	-	DOTCLK	
Horizontal Back porch	HBP	26	45	-	DOTCLK	
Horizontal Front porch	HFP	2	8	-	DOTCLK	
DOTCLK Frequence	f _{DOTCLK}	-	9.2 @fFRM=60Hz	15	MHz	VDD=2.9~3.5V

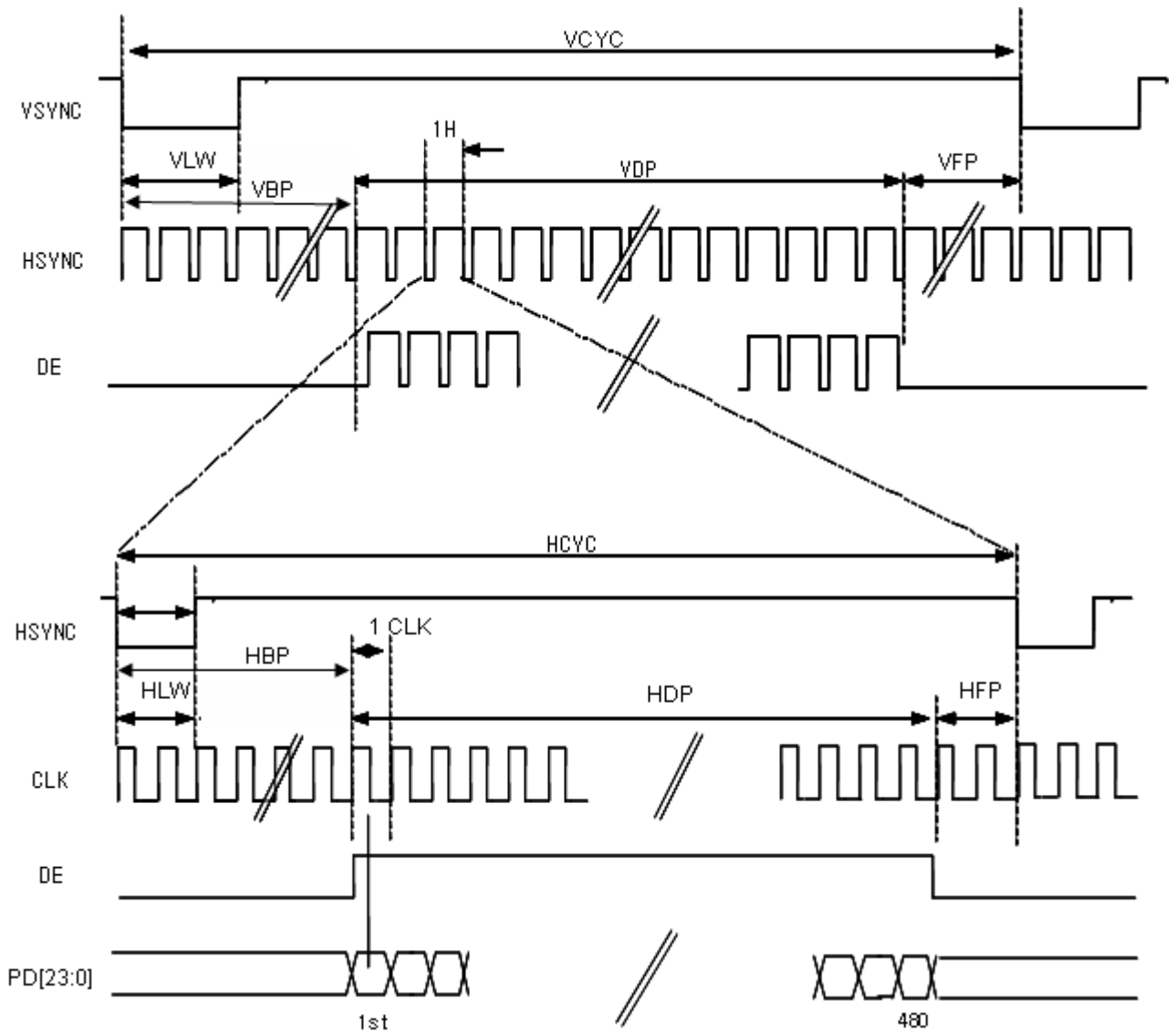

6-3. AC characteristics

* Operating at VDD=2.25~2.9V , Ta = -40°C~+85°C

Parameter	Symbol	Min.	Typ.	Max.	Unit
VSYNC,HSYNC setup time	t _{SYNCS}	10	-	-	ns
ENABLE (DE) setup time	t _{ENS}	10	-	-	
ENABLE (DE) hold time	t _{ENH}	10	-	-	
DOTCLK "Low" level pulse width	P _{WDL}	25	-	-	
DOTCLK "High" level pulse width	P _{WDH}	25	-	-	
DOTCLK cycle time	t _{CYCD}	66.7	-	-	
Data setup time	t _{PDS}	10	-	-	
Data hold time	t _{PDH}	10	-	-	
DOTCLK,VSYNC,HSYNC clock rise/fall time	t _{rgbr} t _{rgbf}	-	-	5	

* Operating at VDD=2.9~3.5V , Ta = -40°C~+85°C

Parameter	Symbol	Min.	Typ.	Max.	Unit
VSYNC,HSYNC setup time	t _{SYNCS}	10	-	-	ns
ENABLE (DE) setup time	t _{ENS}	10	-	-	
ENABLE (DE) hold time	t _{ENH}	10	-	-	
DOTCLK "Low" level pulse width	P _{WDL}	25	-	-	
DOTCLK "High" level pulse width	P _{WDH}	25	-	-	
DOTCLK cycle time	t _{CYCD}	66.7	-	-	
Data setup time	t _{PDS}	10	-	-	
Data hold time	t _{PDH}	10	-	-	
DOTCLK,VSYNC,HSYNC clock rise/fall time	t _{rgbr} t _{rgbf}	-	-	5	

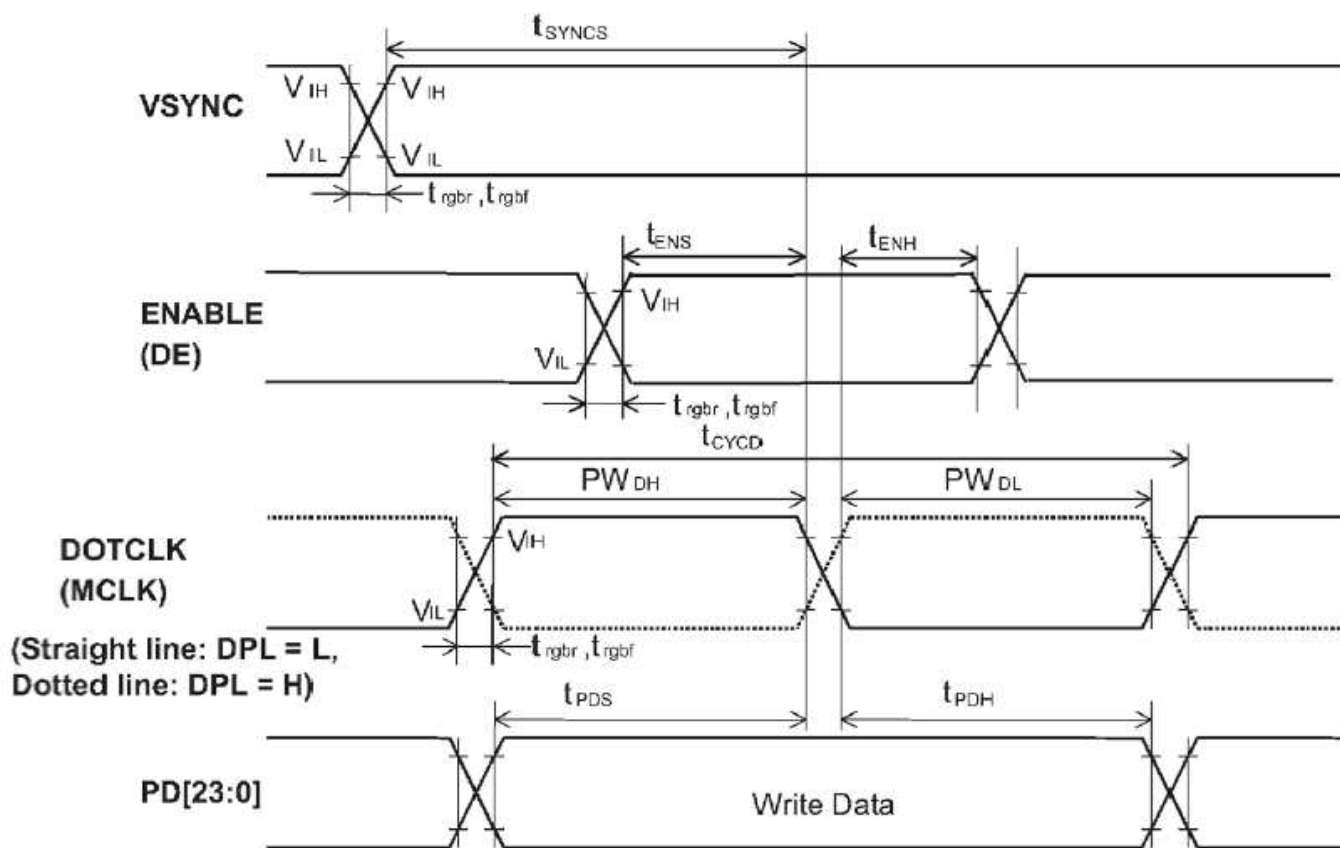

6-4. PON timing characteristics.

※ Operating at VDD=2.25~3.5V , Ta = -40°C~+85°C

Item	Symbol	Min.	Typ.	Max.	unit
PON setup (SYNC mode)	$t_{PONS\ V}$	10	-	-	DOTCLK

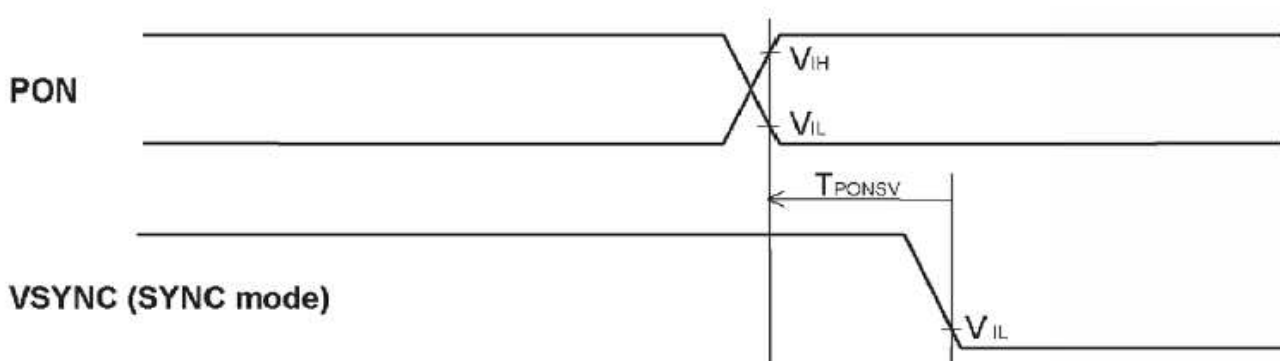

7. Power On/Off Sequence

- To prevent a latch-up or DC operation of the LCD module, the power on/off sequence should be as the diagram below.

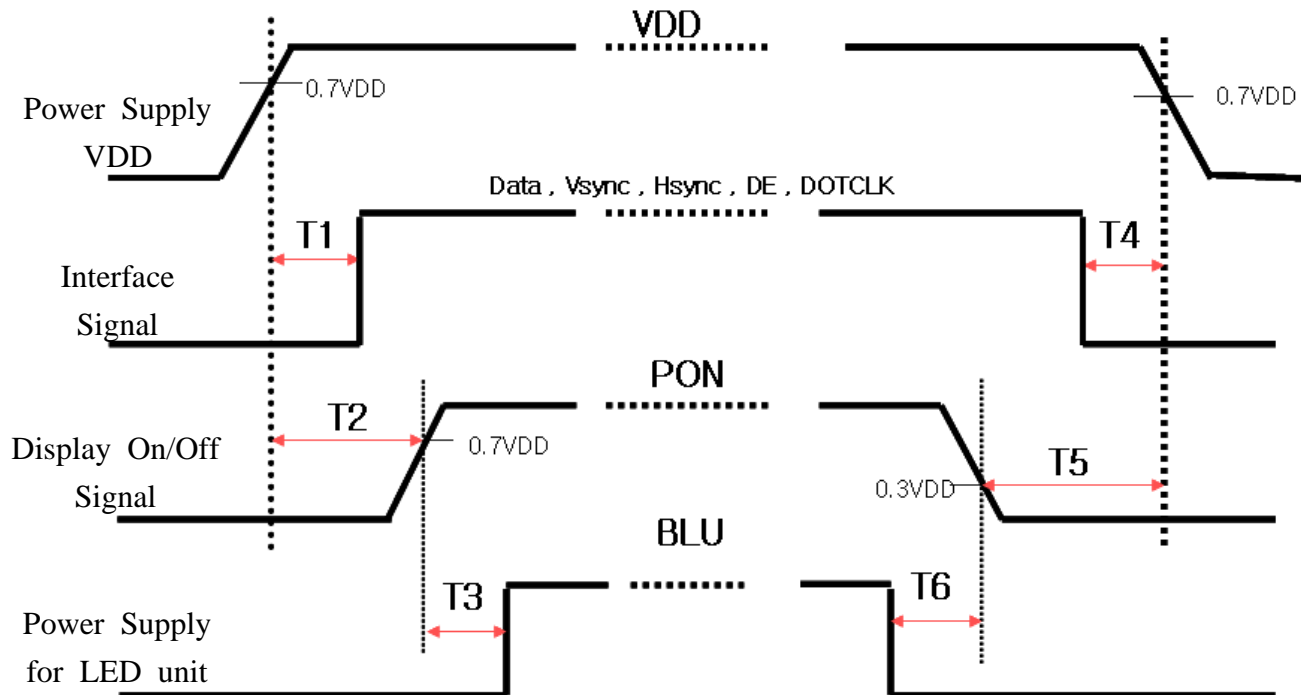

Symbol	Specification	Note
T1	$0 \text{ ms} < T1 < T2$	
T2	$10 \text{ ms} < T2$	(1)
T3	$10 \text{ frames} < T3$	
T4	$10 \text{ ms} < T4 < T5$	
T5	$(6 \text{ frames} + T4) < T5$	(1)
T6	$10 \text{ frames} < T6$	

Note(1) Refer to "6-4. PON timing characteristics."

8. Outline Dimension

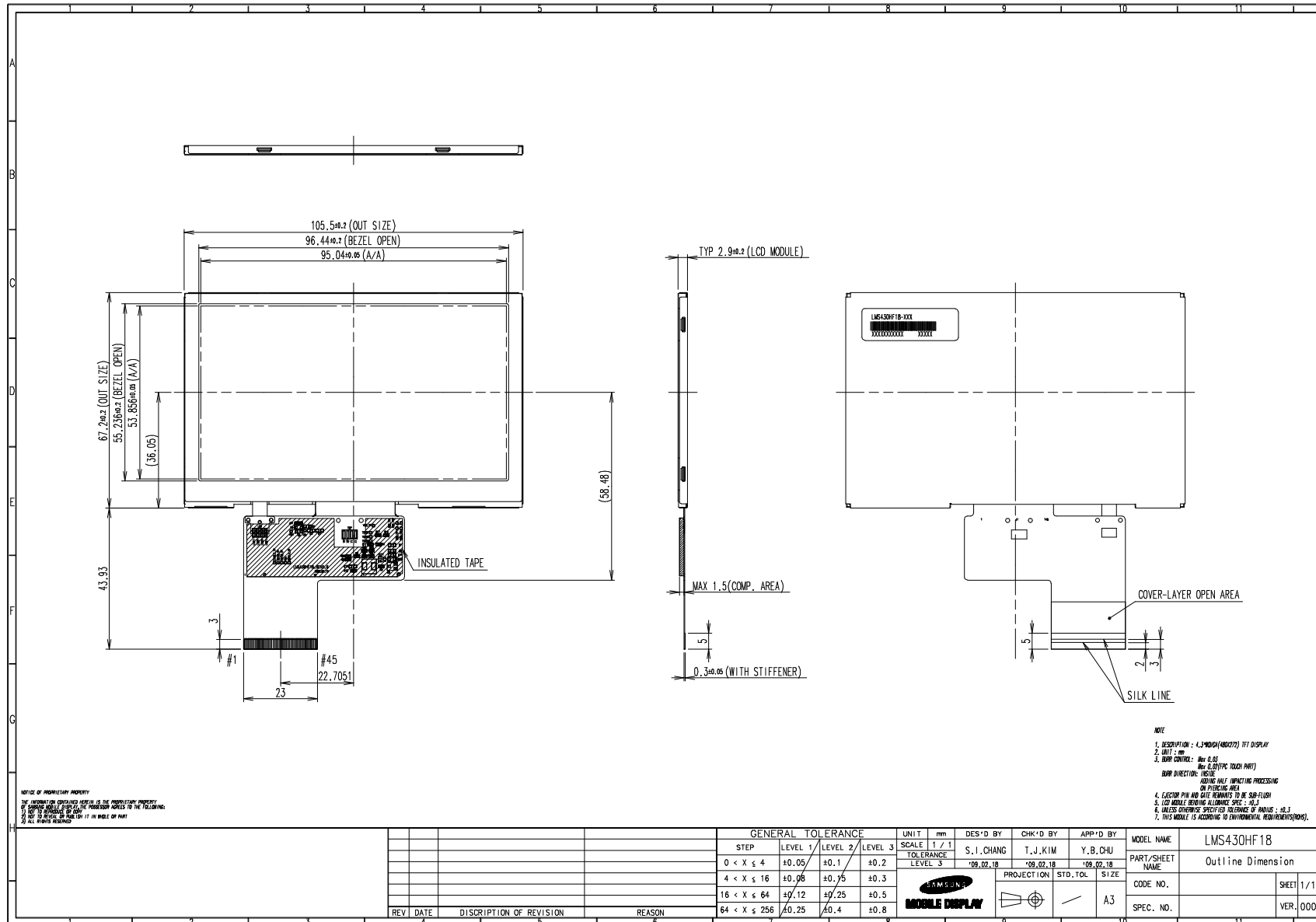

9. Packing

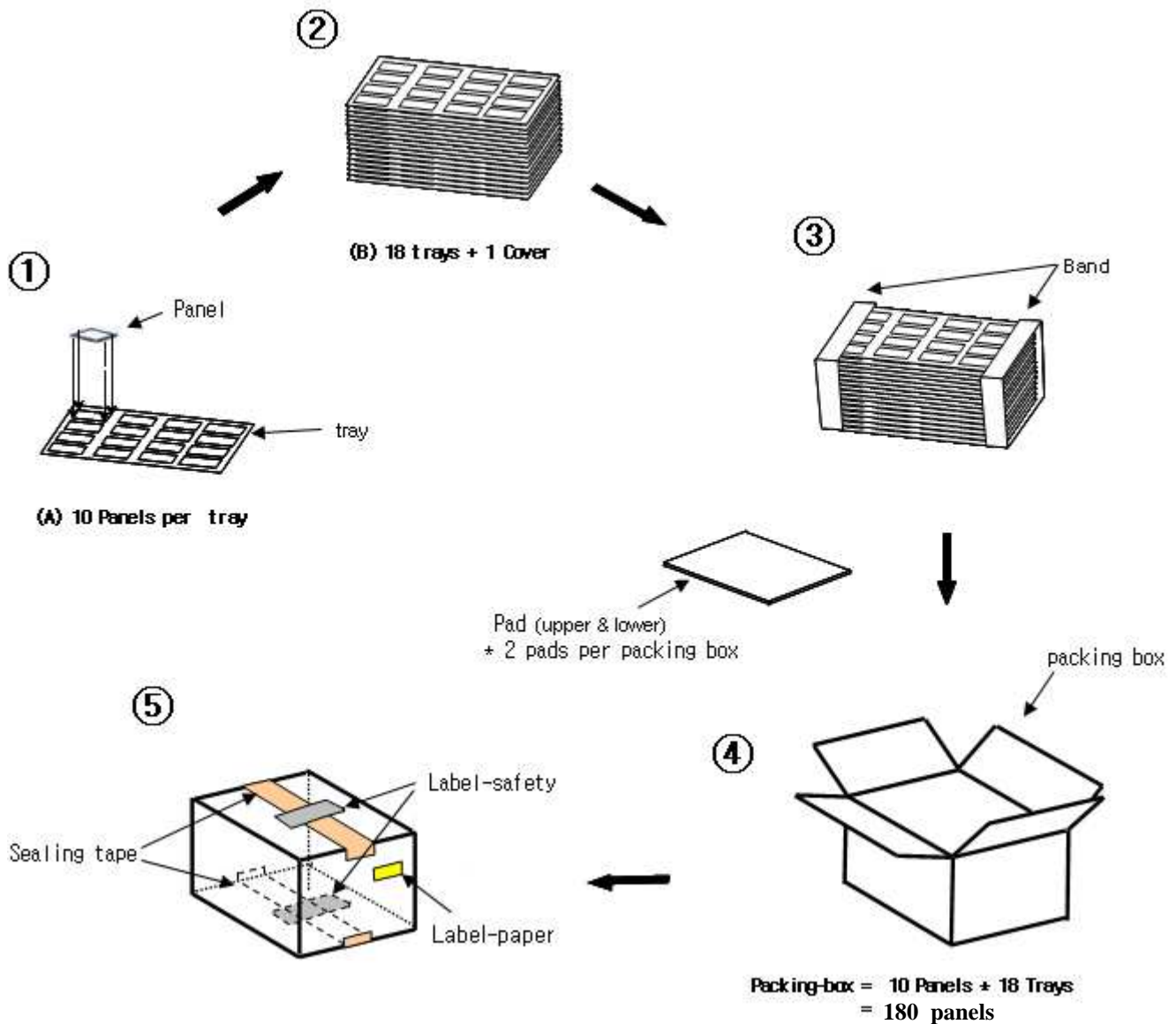

Note

- (1) Total : Box: Approx. : 13.7 Kg
- (2) Size : Box: 505(W) x 355(D) x 200(H)
- (3) Place the panels in the tray facing the direction shown in the figure.
- (4) Place 18 tray and cover(empty tray) and pads inside the packing-box.
- (5) Seal the packing-box. Affix the label-safety.

10. Marking & Others

A nameplate bearing followed by is affixed to a shipped product at the Specified location on each product.

(1) Packing case attach

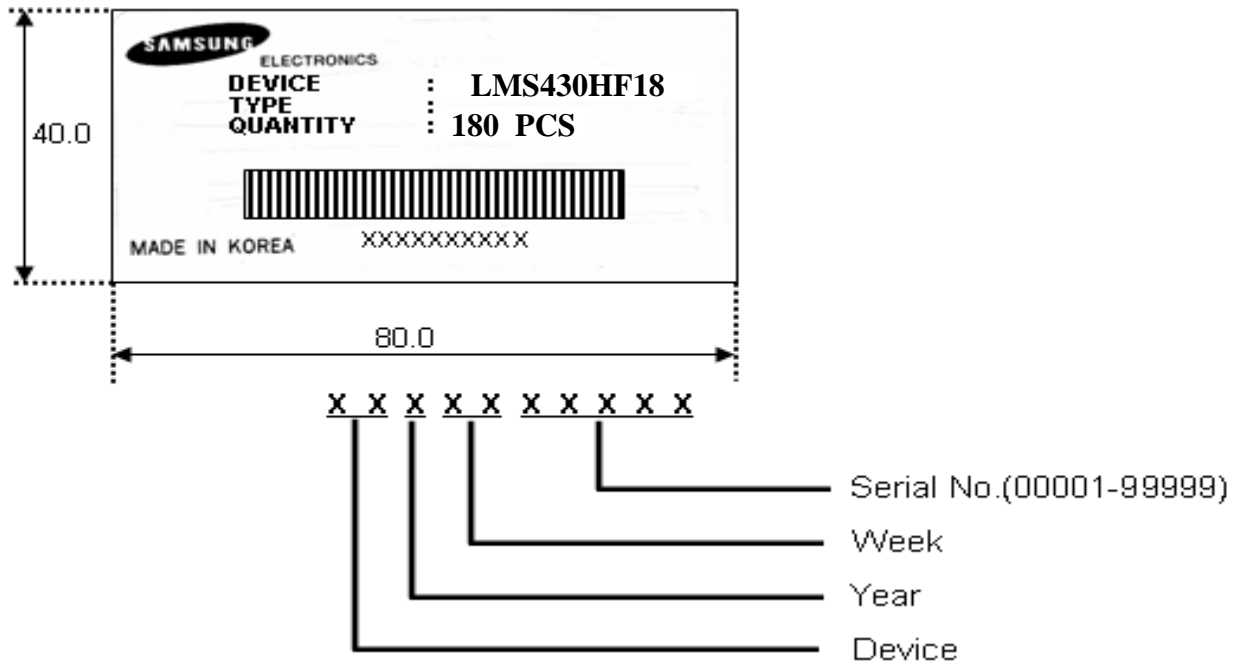

11. General Precautions

11.1 Handling

- (a) When the module is assembled, it should be attached to the system firmly. Be careful not to twist and bend the module.
- (b) Refrain from strong mechanical shock and / or any force to the module. In addition to damage, this may cause improper operation or damage to the module and back-light unit.
- (c) Note that polarizers are very fragile and could be easily damaged. Do not press or scratch the surface harder than a HB pencil lead.
- (d) Wipe off water droplets or oil immediately. If you leave the droplets for a long time, Staining and discoloration may occur.
- (e) If the surface of the polarizer is dirty, clean it using some absorbent cotton or soft cloth.
- (f) The desirable cleaners are water, IPA(Isopropyl Alcohol) or Hexane. Do not use Ketone type materials(ex. Acetone), Ethyl alcohol, Toluene, Ethyl acid or Methyl chloride. It might permanent damage to the polarizer due to chemical reaction.
- (g) If the liquid crystal material leaks from the panel, it should be kept away from the eyes or mouth. In case of contact with hands, legs or clothes, it must be washed away thoroughly with soap.
- (h) Protect the module from static , it may cause damage to the Integrated Gate Circuit.
- (i) Use finger-stalls with soft gloves in order to keep display clean during the incoming inspection and assembly process.
- (j) Do not disassemble the module.
- (k) Do not adjust the variable resistor which is located on the back side.
- (l) Protection film for polarizer on the module shall be slowly peeled off just before use so that the electrostatic charge can be minimized.
- (m) Pins of I/F connector shall not be touched directly with bare hands

11.2 Storage

- (a) Do not leave the panel in high temperature, and high humidity for a long time. It is highly recommended to store the module with temperature from 0 to 35°C and relative humidity of less than 70%.
- (b) Do not store the TFT-LCD module in direct sunlight.
- (c) The module shall be stored in a dark place. It is prohibited to apply sunlight or fluorescent light during the store.

11.3 Operation

- (a) Do not connect, disconnect the module in the "Power On" condition.
- (b) Power supply should always be turned on/off by the "Power on/off sequence"
- (c) Module has high frequency circuits. Sufficient suppression to the electromagnetic interference shall be done by system manufacturers. Grounding and shielding methods may be important to minimize the interference.

11.4 Others

- (a) The Liquid crystal is deteriorated by ultraviolet, do not leave it in direct sunlight and strong ultraviolet ray for many hours.
- (b) Avoid condensation of water. It may result in improper operation or disconnection of electrode.
- (c) Do not exceed the absolute maximum rating value. (the supply voltage variation, input voltage variation, variation in part contents and environmental temperature, and so on) Otherwise the panel may be damaged.
- (d) If the panel displays the same pattern continuously for a long period of time, it can be the situation when the image "Sticks" to the screen.
- (e) This panel has its circuitry FPC on the bottom side and should be handled carefully in order not to be stressed.
- (f) Avoid shortness between LED soldering pad and TSP soldering pad.

12. Reliability Test Condition

Item	Condition	Sample Size	Test Result	Remark
High Temperature Operating Life test	60℃ 160HR	10EA	PASS	Note(5)
Low Temperature Operating Life test	- 20℃ 160HR	5EA	PASS	
Thermal Humidity Bias	60℃ 90%RH 160HR	10EA	PASS	Note(5)
On/Off Test	70℃ ⇔ - 30℃ (5CYC),	10EA	PASS	Note(1)
High Temperature Storage test	85℃ 160HR	5EA	PASS	
Low Temperature Storage test	- 40℃ 160HR	5EA	PASS	
Wet Humidity Temperature Storage test	60℃/90%RH 160HR	10EA	PASS	
Altitude test	Non-operating:188mb/Room Temp. 72HR	5EA	PASS	
Thermal Cycle storage test	- 40 ~ 85℃, 30CYC	10EA	PASS	Note(2)
Electrical Static Discharge	Contact:±4kV, 150pF/330Ω Non-contact:±8kV, 150pF/330Ω	5EA 5EA	PASS	Note(3)
Box Vibration	Random Vibration MIN-STD 810E, up/down(Z)Axis	(1BOX Small)	PASS	Note(4)
Box Drop	1 corner, 3 edges, 6 surfaces under 9.1kg:76cm, 9.2~18.2kg: 66cm	(1BOX Medium)	PASS	

Note(1) ON Time over 10 seconds, OFF Time under 10 seconds.

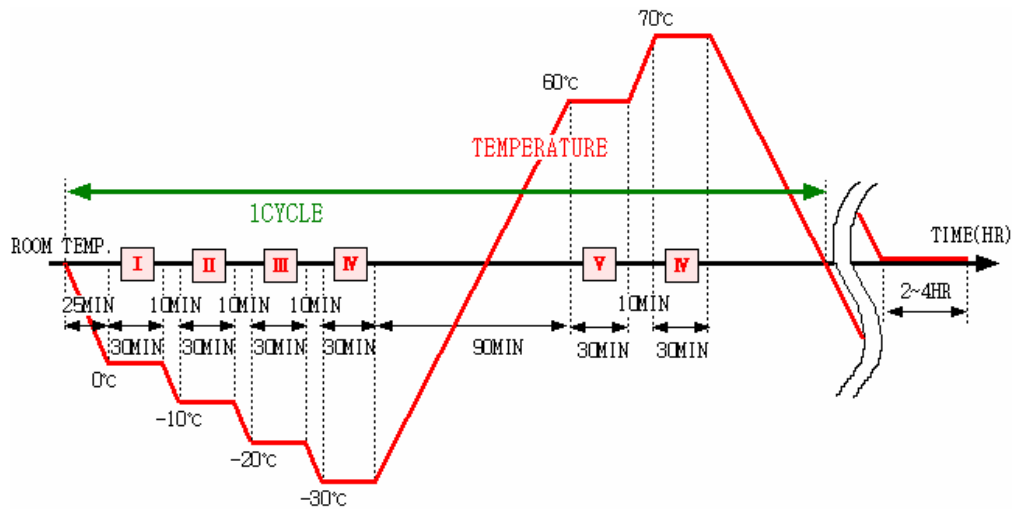

Note(2) STORAGE

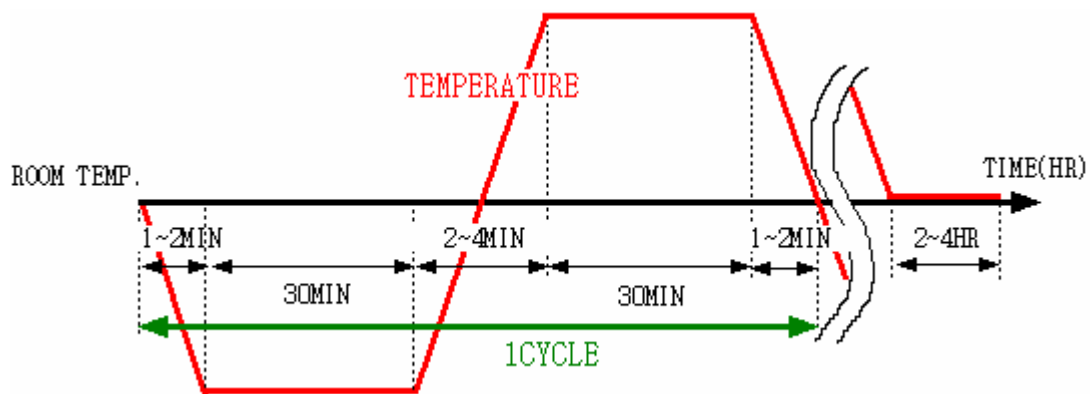

Note(3) Main-LCD, 5 times to every 4 corners of active area.

Note(4) Basic transportation by common carrier environmental, 514.4 MIL-STD-810E.

OVERALL RMS LEVEL	BREAK POINT					
	FREQUENCY	PSD VALUE	FREQUENCY	PSD VALUE	FREQUENCY	PSD VALUE
0.74G	10Hz	0.00650	121Hz	0.00300	340Hz	0.00003
	20Hz	0.00650	200Hz	0.00300	500Hz	0.00015
	120Hz	0.00020	240Hz	0.00150	-	-

Note(5) After finishing Reliability Test and leaving samples in room temperature condition during 2hours, malfunction and abnormal should not be found.