



深圳市拓普微科技开发有限公司

SHENZHEN TOPWAY TECHNOLOGY CO., LTD.

LMT070DICFWD-3

LCD Module User Manual

Prepared by: Zou Guo Rui Date: 2015-07-16	Checked by: Date:	Approved by: Date:
--	----------------------------------	-----------------------------------

Rev.	Descriptions	Release Date
0.1	Preliminary release	2015-02-09
0.2	Update Section 5.0	2015-07-16

Table of Content

1. Applications	3
2. General Specification	3
3. Block Diagram.....	4
4. Terminal Function.....	5
4.1 K1 TFT Input Terminal	5
5. Absolute Maximum Ratings.....	6
6. Electrical Characteristics	6
6.1 DC Characteristics	6
6.2 Current Consumption	6
6.3 LED Backlight Circuit Characteristics	6
6.4 Power Sequence.....	7
7. AC Characteristics	8
7.1 Timing Characteristics.....	8
7.2 Input Clock and Data Timing Diagram.....	8
7.3 Timing	9
7.4 Data Input Format	10
7.5 Optical Characteristics	11
8. Precautions of using LCD Modules	12

1. Applications

This Module is designed for portable DVD, GPS car TV & PMP(portable multimedia player) application which require high quality flat panel displays. It is also a good substitute for many outmoded CSTN module in the industrial application.

This product is composed of a TFT-LCD panel, driver ICs, FPC ,LED backlight unit .

2. General Specification

Signal Interface :	Digital 24-bits RGB
Display Technology :	a-Si TFT active matrix
Display Mode :	TN Type Full Color / Transmissive / Normal White
Screen Size(Diagonal) :	7.0"
Outline Dimension :	164.9 x 100.0 x 5.7 (mm) (see attached drawing for details)
Active Area :	154.08 x 85.92 (mm)
Number of dots :	800 x 3 (RGB) x 480
Pixel Pitch :	0.1926 x 0.179 (mm)
Pixel Configuration :	RGB Stripe
Backlight :	LED
Viewing Direction :	6 o'clock(Gray scale Inversion) (*1) 12 o'clock (*2)
Operating Temperature :	-20 ~ +60°C
Storage Temperature :	-30 ~ +80°C
Surface Treatment :	Anti-Glare Treatment

Note:

*1. For saturated color display content (eg. pure-red, pure-green, pure-blue or pure-colors-combinations).

*2. For "color scales" display content.

*3. Color tone may slightly change by temperature and driving condition.

3. Block Diagram

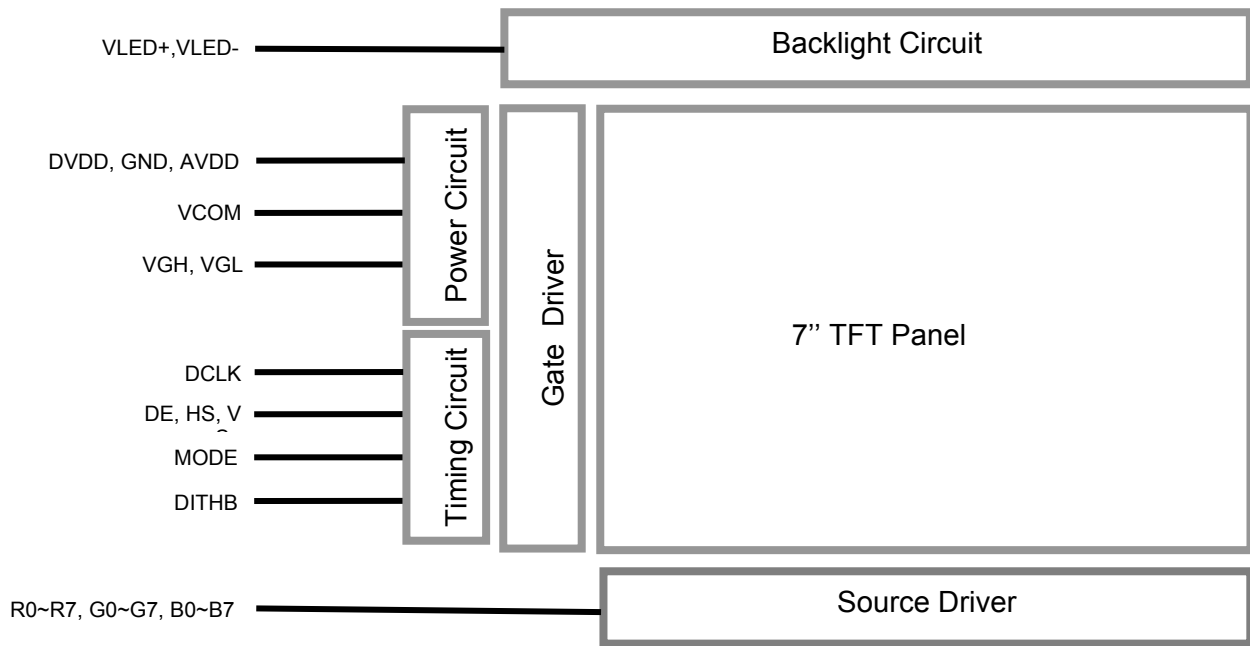

4. Terminal Function

4.1 K1 TFT Input Terminal

Pin No.	Pin Name	I/O	Descriptions
1	V _{LED+}	Power	Positive Backlight Power Supply
2	V _{LED+}		
3	V _{LED-}	Power	Negative Backlight Power Supply
4	V _{LED-}		
5	GND	Power	Power GND (0V)
6	V _{COM}	Input	Common voltage
7	DV _{DD}	Power	Power for Digital Circuit
8	MODE	Input	DE/SYNC mode select (*1)
9	DE	Input	Data input enable
10	VS	Input	Vertical Sync Input
11	HS	Input	Horizontal Sync Input
12	B7	Input	8bit Data for Blue
:	:		
19	B0		
20	G7	Input	8bit Data for Green
:	:		
27	G0		
28	R7	Input	8bit Data for Red
:	:		
35	R0		
36	GND	Power	Power GND (0V)
37	DCLK	Input	Sample clock(*2)
38	GND	Power	Power GND (0V)
39	L/R	Input	Left / right selection (*3)
40	U/D	Input	Up/down selection (*3)
41	V _{GH}	Power	Gate ON Voltage
42	V _{GL}	Power	Gate OFF Voltage
43	AV _{DD}	Power	Power for Analog Circuit
44	RESET	Input	Global reset pin (*4)
45	NC	-	No connection
46	V _{COM}	Input	Common Voltage
47	DITHB	Input	Dithering function (*5)
48	GND	Power	Power GND (0V)
49	NC	-	No connection
50	NC		

Note:

- * 1: DE/SYNC mode select. Normally pull high.
When select DE mode, MODE="1", VS and HS must pull high.
When select SYNC mode, MODE="0", DE must be grounded.
- * 2: Data shall be latched at the falling edge of DCLK.
- * 3: Selection of scanning mode

Setting of scan control input		Scanning direction
U/D	L/R	
GND	DV _{DD}	Up to down, left to right
DV _{DD}	GND	Down to up, right to left
GND	GND	Up to down, right to left
DV _{DD}	DV _{DD}	Down to up, left to right

- *4: Global reset pin. Active low to enter reset state. Suggest to connect with an RC reset circuit for stability. Normally pull high.
- *5: Dithering function enable control, normally pull high.
When DITHB="1", Disable internal dithering function.
When DITHB="0", Enable internal dithering function.

5. Absolute Maximum Ratings

Items	Symbol	Min.	Max.	Unit	Condition
Power voltage	DV _{DD}	-0.3	5.0	V	
	AV _{DD}	6.5	13.5	V	
	V _{GH}	-0.3	40.0	V	
	V _{GL}	-20.0	0.3	V	
	V _{GH} -V _{GL}	-	40.0	V	
Operating Temperature	T _{OP}	-20	60	°C	No Condensation
Storage Temperature	T _{ST}	-30	80	°C	No Condensation

Note:

- *1. This rating applies to all parts of the module. And should not be exceeded.
- *2. The operating temperature only guarantees operation of the circuit. The contrast, response speed, and the other specification related to electro-optical display quality is determined at the room temperature, T_{OP}=25.
- *3. Ambient temperature when the backlight is lit (reference value)
- *4. Any Stresses exceeding the Absolute Maximum Ratings may cause substantial damage to the device. Functional operation of this device at other conditions beyond those listed in the specification is not implied and prolonged exposure to extreme conditions may affect device reliability.

6. Electrical Characteristics

6.1 DC Characteristics

Items	Symbol	Min.	Typ.	Max.	Unit	Remark
Power voltage	DV _{DD}	3.0	3.3	3.6	V	*2
	AV _{DD}	10.2	10.4	10.6	V	
	V _{GH}	15.3	16.0	16.7	V	
	V _{GL}	-7.7	-7.0	-6.3	V	
Input signal voltage	V _{COM}	3.6	3.8	4.0	V	
Input logic high voltage	V _{IH}	0.7V _{DD}	-	DV _{DD}	V	*3
Input logic low voltage	V _{IL}	0	-	0.3DV _{DD}	V	

Note:

- *1. Be sure to apply DV_{DD} and V_{GL} to the LCD first, and then apply V_{GH}.
- *2: DV_{DD} setting should match the signals output voltage (refer to Note 3) of customer's system board.
- *3: DCLK, HS, VS, RESET, U/D, L/R, DE, R0~R7, G0~G7, B0~B7, MODE, DITHB.

6.2 Current Consumption

Items	Symbol	Min.	Typ.	Max.	Unit	Remark
Current for Driver	I _{GH}	-	0.2	1.0	mA	V _{GH} = 16.0V
	I _{GL}	-	0.2	1.0	mA	V _{GL} = -7.0V
	IDV _{DD}	-	4.0	10	mA	DV _{DD} =3.3V
	I _{AV} _{DD}	-	20	50	mA	AV _{DD} =10.4V

6.3 LED Backlight Circuit Characteristics

Top=25°C

Items	Symbol	MIN.	TYP.	MAX.	Unit	Note
Forward Voltage	V _f	8.8		10.5	V	
Forward Current	I _f	-	230	-	mA	

Cautions:

Exceeding the recommended driving current could cause substantial damage to the backlight and shorten its lifetime.

6.4 Power Sequence

6.4.1 Power on:

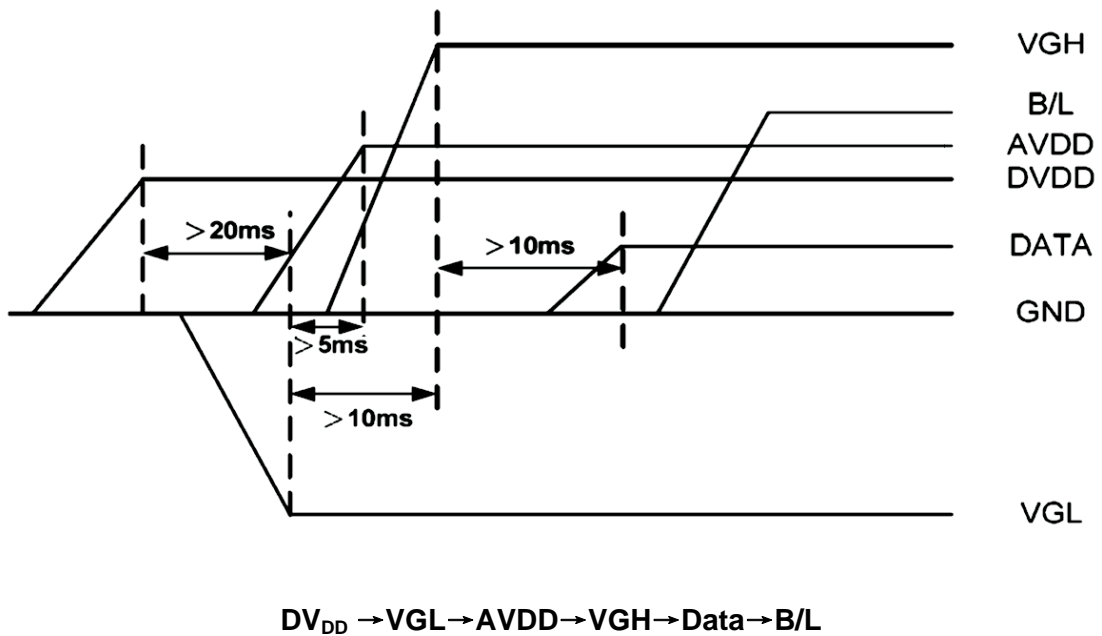

6.4.2 Power off:

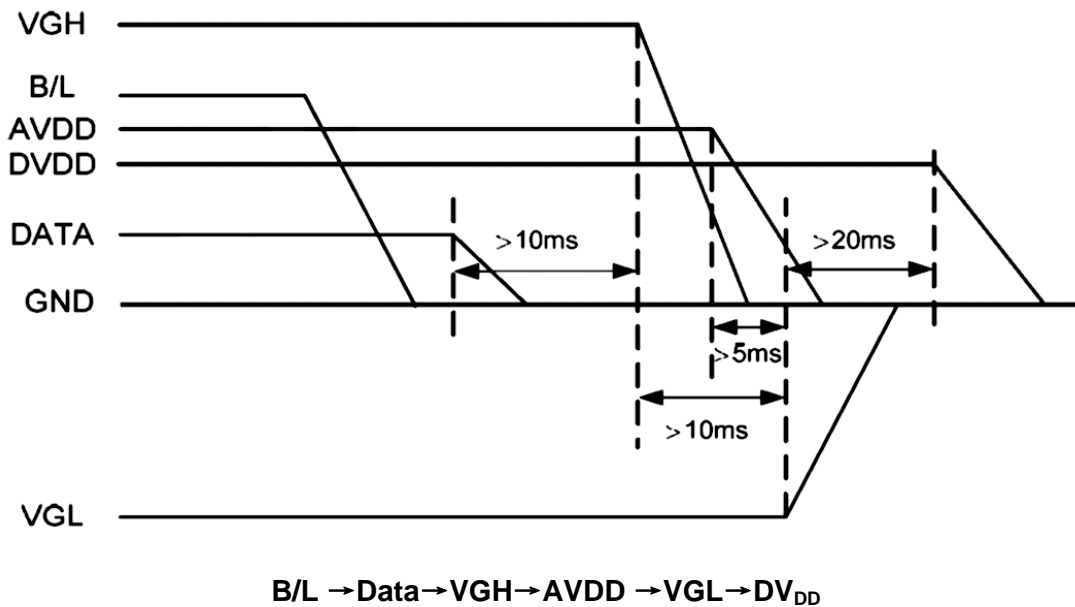

Note :Data include R0~R7,B0~B7,G0~G7,U/D,L/R,DCLK,HS,VS,DE.

7. AC Characteristics

7.1 Timing Characteristics

Item	Symbol	MIN.	TYP.	MAX.	Unit	Remark
HS setup time	Thst	8	-	-	ns	
HS hold time	Thhd	8	-	-	ns	
VS setup time	Tvst	8	-	-	ns	
VS hold time	Tvhd	8	-	-	ns	
Data setup time	Tdsu	8	-	-	ns	
Data hole time	Tdhd	8	-	-	ns	
DE setup time	Tesu	8	-	-	ns	
DV _{DD} Power On Slew rate	TPOR	-	-	20	ms	From 0 to 90% DV _{DD}
DCLK cycle time	Tcph	20	-	-	ns	
DCLK pulse duty	Tcwh	40	50	60	%	

Note: For the details of the timing, please see the Driver IC data sheet.

7.2 Input Clock and Data Timing Diagram

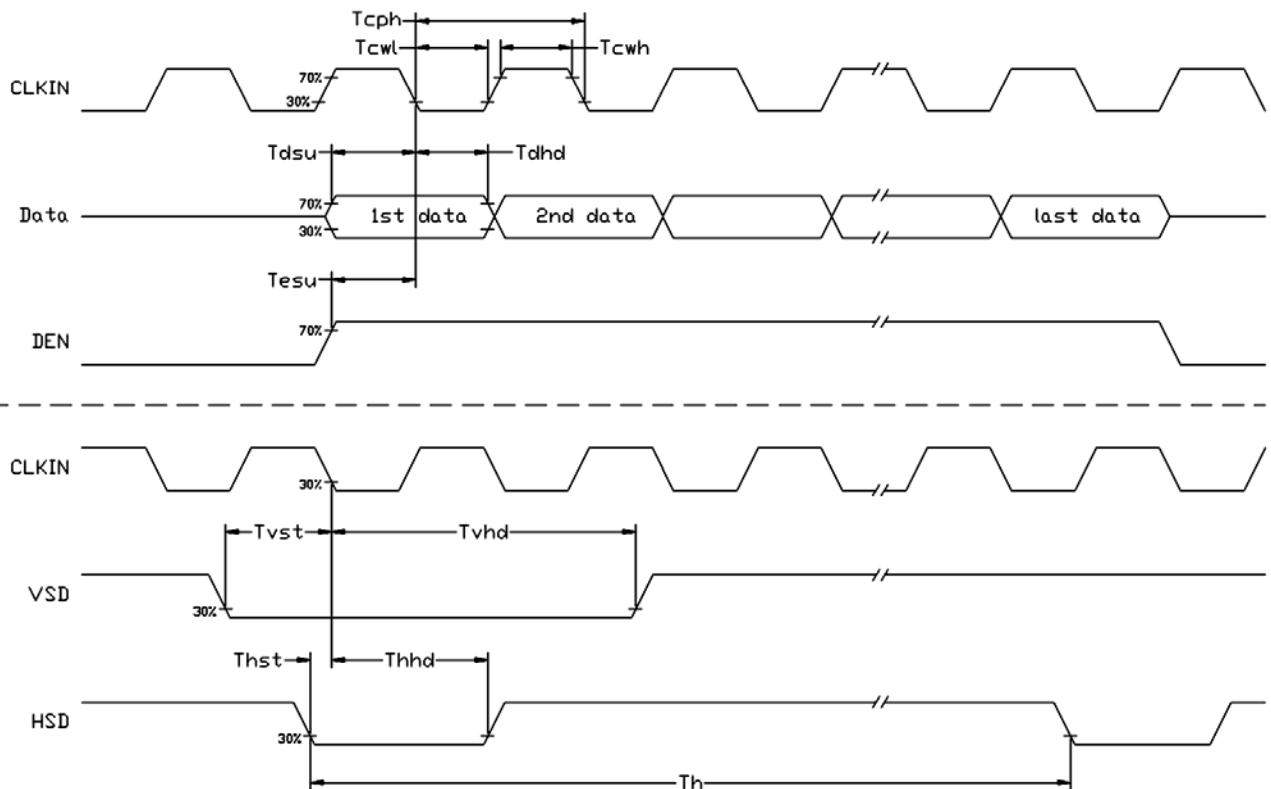

7.3 Timing

Item	Symbol	MIN.	TYP.	MAX.	Unit	Remark
Horizontal Display Area	thd	-	800	-	DCLK	
DCLK Frequency	fclk	26.4	33.3	46.8	MHz	
One Horizontal Line	th	862	1056	1200	DCLK	
HS pulse width	thpw	1	-	40	DCLK	
HS Blanking	thb	46	46	46	DCLK	
HS Front Porch	thfp	16	210	354	DCLK	
Vertical Display Area	tvd	-	480	-	TH	
VS period time	tv	510	525	650	TH	
VS pulse width	tvpw	1	-	20	TH	
VS Blanking	tvb	23	23	23	TH	
VS Front Porch	tvfp	7	22	147	TH	

7.4 Data Input Format

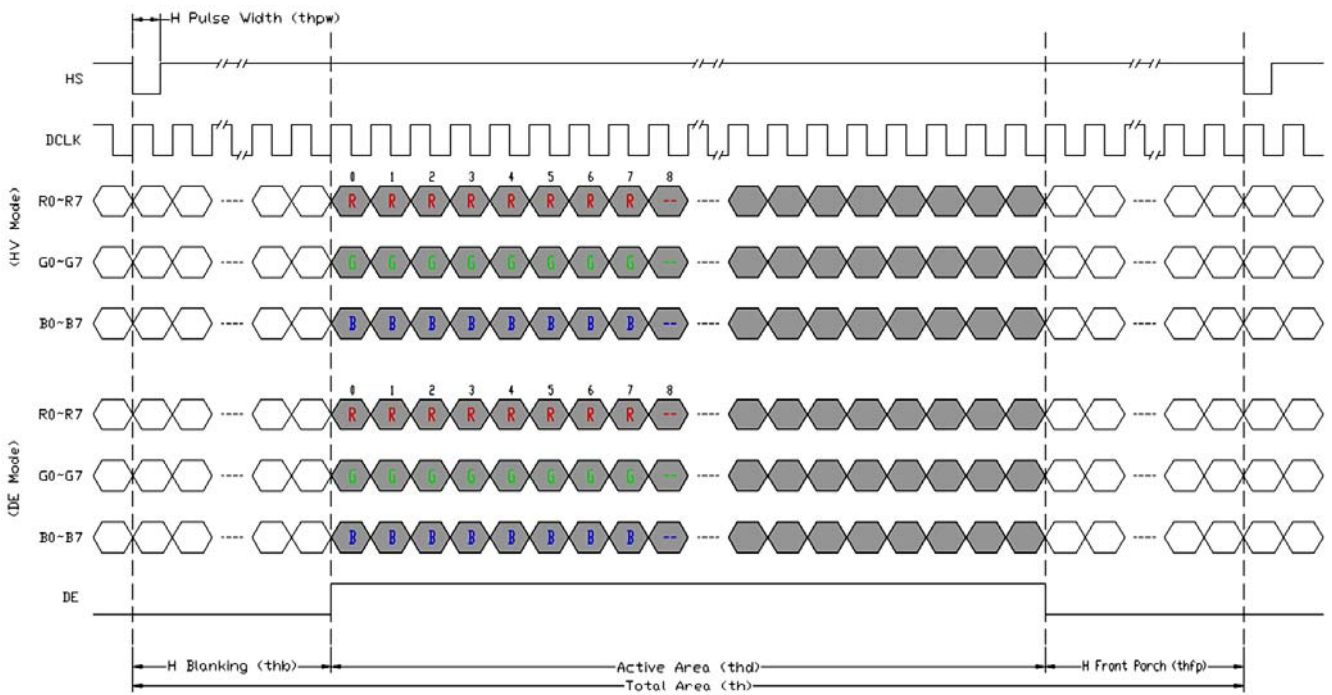

Figure 6-4-1 Horizontal input timing diagram.

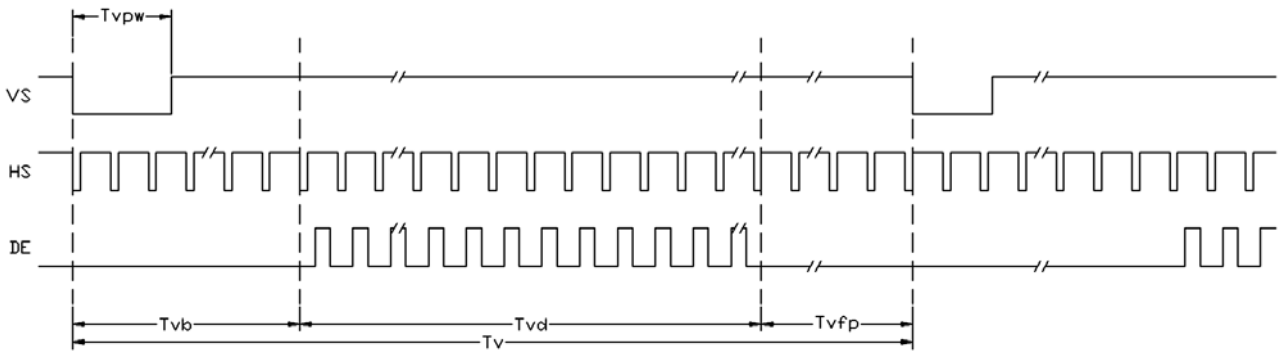

Figure 6-4-2 Vertical input timing diagram.

7.5 Optical Characteristics

Item	Symbol	Condition	MIN.	TYP.	MAX.	UNIT	Note.
Viewing angle (CR ≥ 10)	θ_L	9 o'clock	60	70	-	degree	*2
	θ_R	3 o'clock	60	70	-		
	θ_T	12 o'clock	40	50	-		
	θ_B	6 o'clock	60	70	-		
Response Time	T_f	Normal $\theta=0^\circ$	-	10	20	msec	*3
	T_r		-	15	30	msec	
Contrast ratio	CR		400	500	-	-	*1
Color chromaticlty	W_X		0.26	0.31	0.26	-	
	W_Y		0.28	0.33	0.38	-	
Luminance	L		-	900	-	cd/m ²	*4
Luminance uniformity	Y_U		70	75	-	%	*4

Note:

*1. Definition of Contrast Ratio

The contrast ratio could be calculate by the following expression:

Contrast Ratio (CR) = Luminanc with all pixels white / Luminance with all pixels black

*2 Definition of Viewing Angle

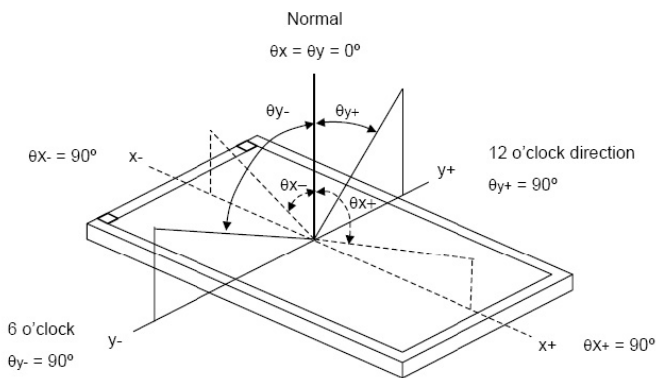

*3 Definition of response time

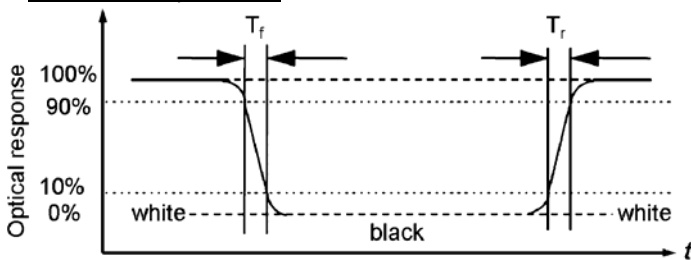

*4 Definition of Luminance Uniformity

Luminance uniformity (Lu)=

Min. Luminance form pt1~pt9 / Max Luminance form Pt1~pt9

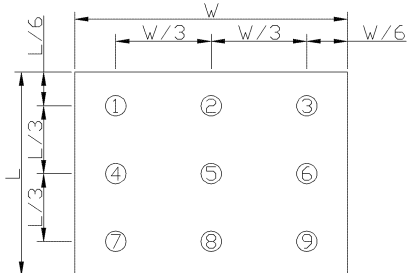

8. Precautions of using LCD Modules

Mounting

- Mounting must use holes arranged in four corners or four sides.
- The mounting structure so provide even force on to LCD module. Uneven force (ex. Twisted stress) should not applied to the module. And the case on which a module is mounted should have sufficient strength so that external force is not transmitted directly to the module.
- It is suggested to attach a transparent protective plate to the surface in order to protect the polarizer. It should have sufficient strength in order to the resist external force.
- The housing should adopt radiation structure to satisfy the temperature specification.
- Acetic acid type and chlorine type materials for the cover case are not desirable because the former generates corrosive gas of attacking the polarizer at high temperature and the latter causes circuit break by electro-chemical reaction.
- Do not touch, push or rub the exposed polarizers with glass, tweezers or anything harder than HB pencil lead. Never rub with dust clothes with chemical treatment. Do not touch the surface of polarizer for bare hand or greasy cloth.(Some cosmetics deteriorate the polarizer.)
- When the surface becomes dusty, please wipe gently with absorbent cotton or other soft materials like chamois soaks with petroleum benzine. Normal-hexane is recommended for cleaning the adhesives used to attach front / rear polarizers. Do not use acetone, toluene and alcohol because they cause chemical damage to the polarizer.
- Wipe off saliva or water drops as soon as possible. Their long time contact with polarizer

Operating

- The spike noise causes the mis-operation of circuits. It should be within the $\pm 200\text{mV}$ level (Over and under shoot voltage)
- Response time depends on the temperature.(In lower temperature, it becomes longer.)
- Brightness depends on the temperature. (In lower temperature, it becomes lower.) And in lower temperature, response time(required time that brightness is stable after turned on) becomes longer.
- Be careful for condensation at sudden temperature change. Condensation makes damage to polarizer or electrical contacted parts. And after fading condensation, smear or spot will occur.
- When fixed patterns are displayed for a long time, remnant image is likely to occur.
- Module has high frequency circuits. Sufficient suppression to the electromagnetic interference shall be done by system manufacturers. Grounding and shielding methods may be important to minimized the interference

Electrostatic Discharge Control

Since a module is composed of electronic circuits, it is not strong to electrostatic discharge. Make certain that treatment persons are connected to ground through wrist band etc. And don't touch interface pin directly.

Strong Light Exposure

Strong light exposure causes degradation of polarizer and color filter.

Storage

When storing modules as spares for a long time, the following precautions are necessary.

- Store them in a dark place. Do not expose the module to sunlight or fluorescent light. Keep the temperature between 5°C and 35°C at normal humidity.
- The polarizer surface should not come in contact with any other object. It is recommended that they be stored in the container in which they were shipped.

Protection Film

- When the protection film is peeled off, static electricity is generated between the film and polarizer. This should be peeled off slowly and carefully by people who are electrically grounded and with well ion-blown equipment or in such a condition, etc.
- The protection film is attached to the polarizer with a small amount of glue. If some stress is applied to rub the protection film against the polarizer during the time you peel off the film, the glue is apt to be main on the polarizer. Please carefully peel off the protection film without rubbing it against the polarizer.
- When the module with protection film attached is stored for a long time, sometimes there remains a very small amount of glue still on the polarizer after the protection film is peeled off.
- You can remove the glue easily. When the glue remains on the polarizer surface or its vestige is recognized, please wipe them off with absorbent cotton waste or other soft material like chamois soaked with normal-hexane.

Transportation

The LCD modules should be no falling and violent shocking during transportation, and also should avoid excessive press, water, damp and sunshine.