

LMV931 Single / LMV932 Dual / LMV934 Quad 1.8V, RRIO Operational Amplifiers

General Description

The LMV931/LMV932/LMV934 are low voltage, low power operational amplifiers. LMV931/LMV932/LMV934 are guaranteed to operate from +1.8V to +5.0V supply voltages and have rail-to-rail input and output. LMV931/LMV932/LMV934 input common mode voltage extends 200mV beyond the supplies which enables user enhanced functionality beyond the supply voltage range. The output can swing rail-to-rail unloaded and within 105mV from the rail with 600Ω load at 1.8V supply. The LMV931/LMV932/LMV934 are optimized to work at 1.8V which make them ideal for portable two-cell battery powered systems and single cell Li-Ion systems.

LMV931/LMV932/LMV934 exhibit excellent speed-power ratio, achieving 1.4MHz gain bandwidth product at 1.8V supply voltage with very low supply current. The LMV931/LMV932/LMV934 are capable of driving a 600Ω load and up to 1000pF capacitive load with minimal ringing. LMV931/LMV932/LMV934 have a high DC gain of 101dB, making them suitable for low frequency applications.

The single LMV931 is offered in space saving SC70-5 and SOT23-5 packages. The dual LMV932 are in MSOP-8 and SOIC-8 packages and the quad LMV934 are in TSSOP-14 and SOIC-14 packages. These small packages are ideal solutions for area constrained PC boards and portable electronics such as cellular phones and PDAs.

Features

(Typical 1.8V Supply Values; Unless Otherwise Noted)

- Guaranteed 1.8V, 2.7V and 5V specifications
- Output swing
 - w/600Ω load 80mV from rail
 - w/2kΩ load 30mV from rail
- V_{CM} 200mV beyond rails
- Supply current (per channel) 100μA
- Gain bandwidth product 1.4MHz
- Maximum V_{OS} 4.0mV
- Ultra tiny packages
- Temperature range -40°C to 125°C

Applications

- Consumer communication
- Consumer computing
- PDAs
- Audio pre-amp
- Portable/battery-powered electronic equipment
- Supply current monitoring
- Battery monitoring

Typical Application

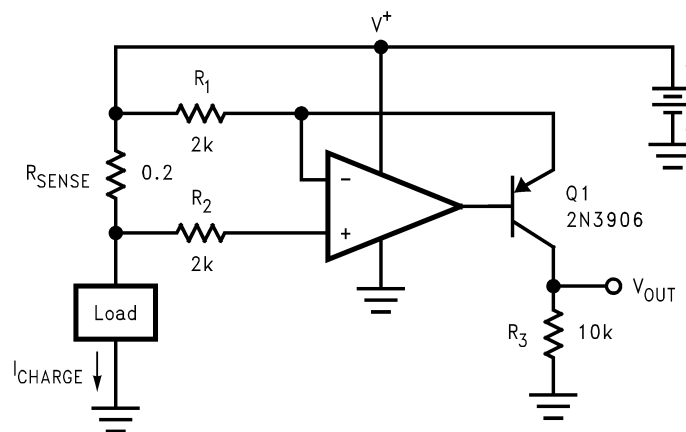

$$V_{OUT} = \frac{R_{SENSE} \cdot R_3}{R_1} \cdot I_{CHARGE} = 1\Omega \cdot I_{CHARGE}$$

200326H0

Absolute Maximum Ratings (Note 1)

If Military/Aerospace specified devices are required, please contact the National Semiconductor Sales Office/Distributors for availability and specifications.

ESD Tolerance (Note 2)	
Machine Model	200V
Human Body Model	2000V
Differential Input Voltage	± Supply Voltage
Supply Voltage (V ⁺ -V ⁻)	5.5V
Output Short Circuit to V ⁺ (Note 3)	
Output Short Circuit to V ⁻ (Note 3)	
Storage Temperature Range	-65°C to 150°C
Junction Temperature (Note 4)	150°C
Mounting Temp.	

Infrared or Convection (20 sec)

235°C

Operating Ratings (Note 1)

Supply Voltage Range	1.8V to 5.0V
Temperature Range	-40°C to 125°C
Thermal Resistance (θ _{JA})	
SC70-5	414°C/W
SOT23-5	265°C/W
MSOP-8	235°C/W
SOIC-8	175°C/W
TSSOP-14	155°C/W
SOIC-14	127°C/W

1.8V DC Electrical Characteristics

Unless otherwise specified, all limits guaranteed for T_J = 25°C. V⁺ = 1.8V, V⁻ = 0V, V_{CM} = V⁺/2, V_O = V⁺/2 and R_L > 1 MΩ. **Boldface** limits apply at the temperature extremes. See (Note 10)

Symbol	Parameter	Condition	Min (Note 6)	Typ (Note 5)	Max (Note 6)	Units	
V _{OS}	Input Offset Voltage	LMV931 (Single)		1	4 6	mV	
		LMV932 (Dual)		1	5.5	mV	
		LMV934 (Quad)			7.5		
TCV _{OS}	Input Offset Voltage Average Drift			5.5		µV/°C	
I _B	Input Bias Current			15	35 50	nA	
I _{OS}	Input Offset Current			13	25 40	nA	
I _S	Supply Current (per channel)			103	185 205	µA	
CMRR	Common Mode Rejection Ratio	LMV931, 0 ≤ V _{CM} ≤ 0.6V	60	78		dB	
		1.4V ≤ V _{CM} ≤ 1.8V (Note 8)	55				
		LMV932 and LMV934 0 ≤ V _{CM} ≤ 0.6V	55	76			
		1.4V ≤ V _{CM} ≤ 1.8V (Note 8)	50				
		-0.2V ≤ V _{CM} ≤ 0V	50	72			
		1.8V ≤ V _{CM} ≤ 2.0V					
PSRR	Power Supply Rejection Ratio	1.8V ≤ V ⁺ ≤ 5V	75 70	100		dB	
CMVR	Input Common-Mode Voltage Range	For CMRR Range ≥ 50dB	T _A = 25°C	V ⁻ -0.2	-0.2 to 2.1	V ⁺ +0.2	V
			T _A = -40°C to 85°C	V ⁻		V ⁺	
			T _A = 125°C	V ⁻ +0.2		V ⁺ -0.2	
A _V	Large Signal Voltage Gain LMV931 (Single)	R _L = 600Ω to 0.9V, V _O = 0.2V to 1.6V, V _{CM} = 0.5V	77 73	101		dB	
		R _L = 2kΩ to 0.9V, V _O = 0.2V to 1.6V, V _{CM} = 0.5V	80 75	105			
	Large Signal Voltage Gain LMV932 (Dual) LMV934 (Quad)	R _L = 600Ω to 0.9V, V _O = 0.2V to 1.6V, V _{CM} = 0.5V	75 72	90		dB	
		R _L = 2kΩ to 0.9V, V _O = 0.2V to 1.6V, V _{CM} = 0.5V	78 75	100			

1.8V DC Electrical Characteristics (Continued)

Unless otherwise specified, all limits guaranteed for $T_J = 25^\circ\text{C}$. $V^+ = 1.8\text{V}$, $V^- = 0\text{V}$, $V_{\text{CM}} = V^+/2$, $V_O = V^+/2$ and $R_L > 1\text{M}\Omega$. **Boldface** limits apply at the temperature extremes. See (Note 10)

Symbol	Parameter	Condition	Min (Note 6)	Typ (Note 5)	Max (Note 6)	Units
V_O	Output Swing	$R_L = 600\Omega$ to 0.9V $V_{\text{IN}} = \pm 100\text{mV}$	1.65	1.72		V
			1.63	0.077	0.105 0.120	
		$R_L = 2\text{k}\Omega$ to 0.9V $V_{\text{IN}} = \pm 100\text{mV}$	1.75	1.77		
			1.74	0.024	0.035 0.04	
I_O	Output Short Circuit Current	Sourcing, $V_O = 0\text{V}$ $V_{\text{IN}} = 100\text{mV}$	4	8		mA
		Sinking, $V_O = 1.8\text{V}$ $V_{\text{IN}} = -100\text{mV}$	3.3	9		
			7			
			5			

1.8V AC Electrical Characteristics

Unless otherwise specified, all limits guaranteed for $T_J = 25^\circ\text{C}$. $V^+ = 1.8\text{V}$, $V^- = 0\text{V}$, $V_{\text{CM}} = V^+/2$, $V_O = V^+/2$ and $R_L > 1\text{M}\Omega$. **Boldface** limits apply at the temperature extremes. See (Note 10)

Symbol	Parameter	Conditions	Min (Note 6)	Typ (Note 5)	Max (Note 6)	Units
SR	Slew Rate	(Note 7)		0.35		V/ μs
GBW	Gain-Bandwidth Product			1.4		MHz
Φ_m	Phase Margin			67		deg
G_m	Gain Margin			7		dB
e_n	Input-Referred Voltage Noise	$f = 1\text{kHz}$, $V_{\text{CM}} = 0.5\text{V}$		60		$\frac{\text{nV}}{\sqrt{\text{Hz}}}$
i_n	Input-Referred Current Noise	$f = 1\text{kHz}$		0.06		$\frac{\text{pA}}{\sqrt{\text{Hz}}}$
THD	Total Harmonic Distortion	$f = 1\text{kHz}$, $A_V = +1$ $R_L = 600\Omega$, $V_{\text{IN}} = 1\text{V}_{\text{PP}}$		0.023		%
	Amp-to-Amp Isolation	(Note 9)		123		dB

2.7V DC Electrical Characteristics

Unless otherwise specified, all limits guaranteed for $T_J = 25^\circ\text{C}$. $V^+ = 2.7\text{V}$, $V^- = 0\text{V}$, $V_{\text{CM}} = V^+/2$, $V_O = V^+/2$ and $R_L > 1\text{M}\Omega$. **Boldface** limits apply at the temperature extremes. See (Note 10)

Symbol	Parameter	Condition	Min (Note 6)	Typ (Note 5)	Max (Note 6)	Units
V_{OS}	Input Offset Voltage	LMV931 (Single)		1	4 6	mV
		LMV932 (Dual)		1	5.5	mV
		LMV934 (Quad)			7.5	
TCV_{OS}	Input Offset Voltage Average Drift			5.5		$\mu\text{V}/^\circ\text{C}$
I_B	Input Bias Current			15	35 50	nA
I_{OS}	Input Offset Current			8	25 40	nA
I_S	Supply Current (per channel)			105	190 210	μA

2.7V DC Electrical Characteristics (Continued)

Unless otherwise specified, all limits guaranteed for $T_J = 25^\circ\text{C}$. $V^+ = 2.7\text{V}$, $V^- = 0\text{V}$, $V_{\text{CM}} = V^+/2$, $V_O = V^+/2$ and $R_L > 1\text{M}\Omega$. **Boldface** limits apply at the temperature extremes. See (Note 10)

Symbol	Parameter	Condition	Min (Note 6)	Typ (Note 5)	Max (Note 6)	Units	
CMRR	Common Mode Rejection Ratio	LMV931, $0 \leq V_{\text{CM}} \leq 1.5\text{V}$ $2.3\text{V} \leq V_{\text{CM}} \leq 2.7\text{V}$ (Note 8)	60 55	81		dB	
		LMV932 and LMV934 $0 \leq V_{\text{CM}} \leq 1.5\text{V}$ $2.3\text{V} \leq V_{\text{CM}} \leq 2.7\text{V}$ (Note 8)	55 50	80			
		$-0.2\text{V} \leq V_{\text{CM}} \leq 0\text{V}$ $2.7\text{V} \leq V_{\text{CM}} \leq 2.9\text{V}$	50	74			
PSRR	Power Supply Rejection Ratio	$1.8\text{V} \leq V^+ \leq 5\text{V}$ $V_{\text{CM}} = 0.5\text{V}$	75 70	100		dB	
V_{CM}	Input Common-Mode Voltage Range	For CMRR Range $\geq 50\text{dB}$	$T_A = 25^\circ\text{C}$	-0.2 to 3.0	$V^+ + 0.2$	V	
			$T_A = -40^\circ\text{C}$ to 85°C		V^-		V^+
			$T_A = 125^\circ\text{C}$		$V^- + 0.2$		$V^+ - 0.2$
A_V	Large Signal Voltage Gain LMV931 (Single)	$R_L = 600\Omega$ to 1.35V , $V_O = 0.2\text{V}$ to 2.5V	87 86	104		dB	
		$R_L = 2\text{k}\Omega$ to 1.35V , $V_O = 0.2\text{V}$ to 2.5V	92 91	110			
	Large Signal Voltage Gain LMV932 (Dual) LMV934 (Quad)	$R_L = 600\Omega$ to 1.35V , $V_O = 0.2\text{V}$ to 2.5V	78 75	90		dB	
		$R_L = 2\text{k}\Omega$ to 1.35V , $V_O = 0.2\text{V}$ to 2.5V	81 78	100			
V_O	Output Swing	$R_L = 600\Omega$ to 1.35V $V_{\text{IN}} = \pm 100\text{mV}$	2.55 2.53	2.62		V	
			0.083	0.110 0.130			
		$R_L = 2\text{k}\Omega$ to 1.35V $V_{\text{IN}} = \pm 100\text{mV}$	2.65 2.64	2.675			
			0.025	0.04 0.045			
I_O	Output Short Circuit Current	Sourcing, $V_O = 0\text{V}$ $V_{\text{IN}} = 100\text{mV}$	20 15	30		mA	
		Sinking, $V_O = 0\text{V}$ $V_{\text{IN}} = -100\text{mV}$	18 12	25			

2.7V AC Electrical Characteristics

Unless otherwise specified, all limits guaranteed for $T_J = 25^\circ\text{C}$. $V^+ = 2.7\text{V}$, $V^- = 0\text{V}$, $V_{\text{CM}} = 1.0\text{V}$, $V_O = 1.35\text{V}$ and $R_L > 1\text{M}\Omega$. **Boldface** limits apply at the temperature extremes. See (Note 10)

Symbol	Parameter	Conditions	Min (Note 6)	Typ (Note 5)	Max (Note 6)	Units
SR	Slew Rate	(Note 7)		0.4		V/ μs
GBW	Gain-Bandwidth Product			1.4		MHz
Φ_m	Phase Margin			70		deg
G_m	Gain Margin			7.5		dB
e_n	Input-Referred Voltage Noise	$f = 1\text{kHz}$, $V_{\text{CM}} = 0.5\text{V}$		57		$\frac{\text{nV}}{\sqrt{\text{Hz}}}$
i_n	Input-Referred Current Noise	$f = 1\text{kHz}$		0.082		$\frac{\text{pA}}{\sqrt{\text{Hz}}}$

2.7V AC Electrical Characteristics (Continued)

Unless otherwise specified, all limits guaranteed for $T_J = 25^\circ\text{C}$. $V^+ = 2.7\text{V}$, $V^- = 0\text{V}$, $V_{\text{CM}} = 1.0\text{V}$, $V_O = 1.35\text{V}$ and $R_L > 1\text{M}\Omega$. **Boldface** limits apply at the temperature extremes. See (Note 10)

Symbol	Parameter	Conditions	Min (Note 6)	Typ (Note 5)	Max (Note 6)	Units
THD	Total Harmonic Distortion	$f = 1\text{kHz}$, $A_V = +1$ $R_L = 600\text{k}\Omega$, $V_{\text{IN}} = 1V_{\text{PP}}$		0.022		%
	Amp-to-Amp Isolation	(Note 9)		123		dB

5V DC Electrical Characteristics

Unless otherwise specified, all limits guaranteed for $T_J = 25^\circ\text{C}$. $V^+ = 5\text{V}$, $V^- = 0\text{V}$, $V_{\text{CM}} = V^+/2$, $V_O = V^+/2$ and $R_L > 1\text{M}\Omega$. **Boldface** limits apply at the temperature extremes. See (Note 10)

Symbol	Parameter	Condition	Min (Note 6)	Typ (Note 5)	Max (Note 6)	Units	
V_{OS}	Input Offset Voltage	LMV931 (Single)		1	4 6	mV	
		LMV932 (Dual) LMV934 (Quad)		1	5.5 7.5	mV	
TCV_{OS}	Input Offset Voltage Average Drift			5.5		$\mu\text{V}/^\circ\text{C}$	
I_{B}	Input Bias Current			14	35 50	nA	
I_{OS}	Input Offset Current			9	25 40	nA	
I_{S}	Supply Current (per channel)			116	210 230	μA	
CMRR	Common Mode Rejection Ratio	$0 \leq V_{\text{CM}} \leq 3.8\text{V}$	60	86		dB	
		$4.6\text{V} \leq V_{\text{CM}} \leq 5.0\text{V}$ (Note 8)	55				
		$-0.2\text{V} \leq V_{\text{CM}} \leq 0\text{V}$ $5.0\text{V} \leq V_{\text{CM}} \leq 5.2\text{V}$	50	78			
PSRR	Power Supply Rejection Ratio	$1.8\text{V} \leq V^+ \leq 5\text{V}$ $V_{\text{CM}} = 0.5\text{V}$	75 70	100		dB	
CMVR	Input Common-Mode Voltage Range	For CMRR Range $\geq 50\text{dB}$	$T_A = 25^\circ\text{C}$	$V^- - 0.2$	-0.2 to 5.3	$V^+ + 0.2$	V
			$T_A = -40^\circ\text{C}$ to 85°C	V^-		V^+	
			$T_A = 125^\circ\text{C}$	$V^- + 0.3$		$V^+ - 0.3$	
A_V	Large Signal Voltage Gain LMV931 (Single)	$R_L = 600\Omega$ to 2.5V , $V_O = 0.2\text{V}$ to 4.8V	88 87	102		dB	
		$R_L = 2\text{k}\Omega$ to 2.5V , $V_O = 0.2\text{V}$ to 4.8V	94 93	113			
	Large Signal Voltage Gain LMV932 (Dual) LMV934 (Quad)	$R_L = 600\Omega$ to 2.5V , $V_O = 0.2\text{V}$ to 4.8V	81 78	90		dB	
		$R_L = 2\text{k}\Omega$ to 2.5V , $V_O = 0.2\text{V}$ to 4.8V	85 82	100			
V_O	Output Swing	$R_L = 600\Omega$ to 2.5V $V_{\text{IN}} = \pm 100\text{mV}$	4.855 4.835	4.890		V	
				0.120	0.160 0.180		
		$R_L = 2\text{k}\Omega$ to 2.5V $V_{\text{IN}} = \pm 100\text{mV}$	4.945 4.935	4.967			
				0.037	0.065 0.075		

5V DC Electrical Characteristics (Continued)

Unless otherwise specified, all limits guaranteed for $T_J = 25^\circ\text{C}$. $V^+ = 5\text{V}$, $V^- = 0\text{V}$, $V_{\text{CM}} = V^+/2$, $V_O = V^+/2$ and $R_L > 1\text{M}\Omega$. **Boldface** limits apply at the temperature extremes. See (Note 10)

Symbol	Parameter	Condition	Min (Note 6)	Typ (Note 5)	Max (Note 6)	Units
I_O	Output Short Circuit Current	LMV931, Sourcing, $V_O = 0\text{V}$ $V_{\text{IN}} = 100\text{mV}$	80	100		mA
		Sinking, $V_O = 5\text{V}$ $V_{\text{IN}} = -100\text{mV}$	68 58 45	65		

5V AC Electrical Characteristics

Unless otherwise specified, all limits guaranteed for $T_J = 25^\circ\text{C}$. $V^+ = 5\text{V}$, $V^- = 0\text{V}$, $V_{\text{CM}} = V^+/2$, $V_O = 2.5\text{V}$ and $R_L > 1\text{M}\Omega$. **Boldface** limits apply at the temperature extremes. See (Note 10)

Symbol	Parameter	Conditions	Min (Note 6)	Typ (Note 5)	Max (Note 6)	Units
SR	Slew Rate	(Note 7)		0.42		V/ μs
GBW	Gain-Bandwidth Product			1.5		MHz
Φ_m	Phase Margin			71		deg
G_m	Gain Margin			8		dB
e_n	Input-Referred Voltage Noise	$f = 1\text{kHz}$, $V_{\text{CM}} = 1\text{V}$		50		$\frac{\text{nV}}{\sqrt{\text{Hz}}}$
i_n	Input-Referred Current Noise	$f = 1\text{kHz}$		0.07		$\frac{\text{pA}}{\sqrt{\text{Hz}}}$
THD	Total Harmonic Distortion	$f = 1\text{kHz}$, $A_V = +1$ $R_L = 600\Omega$, $V_O = 1\text{V}_{\text{PP}}$		0.022		%
	Amp-to-Amp Isolation	(Note 9)		123		dB

Note 1: Absolute Maximum Ratings indicate limits beyond which damage to the device may occur. Operating Ratings indicate conditions for which the device is intended to be functional, but specific performance is not guaranteed. For guaranteed specifications and the test conditions, see the Electrical Characteristics.

Note 2: Human body model, $1.5\text{k}\Omega$ in series with 100pF . Machine model, 200Ω in series with 100pF .

Note 3: Applies to both single-supply and split-supply operation. Continuous short circuit operation at elevated ambient temperature can result in exceeding the maximum allowed junction temperature of 150°C . Output currents in excess of 45mA over long term may adversely affect reliability.

Note 4: The maximum power dissipation is a function of $T_{\text{J(MAX)}}$, θ_{JA} , and T_A . The maximum allowable power dissipation at any ambient temperature is $P_D = (T_{\text{J(MAX)}} - T_A) / \theta_{\text{JA}}$. All numbers apply for packages soldered directly into a PC board.

Note 5: Typical Values represent the most likely parametric norm.

Note 6: All limits are guaranteed by testing or statistical analysis.

Note 7: $V^+ = 5\text{V}$. Connected as voltage follower with 5V step input. Number specified is the slower of the positive and negative slew rates.

Note 8: For guaranteed temperature ranges, see Input Common-Mode Voltage Range specifications.

Note 9: Input referred, $V^+ = 5\text{V}$ and $R_L = 100\text{k}\Omega$ connected to 2.5V . Each amp excited in turn with 1kHz to produce $V_O = 3V_{\text{PP}}$.

Note 10: Electrical Table values apply only for factory testing conditions at the temperature indicated. Factory testing conditions result in very limited self-heating of the device such that $T_J = T_A$. No guarantee of parametric performance is indicated in the electrical tables under conditions of internal self-heating where $T_J > T_A$. See Applications section for information of temperature derating of the device. Absolute Maximum Ratings indicated junction temperature limits beyond which the device may be permanently degraded, either mechanically or electrically.

Connection Diagrams

**5-Pin SC70-5/SOT23-5
(LMV931)**

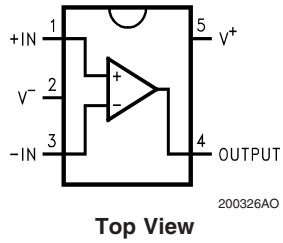

**8-Pin MSOP/SOIC
(LMV932)**

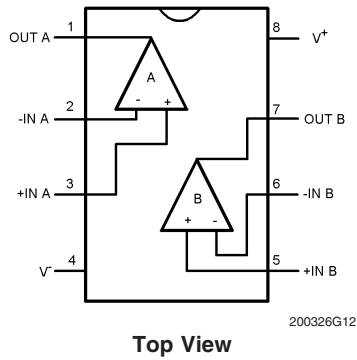

**14-Pin TSSOP/SOIC
(LMV934)**

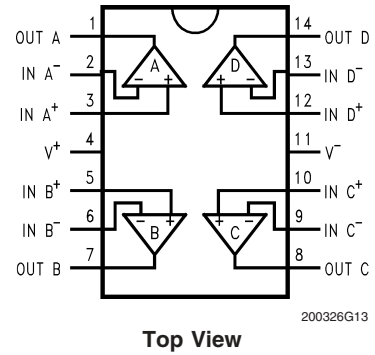

Ordering Information

Package	Part Number	Packaging Marking	Transport Media	NSC Drawing
5-Pin SC70	LMV931MG	A74	1k Units Tape and Reel	MAA05A
	LMV931MGX		3k Units Tape and Reel	
5-Pin SOT23	LMV931MF	A79A	1k Units Tape and Reel	MF05A
	LMV931MFX		3k Units Tape and Reel	
8-Pin MSOP	LMV932MM	A86A	1k Units Tape and Reel	MUA08A
	LMV932MMX		3.5k Units Tape and Reel	
8-Pin SOIC	LMV932MA	LMV932MA	Rails	M08A
	LMV932MAX		2.5k Units Tape and Reel	
14-Pin TSSOP	LMV934MT	LMV934MT	Rails	MTC14
	LMV934MTX		2.5k Units Tape and Reel	
14-Pin SOIC	LMV934MA	LMV934MA	Rails	M14A
	LMV934MAX		2.5k Units Tape and Reel	

Typical Performance Characteristics Unless otherwise specified, $V_S = +5V$, single supply,

$T_A = 25^\circ C$.

Supply Current vs. Supply Voltage (LMV931)

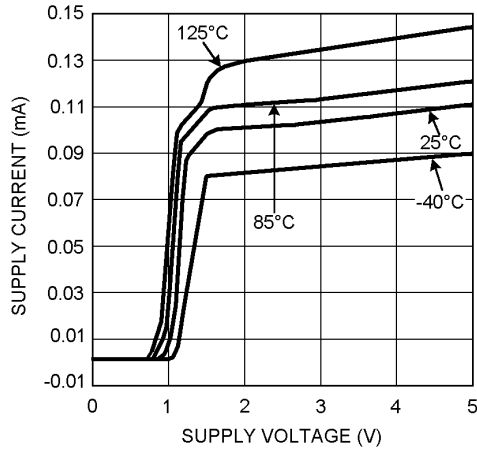

20032622

Sourcing Current vs. Output Voltage

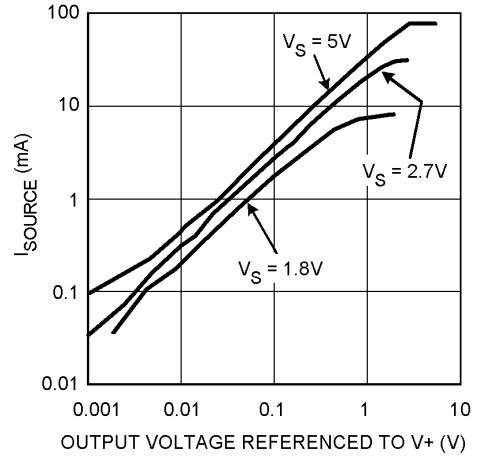

20032625

Sinking Current vs. Output Voltage

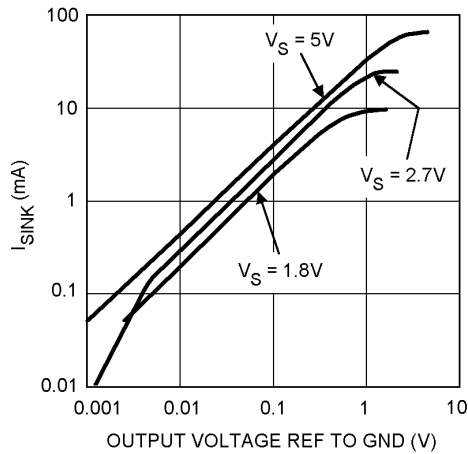

20032628

Output Voltage Swing vs. Supply Voltage

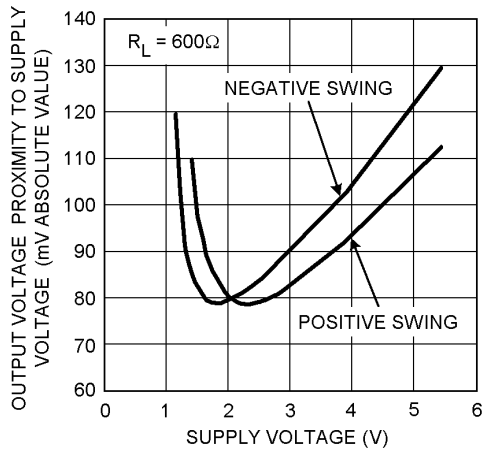

20032649

Output Voltage Swing vs. Supply Voltage

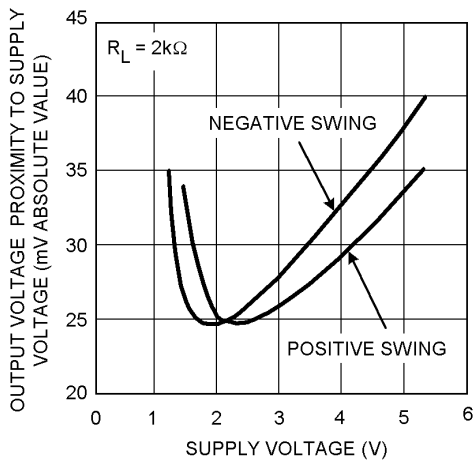

20032650

Gain and Phase vs. Frequency

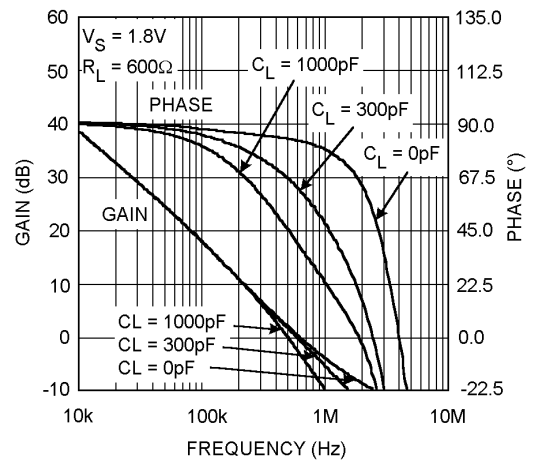

20032668

Typical Performance Characteristics Unless otherwise specified, $V_S = +5V$, single supply, $T_A = 25^\circ C$. (Continued)

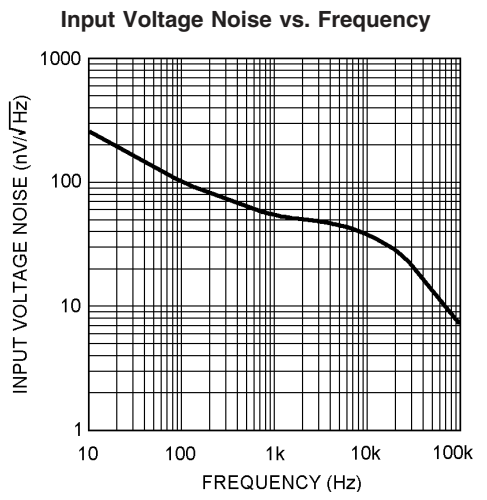
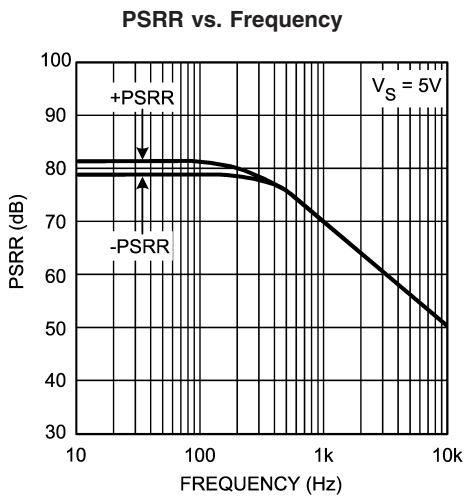
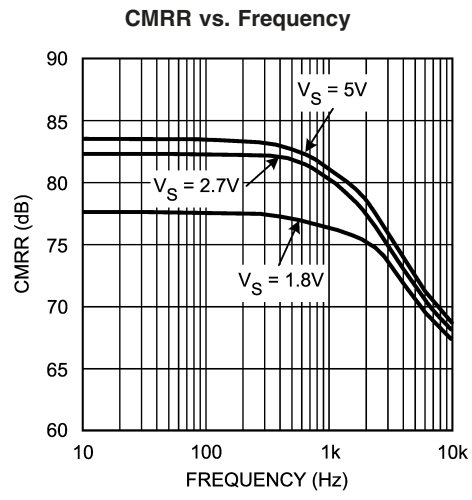
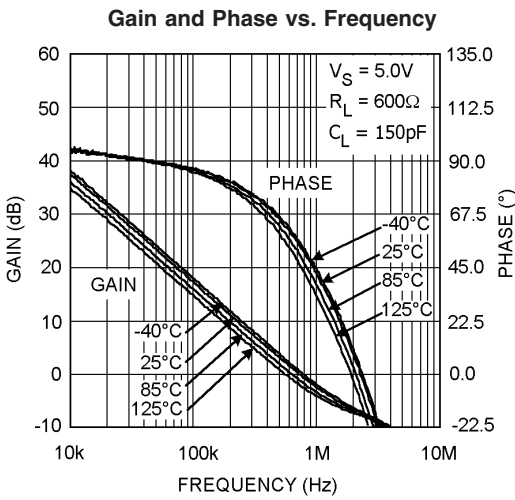
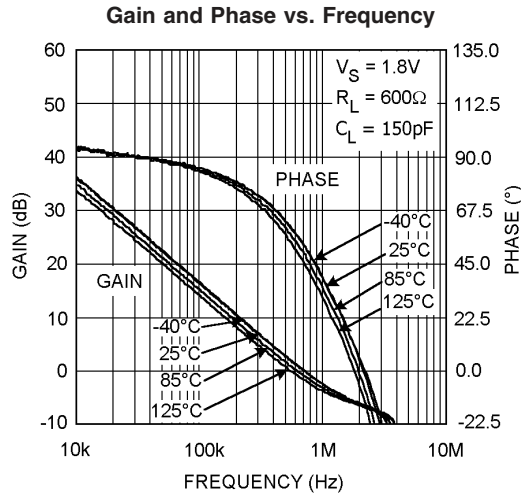
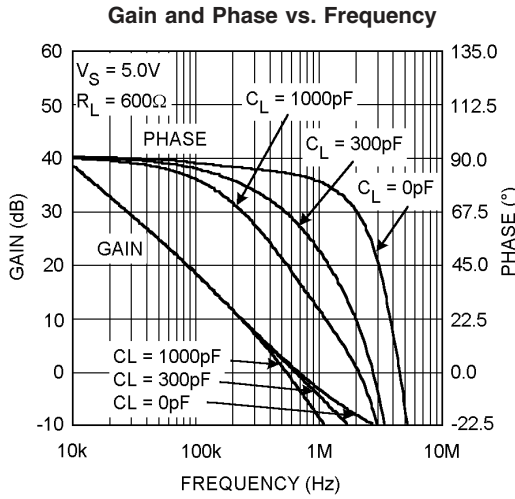

Typical Performance Characteristics Unless otherwise specified, $V_S = +5V$, single supply, $T_A = 25^\circ C$. (Continued)

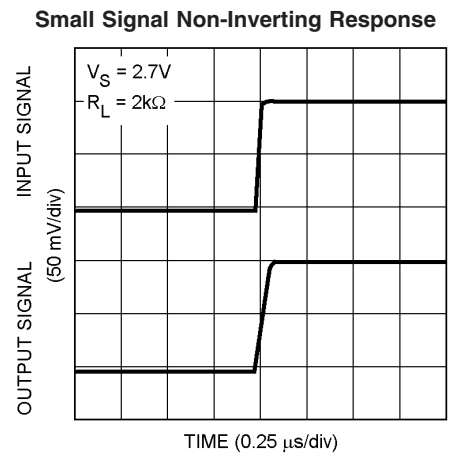
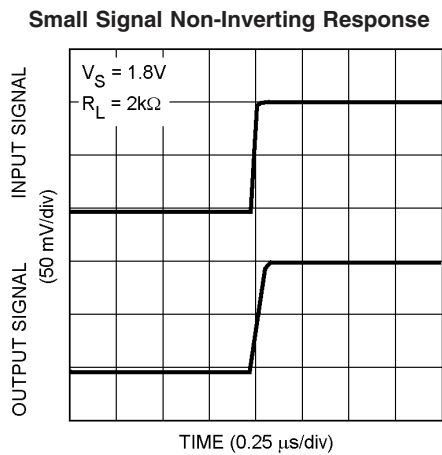
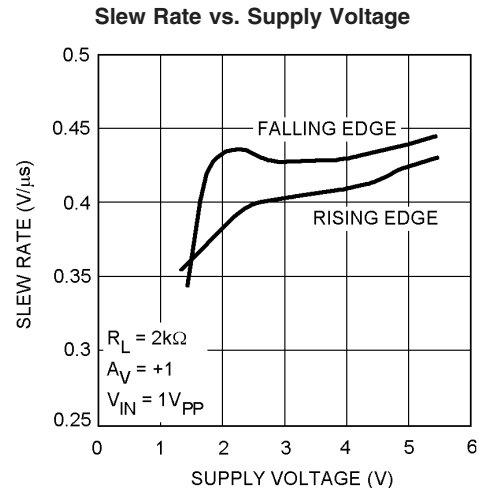
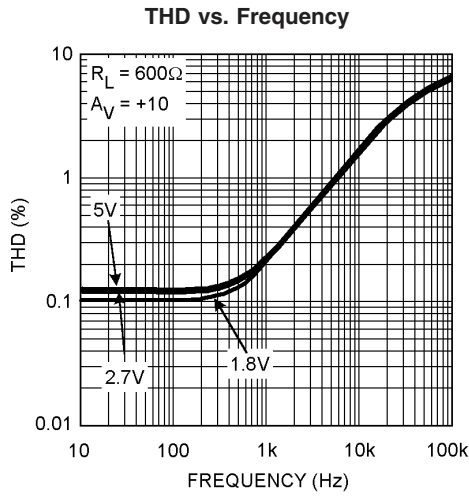
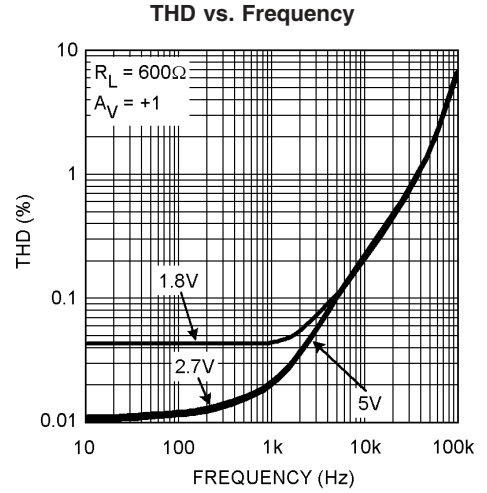
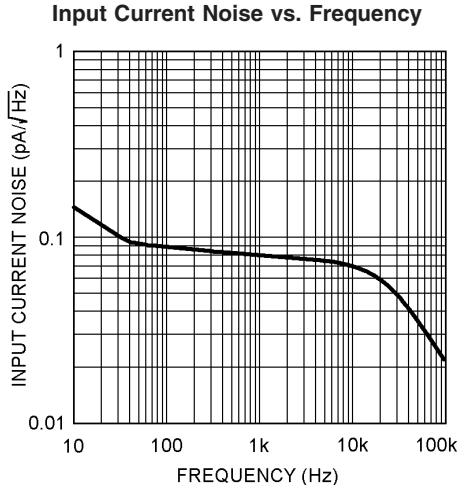

Typical Performance Characteristics Unless otherwise specified, $V_S = +5V$, single supply, $T_A = 25^\circ C$. (Continued)

Small Signal Non-Inverting Response

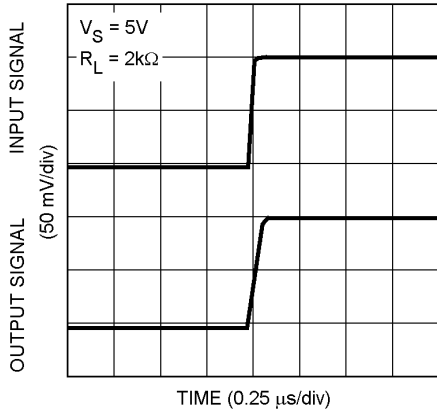

20032672

Large Signal Non-Inverting Response

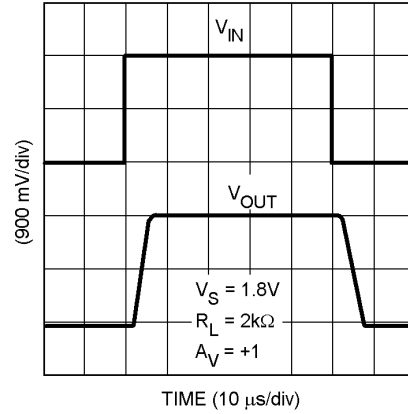

20032673

Large Signal Non-Inverting Response

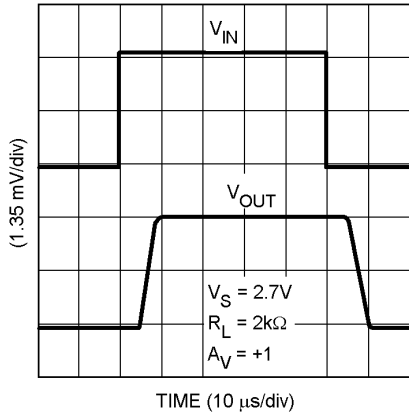

20032674

Large Signal Non-Inverting Response

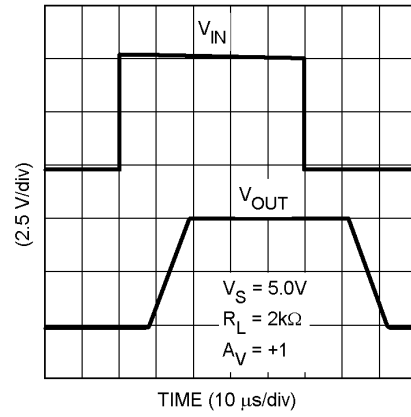

20032675

Short Circuit Current vs. Temperature (Sinking)

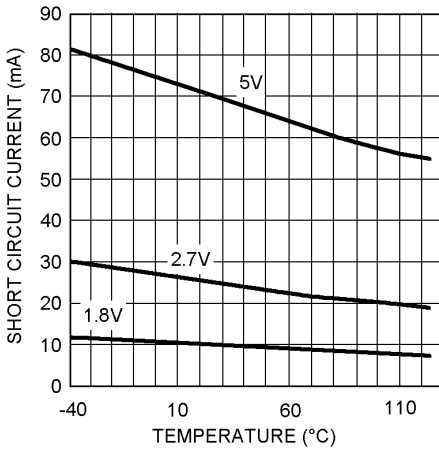

20032676

Short Circuit Current vs. Temperature (Sourcing)

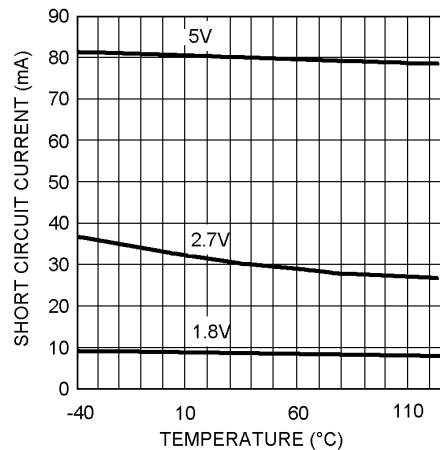

20032677

Typical Performance Characteristics Unless otherwise specified, $V_S = +5V$, single supply, $T_A = 25^\circ C$. (Continued)

Offset Voltage vs. Common Mode Range

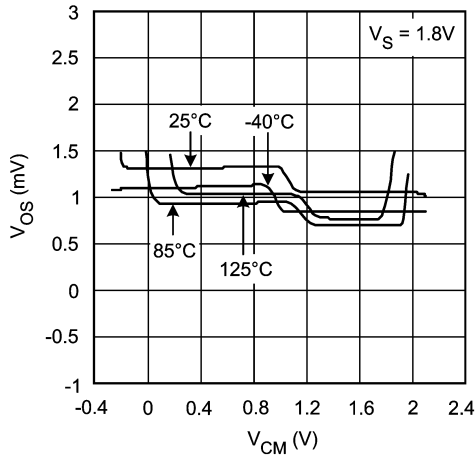

Offset Voltage vs. Common Mode Range

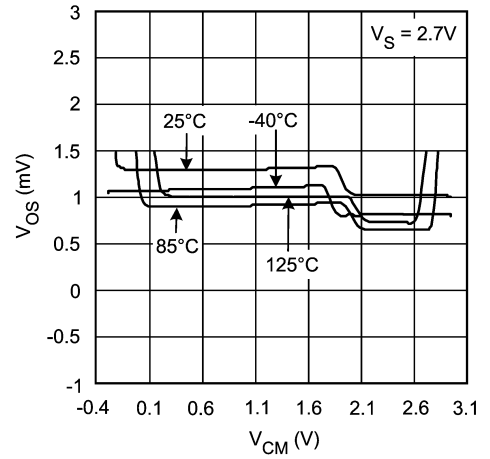

Offset Voltage vs. Common Mode Range

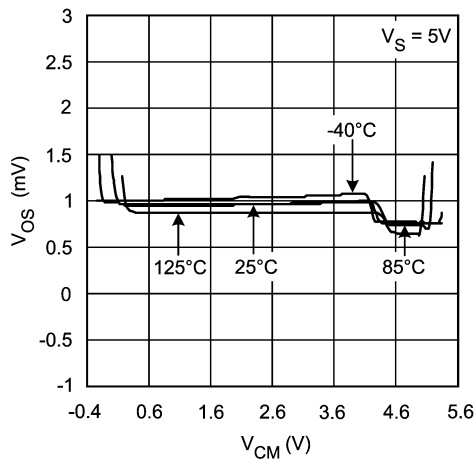

Application Note

1.0 INPUT AND OUTPUT STAGE

The rail-to-rail input stage of this family provides more flexibility for the designer. The LMV931/LMV932/LMV934 use a complimentary PNP and NPN input stage in which the PNP stage senses common mode voltage near V^- and the NPN stage senses common mode voltage near V^+ . The transition from the PNP stage to NPN stage occurs 1V below V^+ . Since both input stages have their own offset voltage, the offset of the amplifier becomes a function of the input common mode voltage and has a crossover point at 1V below V^+ .

This V_{OS} crossover point can create problems for both DC and AC coupled signals if proper care is not taken. Large input signals that include the V_{OS} crossover point will cause distortion in the output signal. One way to avoid such distortion is to keep the signal away from the crossover. For example, in a unity gain buffer configuration and with $V_S = 5V$, a 5V peak-to-peak signal will contain input-crossover distortion while a 3V peak-to-peak signal centered at 1.5V will not contain input-crossover distortion as it avoids the crossover point. Another way to avoid large signal distortion is to use a gain of -1 circuit which avoids any voltage excursions at the input terminals of the amplifier. In that circuit, the common mode DC voltage can be set at a level away from the V_{OS} cross-over point. For small signals, this transition in V_{OS} shows up as a V_{CM} dependent spurious signal in series with the input signal and can effectively degrade small signal parameters such as gain and common mode rejection ratio. To resolve this problem, the small signal should be placed such that it avoids the V_{OS} cross-over point. In addition to the rail-to-rail performance, the output stage can provide enough output current to drive 600Ω loads. Because of the high current capability, care should be taken not to exceed the 150°C maximum junction temperature specification.

2.0 INPUT BIAS CURRENT CONSIDERATION

The LMV931/LMV932/LMV934 family has a complementary bipolar input stage. The typical input bias current (I_B) is 15nA. The input bias current can develop a significant offset voltage. This offset is primarily due to I_B flowing through the negative feedback resistor, R_F . For example, if I_B is 50nA and R_F is 100kΩ, then an offset voltage of 5mV will develop ($V_{OS} = I_B \times R_F$). Using a compensation resistor (R_C), as shown in Figure 1, cancels this effect. But the input offset current (I_{OS}) will still contribute to an offset voltage in the same manner.

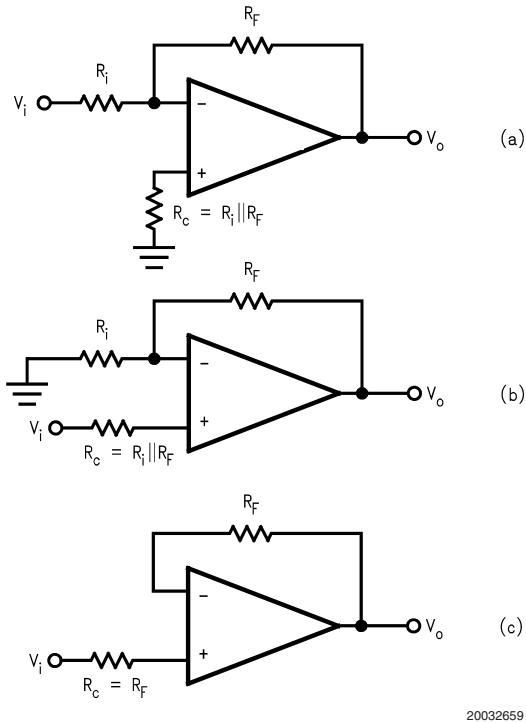

FIGURE 1. Canceling the Offset Voltage due to Input Bias Current

Typical Applications

3.0 HIGH SIDE CURRENT SENSING

The high side current sensing circuit (Figure 2) is commonly used in a battery charger to monitor charging current to prevent over charging. A sense resistor R_{SENSE} is connected to the battery directly. This system requires an op amp with rail-to-rail input. The LMV931/LMV932/LMV934 are ideal for this application because its common mode input range goes up to the rail.

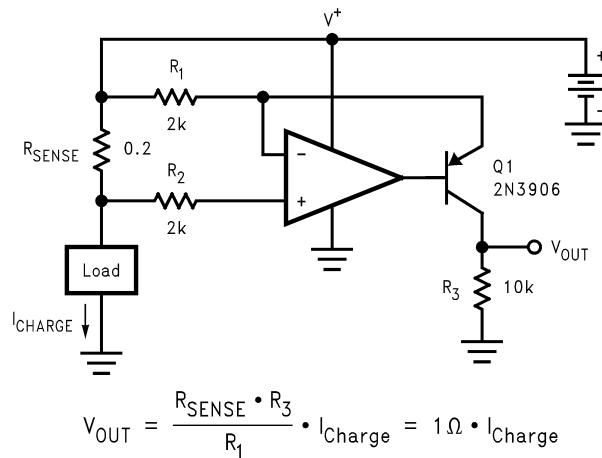

FIGURE 2. High Side Current Sensing

Typical Applications (Continued)

4.0 HALF-WAVE RECTIFIER WITH RAIL-TO-GROUND OUTPUT SWING

Since the LMV931/LMV932/LMV934 input common mode range includes both positive and negative supply rails and the output can also swing to either supply, achieving half-wave rectifier functions in either direction is an easy task. All that is needed are two external resistors; there is no need for diodes or matched resistors. The half wave rectifier can have either positive or negative going outputs, depending on the way the circuit is arranged.

In *Figure 3* the circuit is referenced to ground, while in *Figure 4* the circuit is biased to the positive supply. These configurations implement the half wave rectifier since the LMV931/LMV932/LMV934 can not respond to one-half of the incoming waveform. It can not respond to one-half of the incoming because the amplifier can not swing the output beyond either rail therefore the output disengages during this half cycle. During the other half cycle, however, the amplifier achieves a half wave that can have a peak equal to the total supply voltage. R_1 should be large enough not to load the LMV931/LMV932/LMV934.

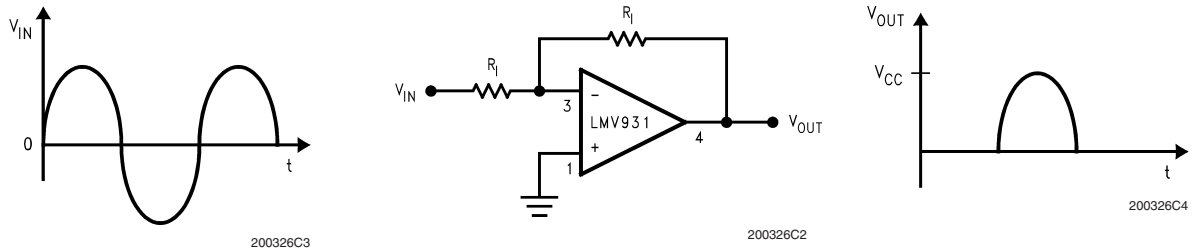

FIGURE 3. Half-Wave Rectifier with Rail-To-Ground Output Swing Referenced to Ground

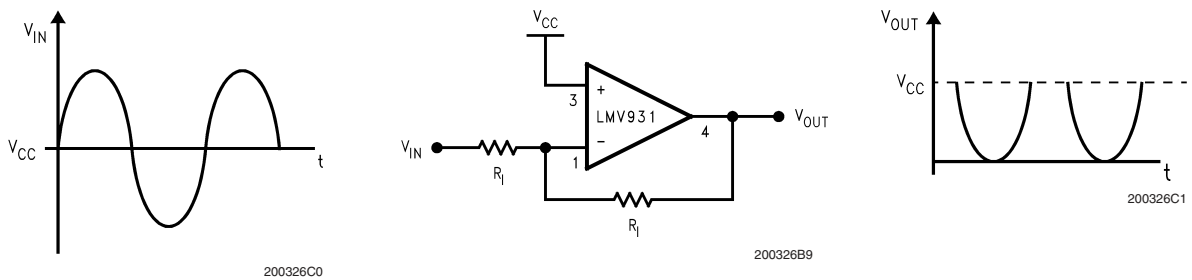

FIGURE 4. Half-Wave Rectifier with Negative-Going Output Referenced to V_{CC}

5.0 INSTRUMENTATION AMPLIFIER WITH RAIL-TO-RAIL INPUT AND OUTPUT

Some manufactures make a non-“rail-to-rail”-op amp rail-to-rail by using a resistive divider on the inputs. The resistors divide the input voltage to get a rail-to-rail input range. The problem with this method is that it also divides the signal, so in order to get the obtained gain, the amplifier must have a higher closed loop gain. This raises the noise and drift by the internal gain factor and lowers the input impedance. Any mismatch in these precision resistors reduces the CMRR as well. The LMV981/LMV982 is rail-to-rail and therefore doesn't have these disadvantages.

Using three of the LMV981/LMV982 amplifiers, an instrumentation amplifier with rail-to-rail inputs and outputs can be made as shown in *Figure 5*.

In this example, amplifiers on the left side act as buffers to the differential stage. These buffers assure that the input impedance is very high and require no precision matched resistors in the input stage. They also assure that the difference amp is driven from a voltage source. This is necessary to maintain the CMRR set by the matching R_1 - R_2 with R_3 - R_4 . The gain is set by the ratio of R_2/R_1 and R_3 should equal R_1 and R_4 equal R_2 . With both rail-to-rail input and output ranges, the input and output are only limited by the supply

voltages. Remember that even with rail-to-rail outputs, the output can not swing past the supplies so the combined common mode voltages plus the signal should not be greater than the supplies or limiting will occur. For additional applications, see National Semiconductor application notes AN-29, AN-31, AN-71, and AN-127.

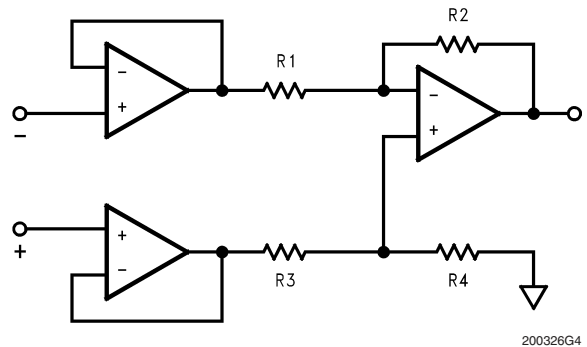
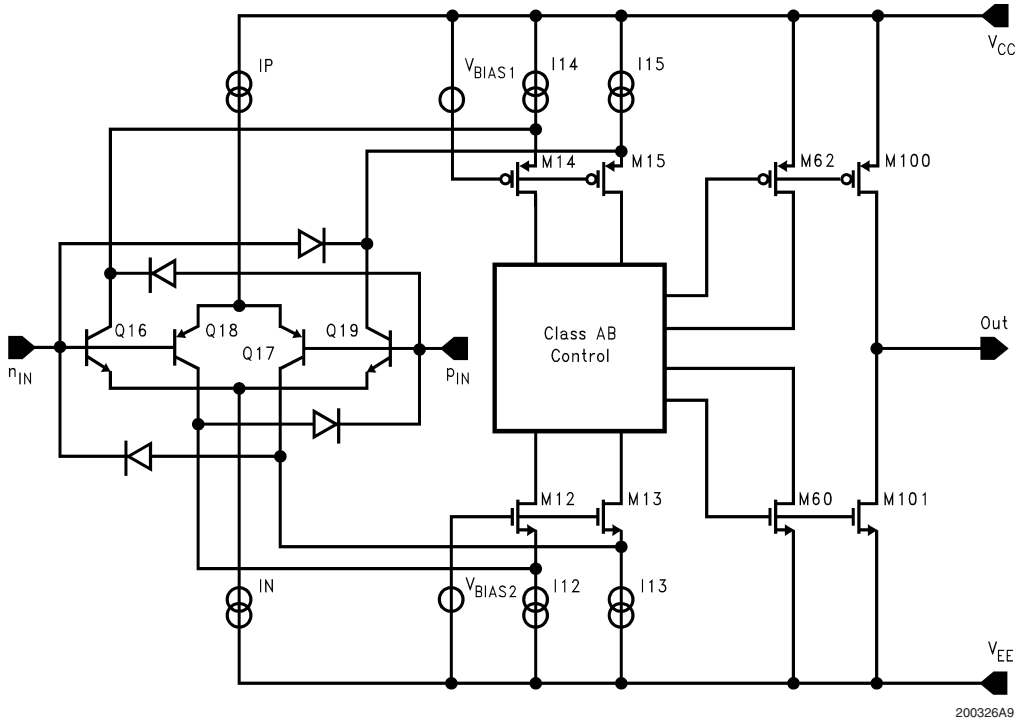

FIGURE 5. Rail-to-rail Instrumentation Amplifier

Simplified Schematic



Physical Dimensions inches (millimeters)

unless otherwise noted

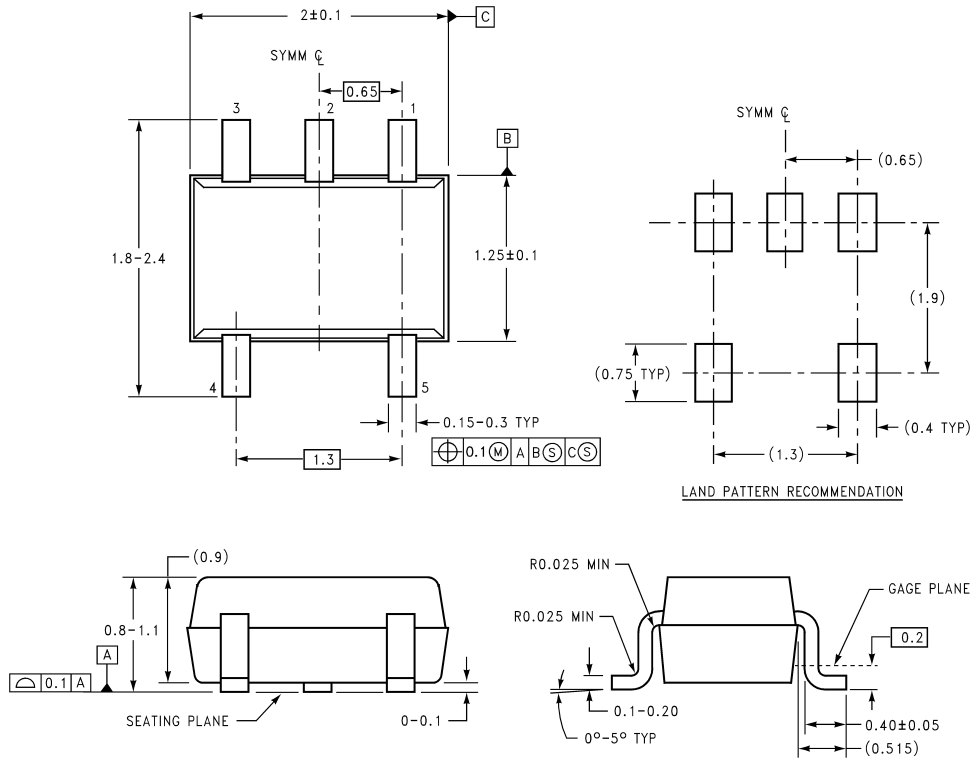

DIMENSIONS ARE IN MILLIMETERS

MAA05A (REV B)

5-Pin SC70
NS Package Number MAA05A

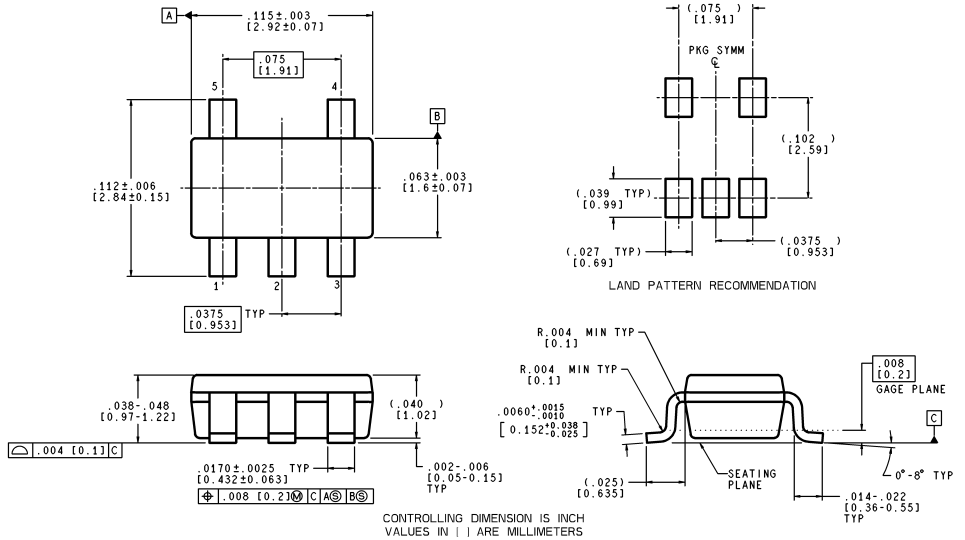

CONTROLLING DIMENSION IS INCH
VALUES IN [] ARE MILLIMETERS

MF05A (Rev A)

5-Pin SOT23
NS Package Number MF05A

Physical Dimensions inches (millimeters) unless otherwise noted (Continued)

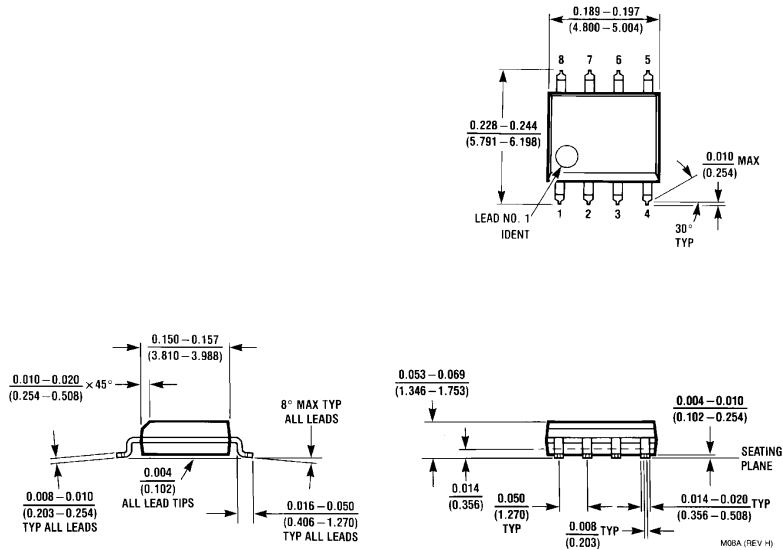
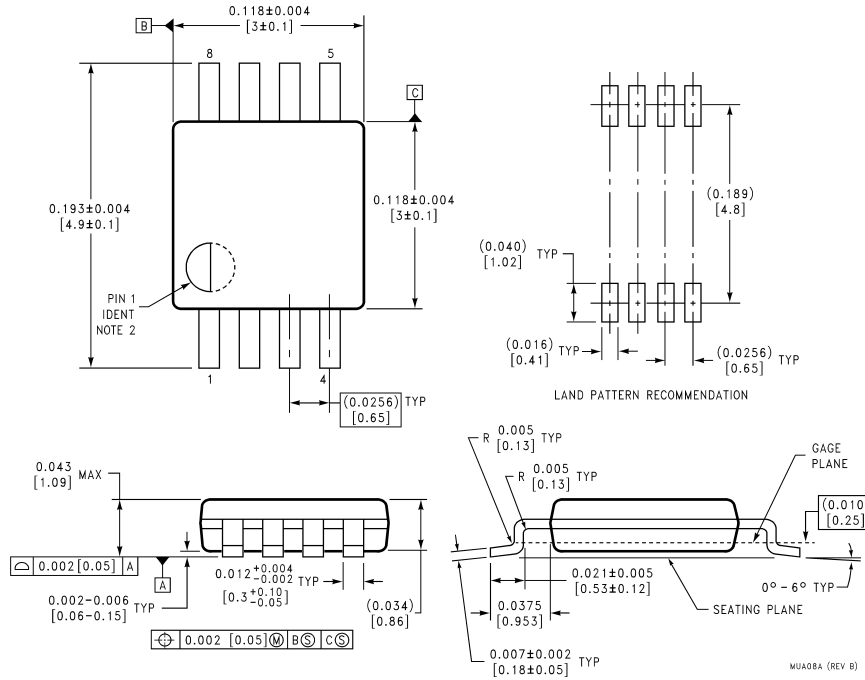

Physical Dimensions inches (millimeters) unless otherwise noted (Continued)

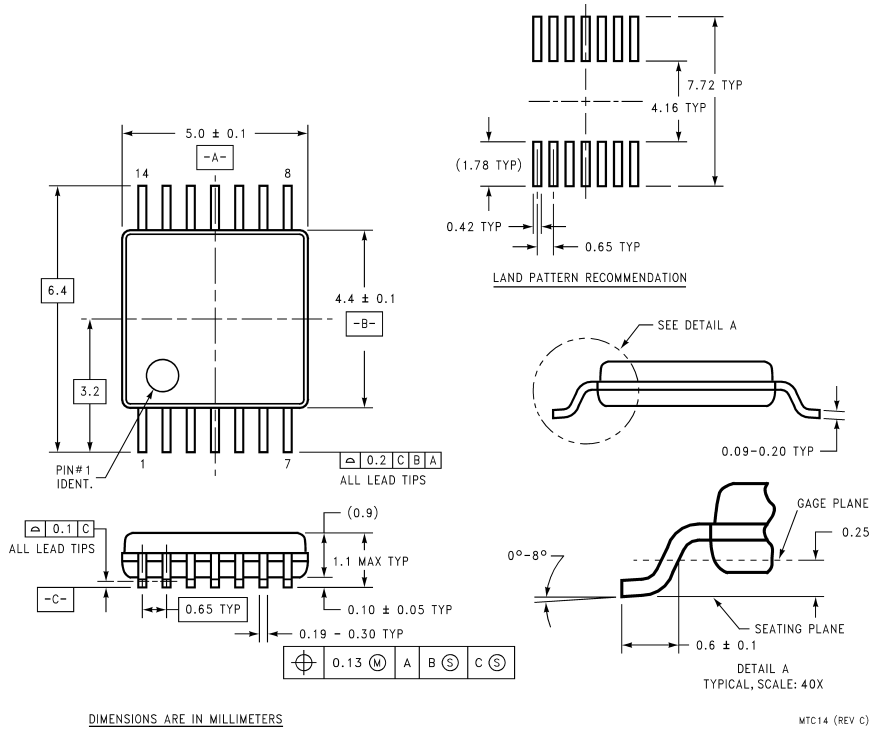

14-Pin TSSOP
NS Package Number MTC14

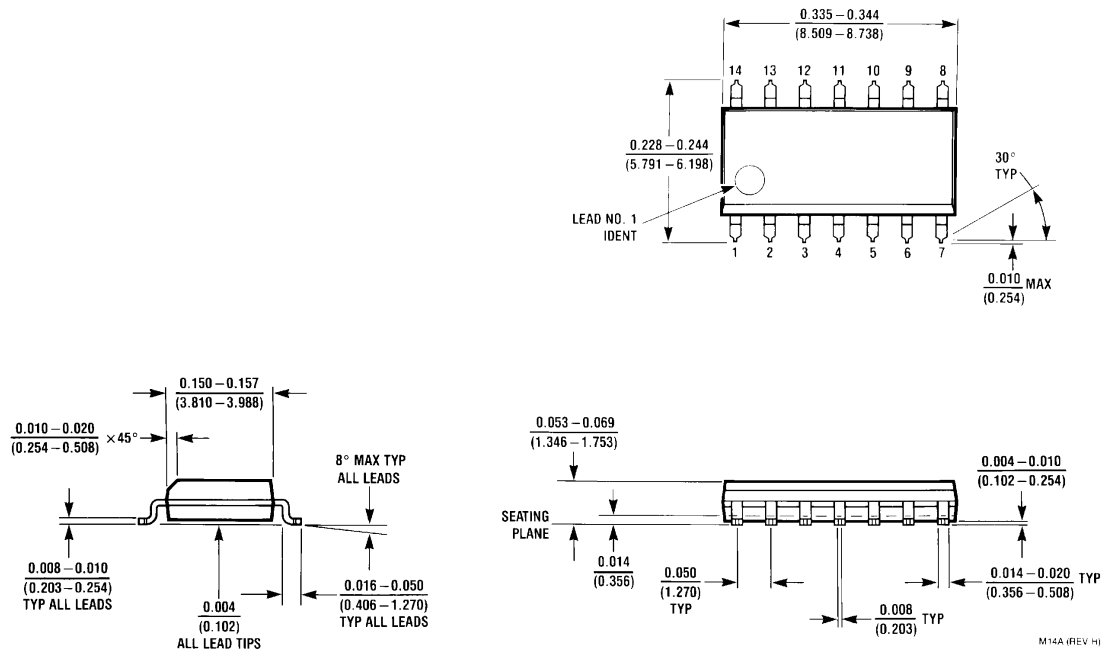

14-Pin SOIC
NS Package Number M14A

Notes

LIFE SUPPORT POLICY

NATIONAL'S PRODUCTS ARE NOT AUTHORIZED FOR USE AS CRITICAL COMPONENTS IN LIFE SUPPORT DEVICES OR SYSTEMS WITHOUT THE EXPRESS WRITTEN APPROVAL OF THE PRESIDENT AND GENERAL COUNSEL OF NATIONAL SEMICONDUCTOR CORPORATION. As used herein:

1. Life support devices or systems are devices or systems which, (a) are intended for surgical implant into the body, or (b) support or sustain life, and whose failure to perform when properly used in accordance with instructions for use provided in the labeling, can be reasonably expected to result in a significant injury to the user.
2. A critical component is any component of a life support device or system whose failure to perform can be reasonably expected to cause the failure of the life support device or system, or to affect its safety or effectiveness.



National Semiconductor Corporation
Americas
Email: support@nsc.com

www.national.com

National Semiconductor Europe

Fax: +49 (0) 180-530 85 86
Email: europe.support@nsc.com
Deutsch Tel: +49 (0) 69 9508 6208
English Tel: +44 (0) 870 24 0 2171
Français Tel: +33 (0) 1 41 91 8790

National Semiconductor Asia Pacific Customer Response Group

Tel: 65-2544466
Fax: 65-2504466
Email: ap.support@nsc.com

National Semiconductor Japan Ltd.

Tel: 81-3-5639-7560
Fax: 81-3-5639-7507