

# LMV1012 Analog Series: Pre-Amplified IC's for High Gain 2-Wire Microphones

## General Description

The LMV1012 is an audio amplifier series for small form factor electret microphones. This 2-wire portfolio is designed to replace the JFET amplifier currently being used. The LMV1012 series is ideally suited for applications requiring high signal integrity in the presence of ambient or RF noise, such as in cellular communications. The LMV1012 audio amplifiers are guaranteed to operate over a 2.2V to 5.0V supply voltage range with fixed gains of 7.8 dB, 15.6 dB, 20.9 dB, and 23.8 dB. The devices offer excellent THD, gain accuracy and temperature stability as compared to a JFET microphone.

The LMV1012 series enables a two-pin electret microphone solution, which provides direct pin-to-pin compatibility with the existing JFET market.

The devices are offered in extremely thin space saving 4-bump micro SMD packages. The LMV1012XP is designed for 1.0 mm canisters and thicker ECM canisters. These extremely miniature packages are designed for electret condenser microphones (ECM) form factor.

## Features

(Typical LMV1012-15, 2.2V supply,  $R_L = 2.2\text{ k}\Omega$ ,  $C = 2.2\text{ }\mu\text{F}$ ,  $V_{IN} = 18\text{ mV}_{PP}$ , unless otherwise specified)

|  |                    |
|--|--------------------|
| ■ Supply voltage                       | 2V - 5V            |
| ■ Supply current                       | <180 $\mu\text{A}$ |
| ■ Signal to noise ratio (A-weighted)   | 60 dB              |
| ■ Output voltage noise (A-weighted)    | -89 dBV            |
| ■ Total harmonic distortion            | 0.09%              |
| ■ Voltage gain                         |                    |
| — LMV1012-07                           | 7.8 dB             |
| — LMV1012-15                           | 15.6 dB            |
| — LMV1012-20                           | 20.9 dB            |
| — LMV1012-25                           | 23.8 dB            |
| ■ Temperature range                    | -40°C to 85°C      |
| ■ Offered in 4-bump micro SMD packages |                    |

## Applications

- Cellular phones
- Headsets
- Mobile communications
- Automotive accessories
- PDAs
- Accessory microphone products

## Schematic Diagram

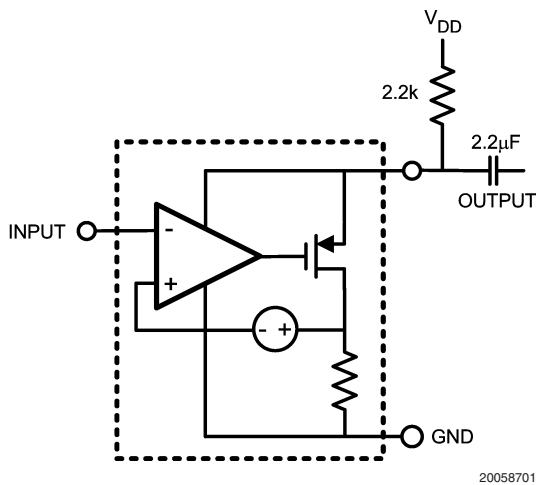

## Built-In Gain Electret Microphone

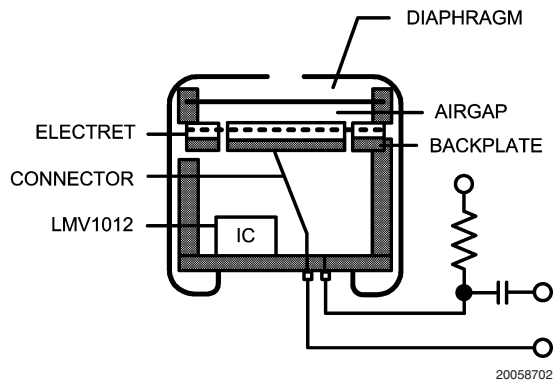

### Absolute Maximum Ratings (Note 1)

If Military/Aerospace specified devices are required, please contact the National Semiconductor Sales Office/Distributors for availability and specifications.

|                        |       |
|------------------------|-------|
| ESD Tolerance (Note 2) |       |
| Human Body Model       | 2500V |
| Machine Model          | 250V  |
| Supply Voltage         |       |
| V <sub>DD</sub> - GND  | 5.5V  |

|                                  |                |
|----------------------------------|----------------|
| Storage Temperature Range        | -65°C to 150°C |
| Junction Temperature (Note 6)    | 150°C max      |
| Mounting Temperature             |                |
| Infrared or Convection (20 sec.) | 235°C          |

### Operating Ratings (Note 1)

|                   |               |
|-------------------|---------------|
| Supply Voltage    | 2V to 5V      |
| Temperature Range | -40°C to 85°C |

### 2.2V Electrical Characteristics (Note 3)

Unless otherwise specified, all limits guaranteed for T<sub>J</sub> = 25°C, V<sub>DD</sub> = 2.2V, V<sub>IN</sub> = 18 mV, R<sub>L</sub> = 2.2 kΩ and C = 2.2 μF. **Boldface** limits apply at the temperature extremes.

| Symbol            | Parameter                     | Conditions                                     | Min (Note 4) | Typ (Note 5) | Max (Note 4) | Units            |   |
|-------------------|-------------------------------|--|--------------|--------------|--------------|------------------|---|
| I <sub>DD</sub>   | Supply Current                | V <sub>IN</sub> = GND                          | LMV1012-07   |              | 250          | μA               |   |
|                   |                               |  |              |              | <b>300</b>   |                  |   |
|                   |                               |  | LMV1012-15   |              | 300          |                  |   |
|                   |                               |  |              |              | <b>325</b>   |                  |   |
|                   |                               |  | LMV1012-20   |              | 250          |                  |   |
|                   |                               |  |              |              | <b>300</b>   |                  |   |
|                   |                               |  | LMV1012-25   |              | 250          |                  |   |
|                   |                               |  |              |              | <b>300</b>   |                  |   |
| SNR               | Signal to Noise Ratio         | f = 1 kHz, V <sub>IN</sub> = 18 mV, A-Weighted | LMV1012-07   |              | 59           | dB               |   |
|                   |                               |  |              |              | 60           |                  |   |
|                   |                               |  | LMV1012-20   |              | 61           |                  |   |
|                   |                               |  |              |              | 61           |                  |   |
| V <sub>IN</sub>   | Max Input Signal              | f = 1 kHz and THD+N < 1%                       | LMV1012-07   |              | 170          | mV <sub>PP</sub> |   |
|                   |                               |  |              |              | 100          |                  |   |
|                   |                               |  | LMV1012-20   |              | 50           |                  |   |
|                   |                               |  |              |              | 28           |                  |   |
| V <sub>OUT</sub>  | Output Voltage                | V <sub>IN</sub> = GND                          | LMV1012-07   | 1.65         | 1.90         | 2.03             | V |
|                   |                               |  |              | <b>1.54</b>  |              | <b>2.09</b>      |   |
|                   |                               |  | LMV1012-15   | 1.54         | 1.81         | 1.94             |   |
|                   |                               |  |              | <b>1.48</b>  |              | <b>2.00</b>      |   |
|                   |                               |  | LMV1012-20   | 1.65         | 1.85         | 2.03             |   |
|                   |                               |  |              | <b>1.55</b>  |              | <b>2.13</b>      |   |
|                   |                               |  | LMV1012-25   | 1.65         | 1.90         | 2.02             |   |
|                   |                               |  |              | <b>1.49</b>  |              | <b>2.18</b>      |   |
| f <sub>LOW</sub>  | Lower -3dB Roll Off Frequency | R <sub>SOURCE</sub> = 50Ω                      |              | 65           |              | Hz               |   |
| f <sub>HIGH</sub> | Upper -3dB Roll Off Frequency | R <sub>SOURCE</sub> = 50Ω                      |              | 95           |              | kHz              |   |
| e <sub>n</sub>    | Output Noise                  | A-Weighted                                     | LMV1012-07   |              | -96          | dBV              |   |
|                   |                               |  |              |              | -89          |                  |   |
|                   |                               |  | LMV1012-20   |              | -84          |                  |   |
|                   |                               |  |              |              | -82          |                  |   |
| THD               | Total Harmonic Distortion     | f = 1 kHz, V <sub>IN</sub> = 18 mV             | LMV1012-07   |              | 0.10         | %                |   |
|                   |                               |  |              |              | 0.09         |                  |   |
|                   |                               |  | LMV1012-20   |              | 0.12         |                  |   |
|                   |                               |  |              |              | 0.15         |                  |   |
| C <sub>IN</sub>   | Input Capacitance             |  |              | 2            |              | pF               |   |
| Z <sub>IN</sub>   | Input Impedance               |  |              | >1000        |              | GΩ               |   |

## 2.2V Electrical Characteristics (Note 3) (Continued)

Unless otherwise specified, all limits guaranteed for  $T_J = 25^\circ\text{C}$ ,  $V_{DD} = 2.2\text{V}$ ,  $V_{IN} = 18\text{ mV}$ ,  $R_L = 2.2\text{ k}\Omega$  and  $C = 2.2\text{ }\mu\text{F}$ .

**Boldface** limits apply at the temperature extremes.

| Symbol | Parameter | Conditions                                      | Min<br>(Note 4) | Typ<br>(Note 5) | Max<br>(Note 4) | Units       |    |
|--------|-----------|---|-----------------|-----------------|-----------------|-------------|----|
| $A_V$  | Gain      | $f = 1\text{ kHz}$ ,<br>$R_{SOURCE} = 50\Omega$ | LMV1012-07      | 6.4             | 7.8             | 9.5         | dB |
|        |           |   |                 | <b>5.5</b>      |                 | <b>10.0</b> |    |
|        |           |   | LMV1012-15      | 14.0            | 15.6            | 16.9        |    |
|        |           |   |                 | <b>13.1</b>     |                 | <b>17.5</b> |    |
|        |           |   | LMV1012-20      | 19.5            | 20.9            | 22.0        |    |
|        |           |   |                 | <b>17.4</b>     |                 | <b>23.3</b> |    |
|        |           |   | LMV1012-25      | 22.5            | 23.8            | 25.0        |    |
|        |           |   |                 | <b>21.4</b>     |                 | <b>25.7</b> |    |

## 5V Electrical Characteristics (Note 3)

Unless otherwise specified, all limits guaranteed for  $T_J = 25^\circ\text{C}$ ,  $V_{DD} = 5\text{V}$ ,  $V_{IN} = 18\text{ mV}$ ,  $R_L = 2.2\text{ k}\Omega$  and  $C = 2.2\text{ }\mu\text{F}$ .

**Boldface** limits apply at the temperature extremes.

| Symbol     | Parameter                     | Conditions  | Min<br>(Note 4) | Typ<br>(Note 5) | Max<br>(Note 4) | Units       |                  |
|------------|-------------------------------|---|-----------------|-----------------|-----------------|-------------|------------------|
| $I_{DD}$   | Supply Current                | $V_{IN} = \text{GND}$                                     | LMV1012-07      |                 | 158             | 250         | $\mu\text{A}$    |
|            |                               |   |                 |                 |                 | <b>300</b>  |                  |
|            |                               |   | LMV1012-15      |                 | 200             | 300         |                  |
|            |                               |   |                 |                 |                 | <b>325</b>  |                  |
|            |                               |   | LMV1012-20      |                 | 188             | 260         |                  |
|            |                               |   |                 |                 |                 | <b>310</b>  |                  |
|            |                               |   | LMV1012-25      |                 | 160             | 250         |                  |
|            |                               |   |                 |                 |                 | <b>300</b>  |                  |
| SNR        | Signal to Noise Ratio         | $f = 1\text{ kHz}$ , $V_{IN} = 18\text{ mV}$ , A-Weighted | LMV1012-07      |                 | 59              |             | dB               |
|            |                               |   |                 |                 |                 | 60          |                  |
|            |                               |   | LMV1012-15      |                 |                 | 61          |                  |
|            |                               |   |                 |                 |                 | 61          |                  |
|            |                               |   | LMV1012-20      |                 |                 |             |                  |
|            |                               |   |                 |                 |                 |             |                  |
| $V_{IN}$   | Max Input Signal              | $f = 1\text{ kHz}$ and<br>THD+N < 1%                      | LMV1012-07      |                 | 170             |             | $\text{mV}_{PP}$ |
|            |                               |   |                 |                 |                 | 100         |                  |
|            |                               |   | LMV1012-15      |                 |                 | 55          |                  |
|            |                               |   |                 |                 |                 | 28          |                  |
|            |                               |   | LMV1012-20      |                 |                 |             |                  |
|            |                               |   |                 |                 |                 |             |                  |
| $V_{OUT}$  | Output Voltage                | $V_{IN} = \text{GND}$                                     | LMV1012-07      | 4.45            | 4.65            | 4.80        | V                |
|            |                               |   |                 | <b>4.38</b>     |                 | <b>4.85</b> |                  |
|            |                               |   | LMV1012-15      | 4.34            | 4.56            | 4.74        |                  |
|            |                               |   |                 | <b>4.28</b>     |                 | <b>4.80</b> |                  |
|            |                               |   | LMV1012-20      | 4.40            | 4.58            | 4.75        |                  |
|            |                               |   |                 | <b>4.30</b>     |                 | <b>4.85</b> |                  |
|            |                               |   | LMV1012-25      | 4.45            | 4.65            | 4.83        |                  |
|            |                               |   |                 | <b>4.39</b>     |                 | <b>4.86</b> |                  |
| $f_{LOW}$  | Lower -3dB Roll Off Frequency | $R_{SOURCE} = 50\Omega$                                   |                 | 67              |                 | Hz          |                  |
| $f_{HIGH}$ | Upper -3dB Roll Off Frequency | $R_{SOURCE} = 50\Omega$                                   |                 | 150             |                 | kHz         |                  |
| $e_n$      | Output Noise                  | A-Weighted  | LMV1012-07      |                 | -96             |             | dBV              |
|            |                               |   |                 |                 |                 | -89         |                  |
|            |                               |   | LMV1012-15      |                 |                 | -84         |                  |
|            |                               |   |                 |                 |                 | -82         |                  |
|            |                               |   | LMV1012-20      |                 |                 |             |                  |
|            |                               |   |                 |                 |                 |             |                  |
| THD        | Total Harmonic Distortion     | $f = 1\text{ kHz}$ ,<br>$V_{IN} = 18\text{ mV}$           | LMV1012-07      |                 | 0.12            |             | %                |
|            |                               |   |                 |                 |                 | 0.13        |                  |
|            |                               |   | LMV1012-15      |                 |                 | 0.18        |                  |
|            |                               |   |                 |                 |                 | 0.21        |                  |
|            |                               |   | LMV1012-20      |                 |                 |             |                  |
|            |                               |   |                 |                 |                 |             |                  |
|            |                               |   | LMV1012-25      |                 |                 |             |                  |
|            |                               |   |                 |                 |                 |             |                  |

**5V Electrical Characteristics** (Note 3) (Continued)

Unless otherwise specified, all limits guaranteed for  $T_J = 25^\circ\text{C}$ ,  $V_{DD} = 5\text{V}$ ,  $V_{IN} = 18\text{ mV}$ ,  $R_L = 2.2\text{ k}\Omega$  and  $C = 2.2\text{ }\mu\text{F}$ .

**Boldface** limits apply at the temperature extremes.

| Symbol   | Parameter         | Conditions                                      | Min<br>(Note 4) | Typ<br>(Note 5)     | Max<br>(Note 4) | Units               |    |
|----------|-------------------|---|-----------------|---------------------|-----------------|---------------------|----|
| $C_{IN}$ | Input Capacitance |   |                 | 2                   |                 | pF                  |    |
| $Z_{IN}$ | Input Impedance   |   |                 | >1000               |                 | G $\Omega$          |    |
| $A_V$    | Gain              | $f = 1\text{ kHz}$ ,<br>$R_{SOURCE} = 50\Omega$ | LMV1012-07      | 6.4<br><b>5.5</b>   | 8.1             | 9.5<br><b>10.7</b>  | dB |
|          |                   |   | LMV1012-15      | 14.0<br><b>13.1</b> | 15.6            | 16.9<br><b>17.5</b> |    |
|          |                   |   | LMV1012-20      | 19.2<br><b>17.0</b> | 21.1            | 22.3<br><b>23.5</b> |    |
|          |                   |   | LMV1012-25      | 22.5<br><b>21.2</b> | 23.9            | 25.0<br><b>25.8</b> |    |

**Note 1:** Absolute Maximum Ratings indicate limits beyond which damage to the device may occur. Operating Ratings indicate conditions for which the device is intended to be functional, but specific performance is not guaranteed. For guaranteed specifications and the test conditions, see the Electrical Characteristics.

**Note 2:** Human Body Model (HBM) is 1.5 k $\Omega$  in series with 100 pF.

**Note 3:** Electrical Table values apply only for factory testing conditions at the temperature indicated. Factory testing conditions result in very limited self-heating of the device such that  $T_J = T_A$ . No guarantee of parametric performance is indicated in the electrical tables under conditions of internal self-heating where  $T_J > T_A$ .

**Note 4:** All limits are guaranteed by design or statistical analysis.

**Note 5:** Typical values represent the most likely parametric norm.

**Note 6:** The maximum power dissipation is a function of  $T_{J(MAX)}$ ,  $\theta_{JA}$  and  $T_A$ . The maximum allowable power dissipation at any ambient temperature is  $P_D = (T_{J(MAX)} - T_A)/\theta_{JA}$ . All numbers apply for packages soldered directly into a PC board.

## Connection Diagram

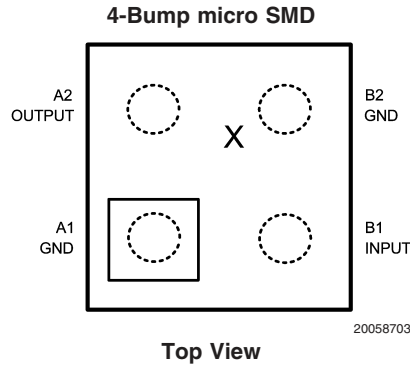

**Note:** - Pin numbers are referenced to package marking text orientation.  
 - The actual physical placement of the package marking will vary slightly from part to part. The package will designate the date code and will vary considerably. Package marking does not correlate to device type in any way.

## Ordering Information

| Package  | Part Number   | Package Marking | Transport Media         | NSC Drawing |
|--|---------------|-----------------|-------------------------|-------------|
| 4-Bump Extreme Thin micro SMD<br>(0.3 mm max height)<br>lead free only | LMV1012XP-15  | Date Code       | 250 Units Tape and Reel | XPA04HLA    |
|  | LMV1012XPX-15 |                 | 3k Units Tape and Reel  |             |
|  | LMV1012XP-25  |                 | 250 Units Tape and Reel |             |
|  | LMV1012XPX-25 |                 | 3k Units Tape and Reel  |             |
| 4-Bump Ultra-Thin micro SMD<br>(0.4 mm max height)<br>lead free only   | LMV1012UP-07  | Date Code       | 250 Units Tape and Reel | UPA04GKA    |
|  | LMV1012UPX-07 |                 | 3k Units Tape and Reel  |             |
|  | LMV1012UP-15  |                 | 250 Units Tape and Reel |             |
|  | LMV1012UPX-15 |                 | 3k Units Tape and Reel  |             |
|  | LMV1012UP-20  |                 | 250 Units Tape and Reel |             |
|  | LMV1012UPX-20 |                 | 3k Units Tape and Reel  |             |
|  | LMV1012UP-25  |                 | 250 Units Tape and Reel |             |
|  | LMV1012UPX-25 |                 | 3k Units Tape and Reel  |             |
| 4-Bump Thin micro SMD<br>(0.5 mm max height)                           | LMV1012TP-07  | Date Code       | 250 Units Tape and Reel | TPA04GKA    |
|  | LMV1012TPX-07 |                 | 3k Units Tape and Reel  |             |
|  | LMV1012TP-15  |                 | 250 Units Tape and Reel |             |
|  | LMV1012TPX-15 |                 | 3k Units Tape and Reel  |             |
|  | LMV1012TP-25  |                 | 250 Units Tape and Reel |             |
|  | LMV1012TPX-25 |                 | 3k Units Tape and Reel  |             |

**Typical Performance Characteristics**

Unless otherwise specified,  $V_S = 2.2V$ ,  $R_L = 2.2 k\Omega$ ,

$C = 2.2 \mu F$ , single supply,  $T_A = 25^\circ C$

**Supply Current vs. Supply Voltage (LMV1012-07)**

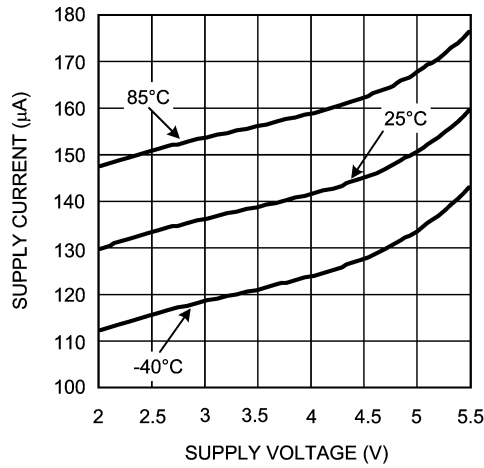

20058718

**Supply Current vs. Supply Voltage (LMV1012-15)**

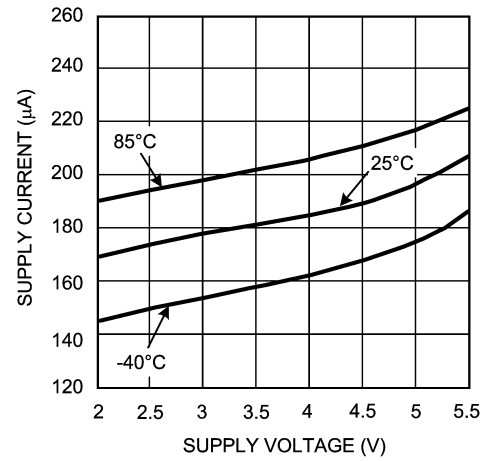

20058704

**Supply Current vs. Supply Voltage (LMV1012-20)**

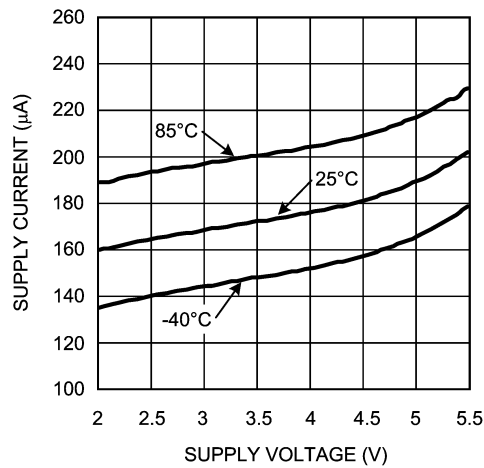

20058724

**Supply Current vs. Supply Voltage (LMV1012-25)**

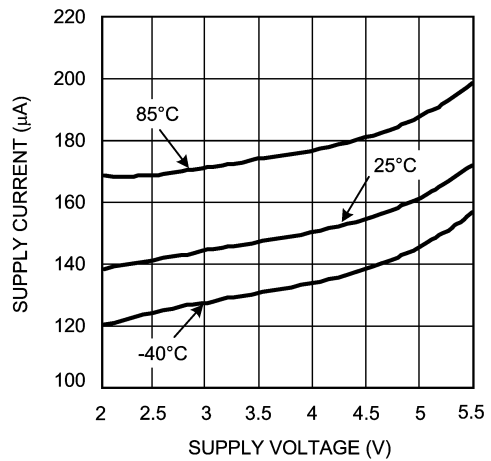

20058719

**Gain and Phase vs. Frequency (LMV1012-07)**

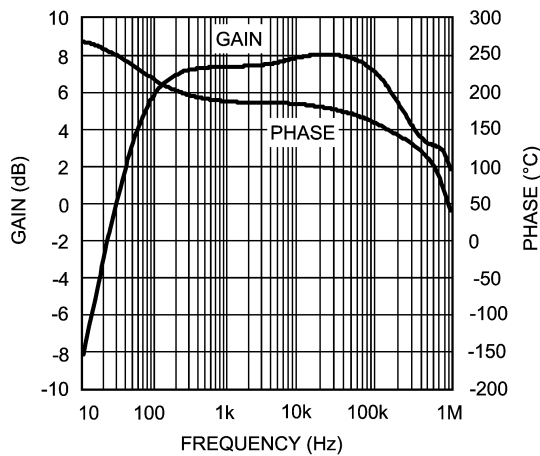

20058714

**Gain and Phase vs. Frequency (LMV1012-15)**

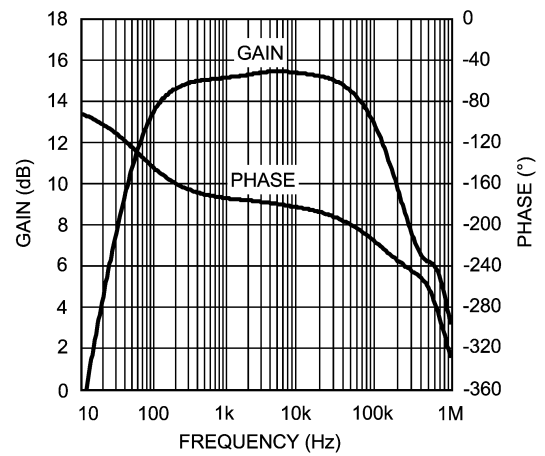

20058705

## Typical Performance Characteristics Unless otherwise specified, $V_S = 2.2V$ , $R_L = 2.2 k\Omega$ ,

$C = 2.2 \mu F$ , single supply,  $T_A = 25^\circ C$  (Continued)

**Gain and Phase vs. Frequency (LMV1012-20)**

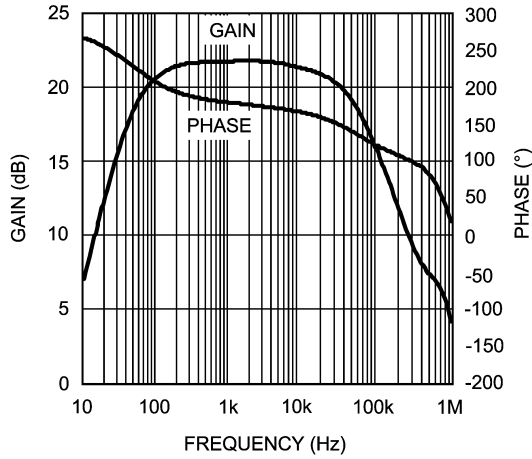

20058725

**Gain and Phase vs. Frequency (LMV1012-25)**

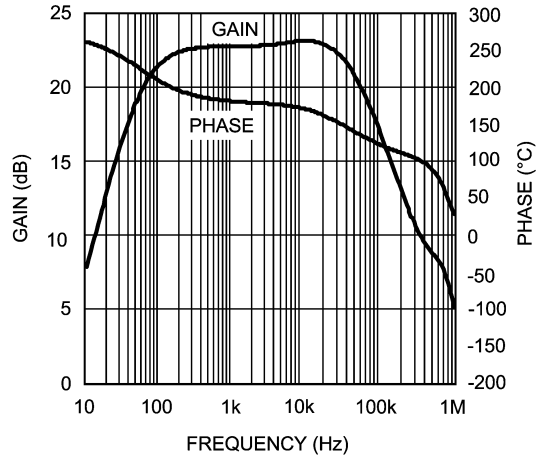

20058713

**Total Harmonic Distortion vs. Frequency (LMV1012-07)**

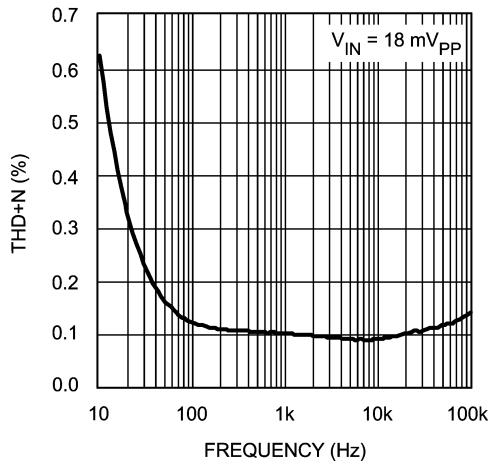

20058720

**Total Harmonic Distortion vs. Frequency (LMV1012-15)**

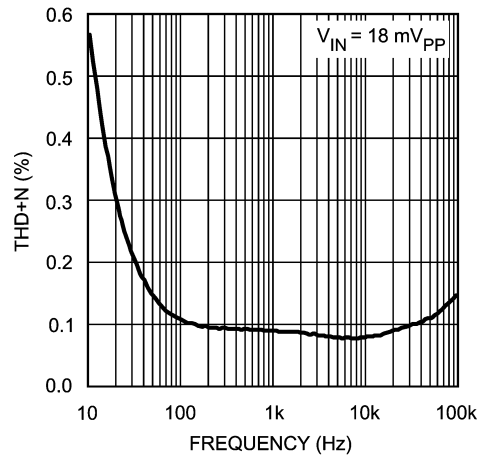

20058706

**Total Harmonic Distortion vs. Frequency (LMV1012-20)**

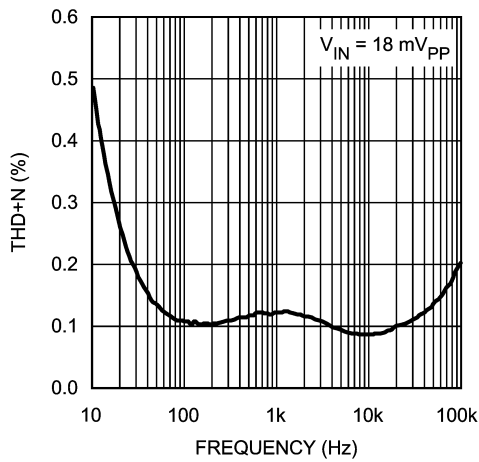

20058726

**Total Harmonic Distortion vs. Frequency (LMV1012-25)**

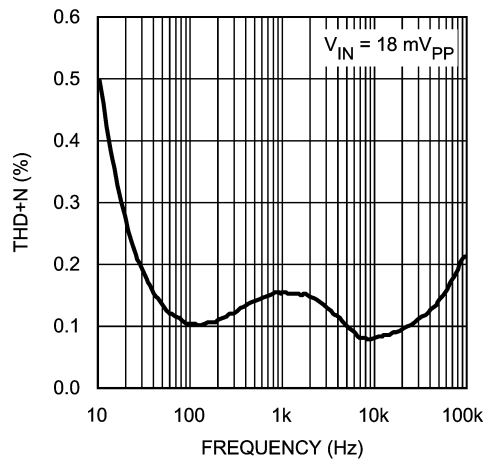

20058721

**Typical Performance Characteristics** Unless otherwise specified,  $V_S = 2.2V$ ,  $R_L = 2.2 k\Omega$ ,  $C = 2.2 \mu F$ , single supply,  $T_A = 25^\circ C$  (Continued)

**Total Harmonic Distortion vs. Input Voltage (LMV1012-07)**

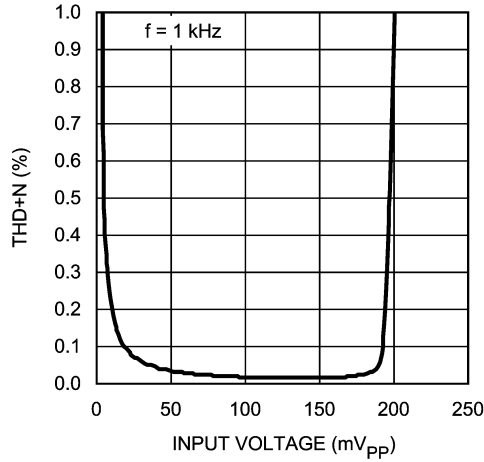

20058722

**Total Harmonic Distortion vs. Input Voltage (LMV1012-15)**

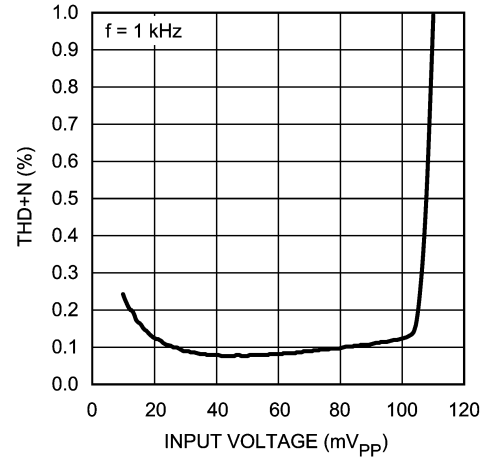

20058707

**Total Harmonic Distortion vs. Input Voltage (LMV1012-20)**

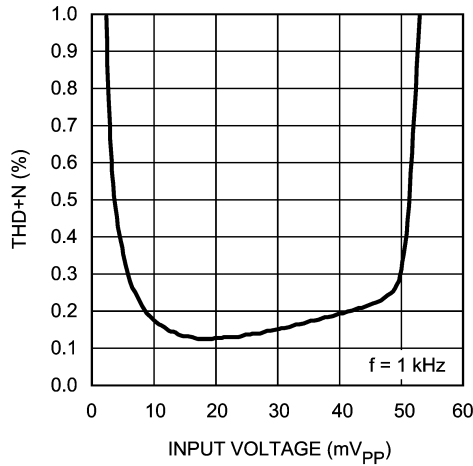

20058727

**Total Harmonic Distortion vs. Input Voltage (LMV1012-25)**

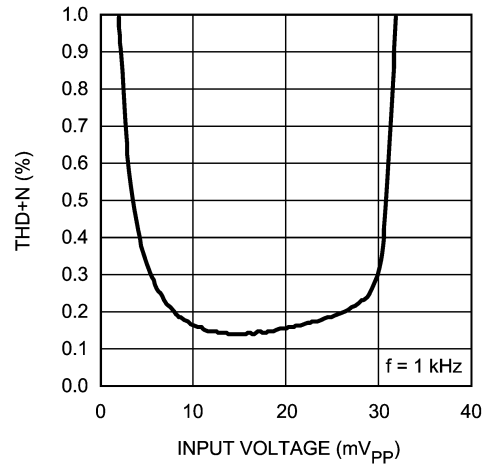

20058723

**Output Noise vs. Frequency (LMV1012-07)**

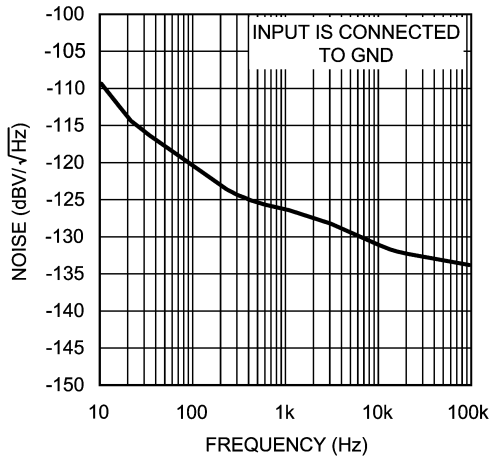

20058717

**Output Noise vs. Frequency (LMV1012-15)**

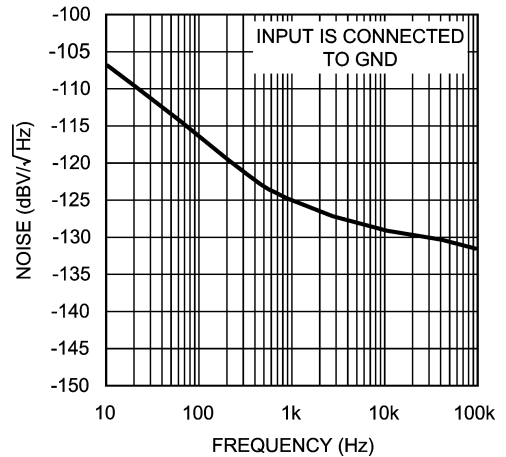

20058715



**Typical Performance Characteristics** Unless otherwise specified,  $V_S = 2.2V$ ,  $R_L = 2.2 k\Omega$ ,  $C = 2.2 \mu F$ , single supply,  $T_A = 25^\circ C$  (Continued)

**Output Noise vs. Frequency (LMV1012-20)**

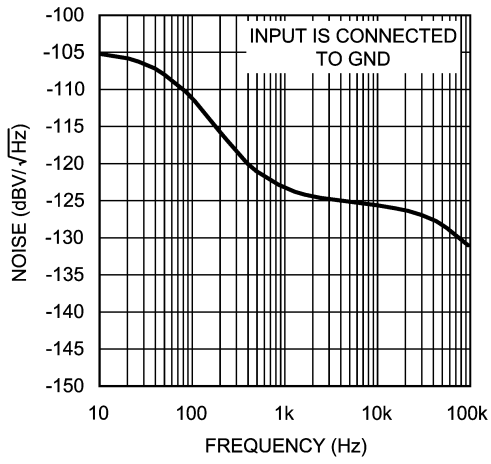

**Output Noise vs. Frequency (LMV1012-25)**

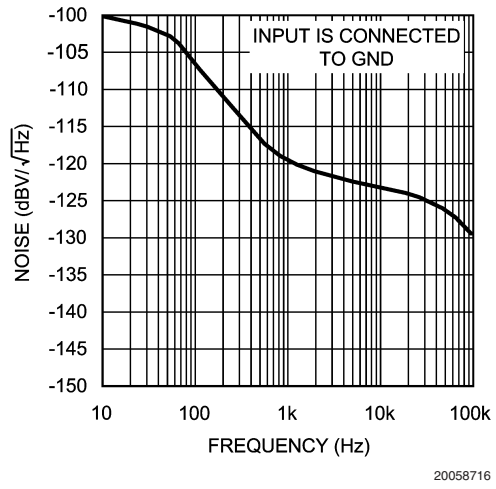

## Application Section

### HIGH GAIN

The LMV1012 series provides outstanding gain versus the JFET and still maintains the same ease of implementation, with improved gain, linearity and temperature stability. A high gain eliminates the need for extra external components.

### BUILT IN GAIN

The LMV1012 is offered in 0.3 mm height space saving small 4-pin micro SMD packages in order to fit inside the different size ECM canisters of a microphone. The LMV1012 is placed on the PCB inside the microphone.

The bottom side of the PCB usually shows a bull's eye pattern where the outer ring, which is shorted to the metal can, should be connected to the ground. The center dot on the PCB is connected to the  $V_{DD}$  through a resistor. This phantom biasing allows both supply voltage and output signal on one connection.

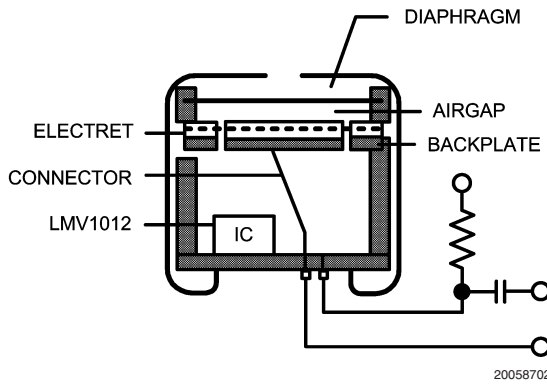
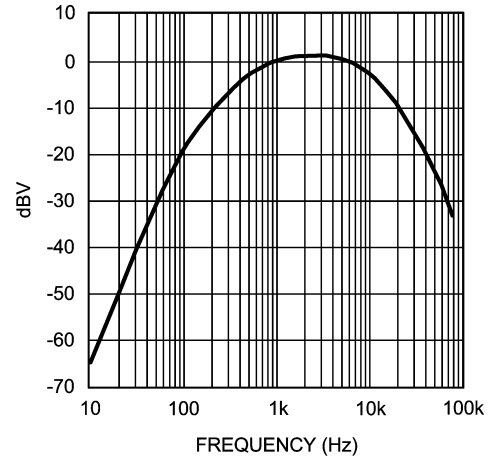

FIGURE 1. Built in Gain

### A-WEIGHTED FILTER

The human ear has a frequency range from 20 Hz to about 20 kHz. Within this range the sensitivity of the human ear is not equal for each frequency. To approach the hearing response weighting filters are introduced. One of those filters is the A-weighted filter.

The A-weighted filter is usually used in signal to noise ratio measurements, where sound is compared to device noise. This filter improves the correlation of the measured data to the signal to noise ratio perceived by the human ear.



20058709

FIGURE 2. A-Weighted Filter

### MEASURING NOISE AND SNR

The overall noise of the LMV1012 is measured within the frequency band from 10 Hz to 22 kHz using an A-weighted filter. The input of the LMV1012 is connected to ground with a 5 pF capacitor, as in Figure 3. Special precautions in the internal structure of the LMV1012 have been taken to reduce the noise on the output.

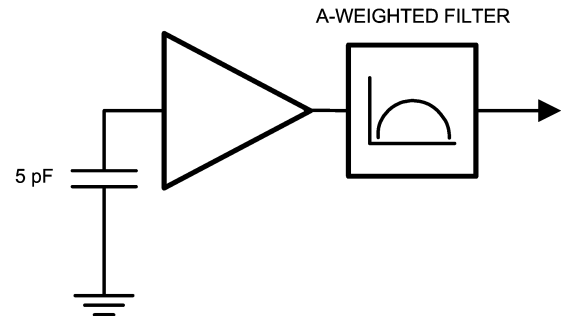

20058710

FIGURE 3. Noise Measurement Setup

The signal to noise ratio (SNR) is measured with a 1 kHz input signal of 18 mV<sub>PP</sub> using an A-weighted filter. This represents a sound pressure level of 94 dB SPL. No input capacitor is connected for the measurement.

### SOUND PRESSURE LEVEL

The volume of sound applied to a microphone is usually stated as a pressure level referred to the threshold of hearing of the human ear. The sound pressure level (SPL) in decibels is defined by:

$$\text{Sound pressure level (dB)} = 20 \log P_m/P_o$$

Where,

$P_m$  is the measured sound pressure

$P_o$  is the threshold of hearing (20  $\mu$ Pa)

In order to be able to calculate the resulting output voltage of the microphone for a given SPL, the sound pressure in dB

## Application Section (Continued)

SPL needs to be converted to the absolute sound pressure in dBPa. This is the sound pressure level in decibels referred to 1 Pascal (Pa).

The conversion is given by:

$$\text{dBPa} = \text{dB SPL} + 20 \cdot \log 20 \mu\text{Pa}$$

$$\text{dBPa} = \text{dB SPL} - 94 \text{ dB}$$

Translation from absolute sound pressure level to a voltage is specified by the sensitivity of the microphone. A conventional microphone has a sensitivity of -44 dBV/Pa.

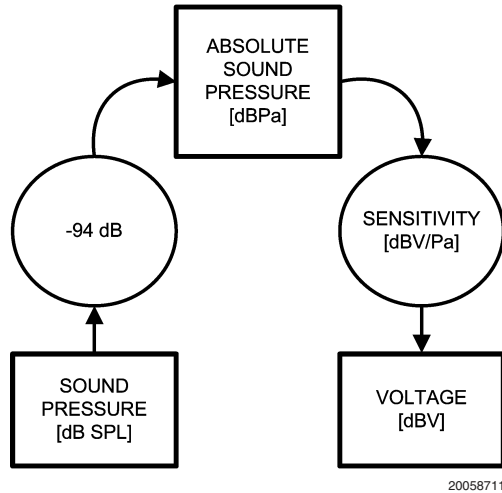

**FIGURE 4. dB SPL to dBV Conversion**

Example: Busy traffic is 70 dB SPL

$$V_{\text{OUT}} = 70 - 94 - 44 = -68 \text{ dBV}$$

This is equivalent to 1.13 mV<sub>PP</sub>

Since the LMV1012-15 has a gain of 6 (15.6 dB) over the JFET, the output voltage of the microphone is 6.78 mV<sub>PP</sub>. By implementing the LMV1012-15, the sensitivity of the microphone is -28.4 dBV/Pa (-44 + 15.6).

### LOW FREQUENCY CUT OFF FILTER

To reduce noise on the output of the microphone a low frequency cut off filter has been implemented. This filter reduces the effect of wind and handling noise.

It's also helpful to reduce the proximity effect in directional microphones. This effect occurs when the sound source is very close to the microphone. The lower frequencies are

amplified which gives a bass sound. This amplification can cause an overload, which results in a distortion of the signal.

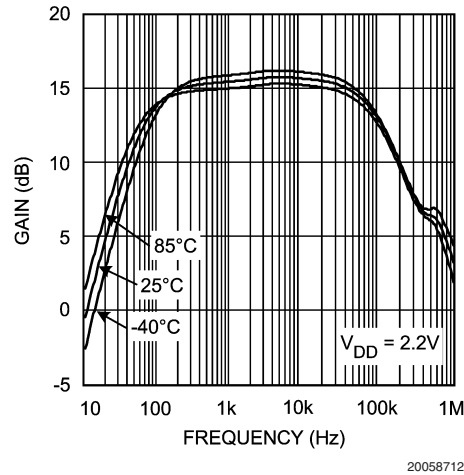

**FIGURE 5. LMV1012-15 Gain vs. Frequency Over Temperature**

The LMV1012 is optimized to be used in audio band applications. By using the LMV1012, the gain response is flat within the audio band and has linearity and temperature stability *Figure 5*.

### NOISE

Noise pick-up by a microphone in cell phones is a well-known problem. A conventional JFET circuit is sensitive for noise pick-up because of its high output impedance, which is usually around 2.2 kΩ.

RF noise is amongst other caused by non-linear behavior. The non-linear behavior of the amplifier at high frequencies, well above the usable bandwidth of the device, causes AM-demodulation of high frequency signals. The AM modulation contained in such signals folds back into the audio band, thereby disturbing the intended microphone signal. The GSM signal of a cell phone is such an AM-modulated signal. The modulation frequency of 216 Hz and its harmonics can be observed in the audio band. This kind of noise is called bumblebee noise.

RF noise caused by a GSM signal can be reduced by connecting two external capacitors to ground, see *Figure 6*. One capacitor reduces the noise caused by the 900 MHz carrier and the other reduces the noise caused by 1800/1900 MHz.

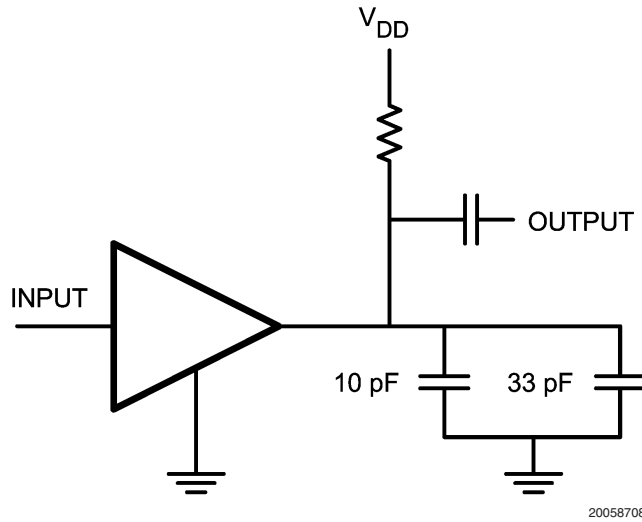
**Application Section** (Continued)**FIGURE 6. RF Noise Reduction**

**Physical Dimensions** inches (millimeters) unless otherwise noted

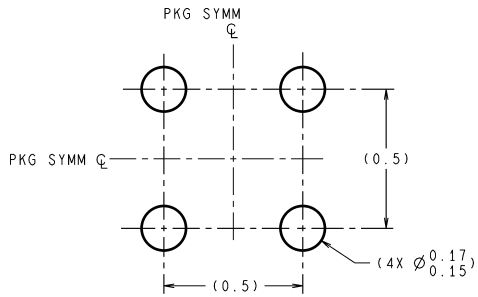

**DIMENSIONS ARE IN MILLIMETERS**  
DIMENSIONS IN ( ) FOR REFERENCE ONLY

**LAND PATTERN RECOMMENDATION**

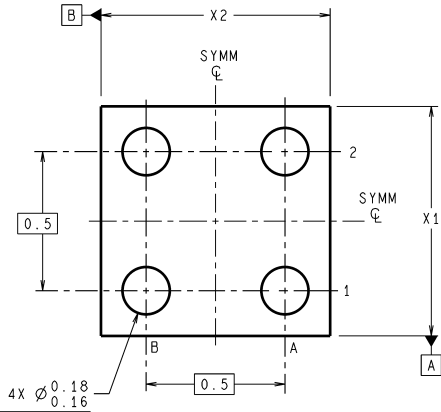
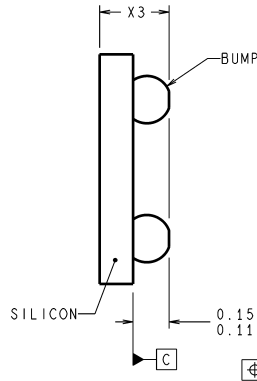
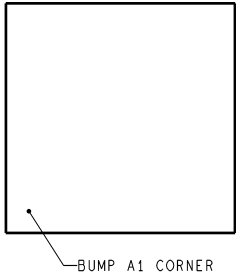

Φ 0.001 C A B

XPA04XXX (Rev B)

NOTE: UNLESS OTHERWISE SPECIFIED.

1. FOR SOLDER BUMP COMPOSITION, SEE "SOLDER INFORMATION" IN THE PACKAGING SECTION OF THE NATIONAL SEMICONDUCTOR WEB PAGE ([www.national.com](http://www.national.com)).
2. RECOMMEND NON-SOLDER MASK DEFINED LANDING PAD.
3. PIN A1 IS ESTABLISHED BY LOWER LEFT CORNER WITH RESPECT TO TEXT ORIENTATION.
4. XXX IN DRAWING NUMBER REPRESENTS PACKAGE SIZE VARIATION WHERE X1 IS PACKAGE WIDTH, X2 IS PACKAGE LENGTH AND X3 IS PACKAGE HEIGHT.
5. REFERENCE JEDEC REGISTRATION MO-211. VARIATION CA.

**4-Bump Extreme Thin micro SMD**  
**NS Package Number XPA04HLA**  
**X<sub>1</sub> = 0.955 mm X<sub>2</sub> = 1.031 mm X<sub>3</sub> = 0.300 mm**

**Physical Dimensions** inches (millimeters) unless otherwise noted (Continued)

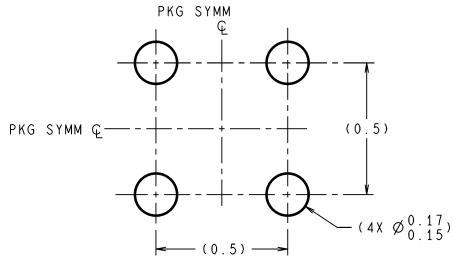

DIMENSIONS ARE IN MILLIMETERS

**LAND PATTERN RECOMMENDATION**

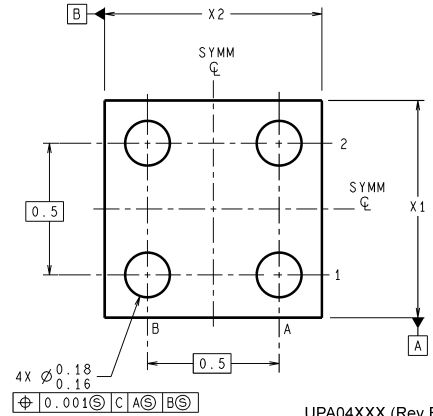
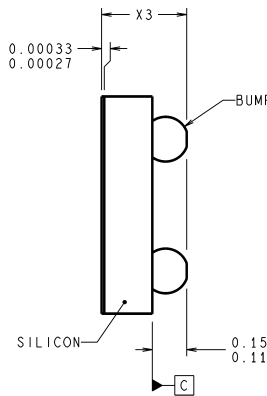
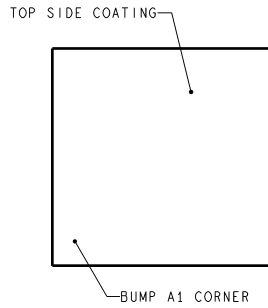

UPA04XXX (Rev B)

NOTE: UNLESS OTHERWISE SPECIFIED.

1. TITANIUM COATING.
2. FOR SOLDER BUMP COMPOSITION, SEE "SOLDER INFORMATION" IN THE PACKAGING SECTION OF THE NATIONAL SEMICONDUCTOR WEB PAGE ([www.national.com](http://www.national.com)).
3. RECOMMEND NON-SOLDER MASK DEFINED LANDING PAD.
4. PIN A1 IS ESTABLISHED BY LOWER LEFT CORNER WITH RESPECT TO TEXT ORIENTATION.
5. XXX IN DRAWING NUMBER REPRESENTS PACKAGE SIZE VARIATION WHERE X1 IS PACKAGE WIDTH, X2 IS PACKAGE LENGTH AND X3 IS PACKAGE HEIGHT.
6. REFERENCE JEDEC REGISTRATION MO-211. VARIATION CA.

**4-Bump ULTRA-Thin micro SMD**  
**NS Package Number UPA04GKA**  
**X<sub>1</sub> = 0.93 mm X<sub>2</sub> = 1.006 mm X<sub>3</sub> = 0.400 mm**

**Physical Dimensions** inches (millimeters) unless otherwise noted (Continued)

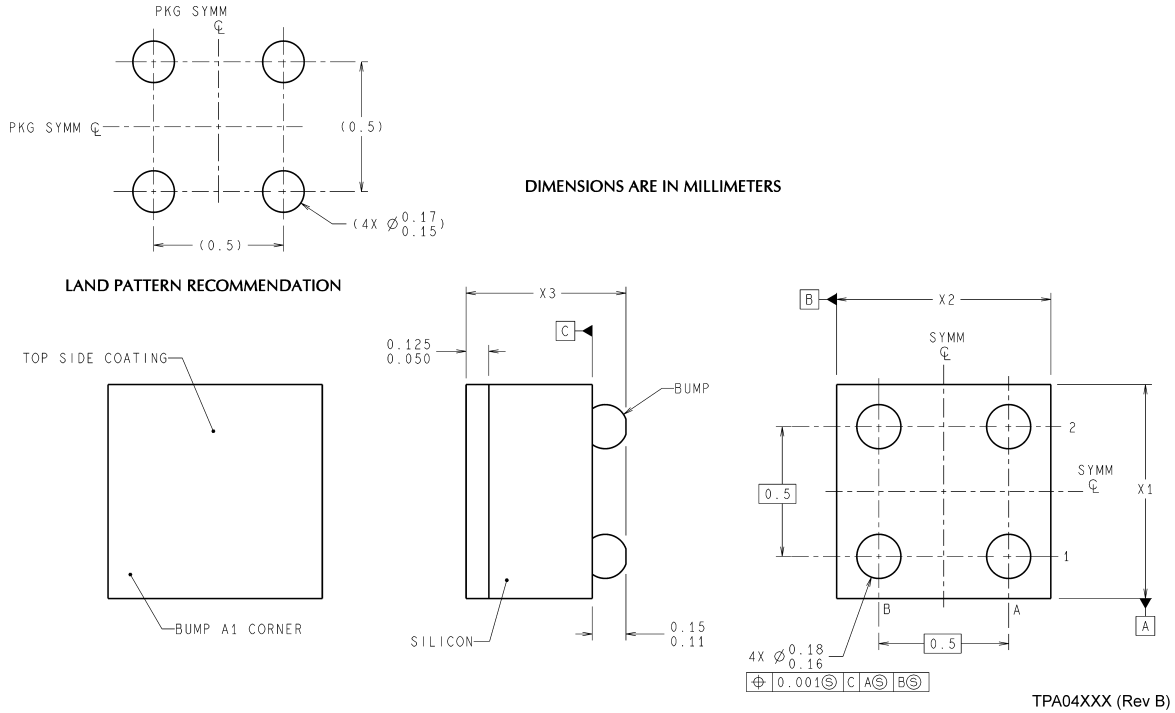

NOTE: UNLESS OTHERWISE SPECIFIED.

1. EPOXY COATING.
2. 63Sn/37Pb EUTECTIC BUMP.
3. RECOMMEND NON-SOLDER MASK DEFINED LANDING PAD.
4. PIN A1 IS ESTABLISHED BY LOWER LEFT CORNER WITH RESPECT TO TEXT ORIENTATION PINS ARE NUMBERED COUNTERCLOCKWISE.
5. XXX IN DRAWING NUMBER REPRESENTS PACKAGE SIZE VARIATION WHERE X1 IS PACKAGE WIDTH, X2 IS PACKAGE LENGTH AND X3 IS PACKAGE HEIGHT.
6. REFERENCE JEDEC REGISTRATION MO-211. VARIATION BC.

**4-Bump Thin micro SMD**  
**NS Package Number TPA04GKA**  
**X<sub>1</sub> = 0.93 mm X<sub>2</sub> = 1.006 mm X<sub>3</sub> = 0.500 mm**

**LIFE SUPPORT POLICY**

NATIONAL'S PRODUCTS ARE NOT AUTHORIZED FOR USE AS CRITICAL COMPONENTS IN LIFE SUPPORT DEVICES OR SYSTEMS WITHOUT THE EXPRESS WRITTEN APPROVAL OF THE PRESIDENT AND GENERAL COUNSEL OF NATIONAL SEMICONDUCTOR CORPORATION. As used herein:

1. Life support devices or systems are devices or systems which, (a) are intended for surgical implant into the body, or (b) support or sustain life, and whose failure to perform when properly used in accordance with instructions for use provided in the labeling, can be reasonably expected to result in a significant injury to the user.
2. A critical component is any component of a life support device or system whose failure to perform can be reasonably expected to cause the failure of the life support device or system, or to affect its safety or effectiveness.

**BANNED SUBSTANCE COMPLIANCE**

National Semiconductor certifies that the products and packing materials meet the provisions of the Customer Products Stewardship Specification (CSP-9-111C2) and the Banned Substances and Materials of Interest Specification (CSP-9-111S2) and contain no "Banned Substances" as defined in CSP-9-111S2.



**National Semiconductor**  
**Americas Customer Support Center**  
 Email: new.feedback@nsc.com  
 Tel: 1-800-272-9959

**National Semiconductor**  
**Europe Customer Support Center**  
 Fax: +49 (0) 180-530 85 86  
 Email: europe.support@nsc.com  
 Deutsch Tel: +49 (0) 69 9508 6208  
 English Tel: +44 (0) 870 24 0 2171  
 Français Tel: +33 (0) 1 41 91 8790

**National Semiconductor**  
**Asia Pacific Customer Support Center**  
 Email: ap.support@nsc.com

**National Semiconductor**  
**Japan Customer Support Center**  
 Fax: 81-3-5639-7507  
 Email: jpn.feedback@nsc.com  
 Tel: 81-3-5639-7560

www.national.com