

# LMV791

## 17 MHz, Low Noise, CMOS Input, 1.8V Operational Amplifier

### General Description

The LMV791 low noise, CMOS input operational amplifier offers a low input voltage noise density of 5.8 nV/√Hz while consuming only 1.15 mA of quiescent current. The LMV791 is a unity gain stable op amp and has a gain bandwidth of 17 MHz. The LMV791 has a supply voltage range of 1.8V to 5.5V and can operate from a single supply. The LMV791 features a rail-to-rail output stage capable of driving a 600Ω load and sourcing as much as 60 mA of current.

The LMV791 provides optimal performance in low voltage and low noise systems. A CMOS input stage, with typical input bias currents in the range of a few femtoAmperes, and an input common mode voltage range which includes ground make the LMV791 ideal for low power sensor applications. The LMV791 has a built-in enable feature which can be used to optimize power dissipation in low power applications.

The LMV791 is manufactured using National's advanced VIP50 process and is available in a 6-pin TSOT23 package.

### Features

(Typical 5V supply, unless otherwise noted)

- Input referred voltage noise 5.8 nV/√Hz
- Input bias current 0.1 pA
- Unity gain bandwidth 17 MHz
- Supply current 1.15 mA
- Guaranteed 2.5V and 5.0V performance
- Rail-to-rail output swing
  - @ 10 kΩ load 25 mV from rail
  - @ 2 kΩ load 35 mV from rail
- Total harmonic distortion 0.01% @1 kHz, 600Ω
- Temperature range -40°C to 125°C

### Applications

- Photodiode Amplifiers
- Active filters and buffers
- Low noise signal processing
- Medical Instrumentation
- Sensor interface applications

### Typical Application

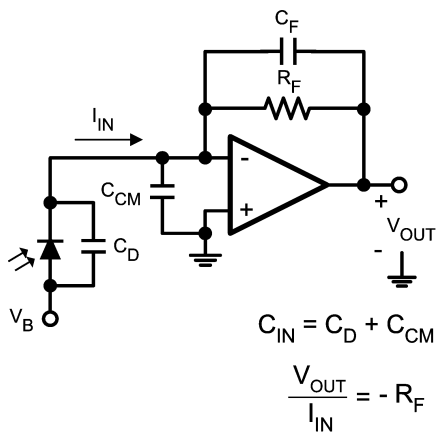

20116869  
**Photodiode Transimpedance Amplifier**

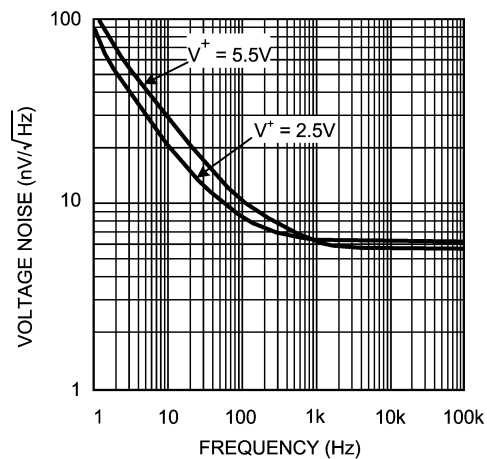

20116839  
**Input Referred Voltage Noise vs. Frequency**

**Absolute Maximum Ratings** (Note 1)

If Military/Aerospace specified devices are required, please contact the National Semiconductor Sales Office/Distributors for availability and specifications.

ESD Tolerance (Note 2)	
Human Body	±2000V
Machine Model	±200V
V <sub>IN</sub> Differential	0.3V
Supply Voltage (V <sup>+</sup> – V <sup>-</sup> )	6.0V
Input/Output Pin Voltage	V <sup>+</sup> +0.3V, V <sup>-</sup> –0.3V
Storage Temperature Range	–65°C to 150°C
Junction Temperature (Note 3)	+150°C

## Soldering Information

Infrared or Convection (20 sec)	235°C
Wave Soldering Lead Temp (10 sec)	260°C

**Operating Ratings** (Note 1)

Temperature Range (Note 3)	–40°C to 125°C
Supply Voltage (V <sup>+</sup> – V <sup>-</sup> )	2V to 5.5V
–40°C ≤ T <sub>A</sub> ≤ 125°C	1.8V to 5.5V
0°C ≤ T <sub>A</sub> ≤ 125°C	
Package Thermal Resistance (θ <sub>JA</sub> (Note 3))	170°C/W
6-Pin TSOT23	

**2.5V Electrical Characteristics**

Unless otherwise specified, all limits are guaranteed for T<sub>A</sub> = 25°C, V<sup>+</sup> = 2.5V, V<sup>-</sup> = 0V, V<sub>CM</sub> = V<sup>+</sup>/2, V<sub>EN</sub> = V<sup>+</sup>. **Boldface** limits apply at the temperature extremes.

Symbol	Parameter	Conditions	Min (Note 5)	Typ (Note 4)	Max (Note 5)	Units
V <sub>OS</sub>	Input Offset Voltage			0.1	±1.35 <b>±1.65</b>	mV
TC V <sub>OS</sub>	Input Offset Average Drift	(Note 6)		1.0		µV/°C
I <sub>B</sub>	Input Bias Current	V <sub>CM</sub> = 1.0V (Notes 7, 8)		0.05	0.5 <b>50</b>	pA
I <sub>OS</sub>	Input Offset Current	(Note 8)		10		fA
CMRR	Common Mode Rejection Ratio	0V ≤ V <sub>CM</sub> ≤ 1.4V	80 <b>75</b>	94		dB
PSRR	Power Supply Rejection Ratio	2V ≤ V <sup>+</sup> ≤ 5.5V, V <sub>CM</sub> = 0V	80 <b>75</b>	100		dB
		1.8V ≤ V <sup>+</sup> ≤ 5.5V, V <sub>CM</sub> = 0V	80	98		
CMVR	Input Common-Mode Voltage Range	CMRR ≥ 60 dB <b>CMRR ≥ 55 dB</b>	–0.3 <b>–0.3</b>		1.5 <b>1.5</b>	V
A <sub>VOL</sub>	Large Signal Voltage Gain	V <sub>OUT</sub> = 0.15V to 2.2V, R <sub>LOAD</sub> = 2 kΩ to V <sup>+</sup> /2	85 <b>80</b>	98		dB
		V <sub>OUT</sub> = 0.15V to 2.2V, R <sub>LOAD</sub> = 10 kΩ to V <sup>+</sup> /2	88 <b>84</b>	110		
V <sub>OUT</sub>	Output Swing High	R <sub>LOAD</sub> = 2 kΩ to V <sup>+</sup> /2	75 <b>82</b>	25		mV from rail
		R <sub>LOAD</sub> = 10 kΩ to V <sup>+</sup> /2	65 <b>71</b>	20		
	Output Swing Low	R <sub>LOAD</sub> = 2 kΩ to V <sup>+</sup> /2		30	75 <b>78</b>	
		R <sub>LOAD</sub> = 10 kΩ to V <sup>+</sup> /2		15	65 <b>67</b>	
I <sub>OUT</sub>	Output Short Circuit Current	Sourcing to V <sup>-</sup> V <sub>IN</sub> = 200 mV (Note 9)	35 <b>28</b>	47		mA
		Sinking to V <sup>+</sup> V <sub>IN</sub> = –200 mV (Note 9)	7 <b>5</b>	15		
I <sub>S</sub>	Supply Current per Amplifier	Enable Mode V <sub>EN</sub> > 2.1		0.95	1.30 <b>1.65</b>	mA
		Shutdown Mode V <sub>EN</sub> < 0.4		0.02	1 <b>5</b>	

## 2.5V Electrical Characteristics (Continued)

SR	Slew Rate	$A_V = +1$ , Rising (10% to 90%)		8.5		V/ $\mu$ s
		$A_V = +1$ , Falling (90% to 10%)		10.5		
GBWP	Gain Bandwidth Product			14		MHz
$e_n$	Input-Referred Voltage Noise	$f = 1$ kHz		6.2		nV/ $\sqrt{\text{Hz}}$
$i_n$	Input-Referred Current Noise	$f = 1$ kHz		0.01		pA/ $\sqrt{\text{Hz}}$
$t_{on}$	Turn-on Time			140		ns
$t_{off}$	Turn-off Time			1000		ns
$V_{EN}$	Enable Pin Voltage Range	Enable Mode	2.1 to 2.5	2 to 2.5		V
		Shutdown Mode	0 to 0.4	0 to 0.5		
$I_{EN}$	Enable Pin Input Current	Enable Mode $V_{EN} > 2.1\text{V}$ (Note 7)		1.5	3	$\mu$ A
		Shutdown Mode $V_{EN} < 0.4\text{V}$ (Note 7)		0.003	0.1	
THD+N	Total Harmonic Distortion + Noise	$f = 1$ kHz, $A_V = 1$ , $R_{LOAD} = 600\Omega$		0.01		%

## 5V Electrical Characteristics

Unless otherwise specified, all limits guaranteed for  $T_A = 25^\circ\text{C}$ ,  $V^+ = 5\text{V}$ ,  $V^- = 0\text{V}$ ,  $V_{CM} = V^+/2$ ,  $V_{EN} = V^+$ . **Boldface** limits apply at the temperature extremes.

Symbol	Parameter	Conditions	Min (Note 5)	Typ (Note 4)	Max (Note 5)	Units
$V_{OS}$	Input Offset Voltage			0.1	$\pm 1.35$ <b><math>\pm 1.65</math></b>	mV
TC $V_{OS}$	Input Offset Average Drift	(Note 6)		1.0		$\mu\text{V}/^\circ\text{C}$
$I_B$	Input Bias Current	$V_{CM} = 2.0\text{V}$ (Notes 7, 8)		0.1	1 <b>100</b>	pA
$I_{OS}$	Input Offset Current	(Note 8)		10		fA
CMRR	Common Mode Rejection Ratio	$0\text{V} \leq V_{CM} \leq 3.7\text{V}$	80 <b>75</b>	100		dB
		$1.8\text{V} \leq V^+ \leq 5.5\text{V}$ , $V_{CM} = 0\text{V}$	80	98		
PSRR	Power Supply Rejection Ratio	$2\text{V} \leq V^+ \leq 5.5\text{V}$ , $V_{CM} = 0\text{V}$	80 <b>75</b>	100		dB
		$1.8\text{V} \leq V^+ \leq 5.5\text{V}$ , $V_{CM} = 0\text{V}$	80	98		
CMVR	Input Common-Mode Voltage Range	CMRR $\geq 60$ dB <b>CMRR <math>\geq 55</math> dB</b>	-0.3 <b>-0.3</b>		4 <b>4</b>	V
$A_{VOL}$	Large Signal Voltage Gain	$V_{OUT} = 0.3\text{V}$ to $4.7\text{V}$ , $R_{LOAD} = 2$ k $\Omega$ to $V^+/2$	85 <b>80</b>	97		dB
		$V_{OUT} = 0.3\text{V}$ to $4.7\text{V}$ , $R_{LOAD} = 10$ k $\Omega$ to $V^+/2$	88 <b>84</b>	110		
$V_{OUT}$	Output Swing High	$R_{LOAD} = 2$ k $\Omega$ to $V^+/2$	75 <b>82</b>	35		mV from rail
		$R_{LOAD} = 10$ k $\Omega$ to $V^+/2$	65 <b>71</b>	25		
	Output Swing Low	$R_{LOAD} = 2$ k $\Omega$ to $V^+/2$		50	75 <b>78</b>	
		$R_{LOAD} = 10$ k $\Omega$ to $V^+/2$		20	65 <b>67</b>	
$I_{OUT}$	Output Short Circuit Current	Sourcing to $V^-$ $V_{IN} = 200$ mV (Note 9)	45 <b>37</b>	60		mA
		Sinking to $V^+$ $V_{IN} = -200$ mV (Note 9)	10 <b>6</b>	21		
$I_S$	Supply Current per Amplifier	Enable Mode ( $V_{EN} > 4.6$ V)		1.15	1.40 <b>1.75</b>	mA
		Shutdown Mode ( $V_{EN} < 0.4\text{V}$ )		0.14	1 <b>5</b>	

## 5V Electrical Characteristics (Continued)

SR	Slew Rate	$A_V = +1$ , Rising (10% to 90%)	6.0	9.5		V/ $\mu$ s
		$A_V = +1$ , Falling (90% to 10%)	7.5	11.5		
GBWP	Gain Bandwidth Product			17		MHz
$e_n$	Input - Referred Voltage Noise	$f = 1$ kHz		5.8		nV/ $\sqrt{\text{Hz}}$
$i_n$	Input-Referred Current Noise	$f = 1$ kHz		0.01		pA/ $\sqrt{\text{Hz}}$
$t_{\text{on}}$	Turn-on Time			110		ns
$t_{\text{off}}$	Turn-off Time			800		ns
$V_{\text{EN}}$	Enable Pin Voltage Range	Enable Mode	4.6 to 5	4.5 to 5		V
		Shutdown Mode	0 to 0.4	0 to 0.5		
$I_{\text{EN}}$	Enable Pin Input Current	Enable Mode $V_{\text{EN}} > 4.6\text{V}$ (Note 7)		5.6	10	$\mu\text{A}$
		Shutdown Mode $V_{\text{EN}} < 0.4\text{V}$ (Note 7)		0.005	0.2	
THD+N	Total Harmonic Distortion + Noise	$f = 1$ kHz, $A_V = 1$ , $R_{\text{LOAD}} = 600\Omega$		0.01		%

**Note 1:** Absolute Maximum Ratings indicate limits beyond which damage to the device may occur. Operating Ratings indicate conditions for which the device is intended to be functional, but specific performance is not guaranteed. For guaranteed specifications and the test conditions, see the Electrical Characteristics Tables.

**Note 2:** Human Body Model: 1.5 k $\Omega$  in series with 100 pF. Machine Model: 0 $\Omega$  in series with 200 pF

**Note 3:** The maximum power dissipation is a function of  $T_{\text{J(MAX)}}$ ,  $\theta_{\text{JA}}$ . The maximum allowable power dissipation at any ambient temperature is  $P_{\text{D}} = (T_{\text{J(MAX)}} - T_{\text{A}})/\theta_{\text{JA}}$ . All numbers apply for packages soldered directly onto a PC Board.

**Note 4:** Typical values represent the parametric norm at the time of characterization.

**Note 5:** Limits are 100% production tested at 25°C. Limits over the operating temperature range are guaranteed through correlations using the statistical quality control (SQC) method.

**Note 6:** Offset voltage average drift is determined by dividing the change in  $V_{\text{OS}}$  by temperature change.

**Note 7:** Positive current corresponds to current flowing into the device.

**Note 8:** Input bias current and input offset current are guaranteed by design

**Note 9:** The short circuit test is a momentary test, the short circuit duration is 1.5 ms.

## Connection Diagram

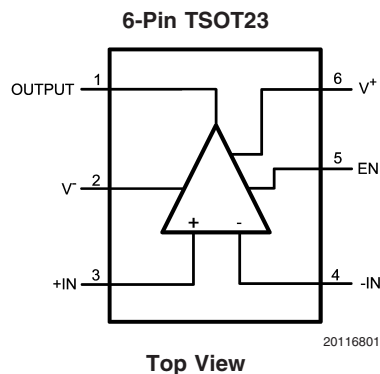

## Ordering Information

Package	Part Number	Package Marking	Transport Media	NSC Drawing
6-Pin TSOT23	LMV791MK	AS1A	1k Units Tape and Reel	MK06A
	LMV791MKX		3k Units Tape and Reel	

# Typical Performance Characteristics

Unless otherwise specified,  $T_A = 25^\circ\text{C}$ ,  $V^- = 0$ ,  $V^+ = \text{Supply}$

Voltage = 5V,  $V_{CM} = V^+/2$ ,  $V_{EN} = V^+$

Supply Current vs. Supply Voltage

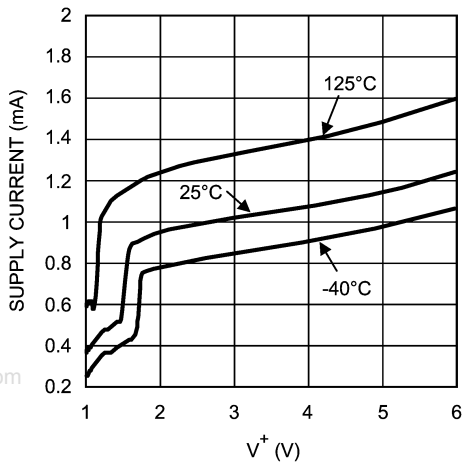

20116805

Supply Current vs. Supply Voltage in Shutdown Mode

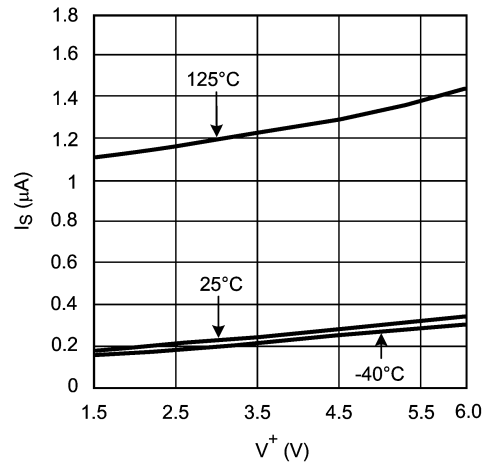

20116806

$V_{OS}$  vs.  $V_{CM}$

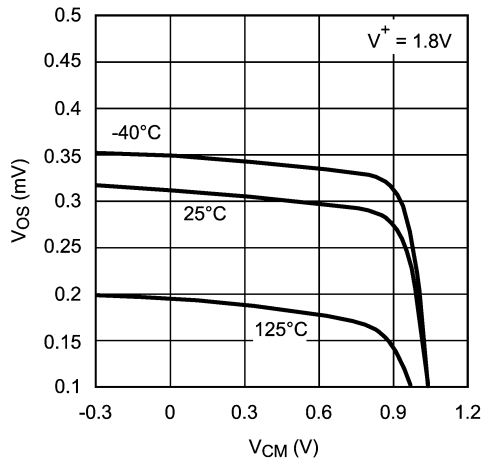

20116809

$V_{OS}$  vs.  $V_{CM}$

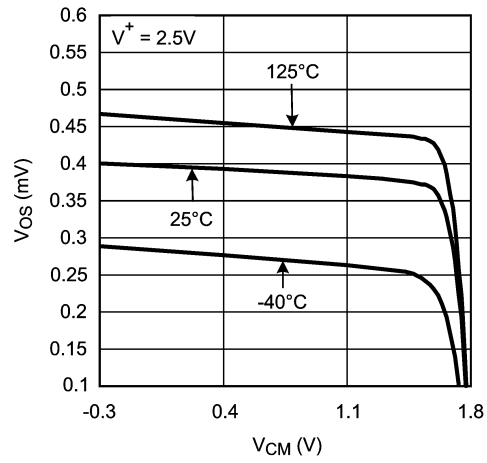

20116851

$V_{OS}$  vs.  $V_{CM}$

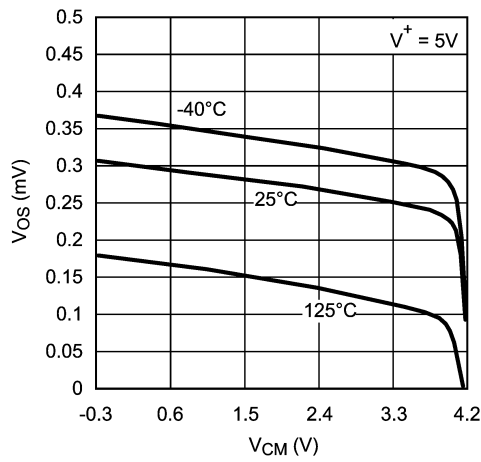

20116811

$V_{OS}$  vs. Supply Voltage

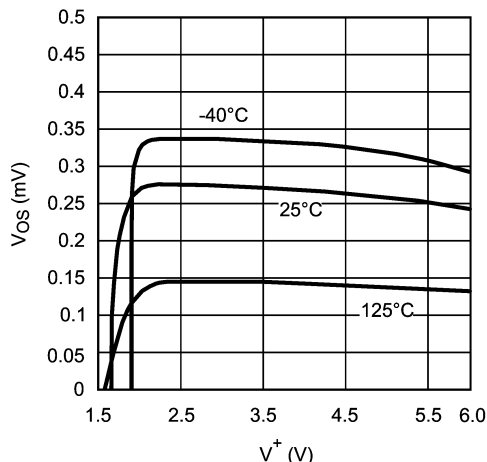

20116812

**Typical Performance Characteristics** Unless otherwise specified,  $T_A = 25^\circ\text{C}$ ,  $V^- = 0$ ,  $V^+ = \text{Supply}$   
 Voltage = 5V,  $V_{CM} = V^+/2$ ,  $V_{EN} = V^+$  (Continued)

**Positive Output Swing vs. Supply Voltage**

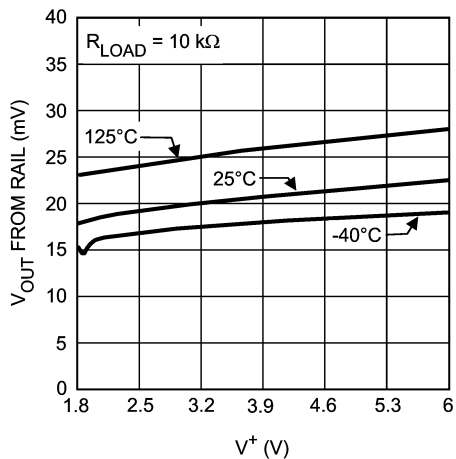

**Negative Output Swing vs. Supply Voltage**

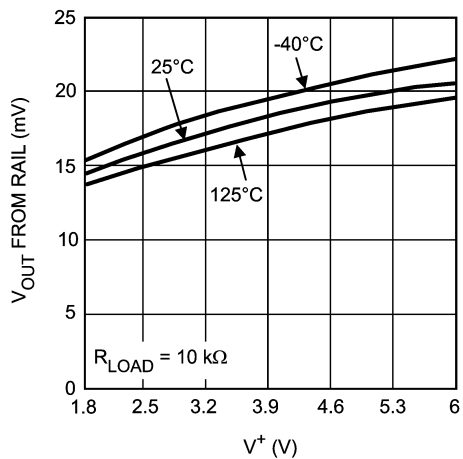

**Positive Output Swing vs. Supply Voltage**

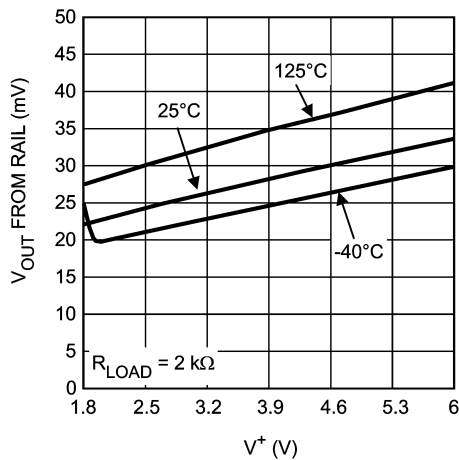

**Negative Output Swing vs. Supply Voltage**

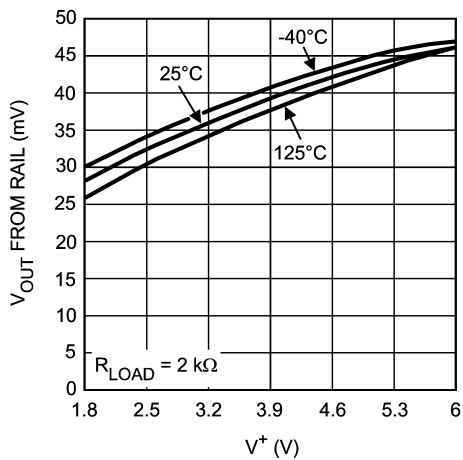

**Positive Output Swing vs. Supply Voltage**

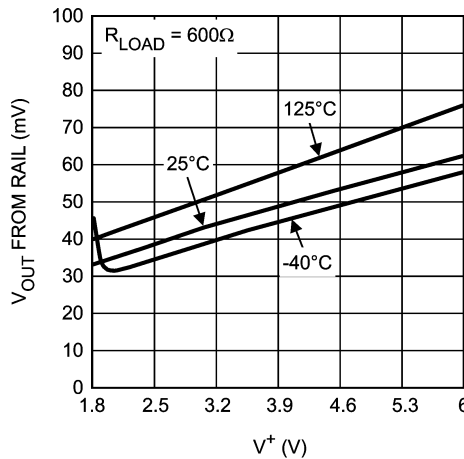

**Negative Output Swing vs. Supply Voltage**

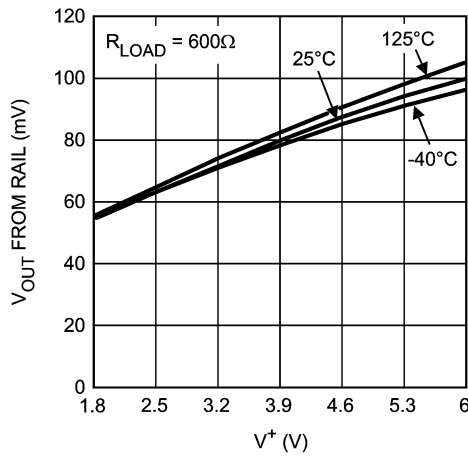

**Typical Performance Characteristics** Unless otherwise specified,  $T_A = 25^\circ\text{C}$ ,  $V^- = 0$ ,  $V^+ = \text{Supply}$   
 Voltage = 5V,  $V_{CM} = V^+/2$ ,  $V_{EN} = V^+$  (Continued)

**Sourcing Current vs. Supply Voltage**

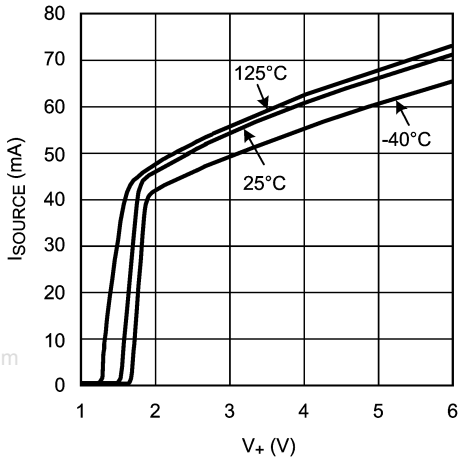

20116820

**Sinking Current vs. Supply Voltage**

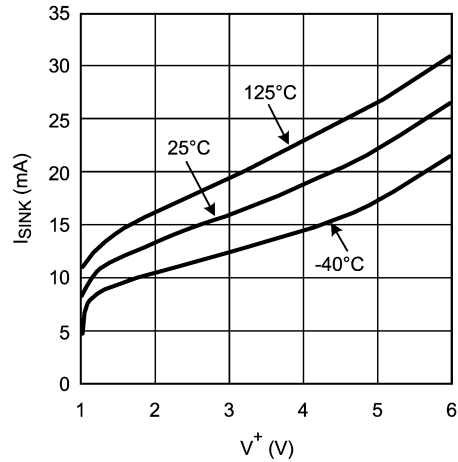

20116819

**Sourcing Current vs. Output Voltage**

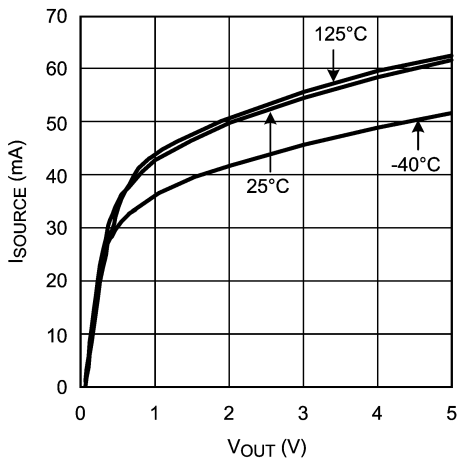

20116850

**Sinking Current vs. Output Voltage**

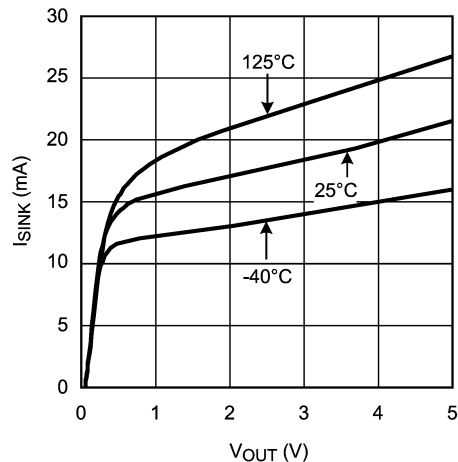

20116854

**Supply Current vs. Enable Pin Voltage**

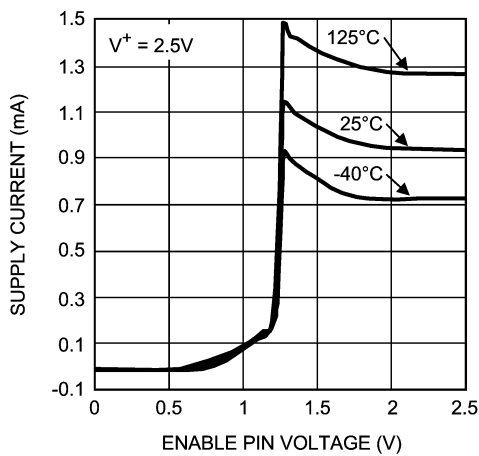

20116808

**Supply Current vs. Enable Pin Voltage**

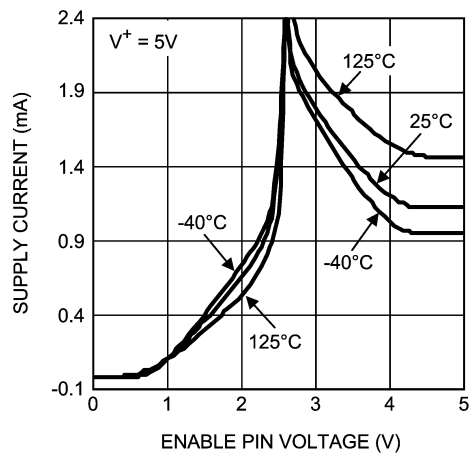

20116807

**Typical Performance Characteristics** Unless otherwise specified,  $T_A = 25^\circ\text{C}$ ,  $V^- = 0$ ,  $V^+ = \text{Supply}$   
 Voltage = 5V,  $V_{CM} = V^+/2$ ,  $V_{EN} = V^+$  (Continued)

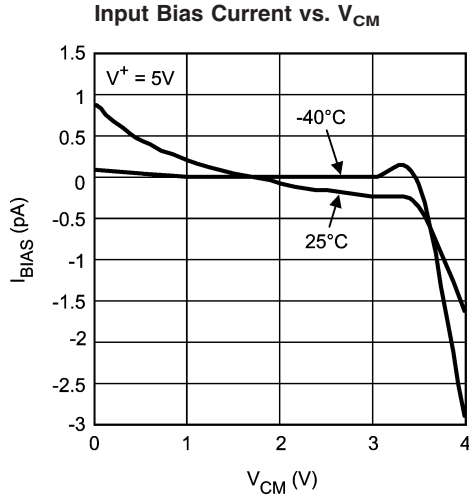

20116862

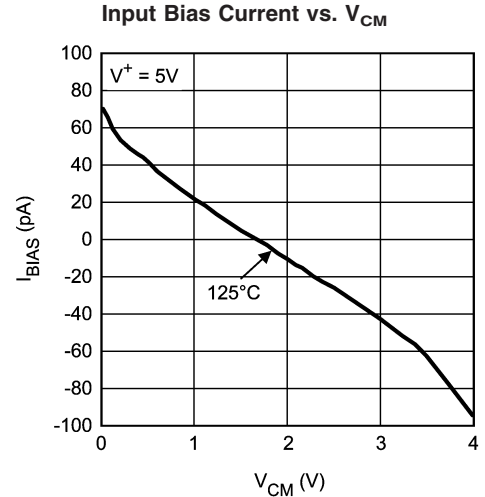

20116863

**Input Referred Voltage Noise vs. Frequency**

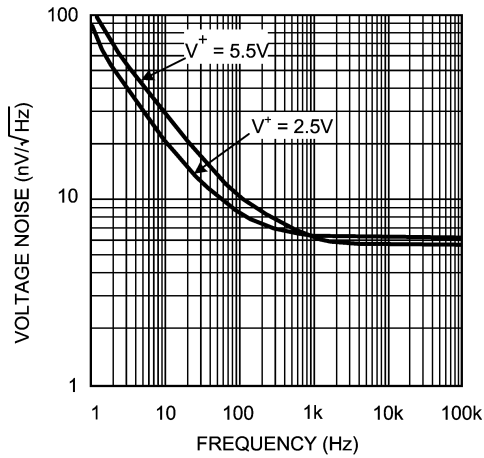

20116839

**THD+N vs. Peak-to-Peak Output Voltage ( $V_{OUT}$ )**

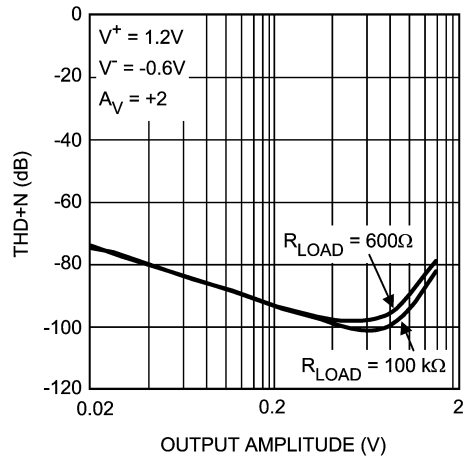

20116826

**THD+N vs. Peak-to-Peak Output Voltage ( $V_{OUT}$ )**

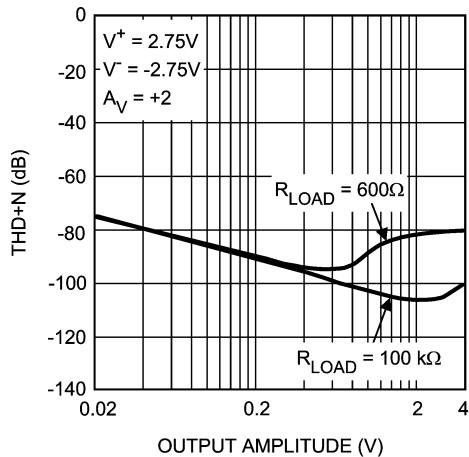

20116804

**THD+N vs. Frequency**

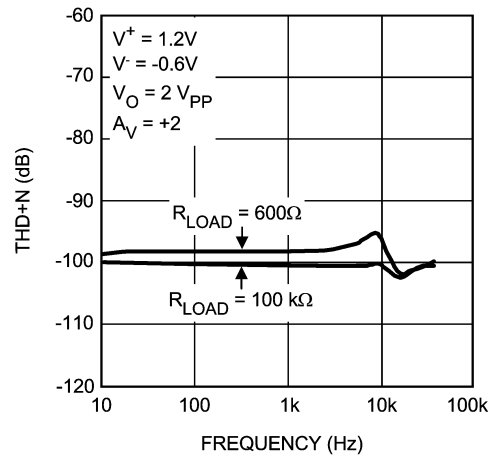

20116857



**Typical Performance Characteristics** Unless otherwise specified,  $T_A = 25^\circ\text{C}$ ,  $V^- = 0$ ,  $V^+ = \text{Supply}$   
 Voltage = 5V,  $V_{CM} = V^+/2$ ,  $V_{EN} = V^+$  (Continued)

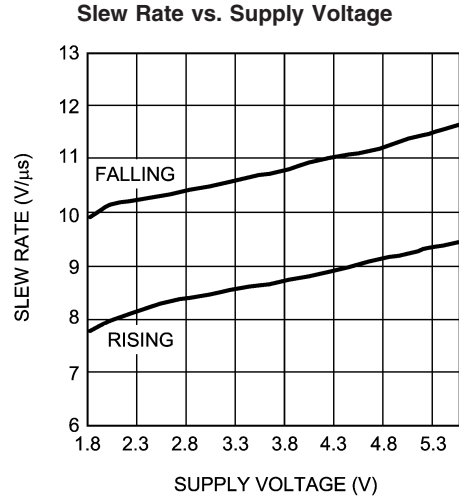
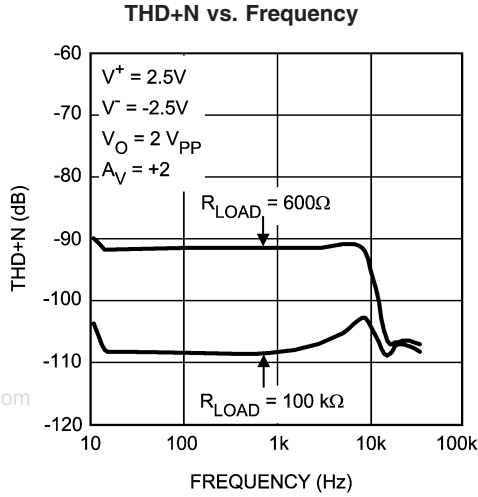

**Open Loop Gain and Phase with Capacitive Load**

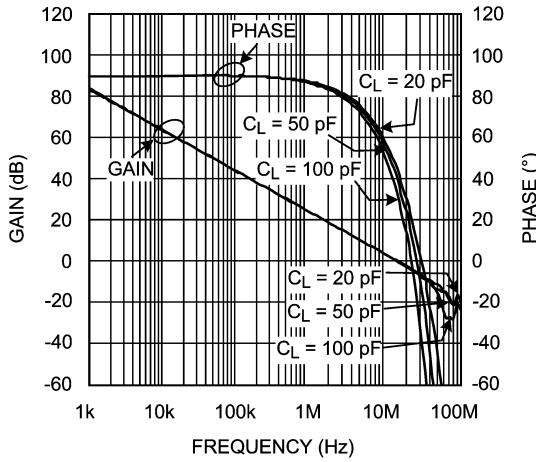

**Open Loop Gain and Phase with Resistive Load**

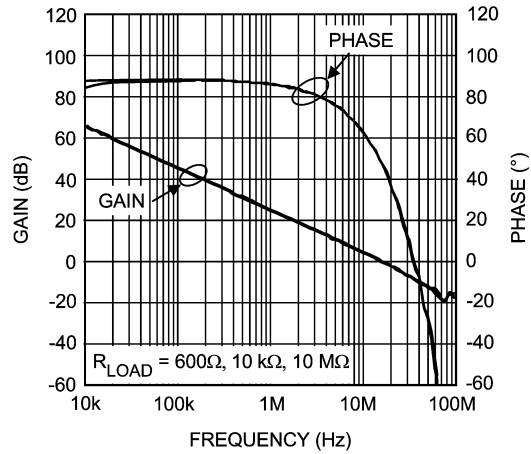

**Overshoot and Undershoot vs.  $C_{LOAD}$**

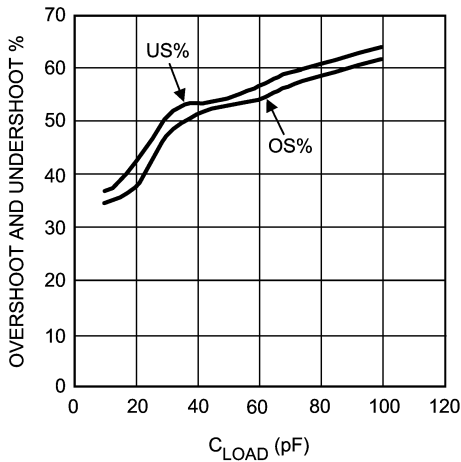

**Closed Loop Output Impedance vs. Frequency**

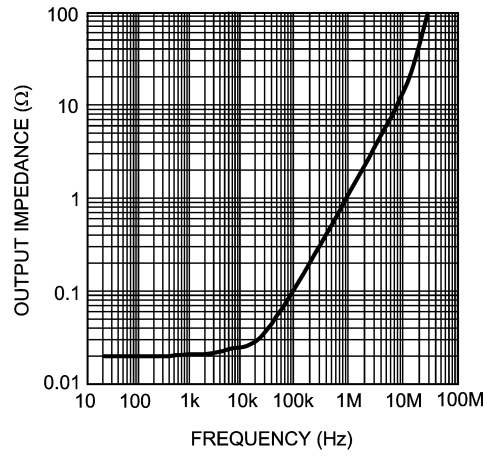

**Typical Performance Characteristics** Unless otherwise specified,  $T_A = 25^\circ\text{C}$ ,  $V^- = 0$ ,  $V^+ = \text{Supply}$   
 Voltage = 5V,  $V_{CM} = V^+/2$ ,  $V_{EN} = V^+$  (Continued)

**Small Signal Transient Response,  $A_V = +1$**

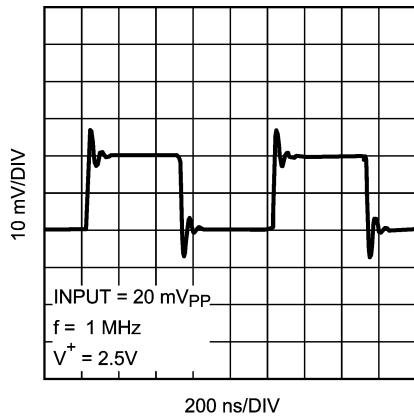

20116838

**Large Signal Transient Response,  $A_V = +1$**

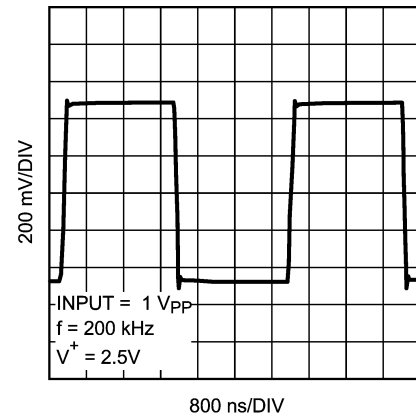

20116837

**Small Signal Transient Response,  $A_V = +1$**

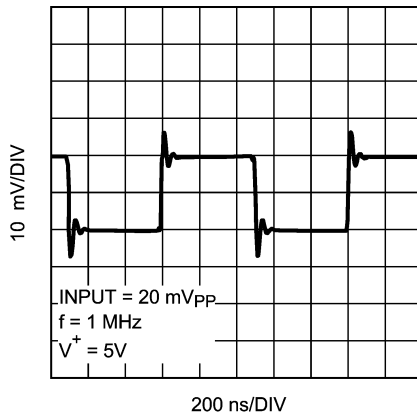

20116833

**Large Signal Transient Response,  $A_V = +1$**

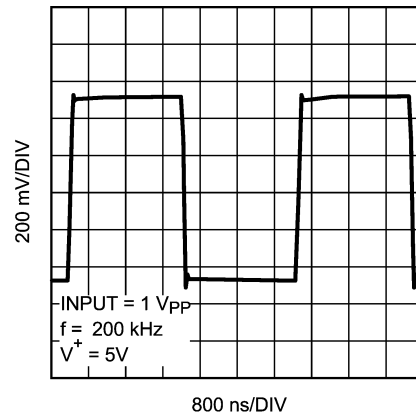

20116834

**Phase Margin vs. Capacitive Load (Stability)**

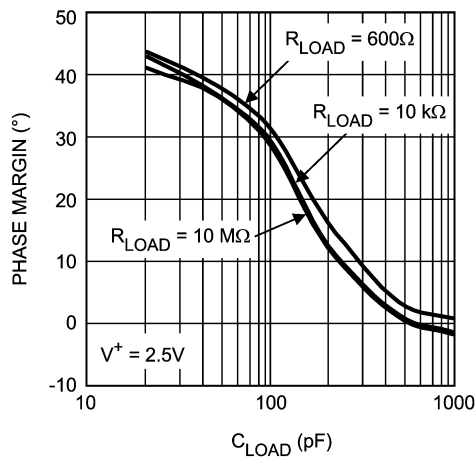

20116845

**Phase Margin vs. Capacitive Load (Stability)**

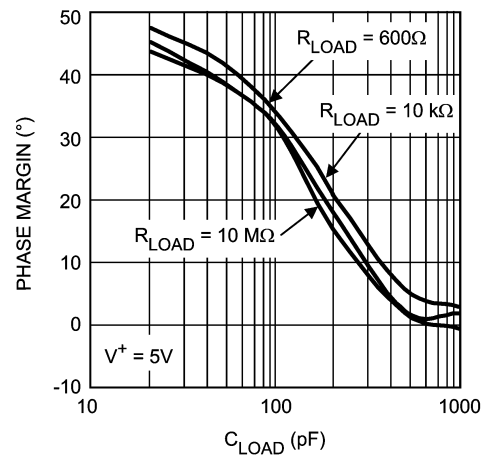

20116846

**Typical Performance Characteristics** Unless otherwise specified,  $T_A = 25^\circ\text{C}$ ,  $V^- = 0$ ,  $V^+ = \text{Supply}$   
 Voltage = 5V,  $V_{CM} = V^+/2$ ,  $V_{EN} = V^+$  (Continued)

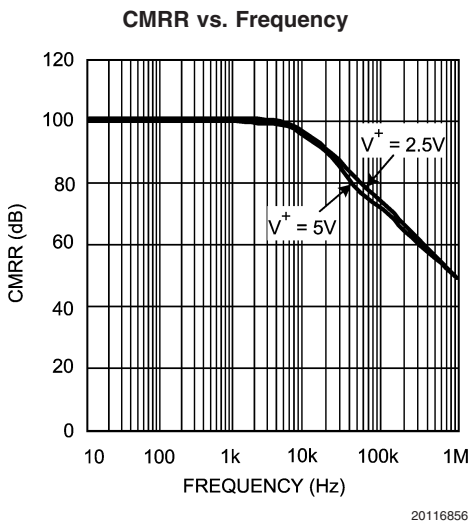
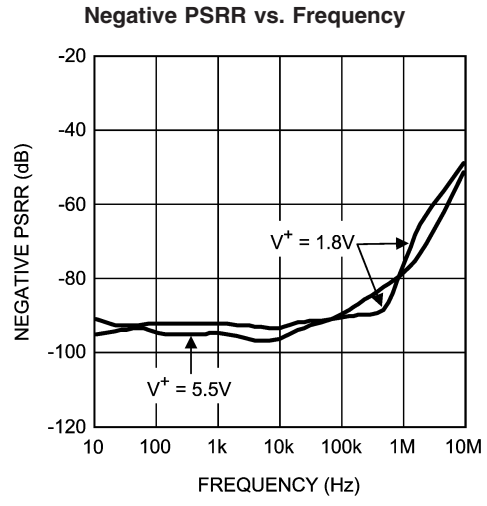
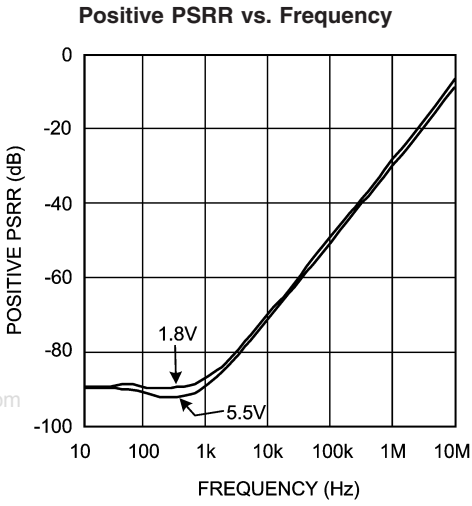

www.DataSheet4U.com

## Application Notes

### ADVANTAGES OF THE LMV791

#### Wide Bandwidth at Low Supply Current

The LMV791 is a high performance op amp that provides a unity gain bandwidth of 17 MHz while drawing a low supply current of merely 1.15 mA. This makes it ideal for providing wideband amplification in portable applications. The enable and shutdown feature can also be used to design more power efficient systems and obtain wider bandwidth and better performance while using less power.

#### Low Input Referred Noise and Low Input Bias Current

The LMV791 has a very low input referred voltage noise density ( $5.8 \text{ nV}/\sqrt{\text{Hz}}$  at 1 kHz). A CMOS input stage ensures a small input bias current (100 fA) and, hence, the input referred current noise is very low ( $0.01 \text{ pA}/\sqrt{\text{Hz}}$ ). This is very helpful in maintaining signal fidelity, and makes the LMV791 ideal for audio and sensor based applications.

#### Low Supply Voltage

LMV791 is guaranteed to perform at 2.5V and 5V supply. The LMV791 is guaranteed to be operational at all supply voltages between 2V and 5.5V, for ambient temperatures ranging from  $-40^\circ\text{C}$  to  $125^\circ\text{C}$ , thus utilizing the entire battery lifetime. The LMV791 is also guaranteed to be operational at 1.8V supply voltage, for temperatures between  $0^\circ\text{C}$  and  $125^\circ\text{C}$ . This makes the LMV791 ideal for usage in low-voltage commercial applications.

#### RRO and Ground Sensing

Rail-to-rail output swing provides maximum possible dynamic range at the output. This is particularly important when operating at low supply voltages. An innovative positive feedback scheme is used to boost the current drive capability of the output stage. This allows the LMV791 to source more than 40 mA of current at 1.8V supply. This also limits the performance of the LMV791 as a comparator, and hence the usage of LMV791 in an open-loop configuration is not recommended. The input common-mode range includes the negative supply rail which allows direct sensing at ground in single supply operation.

#### Enable and Shutdown Features

The LMV791 is ideal for battery powered systems. With a low supply current of 1.15 mA and a shutdown current typically less than  $1 \mu\text{A}$ , it allows the designer to maximize battery life. The enable pin of the LMV791 allows the op amp to be turned off and reduce its supply current to less than  $1 \mu\text{A}$ . To power on the op amp the enable pin should be higher than  $V^+ - 0.5\text{V}$ , where  $V^+$  is the positive supply. To disable the op amp, the enable pin should be lesser than  $V^- + 0.5\text{V}$ , where  $V^-$  is the negative supply.

#### Small Size

The small footprint of the LMV791 package saves space on printed circuit boards, and enables the design of smaller electronic products, such as cellular phones, pagers, or other portable systems. Signals can pick up noise between the signal source and the amplifier. By using a physically smaller amplifier package, the LMV791 can be placed closer to the signal source, reducing noise pickup and increasing signal integrity.

### CAPACITIVE LOAD TOLERANCE

The LMV791 can directly drive 120 pF in unity-gain without oscillation. The unity-gain follower is the most sensitive configuration to capacitive loading. Direct capacitive loading reduces the phase margin of amplifiers. The combination of the amplifier's output impedance and the capacitive load induces phase lag. This results in either an underdamped pulse response or oscillation. To drive a heavier capacitive load, the circuit in *Figure 1* can be used.

In *Figure 1*, the isolation resistor  $R_{\text{ISO}}$  and the load capacitor  $C_L$  form a pole to increase stability by adding more phase margin to the overall system. The desired performance depends on the value of  $R_{\text{ISO}}$ . The bigger the  $R_{\text{ISO}}$  resistor value, the more stable  $V_{\text{OUT}}$  will be. Increased  $R_{\text{ISO}}$  would, however, result in a reduced output swing and short circuit current.

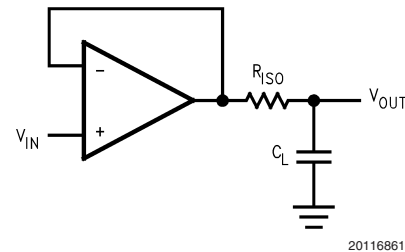

FIGURE 1.

### INPUT CAPACITANCE AND FEEDBACK CIRCUIT ELEMENTS

The LMV791 has a very low input bias current (50 fA) and a low  $1/f$  noise corner frequency (400 Hz), which makes it ideal for sensor applications. However, to obtain this performance a large CMOS input stage is used, which adds to the input capacitance. Though this does not affect the DC and low frequency performance, at higher frequencies the input capacitance interacts with the input and the feedback impedances to create a pole, which results in lower phase margin and gain peaking. This can be controlled by being selective in the use of feedback resistors, as well as by using a feedback capacitance. For example, in the non-inverting amplifier shown in *Figure 2*, if  $C_{\text{IN}}$  and  $C_{\text{F}}$  are ignored and the open loop gain of the op amp is considered infinite then the gain of the circuit is  $-R_2/R_1$ . An op amp, however, usually has a dominant pole, which causes its gain to drop with frequency. Hence, this gain is only valid for DC and low frequency. To understand the effect of the input capacitance coupled with the non-ideal gain of the op amp, the circuit needs to be analyzed in the frequency domain using a Laplace transform.

Application Notes (Continued)

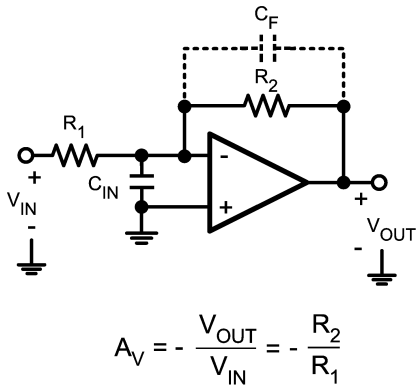

FIGURE 2.

For simplicity, the op amp is modelled as an ideal integrator with a unity gain frequency of  $A_0$ . Hence, its transfer function (or gain) in the frequency domain is  $A_0/s$ . Solving the circuit equations in the frequency domain, ignoring  $C_F$  for the moment, results in an expression for the gain shown in Equation (1).

$$\frac{V_{OUT}}{V_{IN}}(s) = \frac{-R_2/R_1}{\left[ 1 + \frac{s}{\left( \frac{A_0 R_1}{R_1 + R_2} \right)} + \frac{s^2}{\left( \frac{A_0}{C_{IN} R_2} \right)} \right]} \quad (1)$$

It can be inferred from the denominator of the transfer function that it has two poles, whose expressions can be obtained by solving for the roots of the denominator and are shown in Equation (2)

$$P_{1,2} = \frac{-1}{2C_{IN}} \left[ \frac{1}{R_1} + \frac{1}{R_2} \pm \sqrt{\left( \frac{1}{R_1} + \frac{1}{R_2} \right)^2 - \frac{4 A_0 C_{IN}}{R_2}} \right] \quad (2)$$

Equation (2) shows that as the values of  $R_1$  and  $R_2$  are increased, the magnitude of the poles, and hence the bandwidth of the amplifier, is reduced. This theory is verified by using different values of  $R_1$  and  $R_2$  in the circuit shown in Figure 1 and by comparing their frequency responses. In Figure 3 the frequency responses for three different values of  $R_1$  and  $R_2$  are shown. When both  $R_1$  and  $R_2$  are 1 k $\Omega$ , the response is flattest and widest; whereas, it narrows and peaks significantly when both their values are changed to 10 k $\Omega$  or 30 k $\Omega$ . So it is advisable to use lower values of  $R_1$  and  $R_2$  to obtain a wider and flatter response. Lower resistances also help in high sensitivity circuits since they add less noise.

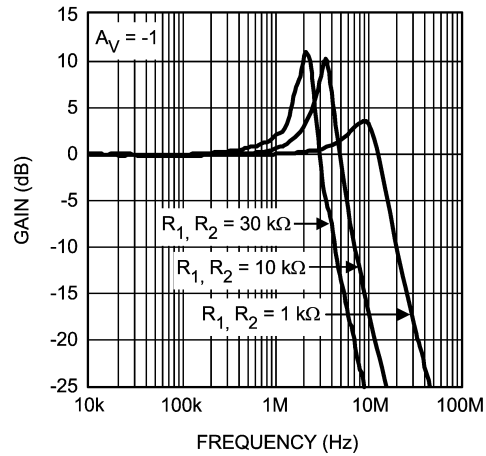

FIGURE 3.

A way of reducing the gain peaking is by adding a feedback capacitance  $C_F$  in parallel with  $R_2$ . This introduces another pole in the system and prevents the formation of pairs of complex conjugate poles which cause the gain to peak. Figure 4 shows the effect of  $C_F$  on the frequency response of the circuit. Adding a capacitance of 2 pF removes the peak, while a capacitance of 5 pF creates a much lower pole and reduces the bandwidth excessively.

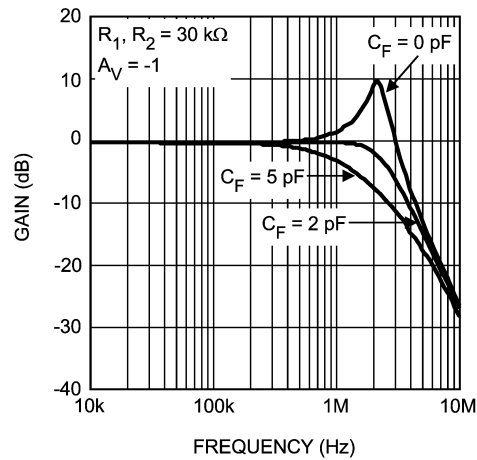

FIGURE 4.

AUDIO PRE-AMPLIFIER WITH BANDPASS FILTERING

With low input referred voltage noise, low supply voltage and low supply current, and a low harmonic distortion, the LMV791 is ideal for audio applications. Its wide unity gain bandwidth allows it to provide large gain for a wide range of frequencies and it can be used to design a pre-amplifier to drive a load of as low as 600 $\Omega$  with less than 0.01% distortion. Two amplifier circuits are shown in Figure 5 and Figure 6. Figure 5 is an inverting amplifier and provides a gain of -10, while Figure 6 is a non-inverting amplifier and provides a gain of 11. In either of these circuits, the coupling capacitor  $C_{C1}$  decides the lower frequency at which the circuit starts providing gain, while the feedback capacitor  $C_F$  decides the

### Application Notes (Continued)

frequency at which the gain starts dropping off. *Figure 7* shows the frequency response of the inverting amplifier with different values of  $C_F$ .

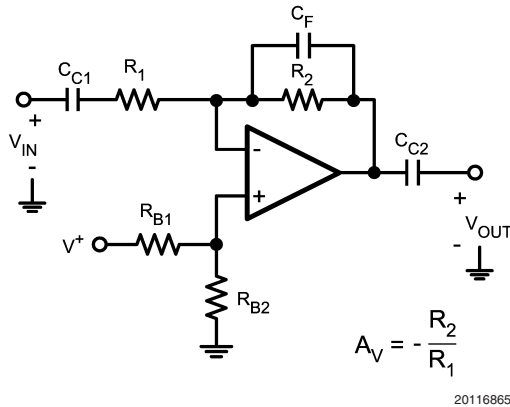

FIGURE 5.

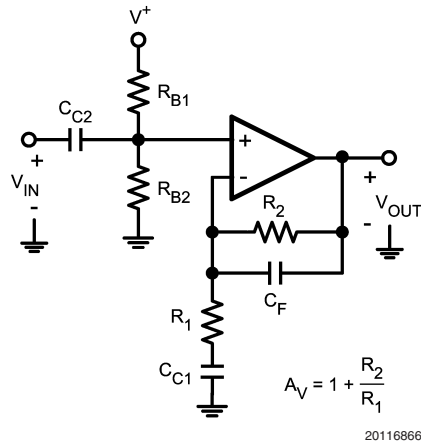

FIGURE 6.

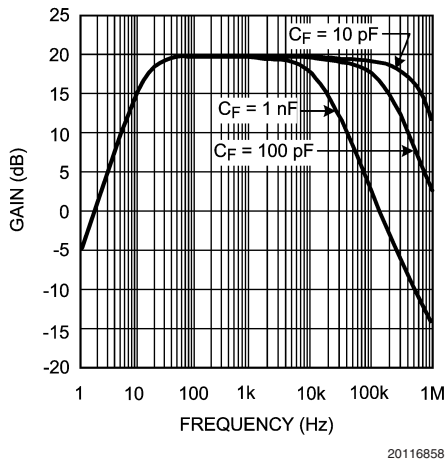

FIGURE 7.

### TRANSIMPEDANCE AMPLIFIER

With a wide bandwidth, low input bias current and low input voltage and current noise, the LMV791 is ideal for wideband transimpedance applications. *Figure 8* shows a photodiode transimpedance amplifier used in a number of applications such as barcode scanners, light meters, fiber optic receivers and industrial sensors. The key components are a photodiode, an op amp and a feedback resistor  $R_F$ . The voltage around the photodiode is kept constant to avoid non-linearities. The op amp converts the current flowing into the resistor  $R_F$  into a voltage at its output, and hence provides the transimpedance gain.

An interesting aspect of this type of amplifiers, also known as I-V converters, is that in most cases the frequency response of the circuit needs to be modified to prevent oscillations. The capacitance at the input of the op amp includes the diode parasitic capacitance  $C_D$  as well as the op amp common-mode capacitance  $C_{CM}$ . This high capacitance combines with a large  $R_F$ , needed for a reasonable transimpedance gain, to create a phase shift around the loop, which results in oscillation at high frequencies.

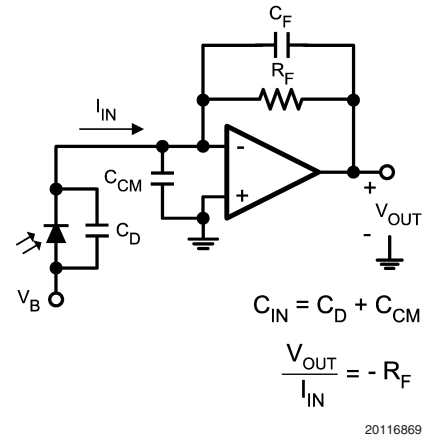

FIGURE 8. Photodiode Transimpedance Amplifier

A feedback capacitance  $C_F$  is usually added in parallel with  $R_F$  to maintain circuit stability and control the frequency response. To achieve a maximally flat, 2nd-order Butterworth response, the feedback pole ( $R_F$  and  $C_F$ ) should be set using *Equation (3)*.

$$C_F = \sqrt{\frac{C_{IN}}{GBWP * 2 \pi R_F}} \tag{3}$$

Calculating  $C_F$  from *Equation (3)* can sometimes return unreasonably small values ( $< 2$  pF), especially for high speed applications. In these cases, its often more practical to use the circuit shown in *Figure 9* in order to allow more reasonable values. The new value of  $C'_F$  is  $(1 + R_B/R_A) C_F$ . This relationship holds as long as  $R_A \ll R_F$ .

**Application Notes** (Continued)

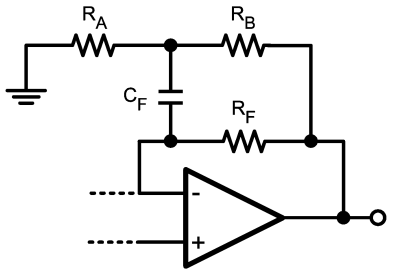

IF  $R_A \ll R_F$   
 $C_F' = \left(1 + \frac{R_B}{R_A}\right) C_F$

20116871

**FIGURE 9.**

**SENSOR INTERFACES**

LMV791's low input bias current and low input referred noise make it an ideal part for sensor interfaces. These circuits are required to sense voltages of the order of a few  $\mu V$ , and currents amounting to less than a nA, and hence the op amp

needs to have low voltage noise and low input bias current. Typical applications include Infra-red (IR) thermometry, thermocouple amplifiers and pH electrode buffers. *Figure 10* is an example of a typical circuit used for measuring IR radiation intensity, often used for estimating the temperature of an object from a distance. The IR sensor generates a voltage proportional to  $I$ , the intensity of the IR radiation falling on it. The resistance  $R_A$  and  $R_B$  are selected to provide a high gain to amplify this voltage, while  $C_F$  is added to filter out the high frequency noise.

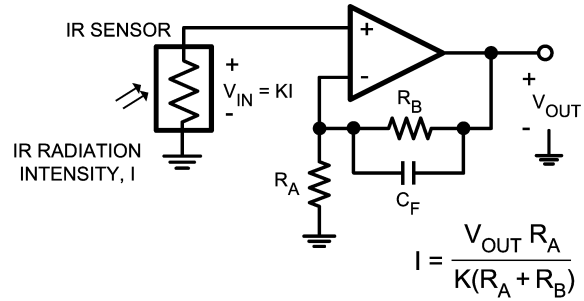

$$I = \frac{V_{OUT} R_A}{K(R_A + R_B)}$$

20116872

**FIGURE 10. IR Radiation Sensor**

**Physical Dimensions** inches (millimeters) unless otherwise noted

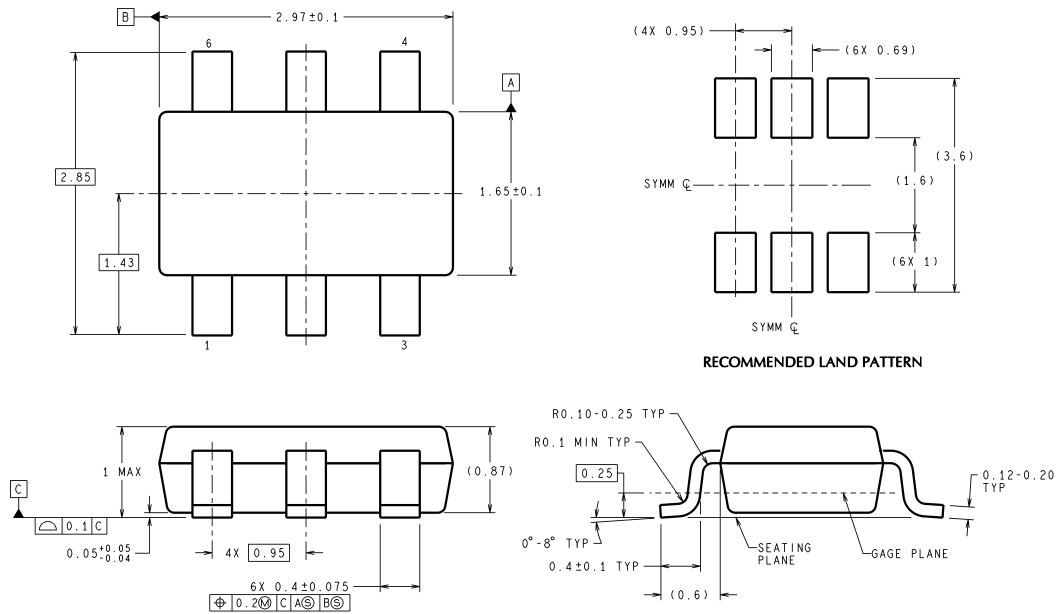

DIMENSIONS ARE IN MILLIMETERS

MK06A (Rev D)

**6-Pin TSOT23  
NS Package Number MK06A**

National does not assume any responsibility for use of any circuitry described, no circuit patent licenses are implied and National reserves the right at any time without notice to change said circuitry and specifications.

For the most current product information visit us at [www.national.com](http://www.national.com).

**LIFE SUPPORT POLICY**

NATIONAL'S PRODUCTS ARE NOT AUTHORIZED FOR USE AS CRITICAL COMPONENTS IN LIFE SUPPORT DEVICES OR SYSTEMS WITHOUT THE EXPRESS WRITTEN APPROVAL OF THE PRESIDENT AND GENERAL COUNSEL OF NATIONAL SEMICONDUCTOR CORPORATION. As used herein:

1. Life support devices or systems are devices or systems which, (a) are intended for surgical implant into the body, or (b) support or sustain life, and whose failure to perform when properly used in accordance with instructions for use provided in the labeling, can be reasonably expected to result in a significant injury to the user.
2. A critical component is any component of a life support device or system whose failure to perform can be reasonably expected to cause the failure of the life support device or system, or to affect its safety or effectiveness.

**BANNED SUBSTANCE COMPLIANCE**

National Semiconductor manufactures products and uses packing materials that meet the provisions of the Customer Products Stewardship Specification (CSP-9-111C2) and the Banned Substances and Materials of Interest Specification (CSP-9-111S2) and contain no "Banned Substances" as defined in CSP-9-111S2.

Leadfree products are RoHS compliant.

 **National Semiconductor**  
Americas Customer  
Support Center  
Email: [new.feedback@nsc.com](mailto:new.feedback@nsc.com)  
Tel: 1-800-272-9959

**National Semiconductor**  
Europe Customer Support Center  
Fax: +49 (0) 180-530 85 86  
Email: [europe.support@nsc.com](mailto:europe.support@nsc.com)  
Deutsch Tel: +49 (0) 69 9508 6208  
English Tel: +44 (0) 870 24 0 2171  
Français Tel: +33 (0) 1 41 91 8790

**National Semiconductor**  
Asia Pacific Customer  
Support Center  
Email: [ap.support@nsc.com](mailto:ap.support@nsc.com)

**National Semiconductor**  
Japan Customer Support Center  
Fax: 81-3-5639-7507  
Email: [jpn.feedback@nsc.com](mailto:jpn.feedback@nsc.com)  
Tel: 81-3-5639-7560

[www.national.com](http://www.national.com)