

## 20V N-Channel Enhancement-Mode MOSFET

### ● APPLICATIONS

- 1) High Density Cell Design For Ultra Low On-Resistance  
Improved Shoot-Through FOM
- 2) We declare that the material of product compliant with RoHS requirements and Halogen Free

### ● FEATURES

- V<sub>DS</sub> = 20V
- R<sub>DS(ON)</sub>, V<sub>GS</sub>@4.5V, I<sub>DS</sub>@2.8A = 60mΩ
- R<sub>DS(ON)</sub>, V<sub>GS</sub>@2.5V, I<sub>DS</sub>@2.0A = 115mΩ

### ● DEVICE MARKING AND ORDERING INFORMATION

Device	Marking	Shipping
LN2302LT1G	N02	3000/Tape&Reel
LN2302LT3G	N02	10000/Tape&Reel

### ● MAXIMUM RATINGS(T<sub>a</sub> = 25°C)

Parameter	Symbol	Limits	Unit
Drain-to-Source Voltage	V <sub>DSS</sub>	20	V
Gate-to-Source Voltage	V <sub>GS</sub>	±8	V
Continuous Drain Current	I <sub>D</sub>	2.3	A
Pulsed Drain Current (Note1)	I <sub>DM</sub>	8	A
Maximum Power Dissipation	P <sub>D</sub>	T <sub>A</sub> = 25°C	0.9
		T <sub>A</sub> = 75°C	0.57
Operating and Storage Temperature Range	T <sub>J</sub> , T <sub>stg</sub>	-55 to +150	°C
Junction to Ambient Thermal Resistance(PCB mounted)(Note 2)	R <sub>θJA</sub>	145	°C/W

1. Repetitive Rating: Pulse width limited by the Maximum junction temperature
2. 1-in2 2oz Cu PCB board

### LN2302LT1G

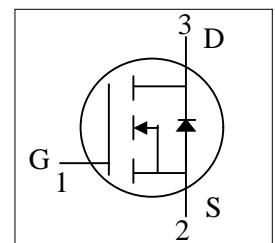
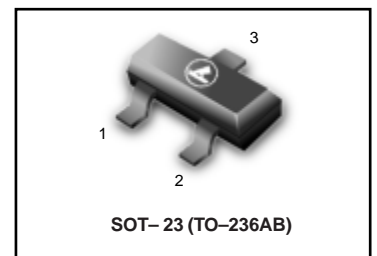

# LN2302LT1G

● ELECTRICAL CHARACTERISTICS (Ta= 25°C)  
STATIC

Parameter	Symbol	Min.	Typ.	Max.	Unit	Conditions
Drain-to-Source Breakdown Voltage	V(BR)DSS	20	–	–	V	VGS = 0 V, ID = 250 μA
Gate Threshold Voltage	VGS(TH)	0.6	0.95	1.2	V	VGS = VDS, ID = 250 μA
Zero Gate Voltage Drain Current	IDSS	–	–	-1	μA	VDS=9.6V, VGS=0V
Gate-to-Source Leakage Current	IGSS	–	–	±100	nA	VDS = 0 V, VGS = ±8 V
Drain-to-Source On Resistance	RDS(on)	–	40	60	mΩ	VGS = 4.5 V, ID =2.8 A
		–	50	115	mΩ	VGS = 2.5 V, ID = 2 A
Forward Diode Voltage	VSD			1.2	V	VGS = 0 V, ISD = -1.6A
Forward Transconductance	gFS	–	6.5	–	S	VDS = 5.0 V, ID = 4 A

DYNAMIC(Note 3)

Input Capacitance	Ciss	–	427.12	–	pF	VGS = 0 V, f = 1.0 MHz, VDS= 6 V
Output Capacitance	Coss	–	80.56	–		
Reverse Transfer Capacitance	Crss	–	57.00	–		
Total Gate Charge	QG	–	3.69	–	nC	VGS =4.5 V, VDS = 6 V ID = 2.8 A
Gate-to-Source Gate Charge	QGS	–	0.70	–		
Gate-to-Drain Charge	QGD	–	1.06	–		
Turn-On Delay Time	td(on)	–	6.16	–	ns	VDD = 6V, RL = 6 Ω ID = 1A, VGEN = 4.5V RG = 6 Ω
Rise Time	tr	–	7.56	–		
Turn-Off Delay Time	td(off)	–	16.61	–		
Fall Time	tf	–	4.07	–		

3.Pulse test: pulse width ≅ 300us, duty cycle ≅ 2%

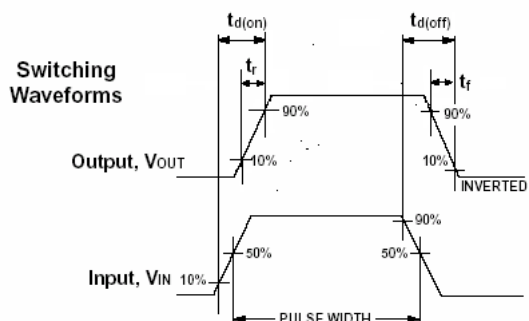
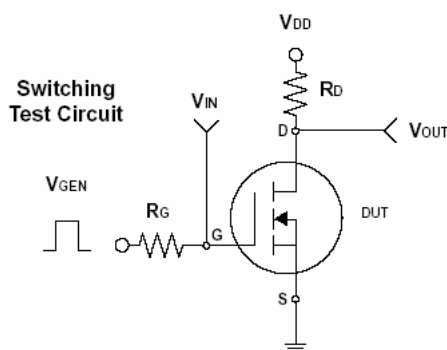

# LN2302LT1G

## ELECTRICAL CHARACTERISTIC CURVES

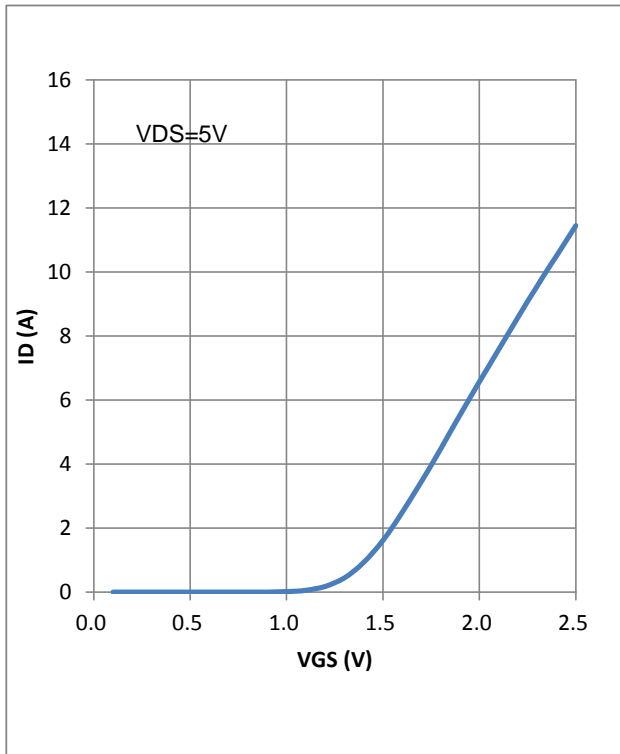

FIG.1 Transfer Characteristics

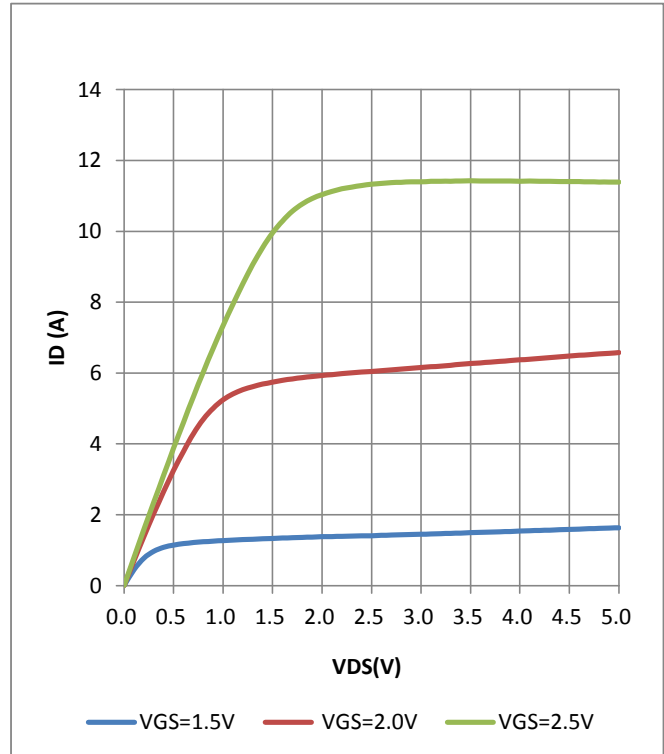

FIG.2 On-Region Characteristics

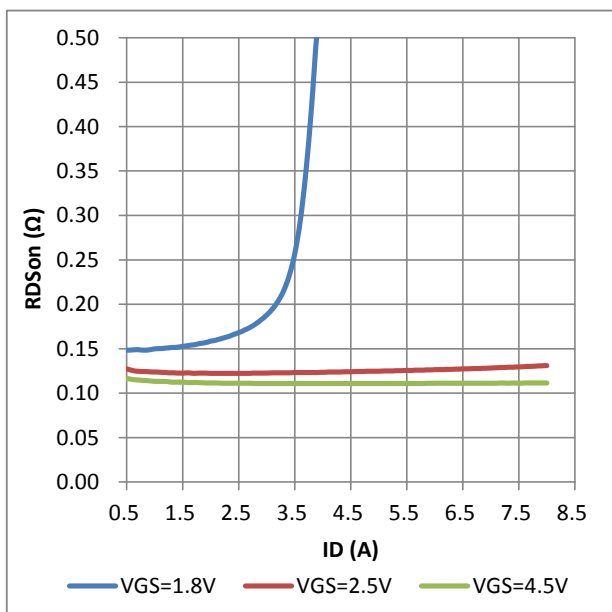

FIG.3 On-Resistance vs. Drain Current

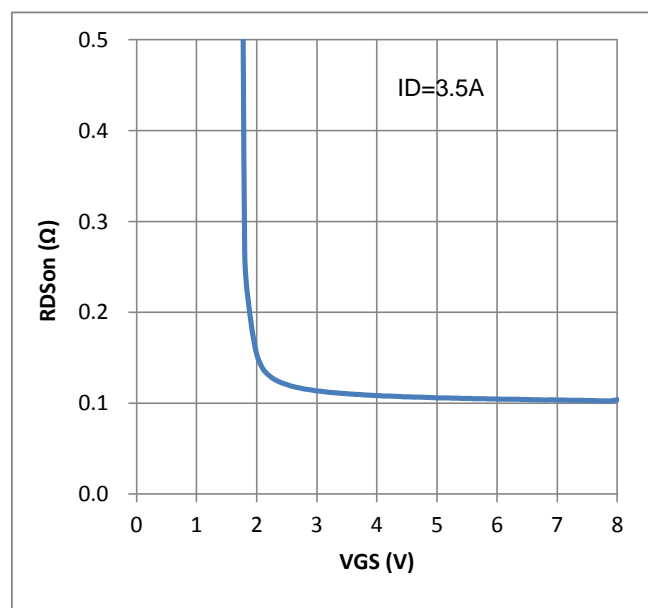

FIG.4 On-Resistance vs. Gate-to-Source Voltage

**LN2302LT1G****ELECTRICAL CHARACTERISTIC CURVES**

FIG.7 On-Resistance vs. Junction Temperature

FIG.8  $V_{TH}$  vs. Junction Temperature

# LN2302LT1G

## SOT-23

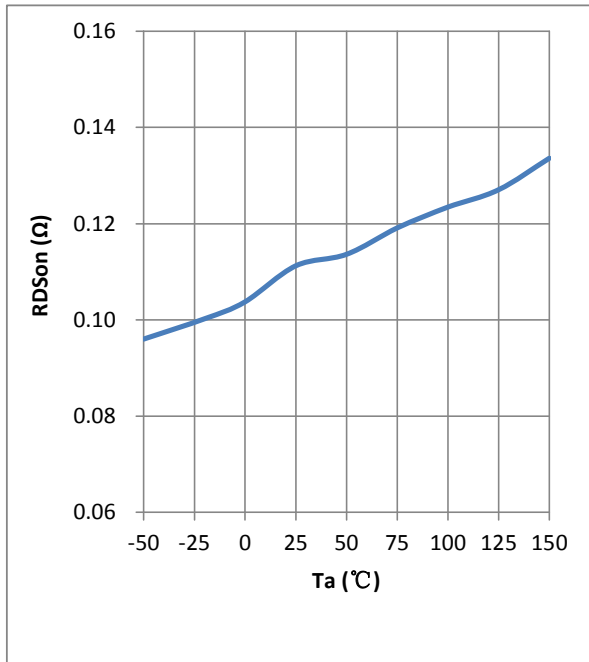
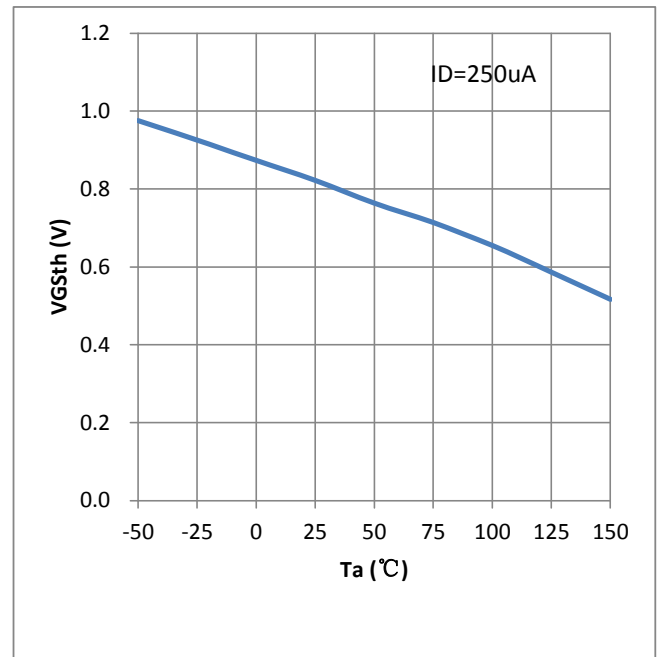
NOTES:

1. DIMENSIONING AND TOLERANCING PER ANSI Y14.5M,1982
2. CONTROLLING DIMENSION: INCH.

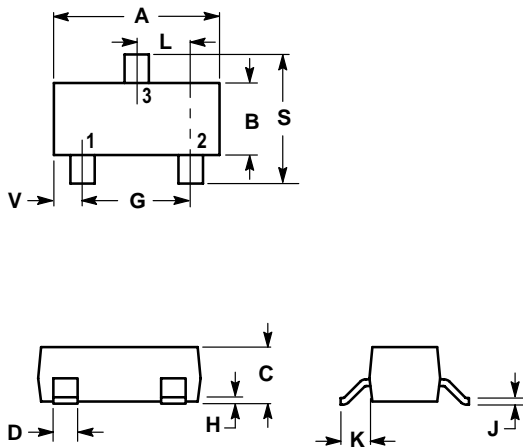

DIM	INCHES		MILLIMETERS	
	MIN	MAX	MIN	MAX
A	0.1102	0.1197	2.80	3.04
B	0.0472	0.0551	1.20	1.40
C	0.0350	0.0440	0.89	1.11
D	0.0150	0.0200	0.37	0.50
G	0.0701	0.0807	1.78	2.04
H	0.0005	0.0040	0.013	0.100
J	0.0034	0.0070	0.085	0.177
K	0.0140	0.0285	0.35	0.69
L	0.0350	0.0401	0.89	1.02
S	0.0830	0.1039	2.10	2.64
V	0.0177	0.0236	0.45	0.60

