

Low Current Consumption, High Sensitivity CMOS Hall IC

General Description

The LN4913 is an integrated hall-effect sensor designed specifically to meet the requirements of low-power devices. e.g. as an On/Off switch in Cellular Flip-Phones, with battery operating voltages of 1.65V-5.5V.

Precise magnetic switching points and high temperature stability are achieved through the unique design of the internal circuit. An onboard clock scheme is used to reduce the average operating current of the IC. During the operate phase the IC compares the actual magnetic field detected with the internally compensated switching points. The output Voltage is switched at the end of each operating phase. During the Stand-by phase the output stage is latched and the current consumption of the device reduced to some μA .

The IC switching behavior is Omni polar; it can be switched on with either the North or South pole of a magnet.

Typical Application Circuit

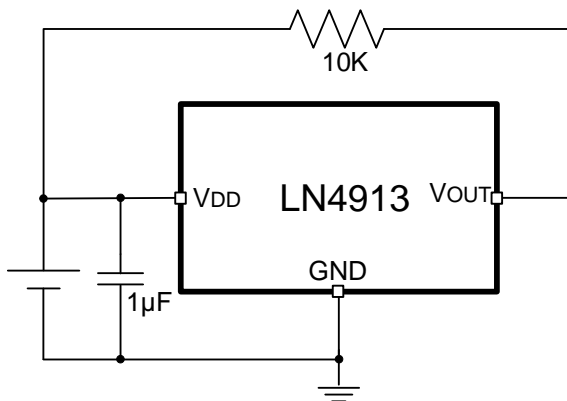

Ordering Information

Part Number	Package Code	Package	Lot Number	Part Number	Package Code	Package	Lot Number
LN4913MR	M	SOT-23-3	13XY	LN4913SRB	S	TO-92S	XXXX
LN4913NR	N	TSOT-23-3	13XY	LN4913ZRA	Z	DFN2015-6	13XY
LN4913TR	T	TO-92S	XXXX	LN4913LR	L	DFN2*2-3	13XY
LN4913SRA	S	TO-92S	XXXX				

Applications

- Cover switch in clam-shell cellular phones
- Cover switch in Notebook PC/PDA
- Contact-less switch in consumer products

Features

- Micro power design
- 1.65 V to 5.5 V battery operation
- High sensitivity and high stability of the magnetic switching points
- High resistance to mechanical stress
- Digital output signal
- Switching for both poles of a magnet (omnipolar)
- Not suitable for automotive application

Package

- SOT-23-3
- TSOT-23-3
- TO-92S
- DFN2015-6
- DFN2*2-3

Pin Configuration

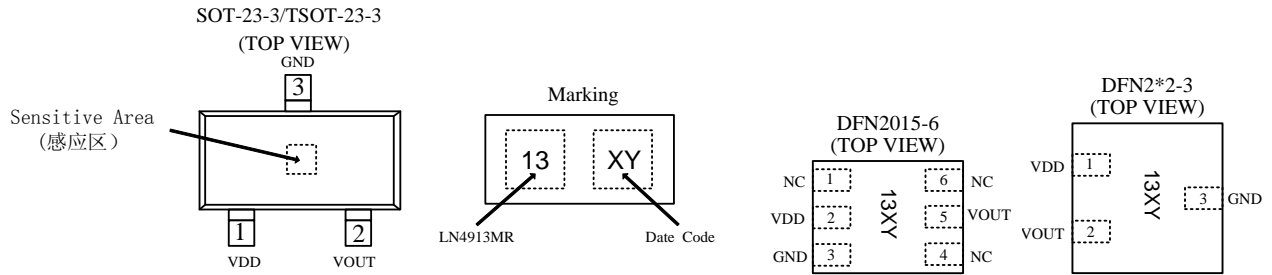

Pin Number			Pin Name	Function Description
SOT-23-3/TSOT-23-3	DFN2015-6	DFNWB2x2-3L		
2	5	2	VOUT	Output Pin
3	3	3	GND	Ground
1	2	1	VDD	Supply Voltage
-	4,6	-	NC	No Connection

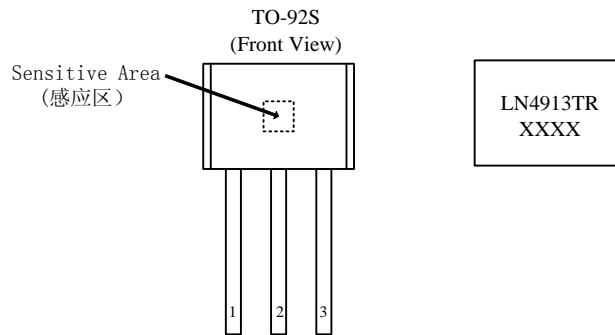

Ordering Name	Package	Pin Name			Marking
		1	2	3	
LN4913TR	TO-92S	VDD	VOUT	GND	4913
LN4913SRA	TO-92S	VOUT	GND	VDD	4913A
LN4913SRB	TO-92S	VDD	GND	VOUT	4913B

Function Block Diagram

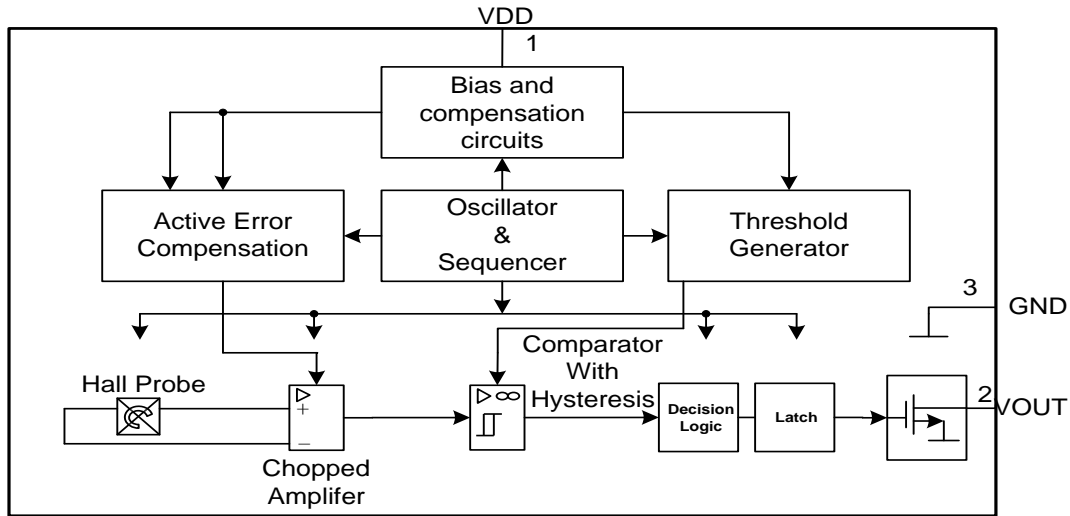

Absolute Maximum Ratings

Symbol	Characteristics	Values	Unit
V_{DD}	Supply voltage	-0.3-6.0	V
I_{DD}	Operating current	-1-4.5	mA
V_{OUT}	Output voltage	-0.3-6.0	V
I_{OUT}	Output current	-1-2.0	mA
T_s	Storage temperature range	-40~+150	°C
T_J	Maximum junction temperature	150	°C
-	ESD Protection	4000	V

Electrical Characteristics

AC/DC Characteristics ($T_A=+25^\circ\text{C}$, $V_{DD}=3.0\text{V}$, Unless otherwise specified)

Symbol	Characteristic	Conditions	Min	Type	Max	Unit
V_{DD}	Supply voltage	—	1.65	—	6.0	V
I_{SAVG}	Averaged supply current		1	3	10	uA
I_{SOPAVG}	Averaged current during operating time		0.5	2.0	3.5	mA
I_{SOPT}	Peak current during operating time				4.5	mA
I_{SSTB}	Supply current during standby time		1	1.9	8	uA
V_{QSAT}	Output Saturation Voltage	$I_Q=1\text{mA}$		0.13	0.4	V
I_{QLEAK}	Output on Leakage Current			0.01	1	uA
t_r	Output rise time	$R_L=2.7\text{K}\Omega$ $C_L=10\text{pF}$		0.5	1	us
t_f	Output fall time	$R_L=2.7\text{K}\Omega$ $C_L=10\text{pF}$		0.1	1	us
t_{op}	Operating time		25	100	160	us
t_{stb}	Standby time		60	140	240	ms
t_{op}/t_{stb}	Duty cycle			0.071		%
t_{stu}	Start-up time of IC			12	20	us

■ Magnetic Characteristics

($T_A=+25^{\circ}\text{C}$, $V_{DD}=2.7\text{V}$, Unless otherwise specified)

Symbol	Min	Type	Max	Unit
BOPS	2	3.5	5	mT
BOPN	-5	-3.5	-2	mT
BRPS	1.2	2.7	4.2	mT
BRPN	-4.2	-2.6	-1.2	mT
BHYS	0.2	0.8	1.6	mT

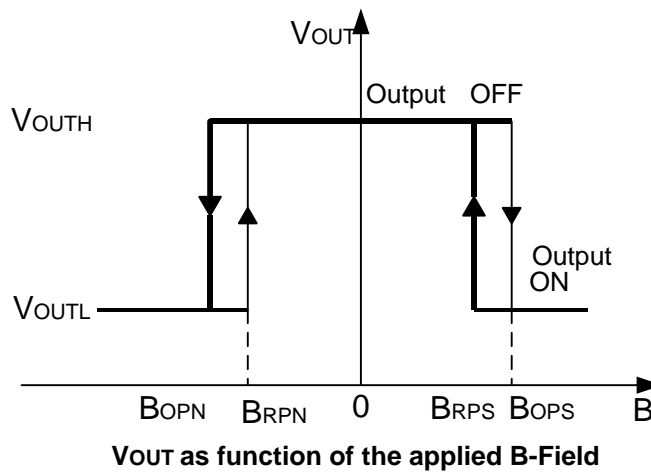
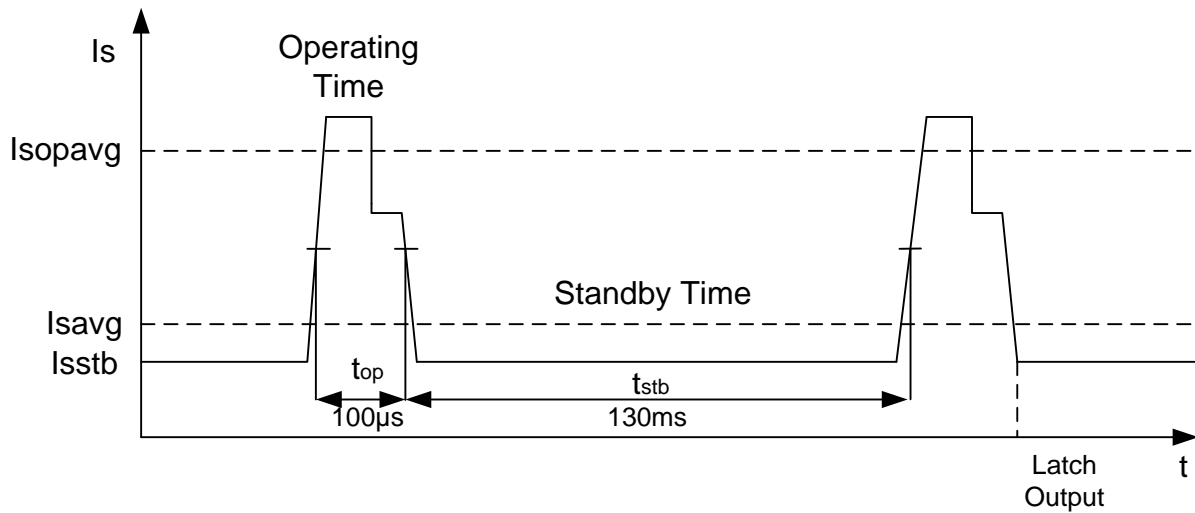

Typical Operating Characteristics

Vdd(V)=2.7V , Isopavg—TA

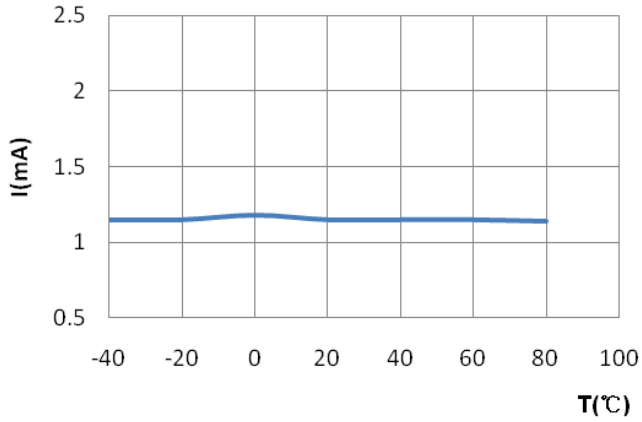

TA=20°C, Isopavg—Vdd

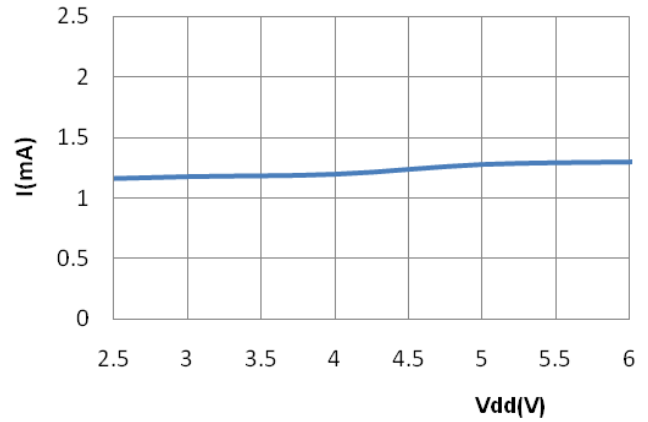

Vdd=2.7V, Issstb—TA

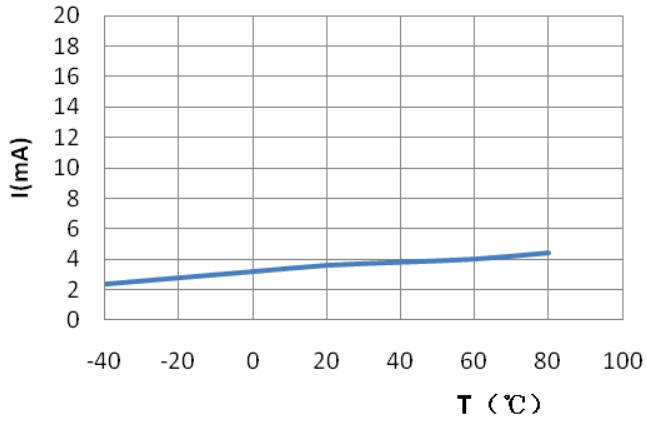

TA=20°C, Issstb—Vdd

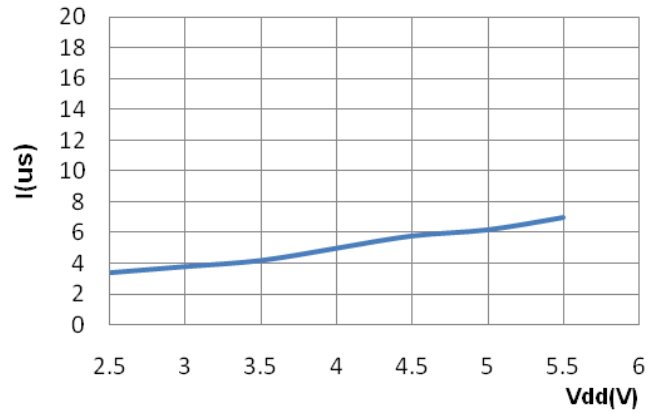

Iout =1mA , VQSAT—TA

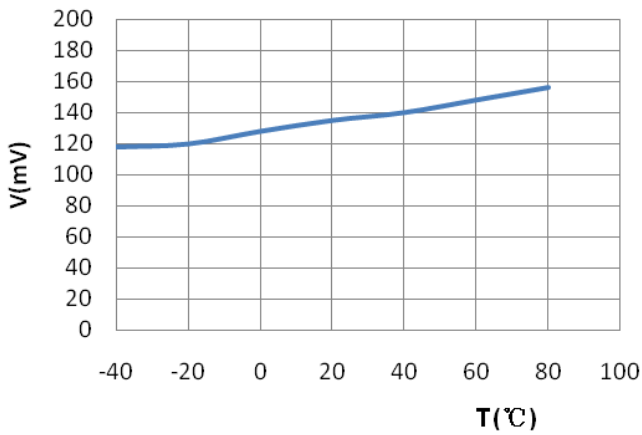

Vdd=2.7V, tstb—TA

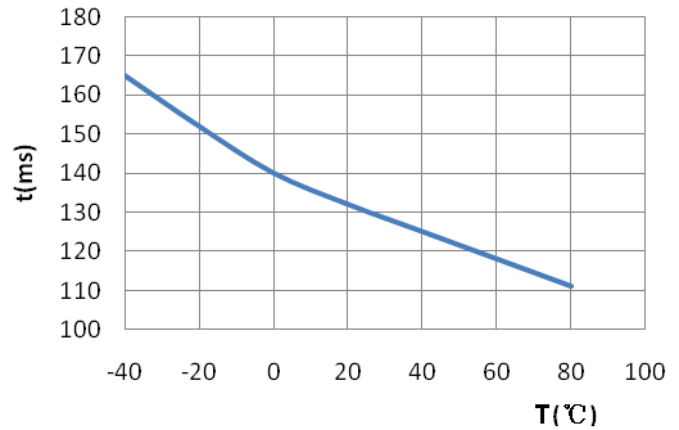

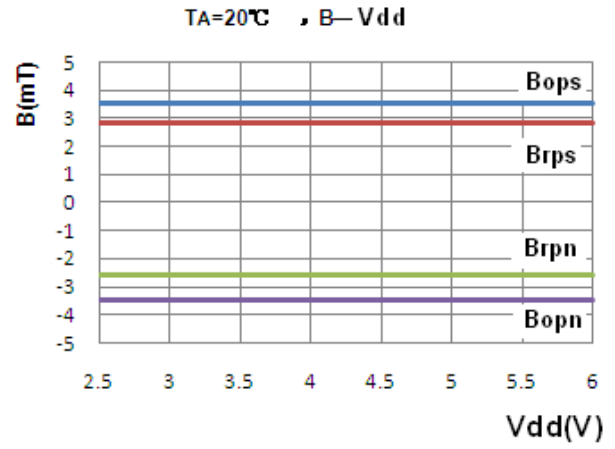
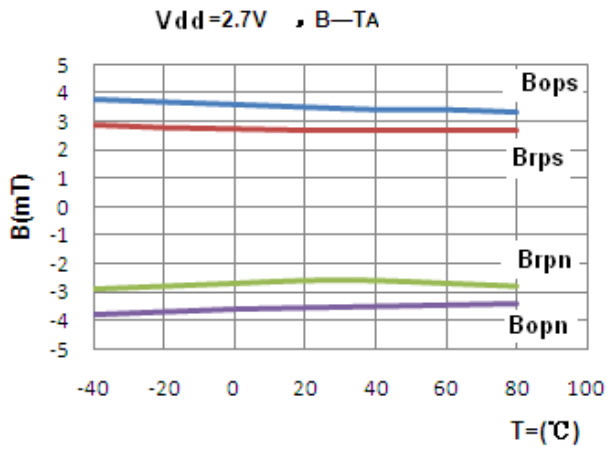

■ Package

- SOT-23-3

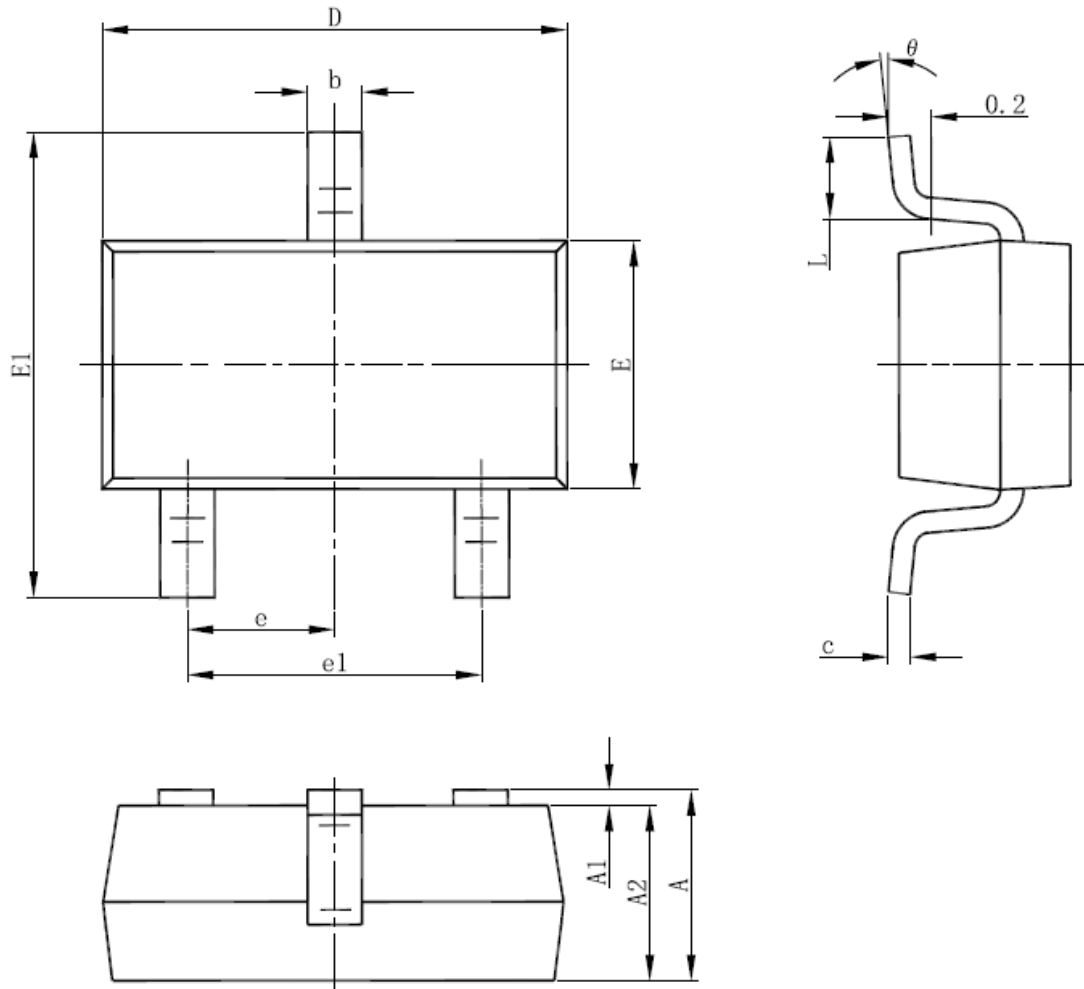

Symbol	Dimensions In Millimeters		Dimensions In Inches	
	Min	Max	Min	Max
A	1.050	1.250	0.041	0.049
A1	0.000	0.100	0.000	0.004
A2	1.050	1.150	0.041	0.045
b	0.300	0.500	0.012	0.020
c	0.100	0.200	0.004	0.008
D	2.820	3.020	0.111	0.119
E	1.500	1.700	0.059	0.067
E1	2.650	2.950	0.104	0.116
e	0.950(BSC)		0.037(BSC)	
e1	1.800	2.000	0.071	0.079
L	0.300	0.600	0.012	0.024
θ	0°	8°	0°	8°

● TSOT-23-3

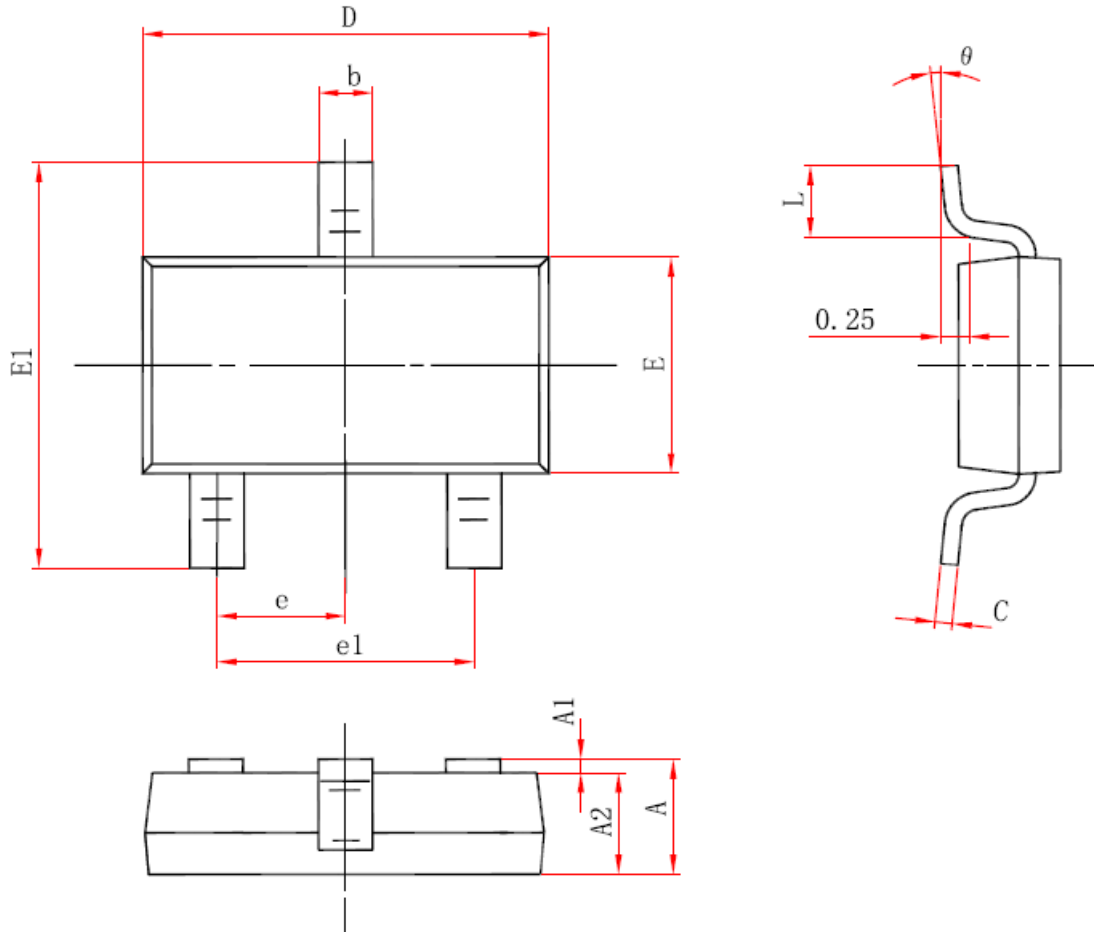

Symbol	Dimensions In Millimeters		Dimensions In Inches	
	Min	Max	Min	Max
A	0.700	0.900	0.028	0.035
A1	0.000	0.100	0.000	0.004
A2	0.700	0.800	0.028	0.031
b	0.350	0.500	0.014	0.020
c	0.080	0.200	0.003	0.008
D	2.820	3.020	0.111	0.119
E	1.600	1.700	0.063	0.067
E1	2.650	2.950	0.104	0.116
e	0.95 (BSC)		0.037(BSC)	
e1	1.90 (BSC)		0.075(BSC)	
L	0.300	0.600	0.012	0.024
theta	0°	8°	0°	8°

• TO-92S

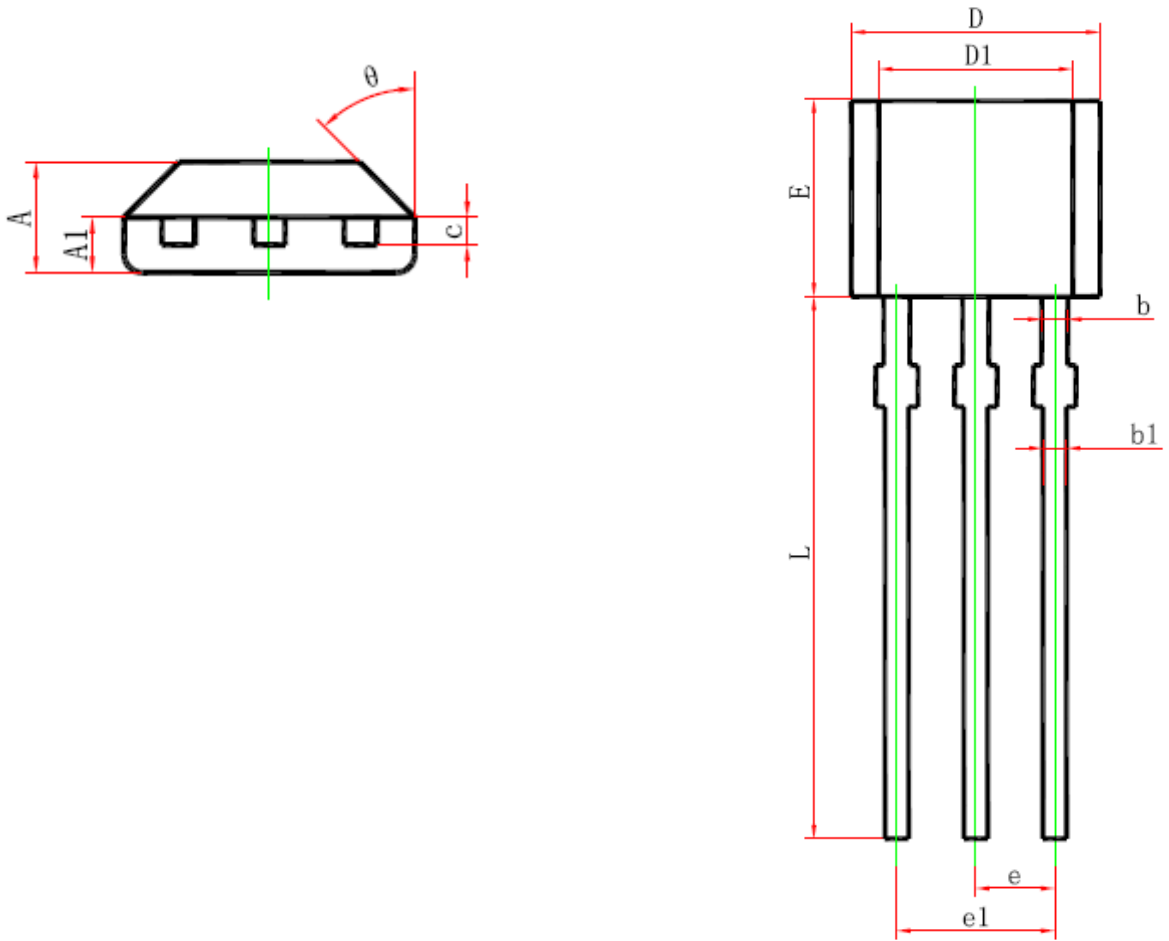

Symbol	Dimensions In Millimeters		Dimensions In Inches	
	Min	Max	Min	Max
A	1.420	1.620	0.056	0.064
A1	0.660	0.860	0.026	0.034
b	0.420	0.550	0.017	0.022
b1	0.360	0.480	0.014	0.019
c	0.360	0.510	0.014	0.020
D	3.900	4.100	0.154	0.161
D1	2.970	3.270	0.117	0.129
E	3.050	3.250	0.120	0.128
e	1.270 TYP		0.050 TYP	
e1	2.440	2.640	0.096	0.104
L	15.100	15.500	0.594	0.610
θ	45° TYP		45° TYP	

● DFN2015-6

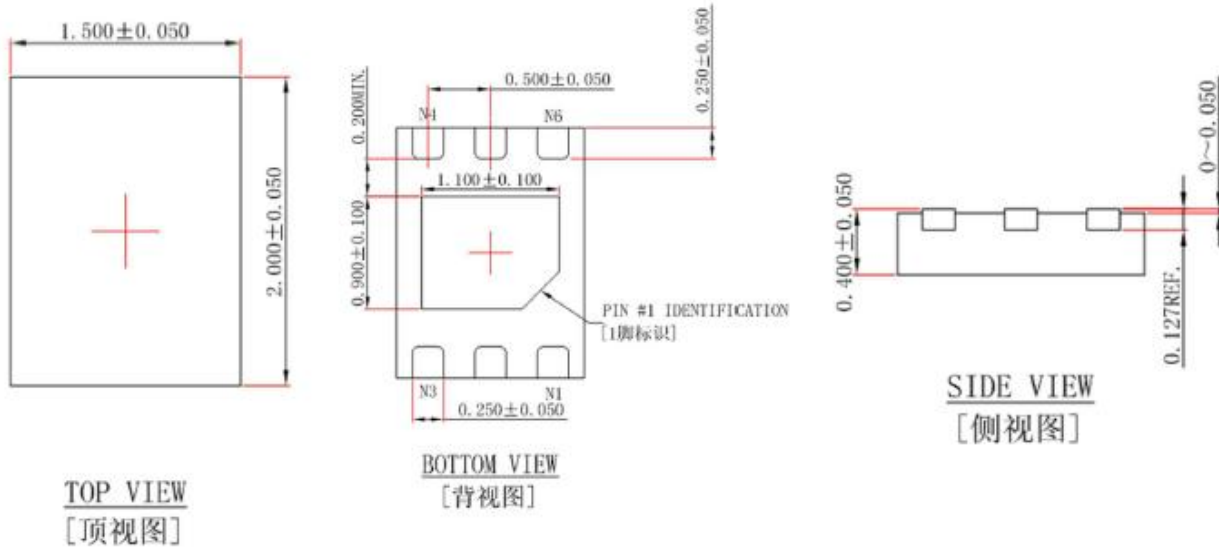

● DFN2*2-3

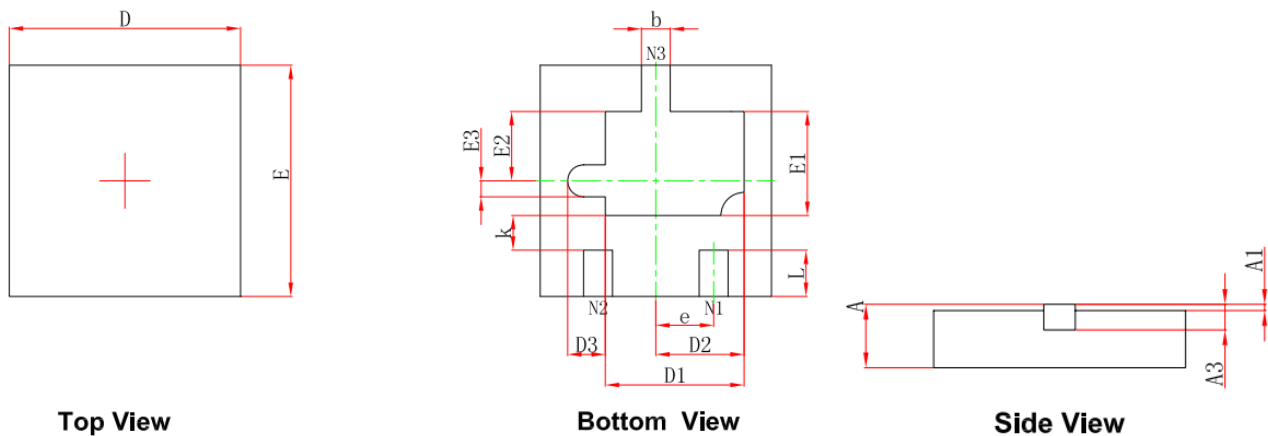

Symbol	Dimensions In Millimeters		Dimensions In Inches	
	Min.	Max.	Min.	Max.
A	0.450/0.550	0.550/0.650	0.018/0.022	0.022/0.026
A1	0.000	0.050	0.000	0.002
A3	0.152REF.		0.006REF.	
D	1.924	2.076	0.076	0.082
E	1.924	2.076	0.076	0.082
D1	1.100	1.300	0.043	0.051
D2	0.763REF.		0.030REF.	
D3	0.325REF.		0.013REF.	
E1	0.800	1.000	0.031	0.039
E2	0.600REF.		0.024REF.	
E3	0.138REF.		0.005REF.	
k	0.200MIN.		0.008MIN.	
b	0.200	0.300	0.008	0.012
e	0.500TYP.		0.020TYP.	
L	0.324	0.476	0.013	0.019