

High Input Voltage & Low Power CMOS Voltage Regulators

■ General Description

The LN71XX series is a set of three-terminal middle current low voltage regulator implemented in CMOS technology. They can deliver 70mA output current and allow an input voltage as high as 28V. They are available with several fixed output voltages ranging from 1.8V to 5.0V. CMOS technology ensures low voltage drop and low quiescent current. Although designed primarily as fixed voltage regulators, these devices can be used with external components to obtain variable voltages and currents.

■ Applications

- Battery-powered equipment
- Communication equipment

■ Features

- Low power : 2.5 μ A (typ.)
- Highly Accurate: $\pm 2\%$ (max)
- Low voltage drop: 100mV @ $I_{out}=1mA$
- Low temperature coefficient : $< \pm 100ppm/^{\circ}C$
- High input voltage: 28V
- High input breakdown voltage: $\geq 40V$
- Internal protector current limiter and short protector
- Maximum output current : 70mA
- Little packages: TO-92, SOT-89-3L, SO-T23-3L, SOT-23-5L

■ Package

- TO-92
- SOT-89-3L
- SO-T23-3L
- SOT-23-5L

■ Typical Application Circuit

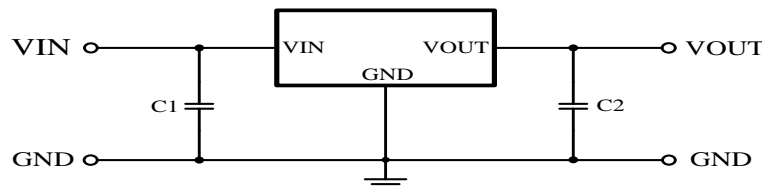

Note: $C_{IN}(C1) \geq 10\mu F$; $C_{OUT}(C2) \geq 10\mu F$.

■ Ordering Information

LN71 ①②③④

Item	Symbol	Description
① ②	18-50	Output voltage:Eg: ②=3, ③=0 represents 3.0V
③		Package type
	T	TO-92
	F	SOT-23-5L
	M	SOT-23-3L
④	P	SOT-89-3L
		Device orientation
	R	Embossed Tape: Standard Feed
	L	Embossed Tape: Reverse Feed

■ Pin Configuration

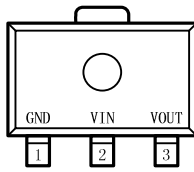

SOT-89-3L
(TOP VIEW)

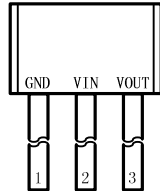

TO-92
(FRONT VIEW)

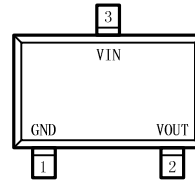

SOT-23-3L
(TOP VIEW)

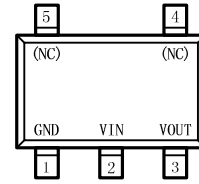

SOT-23-5L
(TOP VIEW)

■ Pin Assignment

Pin Number				Pin Name	Function Description
SOT-89-3L	TO-92	SOT-23-3L	SOT-23-5L		
1	1	1	1	GND	Ground
2	2	3	2	VIN	Power Input
3	3	2	3	VOUT	Output
			4	NC	NC
			5	NC	NC

■ Marking Rule

- SOT-89-3L、TO-92

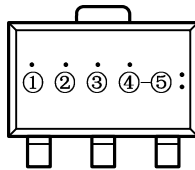

SOT-89-3L
(TOP VIEW)

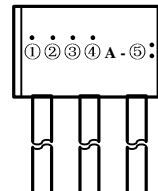

TO-92
(FRONT VIEW)

- ① ② Represents the product name

Symbol	Product Name
① ②	①②=71 LN71◆◆◆◆

- ③ ④ Represents the output voltage

Symbol	Product Name
③	④
Output volatge: Eg: ②=3, ③=0 represents 3.0V	

- ⑤ Represents the assembly lot no.

0~9, A~Z repeated (G, I, J, O, Q, W excepted)

● SOT23-3L、SOT23-5L

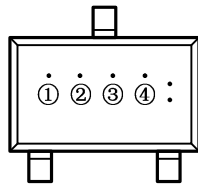

SOT-23-3L
(TOP VIEW)

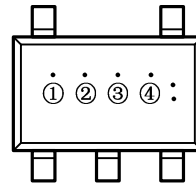

SOT-23-5L
(TOP VIEW)

① Represents the product name

Symbol	Product Name
①	①=1 LN71◆◆◆◆

② ③ Represents the output voltage

Symbol	Product Name
②	③
Output volatge: Eg: ②=3, ③=0 represents 3.0V	

④ Represents the assembly lot no.

0~9, A~Z repeated (G, I, J, O, Q, W excepted)

■ Function Block Diagram

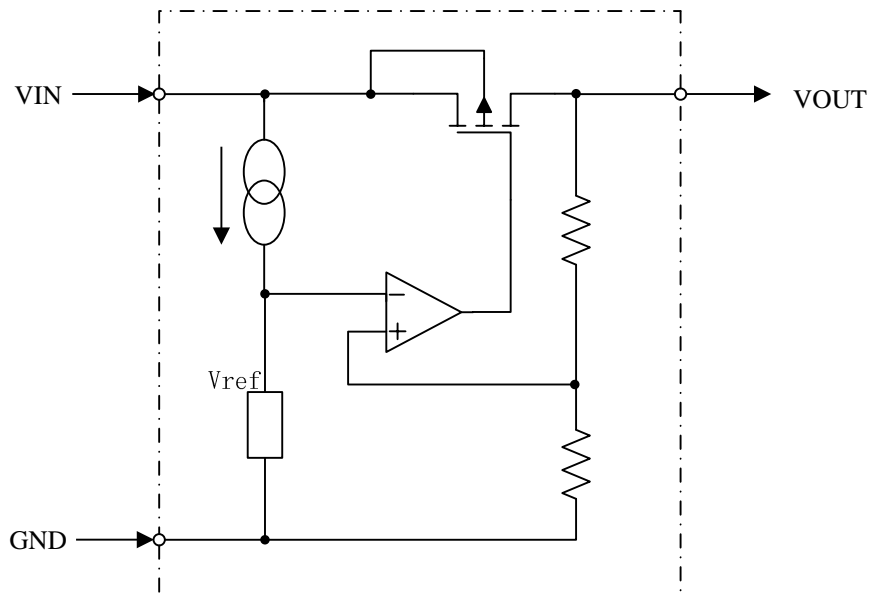

■ Absolute Maximum Ratings

Parameter		Symbol	Maximum Rating	Unit
Input Voltage		V _{in}	-0.3~28	V
Input breakdown voltage		V _{INBV}	40	V
Power Dissipation	SOT-89-3L	P _d	500	mW
	TO-92		300	
	SOT-23-3L		250	
	SOT-23-5L		250	
Operating Ambient Temperature		T _{opr}	-40~+85	°C
Storage Temperature		T _{stg}	-40~+125	°C

Caution: The absolute maximum ratings are rated values exceeding which the product could suffer physical damage. These values must therefore not be exceeded under any conditions.

■ Electrical Characteristics

 T_a=25°C

Symbol	Parameters	Test Conditions		Min.	Typ.	Max.	Unit
		V _{IN}	Conditions				
V _{OUT}	Output Voltage Tolerance	V _{OUT} +1V	I _{OUT} =10mA	0.98×V _{OUT}	V _{OUT} ^[1]	1.02×V _{OUT}	V
I _{OUT}	Output Current	V _{OUT} +1V	-	20	30	70	mA
ΔV _{OUT}	Load Regulation	V _{OUT} +1V	1mA≤I _{OUT} ≤20mA	-	60	100	mV
V _{DIF}	Voltage Drop	-	I _{OUT} =10mA	-	150	-	mV
I _{SS}	Current Consumption	V _{OUT} +1V	No Load	-	2.5	5	uA
$\frac{\Delta V_{OUT}}{\Delta V_{IN} \times V_{OUT}}$	Line Regulation	-	V _{OUT} +1V≤V _{IN} ≤24 I _{OUT} =1mA	-	0.2	-	%/V
V _{IN}	Input Voltage	-	-	-	-	28	V
V _{INBV}	Input breakdown voltage	-	-	40	-	-	V
$\frac{\Delta V_{OUT}}{\Delta T_a}$	Temperature Coefficient	V _{OUT} +1V	I _{OUT} =10mA 0°C≤T _a ≤70°C	-	$\pm 0.45 \times \frac{V_{OUT}}{3}$	-	mV/°C

Note[1]: "V_{OUT}" is the fixed output voltage. eg. "V_{OUT}" equal 3.0V for LN7130 and equal 5.0V for LN7150

■ Typical Performance Characteristics

1. Quiescent Current VS Input Voltage

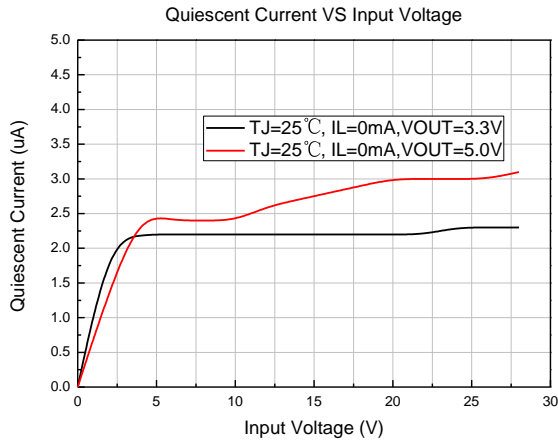

2. Reverse Output Current VS Output Voltage

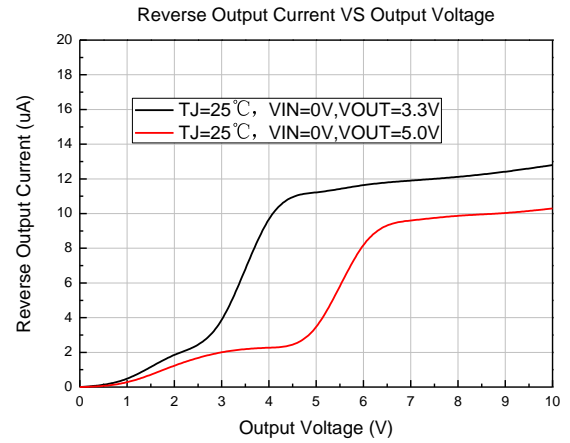

3. Current Limit VS Vin-Vout

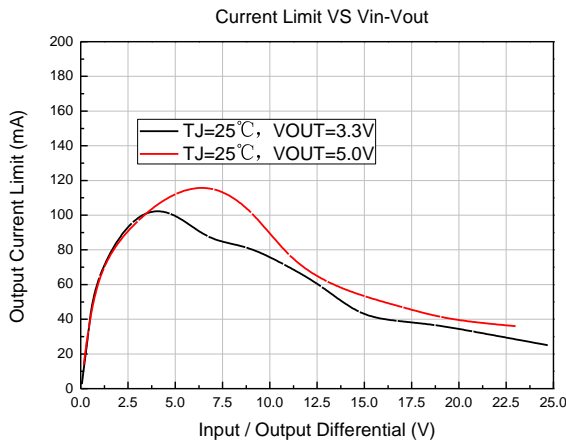

4. GND Pin Current VS Output Current

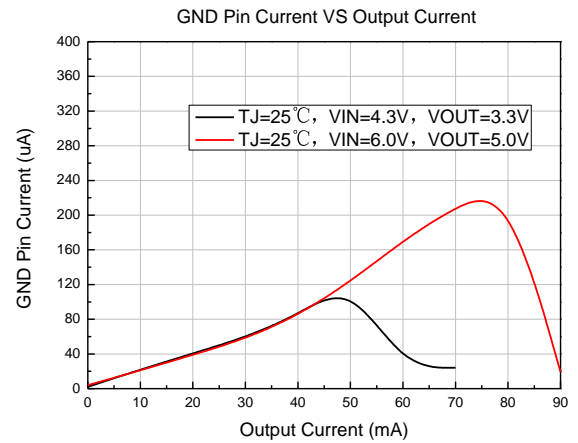

5. GND Pin Current VS Input Voltage

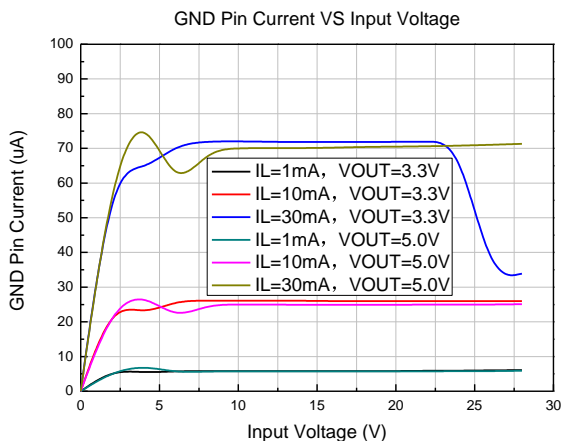

6. Dropout Voltage VS Temperature

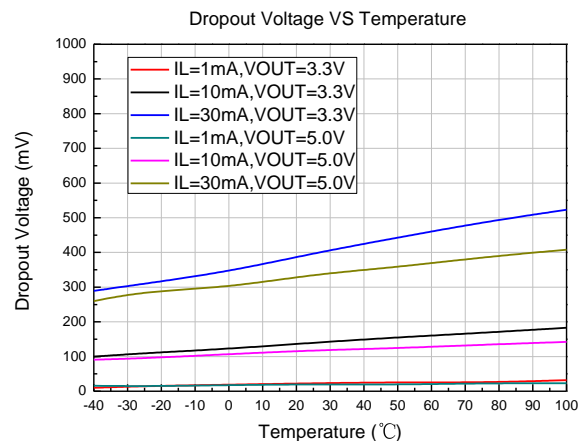

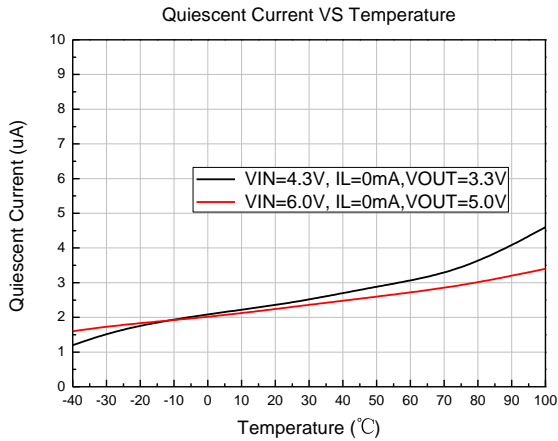
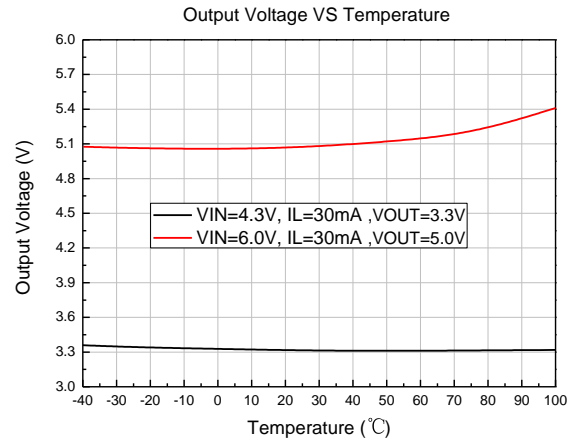
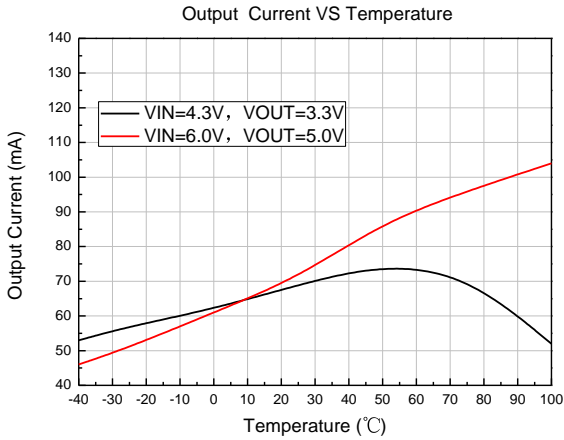
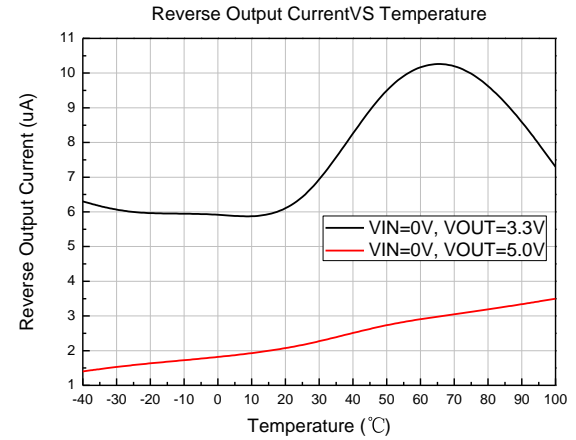
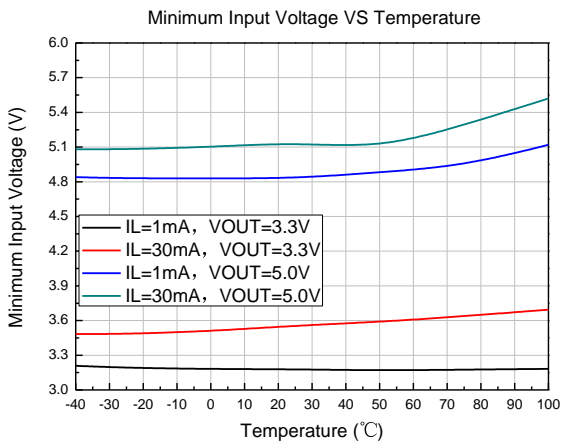
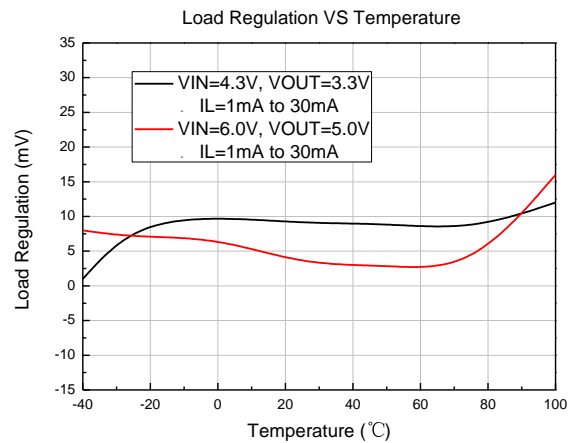
7. Quiescent Current VS Temperature

8. Output Voltage VS Temperature

9. Output Current VS Temperature

10. Reverse Output Current VS Temperature

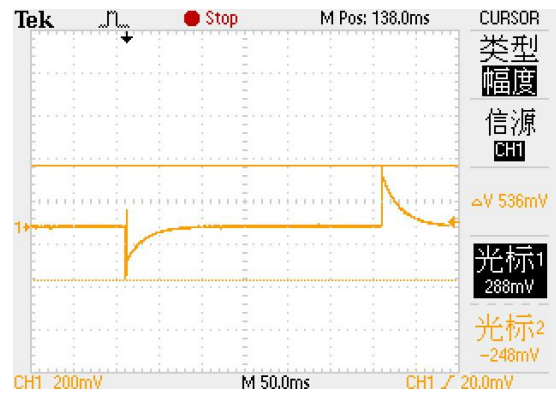
11. Minimum Input Voltage VS Temperature

12. Load Regulation VS Temperature

13. Input voltage transient response (IL=10mA)



14. Load transient response (VIN=4.3V, IL=0-70-0mA)



Package Information

● SOT-89-3L

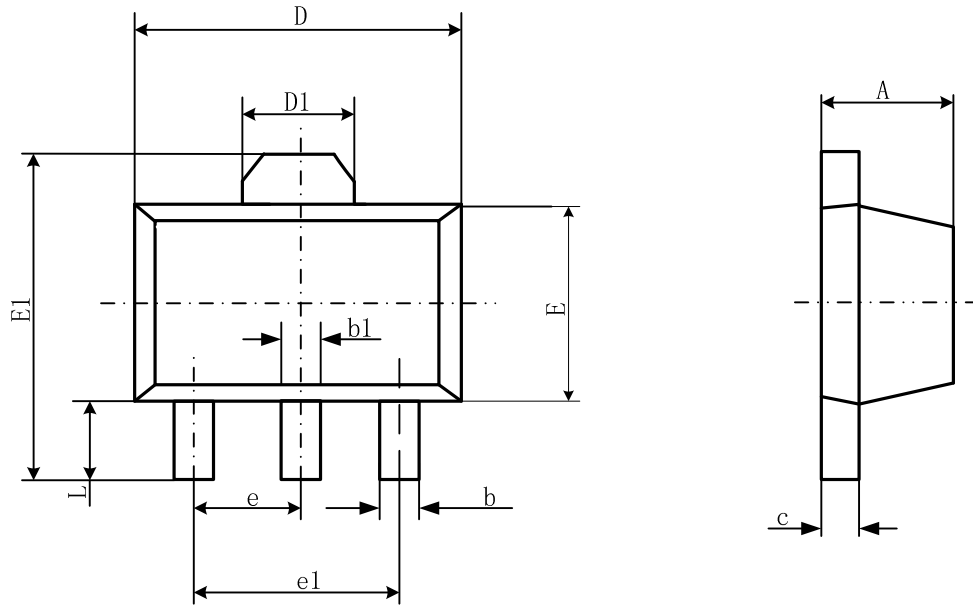

Symbol	Dimensions In Millimeters		Dimensions In Inches	
	Min	Max	Min	Max
A	1.400	1.600	0.055	0.063
b	0.320	0.520	0.013	0.020
b1	0.400	0.580	0.016	0.023
c	0.350	0.400	0.014	0.017
D	4.400	4.600	0.173	0.181
D1	1.550REF.		0.061REF.	
E	2.300	2.600	0.091	0.102
E1	3.940	4.250	0.155	0.167
e	1.500TYP		0.060TYP	
e1	3.000TYP		0.118TYP	
L	0.900	1.200	0.035	0.047

● TO-92

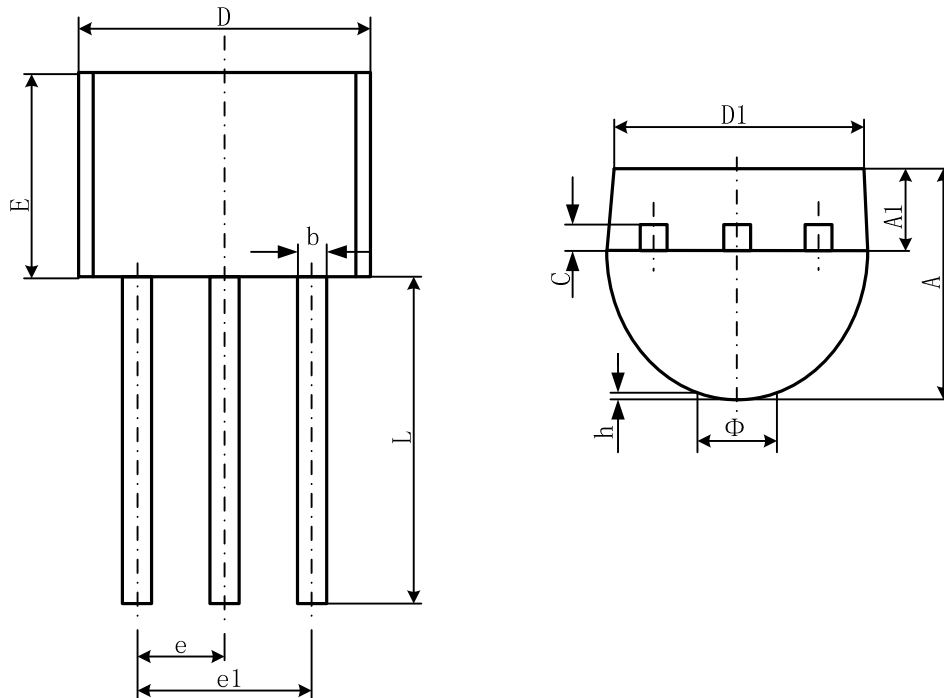

Symbol	Dimensions In Millimeters		Dimensions In Inches	
	Min	Max	Min	Max
A	3.300	3.700	0.130	0.146
A1	1.100	1.400	0.043	0.055
b	0.380	0.550	0.015	0.022
c	0.360	0.510	0.014	0.020
D	4.400	4.700	0.173	0.185
D1	3.430		0.135	
E	4.300	4.700	0.169	0.185
e	1.270TYP		0.050TYP	
e1	2.440	2.640	0.096	0.104
L	14.100	14.500	0.555	0.571
Φ		1.600		0.063
h	0.000	0.380	0.000	0.015

- SOT-23-3L

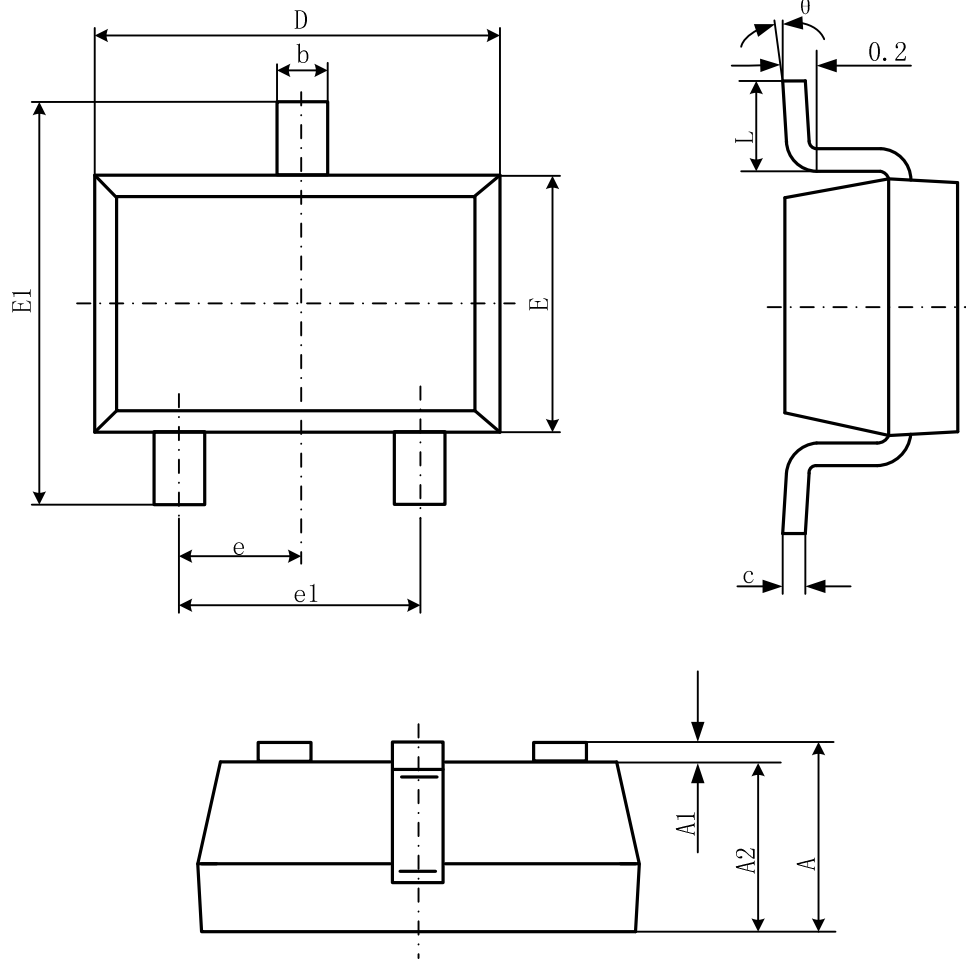

Symbol	Dimensions In Millimeters		Dimensions In Inches	
	Min	Max	Min	Max
A	1.050	1.250	0.041	0.049
A1	0.000	0.100	0.000	0.004
A2	1.050	1.150	0.041	0.045
b	0.300	0.500	0.012	0.020
c	0.100	0.200	0.004	0.008
D	2.820	3.020	0.111	0.119
E	1.500	1.700	0.059	0.067
E1	2.650	2.950	0.104	0.116
e	0.950(BSC)		0.037(BSC)	
e1	1.800	2.000	0.071	0.079
L	0.300	0.600	0.012	0.024
θ	0°	8°	0°	8°

● SOT-23-5L

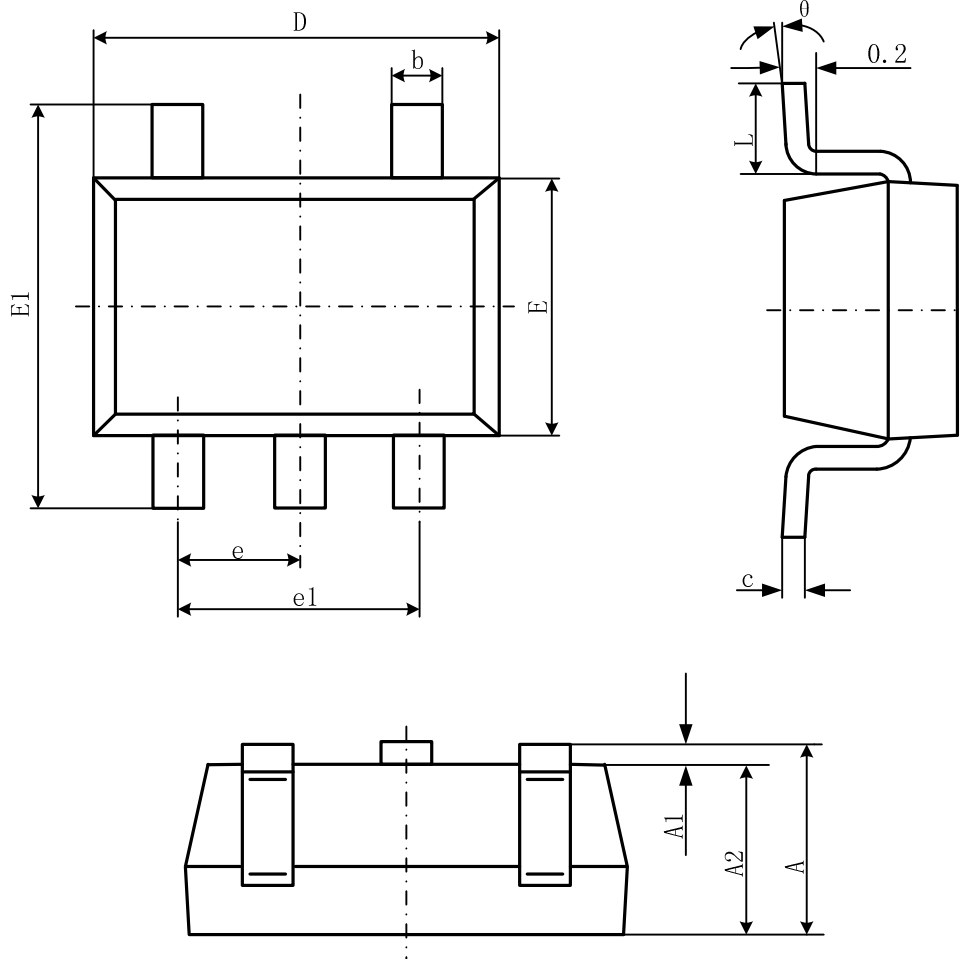

Symbol	Dimensions In Millimeters		Dimensions In Inches	
	Min	Max	Min	Max
A	1.050	1.250	0.041	0.049
A1	0.000	0.100	0.000	0.004
A2	1.050	1.150	0.041	0.045
b	0.300	0.500	0.012	0.020
c	0.100	0.200	0.004	0.008
D	2.820	3.020	0.111	0.119
E	1.500	1.700	0.059	0.067
E1	2.650	2.950	0.104	0.116
e	0.950(BSC)		0.037(BSC)	
e1	1.800	2.000	0.071	0.079
L	0.300	0.600	0.012	0.024
θ	0°	8°	0°	8°