

3 mm (T1) LED, Non Diffused

LS 3340, LO 3340, LY 3340  
LG 3330, LP 3340

## Besondere Merkmale

- eingefärbtes, klares Gehäuse
- zur Einkopplung in Lichtleiter
- als optischer Indikator einsetzbar
- Lötspieße mit Aufsetzebene
- gegurtet lieferbar
- Störimpulsfest nach DIN 40839

## Features

- colored, clear package
- optical coupling into light pipes
- for use as optical indicator
- solder leads with stand-off
- available taped on reel
- load dump resistant acc. to DIN 40839

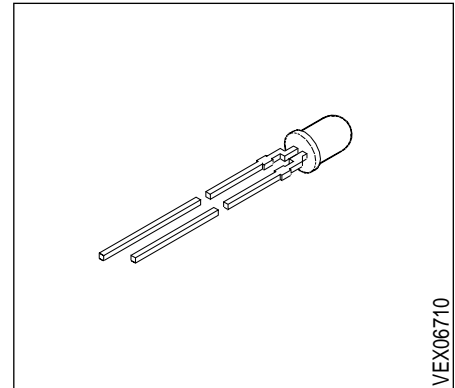

Typ Type	Emissionsfarbe Color of Emission	Gehäusefarbe Color of Package	Lichtstärke Luminous Intensity $I_F = 10 \text{ mA}$ $I_V \text{ (mcd)}$	Bestellnummer Ordering Code
LS 3340-KN LS 3340-L LS 3340-M LS 3340-N LS 3340-LP	super-red	red clear	6.3 ... 50.0 10.0 ... 20.0 16.0 ... 32.0 25.0 ... 50.0 10.0 ... 80.0	Q62703-Q1701 Q62703-Q1702 Q62703-Q1704 Q62703-Q2320 Q62703-Q3223
LO 3340-KN LO 3340-L LO 3340-M LO 3340-N LO 3340-LP	orange	orange clear	6.3 ... 50.0 10.0 ... 20.0 16.0 ... 32.0 25.0 ... 50.0 10.0 ... 80.0	Q62703-Q1886 Q62703-Q2256 Q62703-Q2255 Q62703-Q2473 Q62703-Q2628
LY 3340-JM LY 3340-L LY 3340-M LY 3340-N LY 3340-LP	yellow	yellow clear	4.0 ... 32.0 10.0 ... 20.0 16.0 ... 32.0 25.0 ... 50.0 10.0 ... 80.0	Q62703-Q1789 Q62703-Q1791 Q62703-Q1999 Q62703-Q2652 Q62703-Q1792
LG 3330-KN LG 3330-L LG 3330-M LG 3330-N LG 3330-LP	green	colorless clear	6.3 ... 50.0 10.0 ... 20.0 16.0 ... 32.0 25.0 ... 50.0 10.0 ... 80.0	Q62703-Q1698 Q62703-Q1699 Q62703-Q1700 Q62703-Q2010 Q62703-Q2011
LP 3340-JL LP 3340-K LP 3340-L LP 3340-KM	pure green	green clear	4.0 ... 20.0 6.3 ... 12.5 10.0 ... 20.0 6.3 ... 32.0	Q62703-Q2749 Q62703-Q2982 Q62703-Q2980 Q62703-Q3211

Streuung der Lichtstärke in einer Verpackungseinheit  $I_{V \max} / I_{V \min} \leq 2.0$ .  
Luminous intensity ratio in one packaging unit  $I_{V \max} / I_{V \min} \leq 2.0$ .

**Grenzwerte**  
**Maximum Ratings**

Bezeichnung Parameter	Symbol Symbol	Werte Values		Einheit Unit
		LS, LO, LY, LG	LP	
Betriebstemperatur Operating temperature range	$T_{op}$	- 55 ... + 100		°C
Lagertemperatur Storage temperature range	$T_{stg}$	- 55 ... + 100		°C
Sperrschichttemperatur Junction temperature	$T_j$	+ 100		°C
Durchlaßstrom Forward current	$I_F$	40	30	mA
Stoßstrom Surge current $t \leq 10 \mu s, D = 0.005$	$I_{FM}$	0.5		A
Sperrspannung Reverse voltage	$V_R$	5		V
Verlustleistung Power dissipation $T_A \leq 25 \text{ °C}$	$P_{tot}$	140	100	mW
Wärmewiderstand Thermal resistance Sperrschicht / Luft Junction / air	$R_{th JA}$	400		K/W

### Kennwerte ( $T_A = 25\text{ °C}$ )

### Characteristics

Bezeichnung Parameter	Symbol Symbol	Werte Values					Einheit Unit
		LS	LO	LY	LG	LP	
Wellenlänge des emittierten Lichtes Wavelength at peak emission $I_F = 20\text{ mA}$	(typ.) $\lambda_{\text{peak}}$ (typ.)	635	610	586	565	557	nm
Dominantwellenlänge Dominant wavelength $I_F = 20\text{ mA}$	(typ.) $\lambda_{\text{dom}}$ (typ.)	628	605	590	570	560	nm
Spektrale Bandbreite bei 50 % $I_{\text{rel max}}$ Spectral bandwidth at 50 % $I_{\text{rel max}}$ $I_F = 20\text{ mA}$	(typ.) $\Delta\lambda$ (typ.)	45	40	45	25	22	nm
Abstrahlwinkel bei 50 % $I_V$ (Vollwinkel) Viewing angle at 50 % $I_V$	$2\phi$	50	50	50	50	50	Grad deg.
Durchlaßspannung Forward voltage $I_F = 10\text{ mA}$	(typ.) $V_F$ (max.) $V_F$	2.0 2.6	2.0 2.6	2.0 2.6	2.0 2.6	2.0 2.6	V V
Sperrstrom Reverse current $V_R = 5\text{ V}$	(typ.) $I_R$ (max.) $I_R$	0.01 10	0.01 10	0.01 10	0.01 10	0.01 10	$\mu\text{A}$ $\mu\text{A}$
Kapazität Capacitance $V_R = 0\text{ V}, f = 1\text{ MHz}$	(typ.) $C_0$	12	8	10	15	15	pF
Schaltzeiten: Switching times: $I_V$ from 10 % to 90 % $I_V$ from 90 % to 10 % $I_F = 100\text{ mA}, t_p = 10\text{ }\mu\text{s}, R_L = 50\text{ }\Omega$	(typ.) $t_r$ (typ.) $t_f$	300 150	300 150	300 150	450 200	450 200	ns ns

Relative spektrale Emission  $I_{rel} = f(\lambda)$ ,  $T_A = 25\text{ °C}$ ,  $I_F = 20\text{ mA}$

### Relative spectral emission

$V(\lambda)$  = spektrale Augenempfindlichkeit

Standard eye response curve

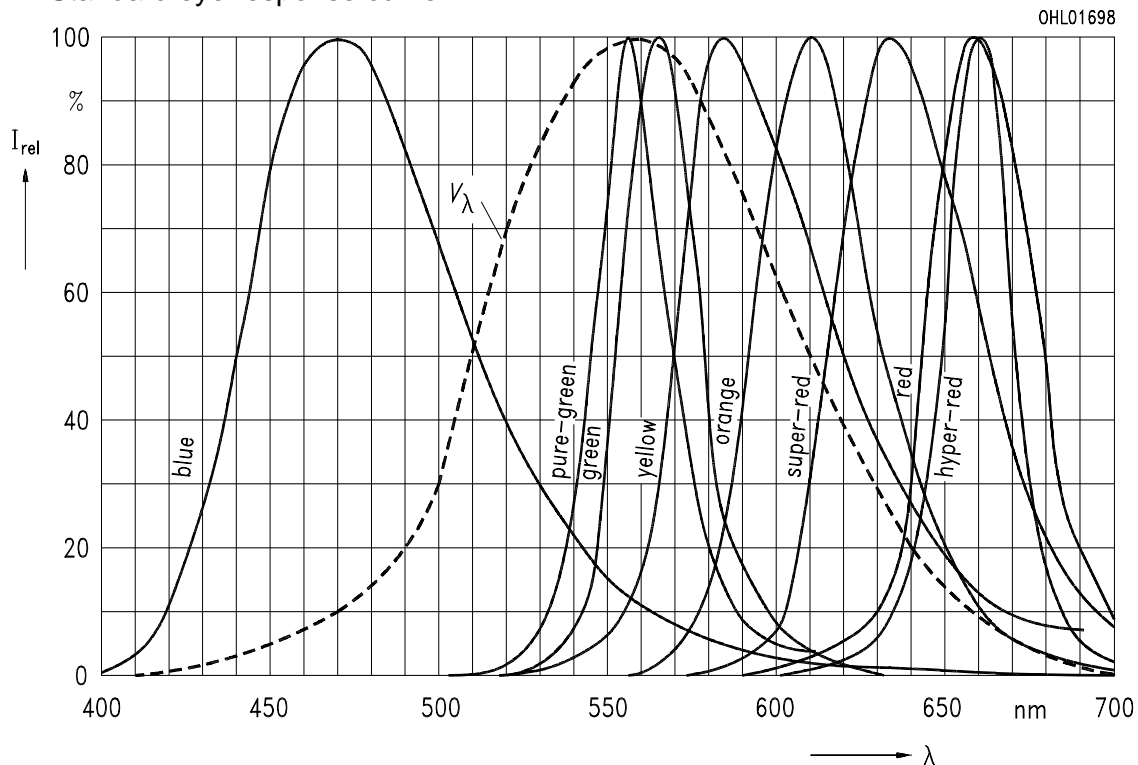

Abstrahlcharakteristik  $I_{rel} = f(\varphi)$

### Radiation characteristic

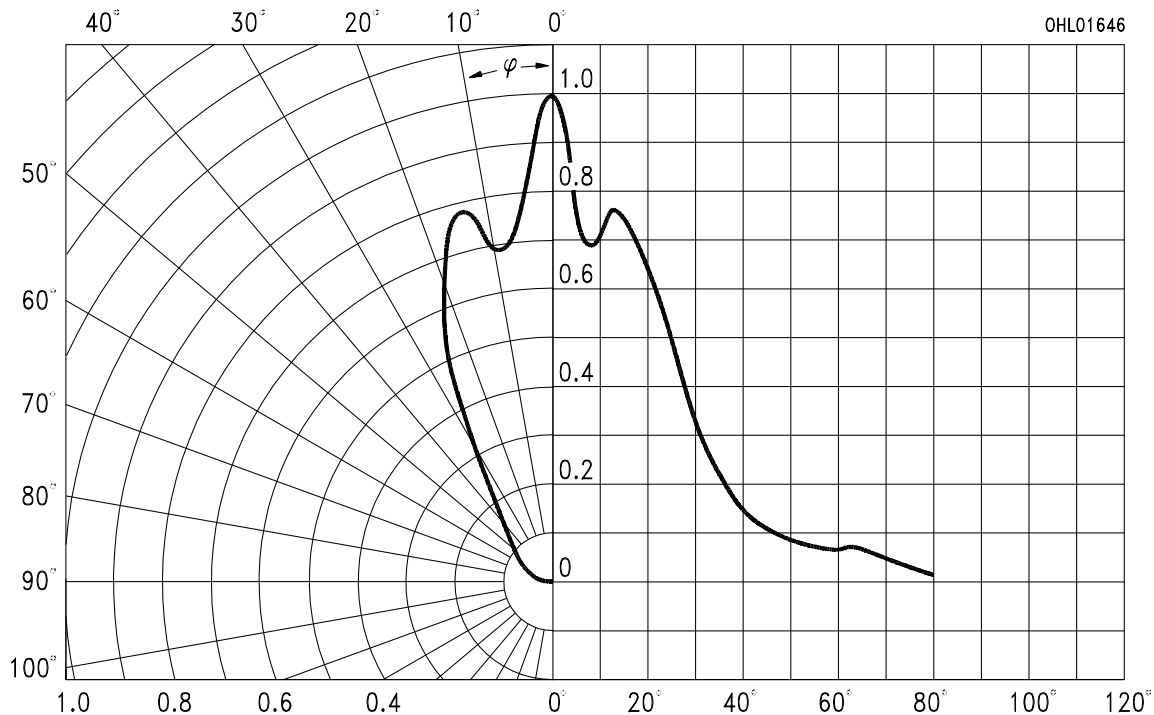

### Durchlaßstrom $I_F = f(V_F)$

#### Forward current

$T_A = 25^\circ\text{C}$

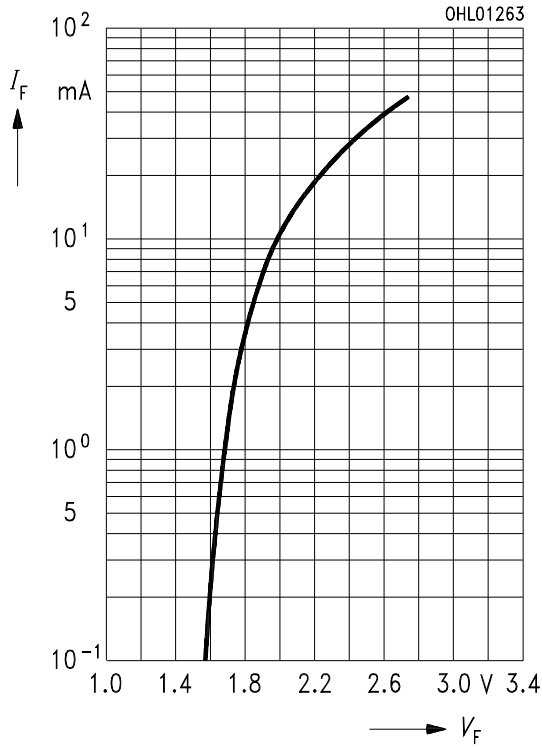

### Relative Lichtstärke $I_V/I_{V(10\text{mA})} = f(I_F)$

#### Relative luminous intensity

$T_A = 25^\circ\text{C}$

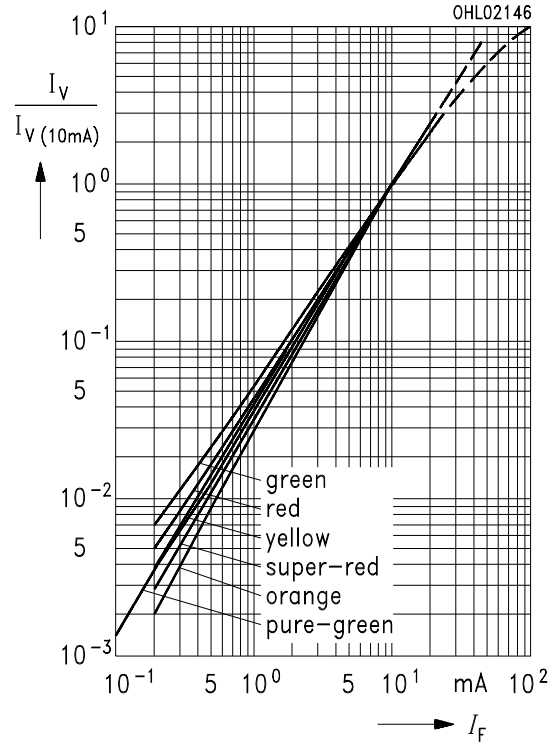

### Zulässige Impulsbelastbarkeit $I_F = f(t_p)$

#### Permissible pulse handling capability

Duty cycle  $D = \text{parameter}$ ,  $T_A = 25^\circ\text{C}$

LS, LO, LY, LG

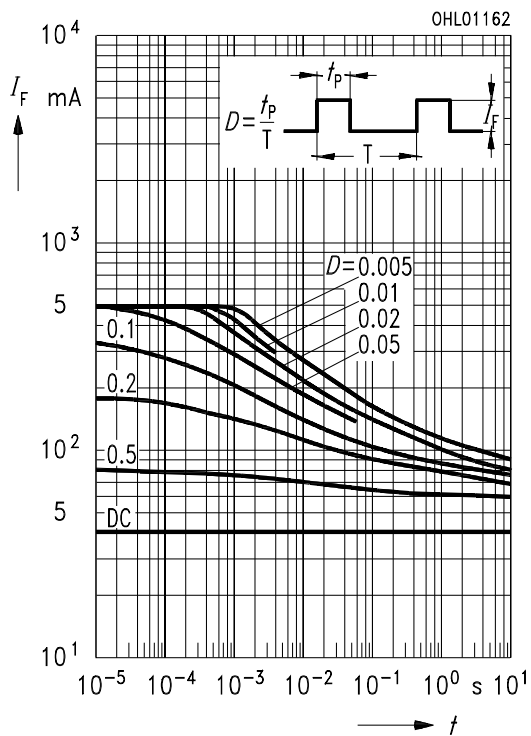

### Zulässige Impulsbelastbarkeit $I_F = f(t_p)$

#### Permissible pulse handling capability

Duty cycle  $D = \text{parameter}$ ,  $T_A = 25^\circ\text{C}$

LP

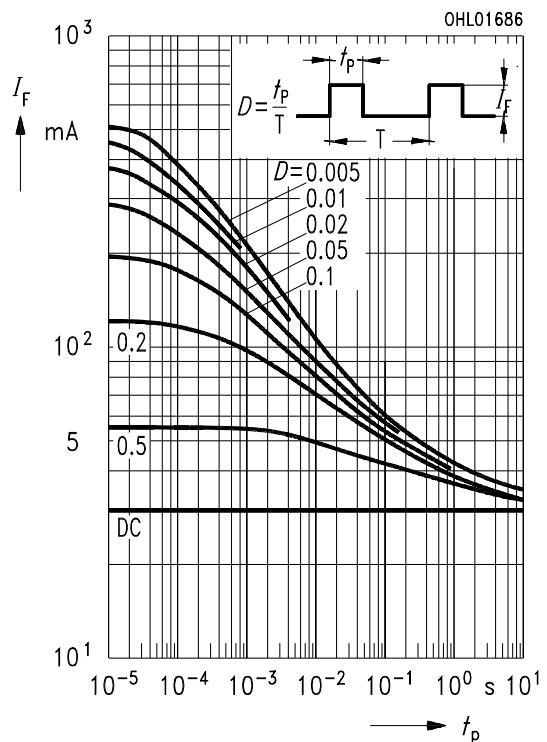

**Maximal zulässiger Durchlaßstrom**  
**Max. permissible forward current**

$I_F = f(T_A)$

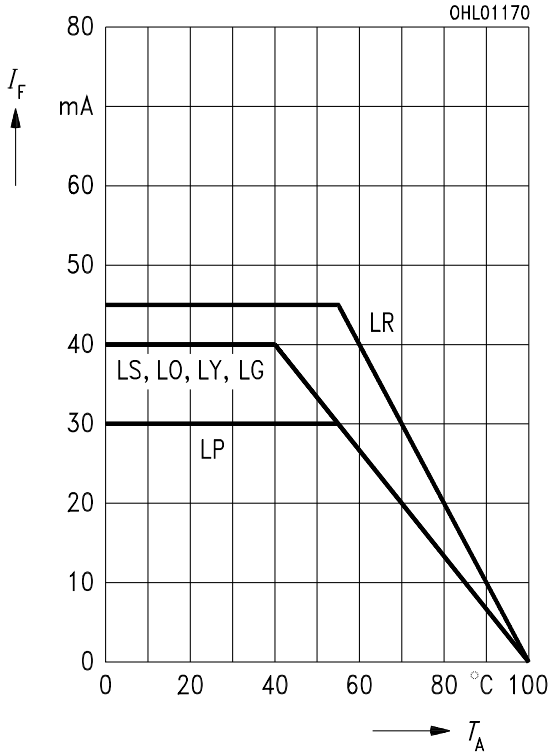

**Wellenlänge der Strahlung  $\lambda_{peak} = f(T_A)$**   
**Wavelength at peak emission**

$I_F = 20 \text{ mA}$

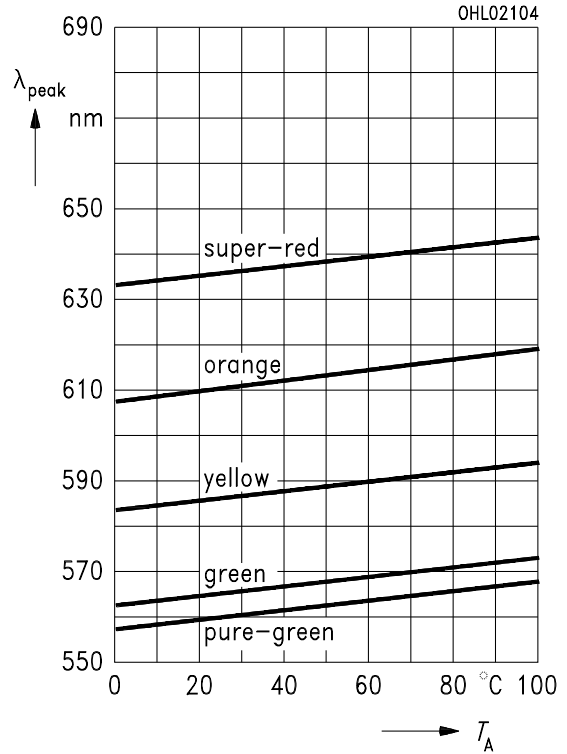

**Dominantwellenlänge  $\lambda_{dom} = f(T_A)$**   
**Dominant wavelength**

$I_F = 20 \text{ mA}$

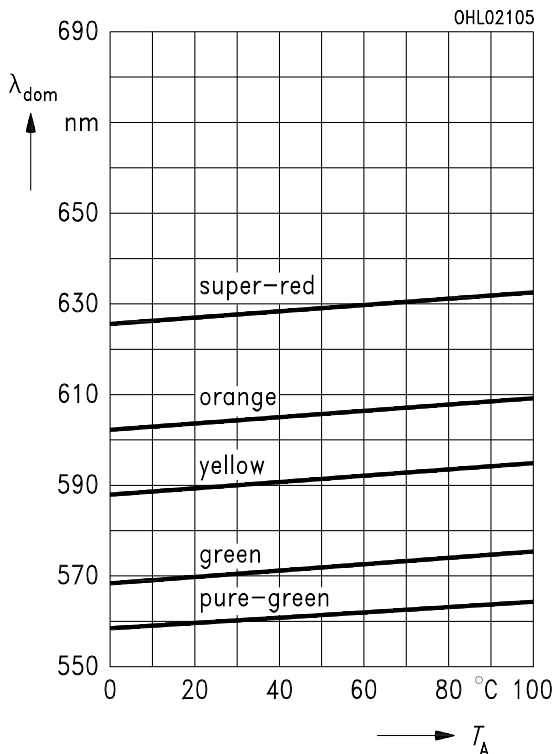

**Durchlaßspannung  $V_F = f(T_A)$**   
**Forward voltage**

$I_F = 10 \text{ mA}$

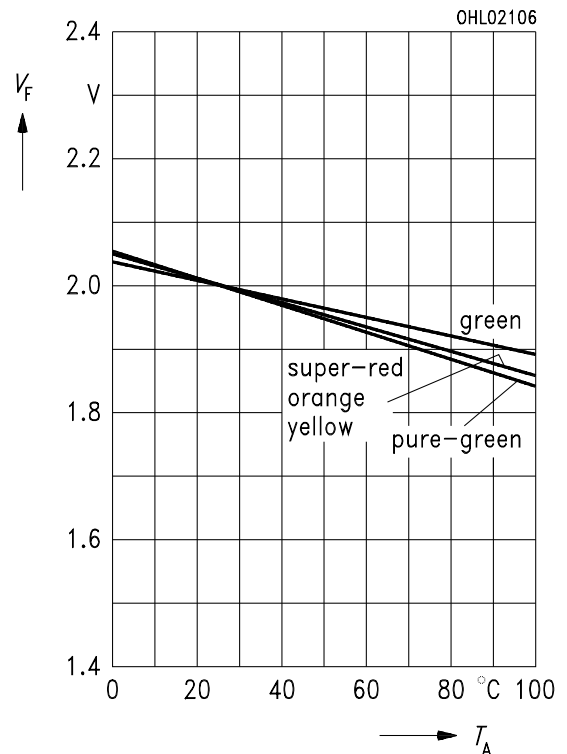

Relative Lichtstärke  $I_V/I_{V(25^\circ\text{C})} = f(T_A)$

Relative luminous intensity

$I_F = 10 \text{ mA}$

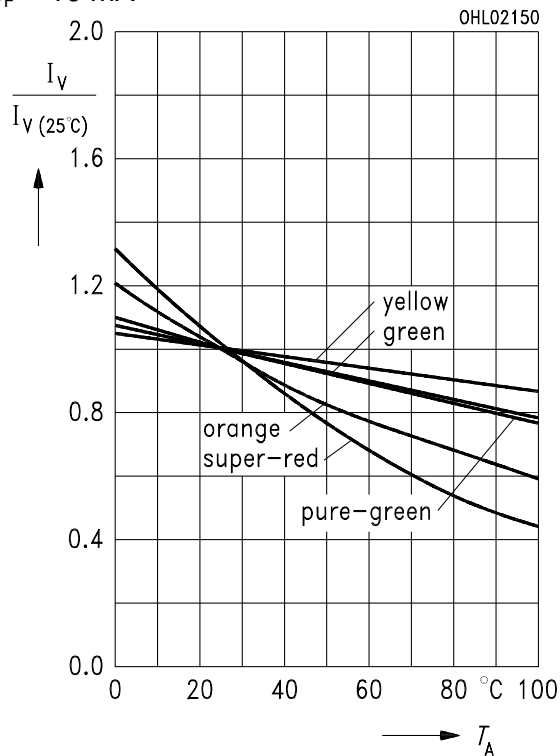

**Maßzeichnung** (Maße in mm, wenn nicht anders angegeben)  
**Package Outlines** (Dimensions in mm, unless otherwise specified)

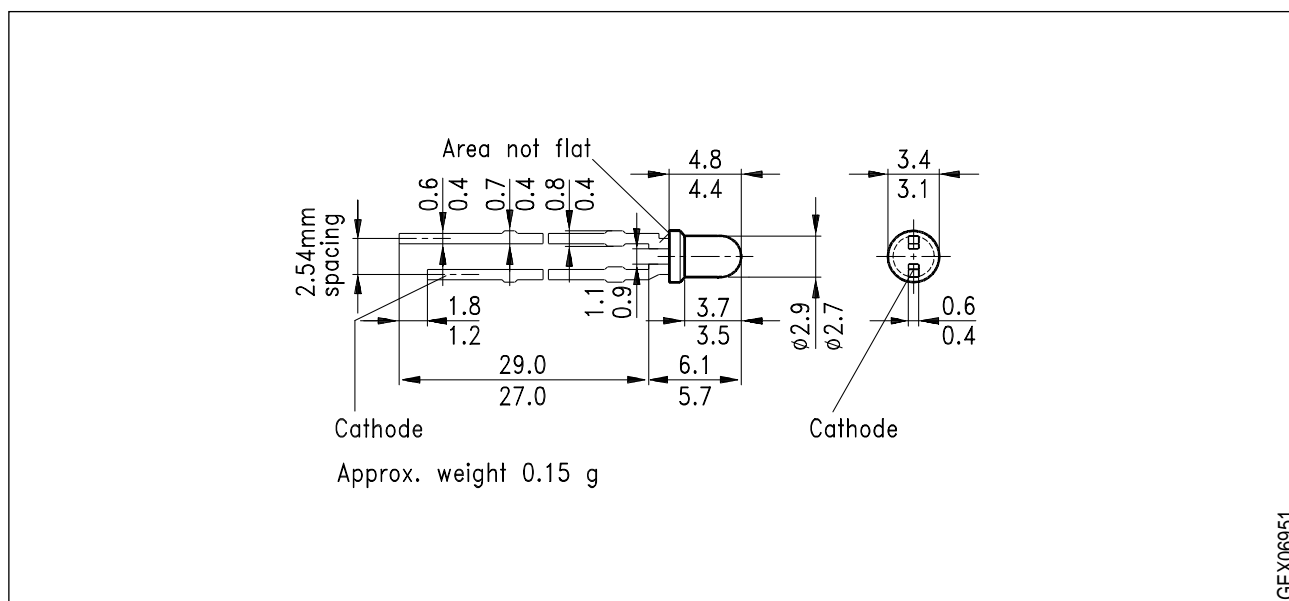

**Kathodenkennzeichnung:** Kürzerer Lötspieß  
**Cathode mark:** Short solder lead