

## Mini TOPLED®

LS M670, LO M670, LY M670  
LG M670, LP M670

### Besondere Merkmale

- Gehäusefarbe: weiß
- als optischer Indikator einsetzbar
- zur Hinterleuchtung, Lichtleiter- und Linseneinkopplung
- für alle SMT-Bestück- und Löttechniken geeignet
- gegurtet (8-mm-Filmgurt)
- Störimpulsfest nach DIN 40839

### Features

- color of package: white
- for use as optical indicator
- for backlighting, optical coupling into light pipes and lenses
- suitable for all SMT assembly and soldering methods
- available taped on reel (8 mm tape)
- load dump resistant acc. to DIN 40839

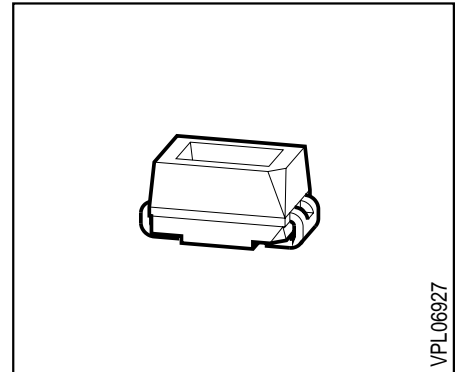

Typ	Emissions- farbe	Farbe der Lichtaustritts- fläche	Lichtstärke	Lichtstrom	Bestellnummer
Type	Color of Emission	Color of the Light Emitting Area	Luminous Intensity $I_F = 10 \text{ mA}$ $I_V \text{ (mcd)}$	Luminous Flux $I_F = 10 \text{ mA}$ $\Phi_V \text{ (mlm)}$	Ordering Code
LS M670-HK	super-red	colorless clear	2.5 ... 12.5	-	Q62703-Q3380
LS M670-J			4.0 ... 8.0	18 (typ.)	Q62703-Q3381
LS M670-K			6.3 ... 12.5	30 (typ.)	Q62703-Q3382
LS M670-JM			4.0 ... 32.0	-	Q62703-Q3383
LO M670-HK	orange	colorless clear	2.5 ... 12.5	-	Q62703-Q3384
LO M670-J			4.0 ... 8.0	18 (typ.)	Q62703-Q3385
LO M670-K			6.3 ... 12.5	30 (typ.)	Q62703-Q3386
LO M670-JM			4.0 ... 32.0	-	Q62703-Q3387
LY M670-HK	yellow	colorless clear	2.5 ... 12.5	-	Q62703-Q3388
LY M670-J			4.0 ... 8.0	18 (typ.)	Q62703-Q3389
LY M670-K			6.3 ... 12.5	30 (typ.)	Q62703-Q3390
LY M670-JM			4.0 ... 32.0	-	Q62703-Q3391
LG M670-HK	green	colorless clear	2.5 ... 12.5	-	Q62703-Q3392
LG M670-J			4.0 ... 8.0	18 (typ.)	Q62703-Q3393
LG M670-K			6.3 ... 12.5	30 (typ.)	Q62703-Q3394
LG M670-JM			4.0 ... 32.0	-	Q62703-Q3395
LP M670-FJ	pure green	colorless clear	1.0 ... 8.0	-	Q62703-Q3396
LP M670-G			1.6 ... 3.2	8 (typ.)	Q62703-Q3397
LP M670-H			2.5 ... 5.0	12 (typ.)	Q62703-Q3398
LP M670-GK			1.6 ... 12.5	-	Q62703-Q3399

Streuung der Lichtstärke in einer Verpackungseinheit  $I_{V \max} / I_{V \min} \leq 2.0$ .

Luminous intensity ratio in one packaging unit  $I_{V \max} / I_{V \min} \leq 2.0$ .

### Grenzwerte Maximum Ratings

Bezeichnung Parameter	Symbol Symbol	Werte Values	Einheit Unit
Betriebstemperatur Operating temperature range	$T_{op}$	- 55 ... + 100	°C
Lagertemperatur Storage temperature range	$T_{stg}$	- 55 ... + 100	°C
Sperrschichttemperatur Junction temperature	$T_j$	+ 100	°C
Durchlaßstrom Forward current	$I_F$	30	mA
Stoßstrom Surge current $t \leq 10 \mu s, D = 0.005$	$I_{FM}$	0.5	A
Sperrspannung Reverse voltage	$V_R$	5	V
Verlustleistung Power dissipation	$P_{tot}$	80	mW
Wärmewiderstand Thermal resistance Sperrschicht / Umgebung Junction / air Montage auf PC-board*) (Padgröße $\geq 16 \text{ mm}^2$ ) mounted on PC board*) (pad size $\geq 16 \text{ mm}^2$ )	$R_{th JA}$	480 <sup>1)</sup>	K/W

\*) PC-board: FR4

1) vorläufig/preliminary

**Kennwerte** ( $T_A = 25\text{ °C}$ )

**Characteristics**

Bezeichnung Parameter	Symbol Symbol	Werte Values					Einheit Unit
		LS	LO	LY	LG	LP	
Wellenlänge des emittierten Lichtes (typ.) Wavelength at peak emission (typ.) $I_F = 10\text{ mA}$	$\lambda_{\text{peak}}$	635	610	586	565	557	nm
Dominantwellenlänge (typ.) Dominant wavelength (typ.) $I_F = 10\text{ mA}$	$\lambda_{\text{dom}}$	628	605	590	570	560	nm
Spektrale Bandbreite bei 50 % $I_{\text{rel max}}$ (typ.) Spectral bandwidth at 50 % $I_{\text{rel max}}$ (typ.) $I_F = 10\text{ mA}$	$\Delta\lambda$	45	40	45	25	22	nm
Abstrahlwinkel bei 50 % $I_v$ (Vollwinkel) Viewing angle at 50 % $I_v$	$2\phi$	120	120	120	120	120	Grad deg.
Durchlaßspannung (typ.) Forward voltage (max.) $I_F = 10\text{ mA}$	$V_F$ $V_F$	2.0 2.6	2.0 2.6	2.0 2.6	2.0 2.6	2.0 2.6	V V
Sperrstrom (typ.) Reverse current (max.) $V_R = 5\text{ V}$	$I_R$ $I_R$	0.01 10	0.01 10	0.01 10	0.01 10	0.01 10	$\mu\text{A}$ $\mu\text{A}$
Kapazität (typ.) Capacitance $V_R = 0\text{ V}, f = 1\text{ MHz}$	$C_0$	12	8	10	15	15	pF
Schaltzeiten: Switching times: $I_V$ from 10 % to 90 % (typ.) $I_V$ from 90 % to 10 % (typ.) $I_F = 100\text{ mA}, t_p = 10\text{ }\mu\text{s}, R_L = 50\text{ }\Omega$	$t_r$ $t_f$	300 150	300 150	300 150	450 200	450 200	ns ns

Relative spektrale Emission  $I_{rel} = f(\lambda)$ ,  $T_A = 25^\circ\text{C}$ ,  $I_F = 10\text{ mA}$

**Relative spectral emission**

$V(\lambda)$  = spektrale Augenempfindlichkeit

Standard eye response curve

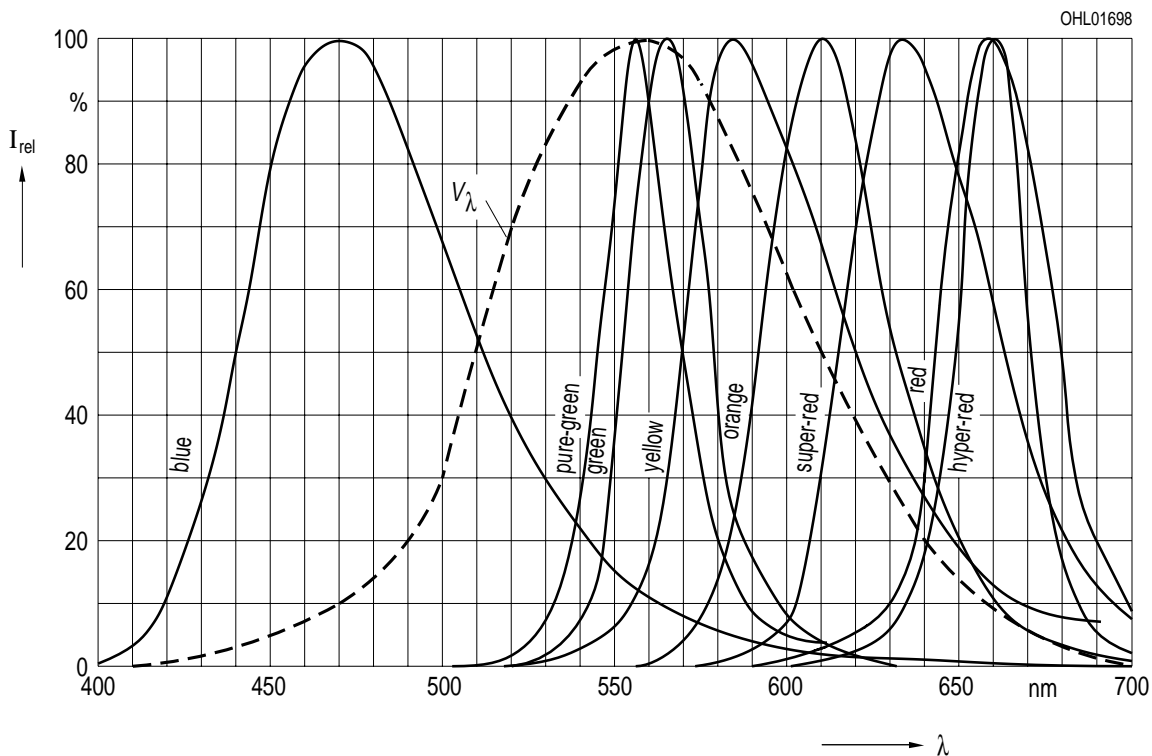

Abstrahlcharakteristik  $I_{rel} = f(\varphi)$

**Radiation characteristic**

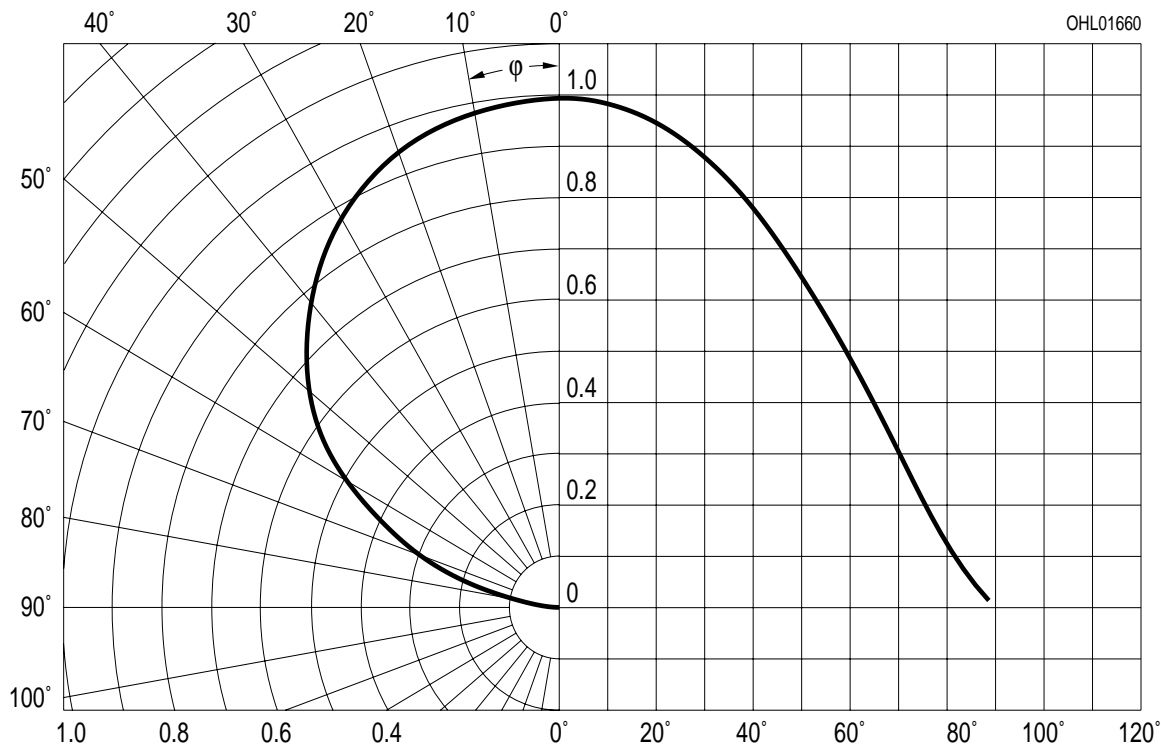

### Durchlaßstrom $I_F = f(V_F)$

Forward current

$T_A = 25\text{ °C}$

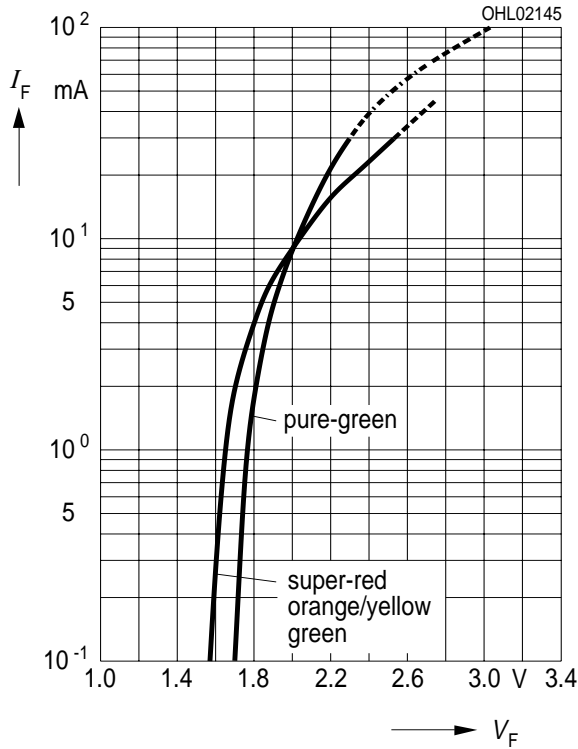

### Relative Lichtstärke $I_V/I_{V(10\text{ mA})} = f(I_F)$

Relative luminous intensity

$T_A = 25\text{ °C}$

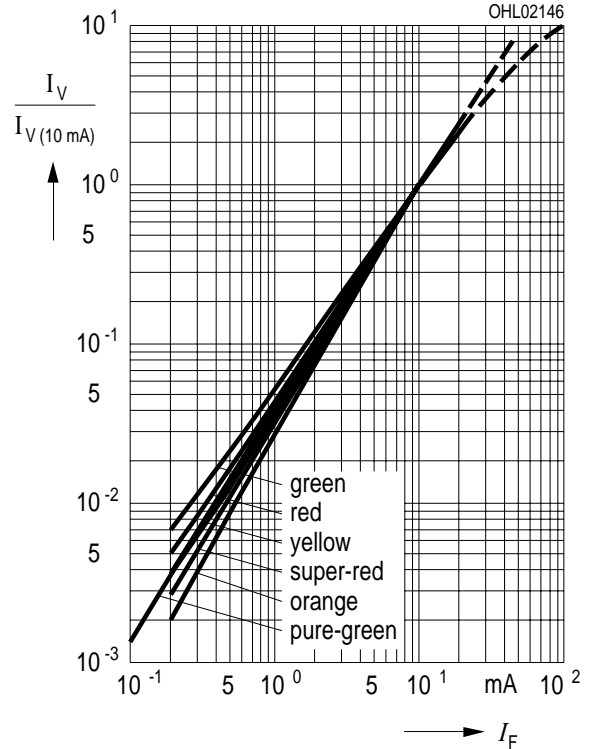

### Zulässige Impulsbelastbarkeit $I_F = f(t_p)$

Permissible pulse handling capability

Duty cycle  $D =$  parameter,  $T_A = 25\text{ °C}$

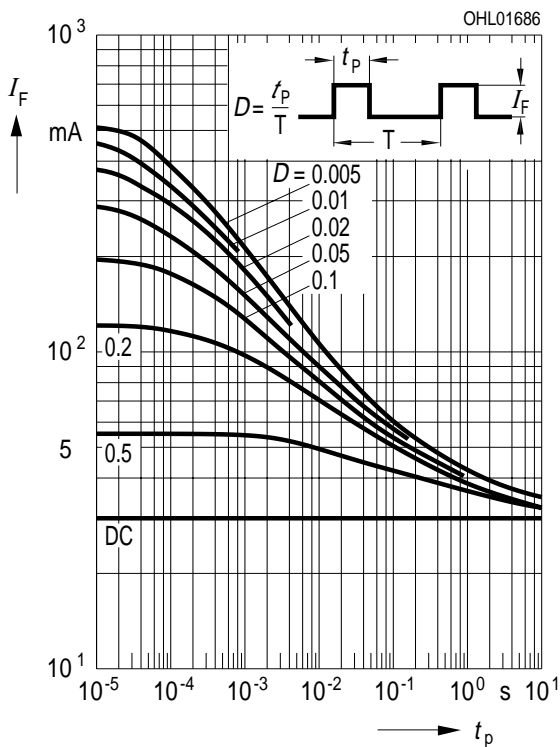

### Maximal zulässiger Durchlaßstrom

Max. permissible forward current

$I_F = f(T_A)$

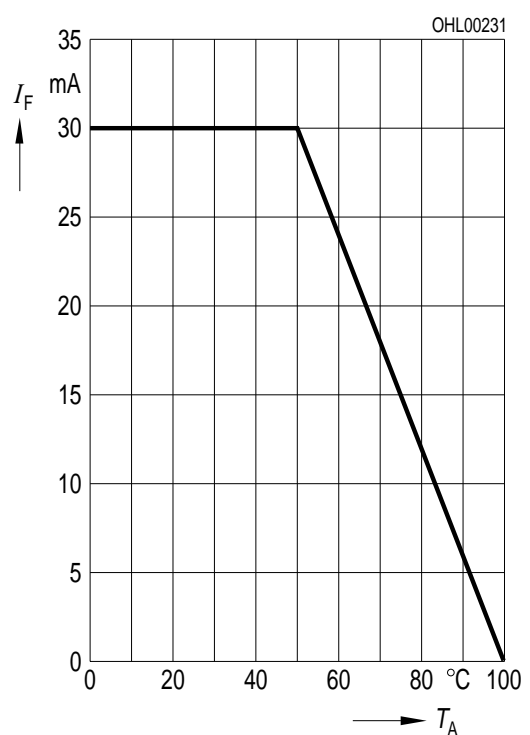

**Wellenlänge der Strahlung  $\lambda_{\text{peak}} = f(T_A)$**   
**Wavelength at peak emission**

$I_F = 10 \text{ mA}$

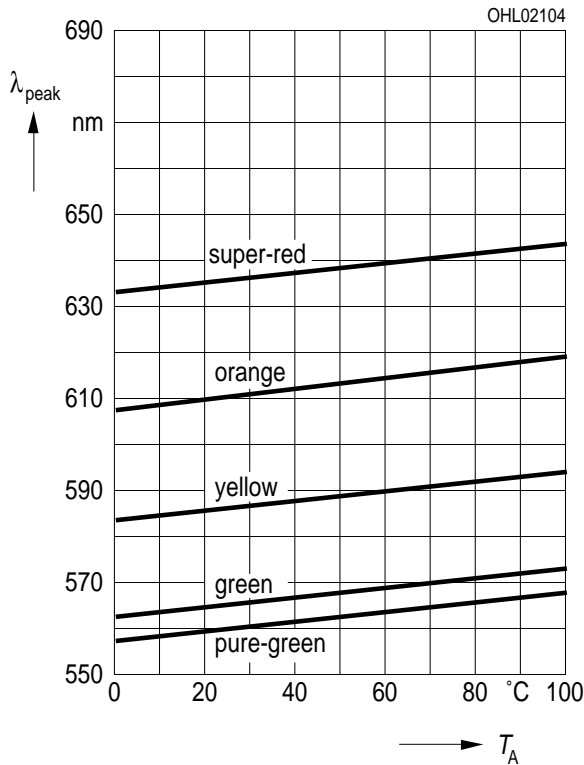

**Dominantwellenlänge  $\lambda_{\text{dom}} = f(T_A)$**   
**Dominant wavelength**

$I_F = 10 \text{ mA}$

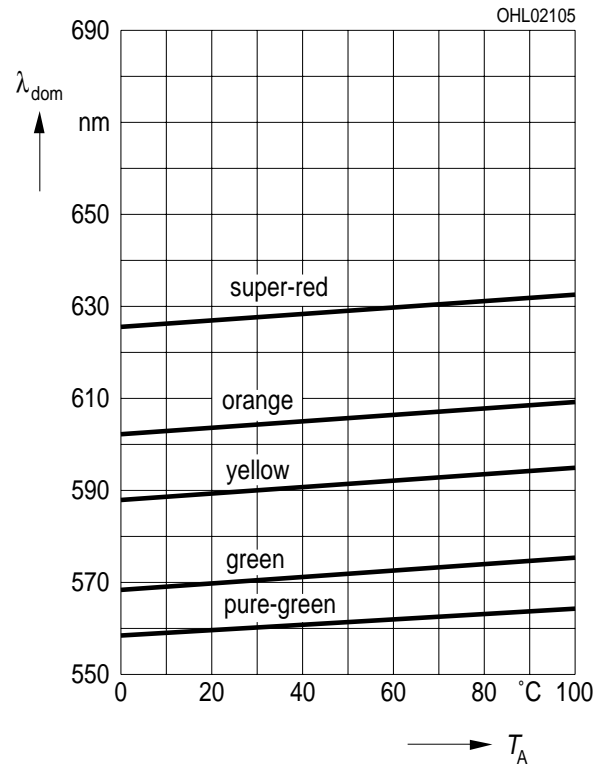

**Durchlaßspannung  $V_F = f(T_A)$**   
**Forward voltage**

$I_F = 10 \text{ mA}$

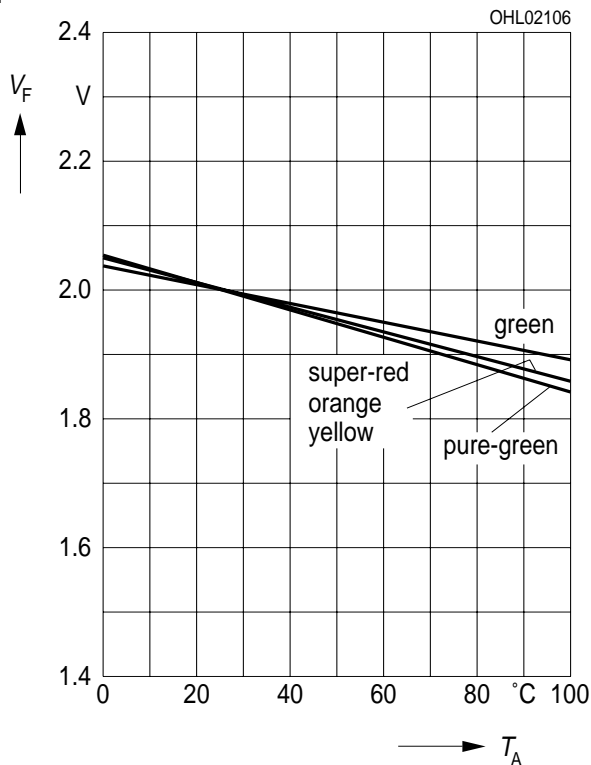

**Relative Lichtstärke  $I_V / I_{V(25^\circ\text{C})} = f(T_A)$**   
**Relative luminous intensity**

$I_F = 10 \text{ mA}$

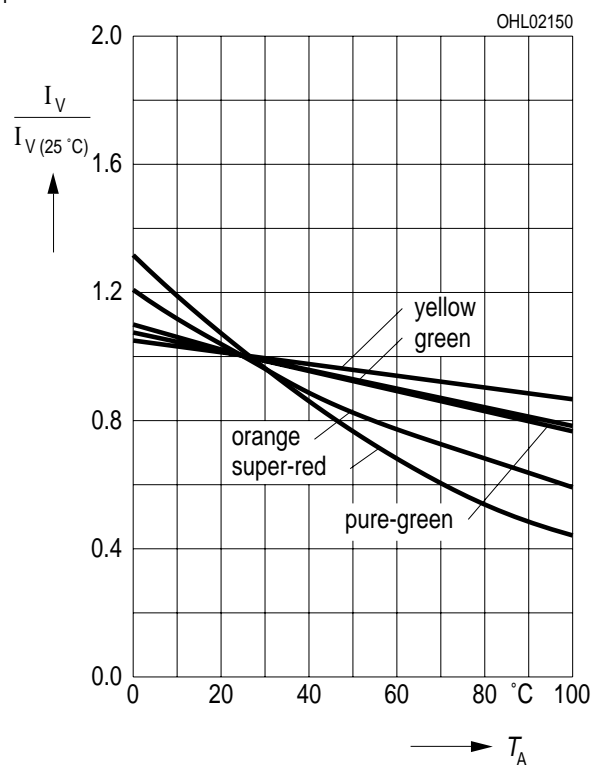

**Maßzeichnung** (Maße in mm, wenn nicht anders angegeben)  
**Package Outlines** (Dimensions in mm, unless otherwise specified)

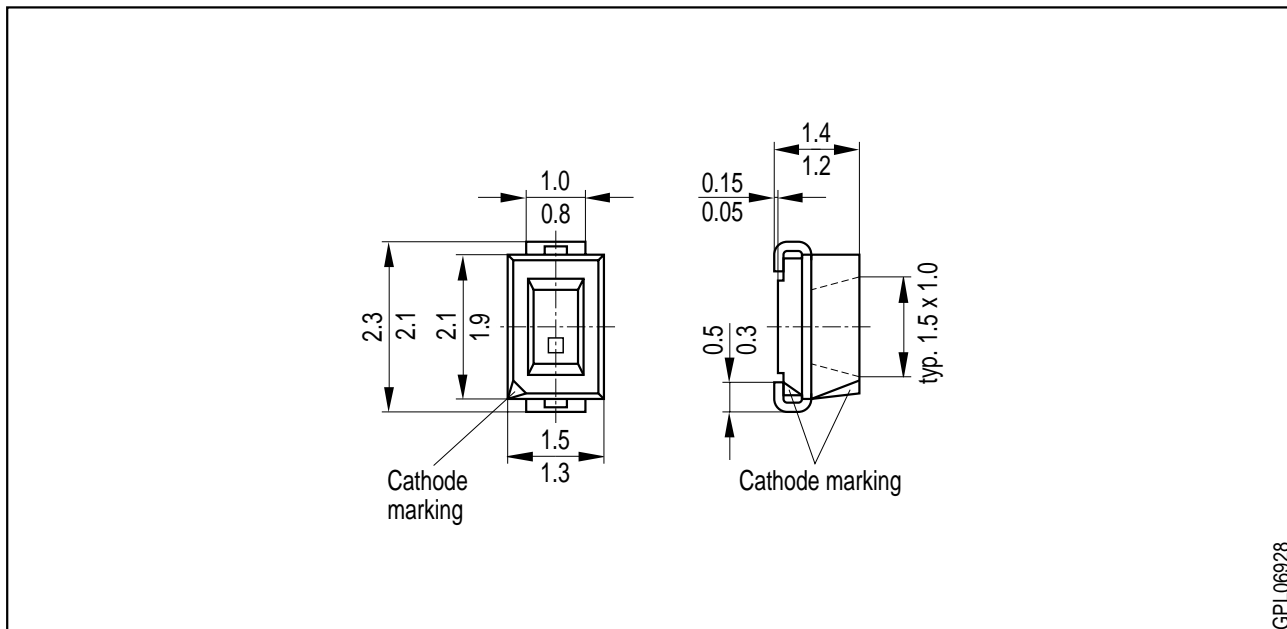

GPL06928

**Kathodenkennung:** abgeschrägte Ecke  
**Cathode mark:** bevelled edge